

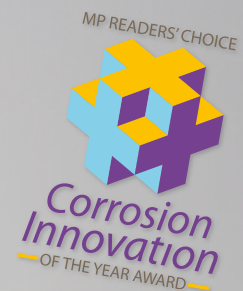

Local Solutions For Individual Customers Worldwide

ACT CLAMP

anti corrosion technology

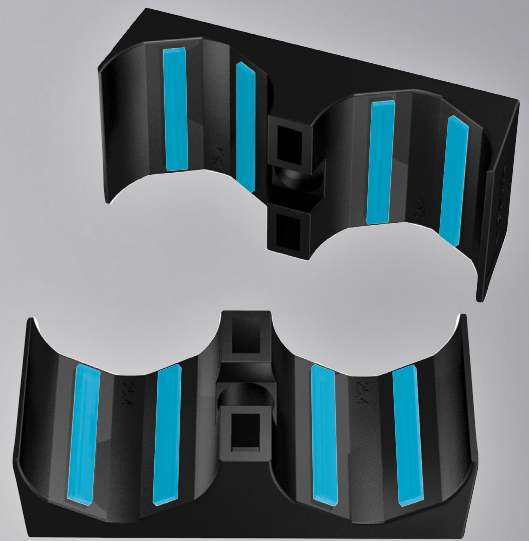

STAUFF ACT Clamps
STAUFF ACT Mounting Hardware
Anti-Corrosion Technology
Product Catalogue ■ Edition 11/2013



Instrumentation pipework made of stainless steel

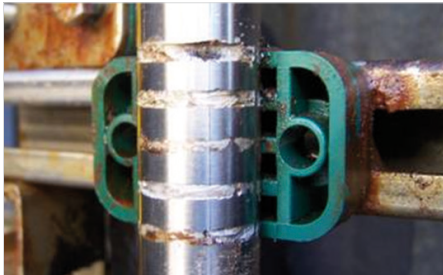

Crevice corrosion formed under a regular plastic clamp

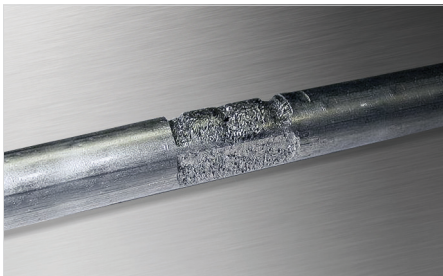

Crevice corrosion formed under a regular plastic clamp



Stainless Steel Pipework

Stainless steel pipework on offshore oil and gas platforms is used over a wide range of temperature, flow and pressure conditions, e.g. for process instrumentation and sensing, as well as for chemical inhibition, hydraulic or utility lines.

The typical tubing material selected for these particular applications is AISI 316 stainless steel, although in more recent times other tube materials have been utilized to try and counteract the offshore corrosion issue.

In all major offshore oil and gas regions – including the Gulf of Mexico, the North Sea, the Gulf of Guinea and the China Sea – corrosion of AISI 316 stainless steel pipework can be observed, and has been a researched and well documented problem as well as a costly and time consuming issue with regard to maintenance processes for many years.

Pitting Corrosion

One of the most prevalent forms of localised corrosion is pitting corrosion: Under certain specific conditions – particularly involving chlorides (such as sodium chloride in seawater) and exacerbated by elevated temperatures – small pits can form in a stainless steel surface.

Dependent upon both the environment and the stainless steel itself, these pits may continue to grow and eventually lead to perforation of tubing walls and leaks, while the majority of the surface may still be totally unaffected.

Pitting corrosion is often quite easy to recognise: small individual pits and – in later stages – sometimes deeper and connected pits can be observed by visual inspection with the unaided eye.

Crevice Corrosion

Another dominant type is crevice corrosion, which is a lot more difficult to observe: It usually tends to occur in shielded areas such as crevices, formed under gaskets, washers, fastener heads, insulating material, surface deposits, disbonded coatings, threads and lap joints.

Pipe clamps made of plastic in particular have also been prone to inducing crevice corrosion in the past, because the plastic deforms around the tubing and creates even tighter crevices.

Crevice corrosion is always initiated by changes in the local chemistry within the shielded area, usually associated with a stagnant solution on the micro-environmental level:

- Trapped seawater becomes stagnant
- Depletion of inhibitor and oxygen
- A shift to acid conditions
- Build-up of aggressive ion species (such as sodium chloride in seawater)
- Accelerated corrosion process

Crevice corrosion can have serious and adverse consequences eventually leading to perforation of tubing walls and the escape of highly flammable fluids and chemicals.

Material Selection

Hence, the selection of proper materials and the use of robust design and safe construction practices are mandatory, even if crevices are sometimes difficult or even impossible to avoid in tubing installations when using regular types of tubing supports and clamps.

And this is where the STAUFF ACT Clamp comes into play ...

Corrosion Facts

Corrosion in general is a naturally occurring phenomenon commonly defined as the deterioration of a substance (usually a metal) or its properties because of a reaction with its environment. Like other natural hazards, corrosion can cause not only expensive but also dangerous damage to almost everything from automobiles, home appliances and drinking water systems to pipelines, bridges and public buildings.

Figures provided by the U.S. National Climatic Data Center underline that major weather related disasters the U.S. incurred total losses of averaging USD 17 billion annually (1980 – 2001). According to U.S. corrosion studies, the estimated direct cost of metallic corrosion in general was USD 276 billion on an annual basis in 1998. This represented 3,1% of the U.S. Gross Domestic Product.

Direct corrosion costs associated with the domestic oil and gas production activities in the U.S. were determined to be about USD 1,4 billion annually, with USD 0,6 billion attributed to surface piping and facility costs, USD 0,5 billion to downhole tubing, and USD 0,3 billion to capital expenditures related to corrosion.

The U.S. refineries represent approximately 23% of the world's petroleum production in 1996 supplying more than 18 million barrels of refined petroleum products per day, with a total corrosion related direct cost of USD 3,7 billion. Maintenance expenses make up USD 1,8 billion of this total, vessel expenses are USD 1,4 billion and fouling costs are approximately USD 0,5 billion annually.

Source of Information: Report No. FHWA-RD-01-156, September 2001 **Corrosion Costs and Preventive Strategies in the United States** Report by CC Technologies Laboratories, Inc. to Federal Highway Administration Office of Infrastructure Research and Development

Main Features

Efficient Prevention of Crevice Corrosion under Pipe Clamps on Stainless Steel Pipework
Middle- and Long-Term Cost Savings due to Extended Service and Maintenance Intervals

Construction based on STAUFF Clamps

- Design based on Original STAUFF Clamps according to DIN 3015, Parts 1 and 3 (Standard Series and Twin Series), the tried and tested industry standard for several decades
- Covering the most commonly used metric and imperial pipe diameters from 6 mm to 25,4 mm (from 1/4 inch to 1 inch)
- Alternative configurations and pipe diameters on request
- Installation time reduction (compared to alternative designs)

Independent Testing and Approval

- Subject to stringent testing at the STAUFF in-house laboratories located in Werdohl (Germany)
- Salt spray tests according to ASTM B117 applied in controlled laboratory environments
- Long-term field tested on a rig in the Dutch sector of the North Sea
- Tests results independently assessed by Centre for Corrosion Technology at Sheffield Hallam University
- Fully detailed, independent test reports available on request

Innovative Design and Materials

- Material and design in compliance with section 7.3 (Tubing Installation) of the Norwegian offshore standard Norsok Z-010 (Revision 3, published in October 2000), API RP 552 and NACE SP 0108-2008 (section 13)
- 1 Clamp body made of flame-retardant PPVO plastic material; tested and VO classified according to UL 94
- 2 Integrated ACE anti-corrosion elastomer strips avoid the accumulation of seawater between clamp body and pipe
- 3 Drainage channels aid the dispersal of seawater

- 4 ACT Mounting Hardware is made of Stainless Steel V4A (Material Code: W55) with enhanced corrosion resistance by practically excluding metallic and non-metallic impurities during production, processing and handling (only delivered in complete packaging units of 25 pieces per bag to avoid contamination during transport)
- High UV stability of the clamp body material; resistant against seawater, rain and oil
- Suitable for continuous exposure to temperatures from -25 °C to +80 °C (from -13 °F to +176 °F)
- To be used in sub-sea and top-side environments; alleviating the requirement for two different products



MP READERS' CHOICE



Corrosion
Innovation
OF THE YEAR AWARD

Technology protected
by utility model patent

Design

STAUFF ACT Clamps are an innovatively designed solution for the installation of instrumentation pipework where anti-corrosion properties are of paramount importance (e.g. in the fields of offshore oil and gas exploration and processing).

The design – based on the tried and tested STAUFF Clamps according to DIN 3015 – offers installation time reduction and long term cost savings due to extended service intervals.

The STAUFF ACT clamp body design is available for the Standard Series (DIN 3015, Part 1) and the Twin Series (DIN 3015, Part 3) to cover the most commonly used metric and imperial pipe diameters from 6 mm to 25,4 mm (1/4 inch to 1 inch).

Development

Throughout their development, STAUFF ACT Clamps have been subject to stringent testing at the STAUFF in-house laboratories located in Werdohl, Germany.

In order to ensure credibility of the product, the development process has also involved independent testing.



To achieve this, the services of the Centre for Corrosion Technology at Sheffield Hallam University's Materials and Engineering Research Institute have been utilized, applying advanced techniques with equipment such as high resolution surface metrology and form measurement systems.

In a controlled laboratory environment, continuous hot salt spray tests according to ASTM B117 have been applied for periods of 2000 hours to various clamp configurations holding AISI 316 stainless steel tubing.

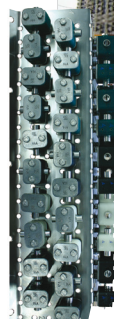

In addition to that, independent field test samples – located on an oil rig in the Dutch sector of the North Sea – have also been assessed at the Sheffield Hallam University facilities.

Both independent tests have recorded positive results in favour of the anti-corrosion attributes of the STAUFF ACT Clamp. Fully detailed test reports are available upon request.

Conformity

Using flame-retardant PPVO plastic material for the clamp body and ACE anti-corrosion elastomer material for the rubber strips, STAUFF ACT Clamps have been constructed in compliance with section 7.3 (Tubing Installation) of the Norwegian offshore standard Norsok Z-010 (Revision 3, published in October 2000), API RP 552 and NACE SP 0108-2008 (section 13).

The Norsok Organisation



Norsok is a Norwegian industry initiative to add value, reduce cost and lead time and remove unnecessary activities in offshore field developments and operations.

The Norsok standards are developed by the Norwegian petroleum industry and are jointly issued by the Norwegian Oil Industry Association (OLF) and the Federation of Norwegian Engineering Industries (TBL). They are administered by the Norwegian Technology Standards Institution (NTS).

The purpose of the Norsok industry standards is to replace the individual oil company specifications for use in existing and future petroleum industry developments, subject to the individual company's review and application.

The Norsok standard Z-010 (Revision 3) published in October 2000 (Section 7.3: Tubing Installation) states the following:

"Tubing clamps shall be made of non-corrosive material, stainless steel AISI 316 and/or flame retardant plastic. Galvanic corrosion between tubing and tubing support system shall be avoided.

The tubing clamp shall, when installed, not allow for water / seawater to be accumulated between tubing and tubing clamp on wall, this is to avoid crevice corrosion."

Clamp Body

Type ACT

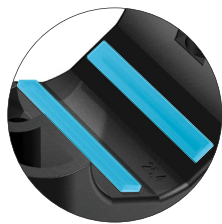

Integrated Rubber Strips
made of Anti-Corrosion Elastomer (ACE)

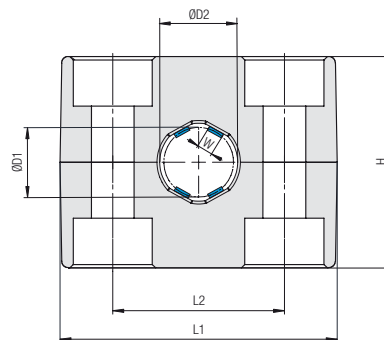

Order Codes

Clamp Body

Clamp Body, STAUFF Group 1A

***2*12,7*ACT**

***1*06,4*ACT**

One clamp body consists of two identical clamp halves, each with two integrated rubber strips.

* STAUFF Group

2

* Exact outside diameter Ø D1 (mm)

12,7

* Material code

ACT

Group Size		Outside Diameter Ø D1		Ordering Code	Packaging Unit	Dimensions (mm/in)					
STAUFF	DIN	(mm)	(in)	(2 Clamp Halves)	(in Pieces / Bag)	ØD2	W	L1	L2	H	Width
1A	1	6		106A ACT (1130029112)	25	9 .35	1,4 .06				
		6,4	1/4	106,4A ACT (1130029113)	25	9,4 .37	1,5 .06				
		8		108A ACT (1130031766)	25	11,0 .43	1,8 .07				
		9,5	3/8	109,5A ACT (1130029114)	25	12,5 .49	2,2 .09	37 1.46	20 .79	26 1.06	30 1.18
		10		110A ACT (1130029115)	25	13 .51	2,3 .09				
		12		112A ACT (1130029116)	25	15 .59	2,8 .11				
2	2	12,7	1/2	212,7 ACT (1130029117)	25	15,7 .62	3,5 .14				
		14		214 ACT (1130029118)	25	17 .67	3,5 .14				
		14,3	9/16	214,3 ACT (1130031013)	25	17,3 .68	3,5 .14	42 1.65	26 1.02	32 1.30	30 1.18
		16	5/8	216 ACT (1130031455)	25	19 .74	3,5 .14				
		18		218 ACT (1130029119)	25	21 .83	3,5 .14				
3	3	19	3/4	319 ACT (1130029120)	25	22 .87	3,5 .14				
		20		320 ACT (1130029121)	25	23 .91	3,5 .14				
		21,3		321,3 ACT (1130029122)	25	24,3 .96	3,5 .14	50 1.97	33 1.30	35,5 1.42	30 1.18
		25		325 ACT (1130030925)	25	28 1.10	3,5 .14				
		25,4	1	325,4 ACT (1130029123)	25	28,4 1.12	3,5 .14				

Additional sizes and outside diameters are available upon request.
Please consult STAUFF for further information.



ACT Mounting Hardware Installation on Single Weld Plates

Required components:

- 2 ACT Hexagon Head Bolts AS...W55
- 1 ACT Cover Plate DP...W55
- 1 ACT Clamp Body (2 Clamp Halves)
- 1 ACT Single Weld Plate SP...W55

Before welding, always make sure that the designated position of the ACT Weld Plate is suitable for the expected loads.

Material Code
W55

ACT Mounting Hardware Material Properties and Handling Instructions

ACT Mounting Hardware is made of Stainless Steel V4A (Material Code: W55) with enhanced corrosion resistance by practically excluding metallic and non-metallic impurities during production, processing and handling.

ACT Mounting Hardware is only delivered in complete packaging units of 25 pieces per bag to avoid contamination during transport.

Always make sure that ACT Mounting Hardware is stored separately from carbon steel and any other metals, and that appropriate tools are used to assemble the clamps.

ACT Hexagon Head Bolt

Type AS ... W55 (according to DIN 931 / 933)



Dimensions applicable only when used with Cover Plate DP and Weld Plate SP



Group	STAUFF	DIN	Dimensions (mm/in) Thread G x L	Order Code	Packaging Unit (in Pieces / Bag)
1A	1		M6 x 30	AS 1A M W55 (1130030403)	25
			M6 x 1.18		
2	2		M6 x 35	AS 2 M W55 (1130030404)	25
			M6 x 1.38		
3	3		M6 x 40	AS 3 M W55 (1130030405)	25
			M6 x 1.57		

ACT Cover Plate

Type DP ... W55

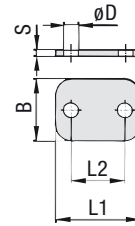

Group	STAUFF	DIN	Dimensions (mm/in)					Order Code	Packaging Unit (in Pieces / Bag)
			L1	L2	B	S	ØD		
1A	1		34	20	30	3	7	DP 1A W55 (1130030398)	25
			1.34	.79	1.18	.12	.28		
2	2		40,5	26	30	3	7	DP 2 W55 (1130030399)	25
			1.59	1.02	1.18	.12	.28		
3	3		48	33	30	3	7	DP 3 W55 (1130030400)	25
			1.89	1.30	1.18	.12	.28		

Single Weld Plate

Type SP ... W55

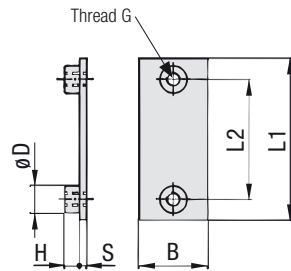
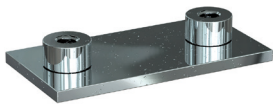

Group	STAUFF	DIN	Dimensions (mm/in)						Order Code	Packaging Unit (in Pieces / Bag)	
			G	L1	L2	B	S	H	ØD		
1A	1		M6	36	20	30	3	6,5	12	SP 1A M W55 (1120023234)	25
				1.42	0.79	1.18	.12	.26	.47		
2	2		M6	42	26	30	3	6,5	12	SP 2 M W55 (1120023235)	25
				1.65	1.02	1.18	.12	.26	.47		
3	3		M6	50	33	30	3	6,5	12	SP 3 M W55 (1120023235)	25
				1.97	1.30	1.18	.12	.26	.47		

ACT Mounting Hardware Installation in Field Trays / Cable Ladders

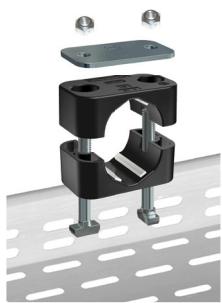

Required components:

- 2 ACT Self-Locking Nuts MUS-HKS ... W55
- 1 ACT Cover Plate DP ... W55
- 1 ACT Clamp Body (2 Clamp Halves)
- 2 ACT Hammerhead Bolts HKS ... W55

Suitable for commonly used field trays and cable ladders with diagonal, lengthwise and/or crosswise slots and perforations.

Material Code **W55** ACT Mounting Hardware Material Properties and Handling Instructions

ACT Mounting Hardware is made of Stainless Steel V4A (Material Code: W55) with enhanced corrosion resistance by practically excluding metallic and non-metallic impurities during production, processing and handling.

ACT Mounting Hardware is only delivered in complete packaging units of 25 pieces per bag to avoid contamination during transport.

Always make sure that ACT Mounting Hardware is stored separately from carbon steel and any other metals, and that appropriate tools are used to assemble the clamps.

NEW All-Metal Self-Locking ACT Nut Type MUS-HKS ... W55 (similar to DIN 980 / Biloc)

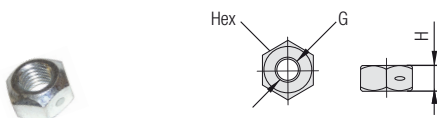

For use with ACT Hammerhead Bolts HKS ... W55

Group	STAUFF	DIN	Dimensions (mm/in)			Order Codes	Packaging Unit
			Thread G	H	Hex		(in Pieces / Bag)
1A	1						
2	2		M6	5 .20	10 .39	MUS-HKS M6 W55 (1130030998)	25
3	3						

ACT Cover Plate Type DP ... W55

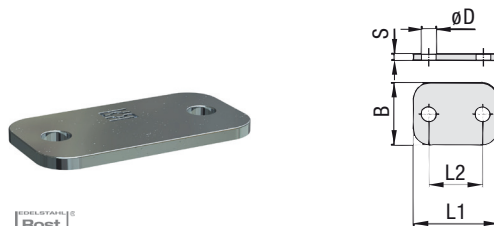

Group	STAUFF	DIN	Dimensions (mm/in)					Order Code	Packaging Unit
			L1	L2	B	S	ØD		(in Pieces / Bag)
1A	1		34 1.34	20 .79	30 1.18	3 .12	7 .28	DP 1A W55 (1130030398)	25
2	2		40,5 1.59	26 1.02	30 1.18	3 .12	7 .28	DP 2 W55 (1130030399)	25
3	3		48 1.89	33 1.30	30 1.18	3 .12	7 .28	DP 3 W55 (1130030400)	25

NEW ACT Hammerhead Bolt Type HKS ... W55

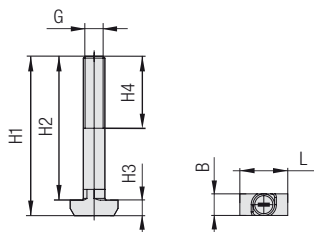

For use with Self-Locking ACT Nuts MUS-HKS ... W55

Group	STAUFF	DIN	Dimensions (mm/in)							Order Codes	Packaging Unit
			G	H1	H2	H3	H4 _{min}	B	L		(in Pcs. / Bag)
1A	1		M6	44,3 1.74	40 1.57	4,3 .17	20 .79	6,1 .24	13,3 .52	HKS M6x40 W55 (1130030408)	25
2	2		M6	49,3 1.94	45 1.77	4,3 .17	20 .79	6,1 .24	13,3 .52	HKS M6x45 W55 (1130030409)	25
3	3		M6	54,3 2.14	50 1.97	4,3 .17	20 .79	6,1 .24	13,3 .52	HKS M6x50 W55 (1130030410)	25

Suitability Chart for ACT Hammerhead Bolts in the Standard Series

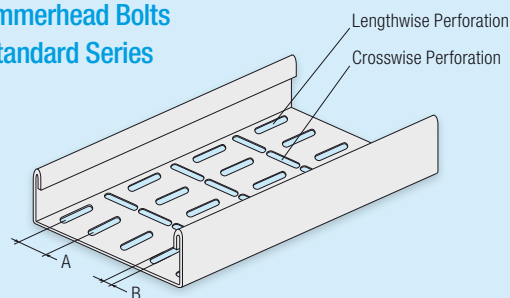

ACT Hammerhead Bolts are suitable for field trays and cable ladders with diagonal, lengthwise and/or crosswise slots and perforations that meet the following requirements:

- **Dimension A:** Equal to the bolt center spacing of the clamp assembly
- **Dimension B:** 6,2 mm ... 7,0 mm / .24 in28 in (Min ... Max)

In case of doubt, please do not hesitate to contact STAUFF prior to field application.

Order Examples



Material Code W55 ACT Mounting Hardware is made of Stainless Steel V4A (Material Code: W55) with enhanced corrosion resistance by practically excluding metallic and non-metallic impurities during production, processing and handling.

ACT Mounting Hardware is only delivered in complete packaging units of 25 pieces per bag to avoid contamination during transport.

Always make sure that ACT Mounting Hardware is stored separately from carbon steel and any other metals, and that appropriate tools are used to assemble the clamps.

① Type of Installation

Please select the type of installation and add the corresponding Code to position ① of the order code for your clamp assembly.

Single Weld Plate
(for use with Cover Plate DP and Hexagon Head Bolts AS)
Code: **SP**

Hammerhead Bolts
(for use with Cover Plate DP and Self-Locking Nuts MUS-HKS)
Code: **HKS**

② Group Size & Diameter

Please select the required group size and diameter and add the corresponding Code to position ② of the order code for your clamp assembly.

Größe STAUFF	DIN	Außendurchmesser (mm)	(in)	Code
1A	1	6		106A
		6,4	1/4	106,4A
		8		108A
		9,5	3/8	109,5A
		10		110A
		12		112A
2	2	12,7	1/2	212,7
		14		214
		14,3	9/16	214,3
		16	5/8	216
		18		218
3	3	19	3/4	319
		20		320
		21,3		321,3
		25		325
		25,4	1	325,4

Additional outside diameters are available upon request. Please consult STAUFF for further information.

③ Mounting & Fitting Combination

Please select the mounting and fitting combination and add the corresponding Code to position ③ of the order code for your clamp assembly.

Installation with Cover Plate and Hexagon Head Bolts

Cover Plate DP with Hexagon Head Bolts AS
Code: **DP-AS**

Installation with Cover Plate and Self-Locking Nuts

Cover Plate DP with Self-Locking Nuts MUS-HKS
Code: **DP-MUS**

④ Assembling & Kitting

If required, please select an additional assembling and kitting option and add the corresponding Code to the last position of the order code for your clamp assembly.

Components supplied separately
Code: **none** (standard option)

Components assembled
Code: **#A** (special option)

Components packed in kits
Code: **#K** (special option)

Only delivered in complete packaging units of 25 pieces per bag to avoid contamination during transport.

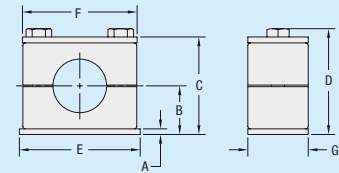

Dimensions of Clamp Assemblies

Group STF.	DIN	Dimensions (mm/in)						
		A	B	C	D	E	F	G
1A	1	3	16	32	36	36	34	30
		.12	.63	1.26	1.42	1.41	1.33	1.18
2	2	3	19	38	42	42	40,5	30
		.12	.75	1.50	1.65	1.65	1.59	1.18
3	3	3	20,75	41,5	45,5	50	48	30
		.12	.82	1.64	1.80	1.96	1.88	1.18

Weights of Clamp Assemblies

	STAUFF / DIN Group Size		
	1A / 1	2 / 2	3 / 3
Weight / 100 Pcs. (kg/lbs)	8,10	9,40	11,20
	17.82	20.68	24.64

Dimensions and weights for clamp assemblies including Weld Plate SP, Cover Plate DP and Hexagon Head Bolts AS.

Spacing and Positioning of STAUFF Clamps

In order to conform with the Norwegian offshore standard Norsok Z-010, correct spacing of pipe and tube clamps has to be observed. The following recommendations are made:

[...] Instrument tubing shall be supported to field trays or cable ladders for tubing sizes less than 16 mm outside diameter. Cable tray, ladder or equal to be used for larger sizes when mechanical protection is required. [...]

Tubing to be fastened to self drained tubing clamps with span max every 60x tubing diameter (in millimeters). Tubing sizes above 25 mm (.98 in) outside diameter shall as a minimum have support every 1500 mm (4.92 ft). [...]

Please also note the following information on the installation of STAUFF Clamps next to pipe bends, tube fittings and/or valves:

Pipe bends should be supported by STAUFF Clamps positioned as close to the bends as possible.

If tube fittings and/or valves are incorporated in the pipeline system, it is recommended that support is provided by STAUFF Clamps located directly next to these components to protect them from vibrations.

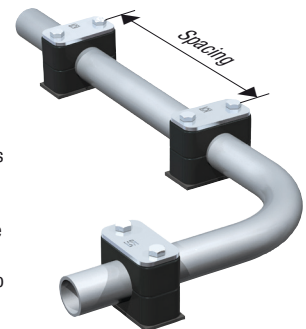

Clamp Body

Type ACT

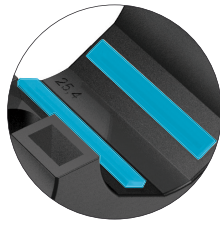

Integrated Rubber Strips
made of Anti-Corrosion Elastomer (ACE)

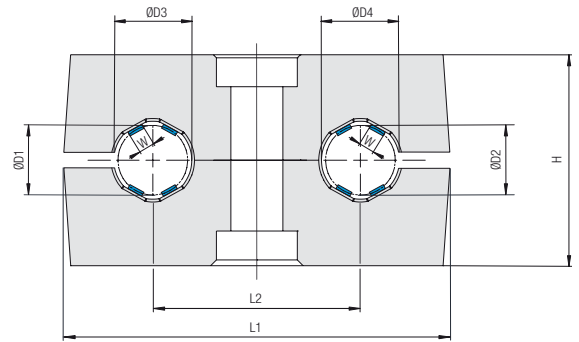

Order Codes

Clamp Body

***2*12,7/12,7*ACT**

One clamp body consists of two identical clamp halves, each with four integrated rubber strips.

- * 1st Part of STAUFF Group **2**
- * Exact outside diameters Ø D1 / Ø D2 (mm) **12,7 / 12,7**
- * Material code **ACT**

Group Size		Outside Diameters Ø D1 / Ø D2 (mm) (in)		Ordering Code (2 Clamp Halves)	Packaging Unit (in Pieces / Bag)	Dimensions (mm/in)						
STAUFF	DIN					ØD3/ ØD4	W	L1	L2	H	Width	
1D	1	6		106/06 ACT (1130029765)	25	9 .35	1,4 .06					
		6,4	1/4	106,4/6,4 ACT (1130029766)	25	9,4 .37	1,5 .06					
		9,5	3/8	109,5/9,5 ACT (1130029767)	25	12,5 .49	2,2 .09	36 1.42	20 .79	26 1.02	30 1.18	
		10		110/10 ACT (1130029768)	25	13 .51	2,3 .09					
		12		112/12 ACT (1130029769)	25	15 .59	2,8 .11					
2D	2	12,7	1/2	212,7/12,7 ACT (1130029771)	25	15,7 .62	3,5 .14	53 2.09	29 1.14	32 1.26	30 1.18	
		14		214/14 ACT (1130029772)	25	17 .67	3,5 .14					
3D	3	18		318/18 ACT (1130029747)	25	21 .83	3,5 .14					
		19	3/4	319/19 ACT (1130029748)	25	22 .87	3,5 .14					
		20		320/20 ACT (1130029749)	25	23 .91	3,5 .14	67 2.64	36 1.42	35,5 1.40	30 1.18	
		21,3		321,3/21,3 ACT (1130029750)	25	24,3 .96	3,5 .14					
		25,4	1	325,4/25,4 ACT (1130029751)	25	28,4 1.12	3,5 .14					

Additional outside diameters and combinations of different outside diameters are available upon request.
Please consult STAUFF for further information.

ACT Mounting Hardware Installation on Single Weld Plates



Required components:

- 1 ACT Hexagon Head Bolt AS...W55
- 1 ACT Cover Plate GD...W55
- 1 ACT Clamp Body (2 Clamp Halves)
- 1 ACT Single Weld Plate SP...W55

Before welding, always make sure that the designated position of the ACT Weld Plate is suitable for the expected loads.

Material Code **W55** ACT Mounting Hardware Material Properties

ACT Mounting Hardware is made of Stainless Steel V4A (Material Code: W55) with enhanced corrosion resistance by practically excluding metallic and non-metallic impurities during production, processing and handling.

ACT Mounting Hardware is only delivered in complete packaging units of 25 pieces per bag to avoid contamination during transport.

Always make sure that ACT Mounting Hardware is stored separately from carbon steel and any other metals, and that appropriate tools are used to assemble the clamps.

ACT Hexagon Head Bolt Type AS ... W55 (according to DIN 931 / 933)



Dimensions applicable only when used with Cover Plate GD and Weld Plate SP



Group	STAUFF	DIN	Dimensions (mm/in) Thread G x L	Order Codes	Packaging Unit (in Pieces / Bag)
1D	1		M6 x 35	AS 1D M W55 (1130030404)	25
			M6 x 1.38		
2D	2		M8 x 35	AS 2D M W55 (1130030419)	25
			M8 x 1.38		
3D	3		M8 x 45	AS 3D M W55 (1130030420)	25
			M8 x 1.77		

ACT Cover Plate Type GD ... W55

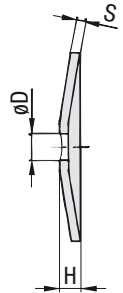
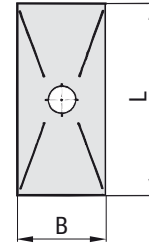

Group	STAUFF	DIN	Dimensions (mm/in)					Order Codes	Packaging Unit (in Pieces / Bag)
			L	B	H	S	ØD		
1D	1		34	30	7	3	7	GD 1D W55 (1130030413)	25
			1.34	1.18	.28	.12	.28		
2D	2		52	30	7	3	9	GD 2D W55 (1130030414)	25
			2.05	1.18	.28	.12	.35		
3D	3		65	30	7	3	9	GD 3D W55 (1130030415)	25
			2.56	1.18	.28	.12	.35		

Single Weld Plate Type SP ... W55

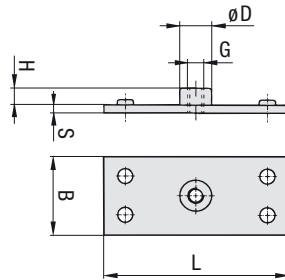
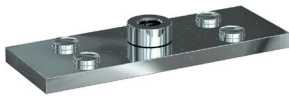

Group	STAUFF	DIN	Dimensions (mm/in)					Order Code	Packaging Unit (in Pieces / Bag)	
			G	L	B	S	H	ØD		
1D	1		M6	37	30	3	6.5	12	SP 1D M W55 (1120023239)	25
				1.46	1.18	.12	.26	.47		
2D	2		M8	55	30	5	6	14	SP 2D M W55 (1120023240)	25
				2.17	1.18	.20	.24	.55		
3D	3		M8	70	30	5	6	14	SP 3D M W55 (1120023241)	25
				2.76	1.18	.20	.24	.55		

ACT Mounting Hardware Installation in Field Trays / Cable Ladders

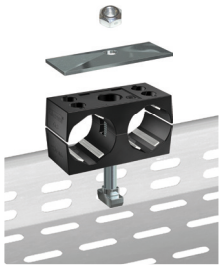

Required components:

- 1 ACT Self-Locking Nut MUS-HKS ... W55
- 1 ACT Cover Plate GD ... W55
- 1 ACT Clamp Body (2 Clamp Halves)
- 1 ACT Hammerhead Bolt HKS ... W55

Suitable for commonly used field trays and cable ladders with diagonal, lengthwise and/or crosswise slots and perforations.

Material Code **W55** ACT Mounting Hardware Material Properties

ACT Mounting Hardware is made of Stainless Steel V4A (Material Code: W55) with enhanced corrosion resistance by practically excluding metallic and non-metallic impurities during production, processing and handling.

ACT Mounting Hardware is only delivered in complete packaging units of 25 pieces per bag to avoid contamination during transport.

Always make sure that ACT Mounting Hardware is stored separately from carbon steel and any other metals, and that appropriate tools are used to assemble the clamps.

NEW All-Metal Self-Locking ACT Nut Type MUS-HKS ... W55 (similar to DIN 980 / Biloc)

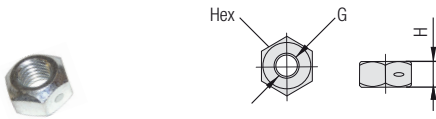

For use with ACT Hammerhead Bolts HKS ... W55

Group	STAUFF	DIN	Dimensions (mm/in)			Order Codes	Packaging Unit (in Pieces / Bag)
			Thread G	H	Hex		
1D	1	M6	5 .20	10 .39		MUS-HKS M6 W55 (1130030998)	25
2D	2	M8	6,5 .26	13 .51		MUS-HKS M8 W55 (1130031210)	25
3D	3						

ACT Cover Plate Type GD ... W55

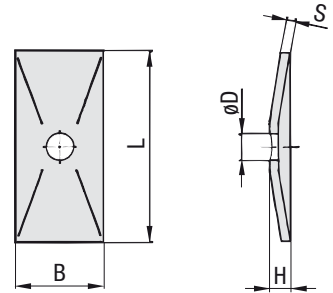

Group	STAUFF	DIN	Dimensions (mm/in)					Order Codes	Packaging Unit (in Pieces / Bag)
			L	B	H	S	ØD		
1D	1		34 1.34	30 1.18	7 .28	3 .12	7 .28	GD 1D W55 (1130030413)	25
2D	2		52 2.05	30 1.18	7 .28	3 .12	9 .35	GD 2D W55 (1130030414)	25
3D	3		65 2.56	30 1.18	7 .28	3 .12	9 .35	GD 3D W55 (1130030415)	25

NEW ACT Hammerhead Bolt Type HKS ... W55

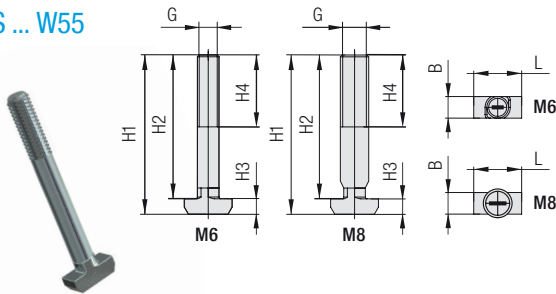

For use with Self-Locking ACT Nuts MUS-HKS ... W55

Group	STAUFF	DIN	Dimensions (mm/in)							Order Codes	Packaging Unit (in Pcs. / Bag)
			G	H1	H2	H3	H4 _{min}	B	L		
1D	1	M6	49,3 1.94	45 1.77	4,3 .17	20 .79	6,1 .24	13,3 .52		HKS M6x45 W55 (1130030409)	25
2D	2	M8	49,3 1.94	45 1.77	4,3 .17	20 .79	6 .24	13,3 .52		HKS M8x45 W55 (1130030423)	25
3D	3	M8	59,3 2.33	55 2.17	4,3 .17	20 .79	6 .24	13,3 .52		HKS M8x55 W55 (1130030424)	25

Suitability Chart for ACT Hammerhead Bolts in the Twin Series

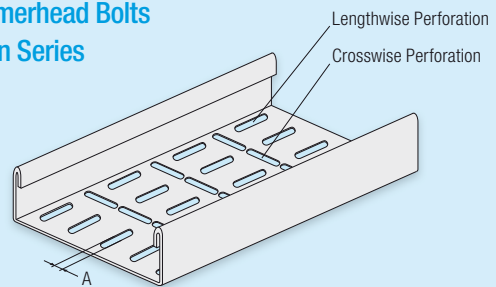

ACT Hammerhead Bolts are suitable for field trays and cable ladders with diagonal, lengthwise and/or crosswise slots and perforations that meet the following requirements:

- **Dimension A:** 6,2 mm ... 7,0 mm / .24 in28 in (Min ... Max)

In case of doubt, please do not hesitate to contact STAUFF prior to field application.

Order Examples

SP 212,7/12,7 ACT GD-AS M W55 #K

1 2 3 4

HKS 212,7/12,7 ACT GD-MUS M W55 #K

1 2 3 4

Material Code ACT Mounting Hardware is made of Stainless Steel V4A (Material Code: W55) with enhanced corrosion resistance by practically excluding metallic and non-metallic impurities during production, processing and handling.

ACT Mounting Hardware is only delivered in complete packaging units of 25 pieces per bag to avoid contamination during transport.

Always make sure that ACT Mounting Hardware is stored separately from carbon steel and any other metals, and that appropriate tools are used to assemble the clamps.

① Type of Installation

Please select the type of installation and add the corresponding Code to position ① of the order code for your clamp assembly.

 Single Weld Plate
 (for use with Cover Plate GD and Hexagon Head Bolt AS)
 Code: **SP**

 Hammerhead Bolt
 (for use with Cover Plate GD and Self-Locking Nut MUS-HKS)
 Code: **HKS**

② Group Size & Diameter

Please select the required group size and diameters and add the corresponding Code to position ② of the order code for your clamp assembly.

Group Size	STAUFF	DIN	Outside Diameters		Code
			(mm)	(in)	
1D	1		6		106/06
			6,4	1/4	106,4/6,4
			9,5	3/8	109,5/9,5
			10		110/10
			12		112/12
2D	2		12,7	1/2	212,7/12,7
			14		214/14
			18		318/18
3D	3		19	3/4	319/19
			20		320/20
			21,3		321,3/21,3
			25,4	1	325,4/25,4

Additional outside diameters are available upon request. Please consult STAUFF for further information.

③ Mounting & Fitting Combination

Please select the mounting and fitting combination and add the corresponding Code to position ③ of the order code for your clamp assembly.

Installation with Cover Plate and Hexagon Head Bolt

 Cover Plate GD with Hexagon Head Bolt AS
 Code: **GD-AS**

Installation with Cover Plate and Self-Locking Nut

 Cover Plate GD with Self-Locking Nut MUS-HKS
 Code: **GD-MUS**

④ Assembling & Kitting

If required, please select an additional assembling and kitting option and add the corresponding Code to the last position of the order code for your clamp assembly.

Components supplied separately
 Code: **none** (standard option)

Components assembled
 Code: **#A** (special option)

Components packed in kits
 Code: **#K** (special option)

Only delivered in complete packaging units of 25 pieces per bag to avoid contamination during transport.

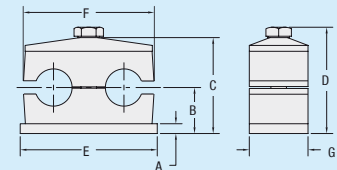

Dimensions of Clamp Assemblies

Group	STF.	DIN	Dimensions (mm/in)						
			A	B	C	D	E	F	G
1D	1		3	16,5	37	41	37	36	30
			.12	.65	1.46	1.61	1.46	1.42	1.18
2D	2		5	18,5	39	44	55	53	30
			.20	.73	1.54	1.73	2.17	2.09	1.18
3D	3		5	23,5	49	54	70	67	30
			.20	.93	1.93	2.13	2.76	2.64	1.18

Weights of Clamp Assemblies

	STAUFF / DIN Group Size		
	1D / 1	2D / 2	3D / 3
Weight / 100 Pcs. (kg/lbs)	7,60	13,50	17,70
	16.72	29.70	38.94

Dimensions and weights for clamp assemblies including Weld Plate SP, Cover Plate GD and Hexagon Head Bolt AS.

Spacing and Positioning of STAUFF Clamps

In order to conform with the Norwegian offshore standard Norsok Z-010, correct spacing of pipe and tube clamps has to be observed. The following recommendations are made:

[...] Instrument tubing shall be supported to field trays or cable ladders for tubing sizes less than 16 mm outside diameter. Cable tray, ladder or equal to be used for larger sizes when mechanical protection is required. [...]

Tubing to be fastened to self drained tubing clamps with span max every 60x tubing diameter (in millimeters). Tubing sizes above 25 mm (.98 in) outside diameter shall as a minimum have support every 1500 mm (4.92 ft). [...]

Please also note the following information on the installation of STAUFF Clamps next to pipe bends, tube fittings and/or valves:

Pipe bends should be supported by STAUFF Clamps positioned as close to the bends as possible.

If tube fittings and/or valves are incorporated in the pipeline system, it is recommended that support is provided by STAUFF Clamps located directly next to these components to protect them from vibrations.

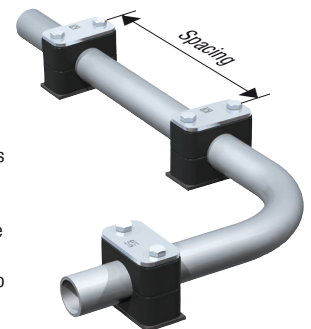



Local Solutions For Individual Customers Worldwide



GERMANY

Walter Stauffenberg GmbH & Co. KG
P. O. Box 1745 • 58777 Werdohl
Im Ehrenfeld 4 • 58791 Werdohl
Tel.: +49 23 92 916 0
Fax: +49 23 92 916 160
act@stauff.com

Globally available through wholly-owned branches and distributors in all major oil and gas regions.



act@stauff.com
www.stauff.com/act

AUSTRALIA

STAUFF Corporation Pty. Ltd.
Tel.: +61 2 4271 18 77
sales@stauff.com.au

BRAZIL

STAUFF Brasil Ltda.
Tel.: +55 11 47 72 72 00
stauff@stauffbrasil.com

CANADA

STAUFF Canada Ltd.
Tel.: +1 416 282 46 08
sales@stauffcanada.com

CHINA

STAUFF China
Tel.: +86 21 68 18 70 00
info@stauff.com.cn

FRANCE

STAUFF S.A.S.
Tel.: +33 2 54 50 55 50
direction@stauffsa.com

INDIA

STAUFF India Pvt. Ltd.
Tel.: +91 20 66 20 2471
sales@stauffindia.com

IRELAND

STAUFF Ireland
Tel.: +44 28 92 60 69 00
sales@stauffireland.com

ITALY

STAUFF Italia s.r.l.
Tel.: +39 0362 63 80 70
sales@stauff.it

KOREA

STAUFF Korea Ltd.
Tel.: +82 51 266 66 66
info@stauff.co.kr

MALAYSIA

STAUFF South East Asia Sdn Bhd
Tel.: +60 3 8024 61 68
sales@stauff.com.my

NEW ZEALAND

STAUFF Corporation (NZ) Ltd.
Tel.: +64 9 271 48 12
info@stauff.co.nz

POLAND

STAUFF Polska Sp. z o.o.
Tel.: +48 58 660 11 60
sales@stauff.pl

RUSSIAN FEDERATION

STAUFF LLC
Moscow Head Office:
Tel.: +7 495 276 16 50
sales@stauff.ru

St. Petersburg Branch Office:
Tel.: +7 812 676 76 53
s.petersburg@stauff.ru

UNITED KINGDOM

STAUFF UK Ltd.
Sheffield Head Office:
Tel.: +44 114 251 85 18
sales@stauff.co.uk

Aberdeen Branch Office:
Tel.: +44 1224 23 85 18
sales@stauffscotland.co.uk

UNITED STATES

STAUFF Corporation
Tel.: +1 201 444 78 00
sales@stauffusa.com

VIETNAM

STAUFF Vietnam Ltd.
Tel.: +84 8 3995 47 23
sales@stauff.com.vn