

Tube Connectors

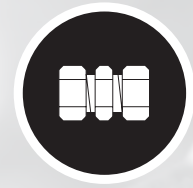

Assembly Tools and Devices



## Germany

### Walter Stauffenberg GmbH & Co. KG

Im Ehrenfeld 4  
58791 Werdohl

[www.stauff.com](http://www.stauff.com)

STAUFF products and services are globally available through wholly-owned subsidiaries and a tight network of authorised distributors and representatives in all major industrial regions of the world.

**You can find detailed contact information on the last two pages of this product catalogue or at [www.stauff.com/contact](http://www.stauff.com/contact).**

Please note: Unless otherwise stated, all data and figures in this product catalogue are approximate values and are only valid as references, which are not binding (also in respect to any third parties' rights of protection) and thus do not release the customer / user from checking and testing the suitability of the products for the foreseen purposes. Therefore, data and figures can only be used in a limited sense for construction purposes.

The application of the products is beyond the control possibilities of the manufacturer and, therefore, is exclusively subject to the responsibility of the customer / user.

In the event that a liability is nevertheless considered, any compensation will be limited to the value of the goods supplied by the manufacturer and used by the customer / user. As a matter of course, the manufacturer guarantees the perfect quality of all products in accordance with the General Terms and Conditions of Business and Sale.

Subject to modifications due to the ongoing development and improvement of the products.

With the publication of this product catalogue, previous editions are no longer valid.

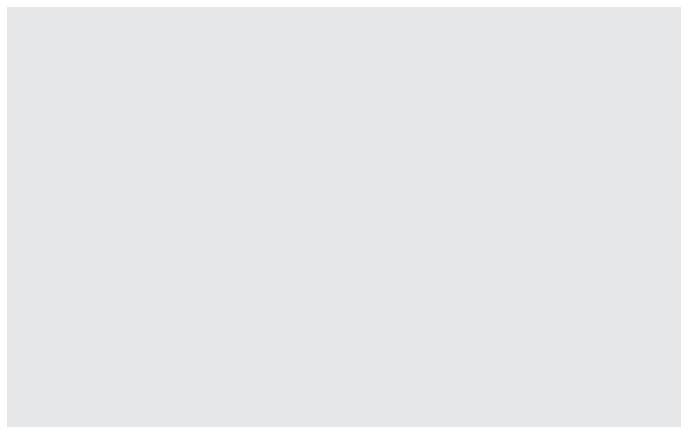
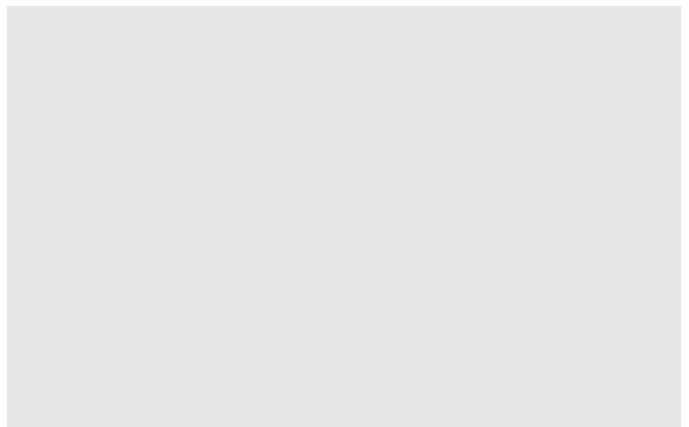

<b>Introduction</b>	4 - 11	
<b>System Overview</b>	12 - 25	<b>A</b>
<b>Connecting Parts</b>	26 - 37	<b>B</b>
<b>Male Stud Fittings</b>	38 - 93	<b>C</b>
<b>Tube Fittings / Unions</b>	94 - 105	<b>D</b>
<b>Bulkhead Fittings</b>	106 - 111	<b>E</b>
<b>Weld Fittings</b>	112 - 121	<b>F</b>
<b>Female Stud / Gauge Fittings</b>	122 - 131	<b>G</b>
<b>Fittings with 24° Taper / O-Ring (DKO)</b>	132 - 153	<b>H</b>
<b>Standpipe Fittings</b>	154 - 169	<b>I</b>
<b>Fittings with Lock Nut</b>	170 - 179	<b>J</b>
<b>Banjo Fittings</b>	180 - 193	<b>K</b>
<b>Swivel Fittings</b>	194 - 197	<b>L</b>
<b>Hydraulic Valves</b>	198 - 217	<b>M</b>
<b>Custom-Designed Solutions</b>	218 - 221	<b>N</b>
<b>Spare Parts / Accessories</b>	222 - 247	<b>O</b>
<b>Assembly Tools / Devices</b>	248 - 273	<b>P</b>
<b>Measuring and Test Equipment</b>	274 - 277	<b>Q</b>
<b>Tube Manipulation</b>	278 - 287	<b>R</b>
<b>Assembly Instructions</b>	288-331	<b>S</b>
<b>Technical Appendix</b>	332 - 343	<b>T</b>
<b>Appendix (Product-Specific Abbreviations / Global Contact Directory)</b>	344 - 351	





### Catalogue 1 STAUFF Clamps

- Block Clamps
- Special Clamps
- Light Series Clamps
- Saddle Clamps
- U-Bolt Clamps
- Metal Clamps
- Construction Series



### Catalogue 2 STAUFF Connect

- Tube Connectors
- Assembly Tools and Devices

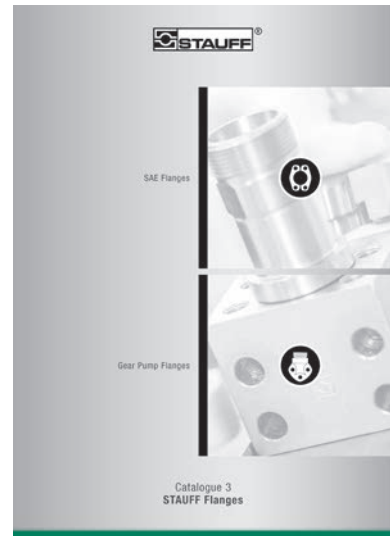

### Catalogue 3 STAUFF Flanges

- SAE Flanges
- Gear Pump Flanges



### Catalogue 4 STAUFF Hose Connectors

- Hose Connectors
- High-Pressure Hose Connectors

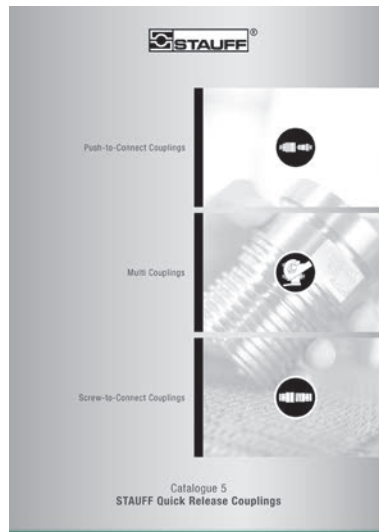

### Catalogue 5 STAUFF Quick Release Couplings

- Push-to-Connect Couplings
- Multi Couplings
- Screw-to-Connect Couplings



### Catalogue 6 STAUFF Valves

- Two-Way Ball Valves
- Multi-Way Ball Valves
- Flow Control and Check Valves
- Gauge Isolator Valves





**Catalogue 7  
STAUFF Test**

- Test Couplings
- Test Adaptors
- Test Hoses and Connectors



**Catalogue 8  
STAUFF Diagtronics**

- Pressure Gauges
- Hydraulic Testers
- Oil Analysis Equipment



**Catalogue 9  
STAUFF Filtration Technology**

- Replacement Filter Elements
- Pressure Filters
- Return-Line Filters
- In-Line Filters
- Spin-On Filters
- Offline and Bypass Filters
- Filtration Systems

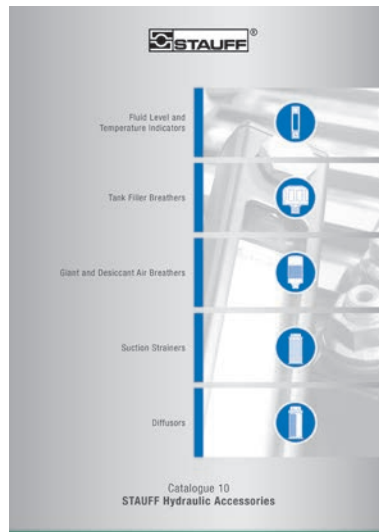

**Catalogue 10  
STAUFF Hydraulic Accessories**

- Fluid Level and Temperature Indicators
- Tank Filler Breathers
- Giant and Desiccant Air Breathers
- Suction Strainers
- Diffusers



For more than 50 years, the companies of STAUFF Group have been developing, manufacturing and distributing pipework equipment and hydraulic components for mechanical and plant engineering and for service and industrial maintenance.

In addition to mobile and industrial hydraulic machinery, typical applications also include commercial and special purpose vehicles, rail transportation and energy technology. Likewise, STAUFF products are used in marine, oil and gas applications and in the process, food and chemical industries.

The overall range currently includes about 50000 standard products as well as numerous special and system solutions according to customer's specifications or based on our in-house development.

All STAUFF products undergo relevant testing in accordance with international regulations and are governed by the high standards of the in-house quality management system. Furthermore, many items have received certifications and approvals from various international institutes, organisations and authorities who have independently confirmed the quality and performance of the products.

Wholly-owned manufacturing, sales and service facilities in 18 countries and a tight global network of authorised distribution partners ensure high presence and service paired with a maximum of availability.



Quality Management – ISO 9001:2015  
Environmental Management – ISO 14001:2015  
Safety Management – ISO 45001:2018  
Energy Management – ISO 50001:2018

## STAUFF LINE Components

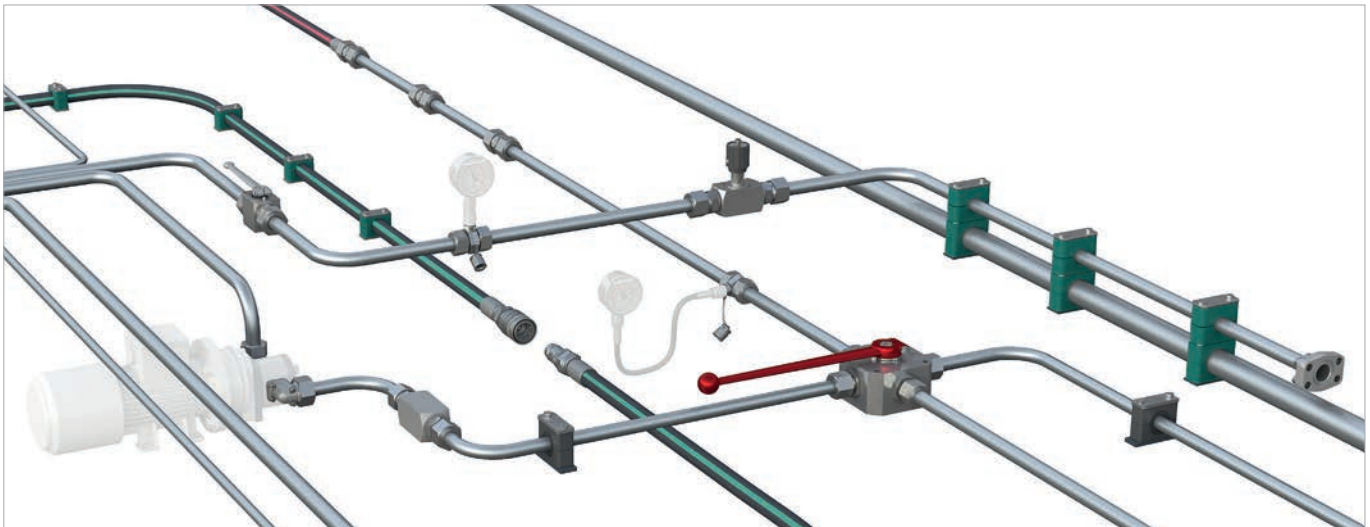

With the seven dedicated **STAUFF Line** product groups

- **STAUFF Clamps**
- **STAUFF Connect**
- **STAUFF Flanges**
- **STAUFF Hose Connectors**
- **STAUFF Quick Release Couplings**
- **STAUFF Valves**
- **STAUFF Test**

from own, in-house development and manufacturing, the companies of the STAUFF Group provide a comprehensive range of components for fastening and connecting pipes, tubes and hoses for mobile and industrial hydraulic applications and many other industries.

The portfolio is completed by components for shutting-off, regulating, throttling and measuring fluid media.

In order to perfectly match each other, STAUFF Line products are designed and offered on a high, uniform level of quality. A large proportion of the range made from steel comes as standard with the premium STAUFF Zinc/Nickel surface coating, which is also optionally available for many of the other components.

This coating offers the most reliable surface protection far beyond the previous market standards – even after transport, handling and assembly of the components – and meets all current legal requirements.

If desired, Original Equipment Manufacturers can be supported with value-added services, from **technical consultation to pre-assembly, assembly and kitting** as well as **logistics services**:

- Support with the **selection of suitable standard components** and ordering options; provision of **customised solutions** according to customer's specifications or based on our in-house development – from prototyping to large scale production
- **Analysis and optimization** of existing and design and developments of new systems aimed at increasing the efficiency and performance of machines and equipment and creating value for customers by reducing the total cost
- **Pre-assembly, assembly and kitting** of individual components to customer-specific system modules
- Individually coordinated **procurement solutions** (e.g. web shop and electronic data interchange) and **supply models** (e.g. from warehousing of customised components to Kanban logistics and just-in-time delivery of pre-fabricated system modules to the assembly lines of the customers) aimed at optimising material flows



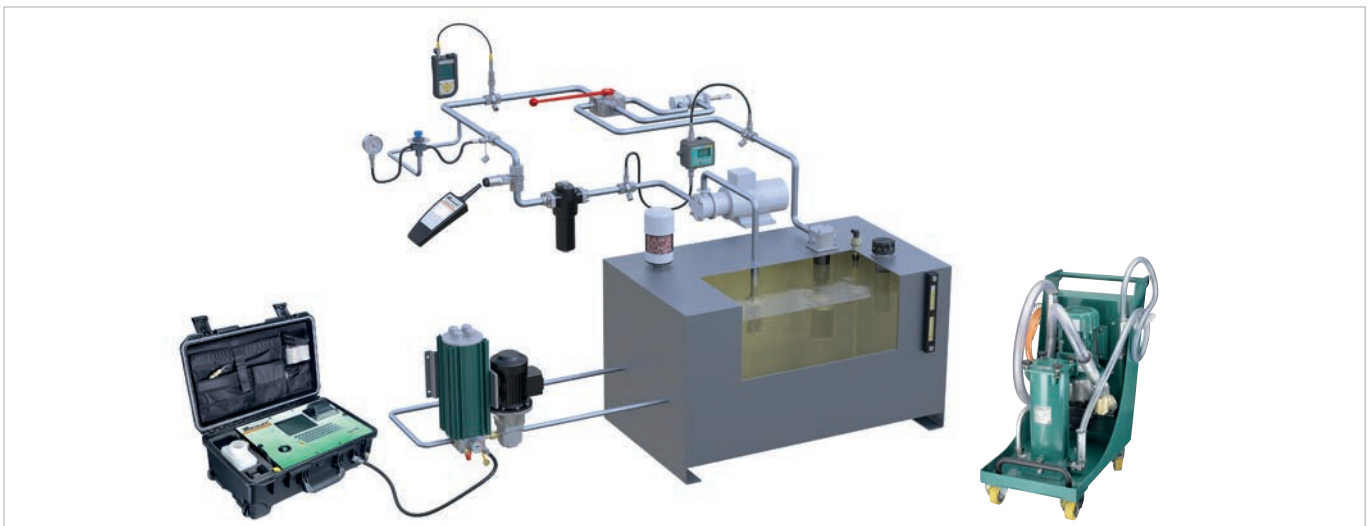

Aligned with the needs of the market, the product groups

- **STAUFF Test**
- **STAUFF Diagtronics**
- **STAUFF Filtration Technology**
- **STAUFF Hydraulic Accessories**

include a comprehensive range of analogue and digital measuring equipment and devices, filtration systems and replacement filter elements as well as accessories for the construction of tanks, reservoirs, power packs and gear boxes in mobile and industrial hydraulics.

The offer is completed by relevant value-added services:

- Support with the **selection of suitable components** and ordering options; provision of **customised solutions** according to customer's specifications or based on our in-house development – from prototyping to large scale production
- Analysis of existing hydraulic circuits aimed at filtration systems, tank components and monitoring devices that perfectly match to the specific requirements, and developing integrated concepts to increase the efficiency and performance of machines and equipment
- Individually coordinated **procurement solutions** and **supply models**



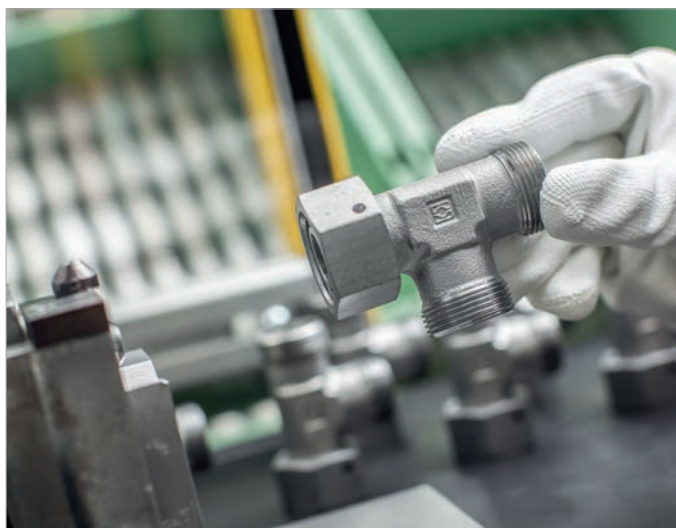

## STAUFF Connect

The STAUFF Connect product group is closely aligned with the market requirements and contains an extensive range of tube connectors made of carbon steel for metric tubes with outer diameters ranging from 4 to 42 mm in accordance with ISO 8434-1 / DIN 2353:

- 24° cutting ring fittings
- 24° taper fittings with O-ring
- 24° weld cones with O-ring
- 37° flared tube fittings

The product range is completed by check and alternating valves for inline installation, thread reducers as well as blanking plugs and screws.

Special product types and sizes as well as alternative materials, material combinations and surface coatings deviating from the standards can be supplied on request.

Automated assembly machinery and hardened, wear-resistant tools enable the reliable assembly of tube connectors – both for series production in the workshop and on-site.

Because of its versatility and flexibility, the patented STAUFF Form Tube Forming System is undoubtedly the best solution for series production, in particular for applications with highest requirements with regards to safety, reliability and repeatability as well as process stability.

For the finishing of the tube connector range in carbon steel, STAUFF relies on the STAUFF Zinc/Nickel surface coating which has proven successful for many years. It provides reliable surface protection – even after transport, handling and assembly – and meets all current legal requirements.

For selected types and series, independent certificates and approvals can be provided:

- Bureau Veritas
- DNV GL
- DVGW
- Lloyd's Register





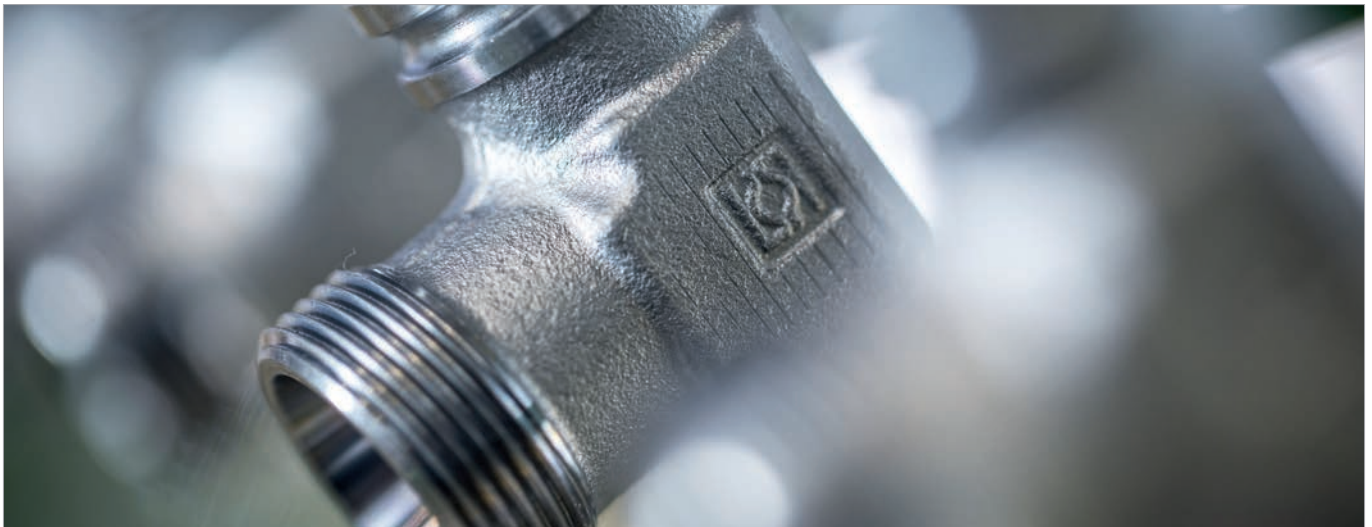

## STAUFF Zinc/Nickel Coating



### Layers

- Sealing
- Passivation
- Zinc/Nickel
- Steel

With at least 1200 hours resistance against red rust, the STAUFF Zinc/Nickel surface coating offers excellent surface protection – even after transport, handling and assembly. This was confirmed by testing in the salt-spray chamber according to DIN EN ISO 9227.

Users across all industries and applications benefit from sophisticated technology, which has been developed for and used by the very demanding automotive industry for many years now and that is already the proven standard for a large proportion of STAUFF components since 2007.

- At least 1200 hours resistance to red rust / base metal corrosion under practical conditions in the salt-spray chamber according to DIN EN ISO 9227
- White rust occurs only by way of a slight grey haze
- Surpassing the requirements of the corrosion protection class K5 as defined by the VDMA, the German Engineering Association (360 hours resistance to white rust / 720 hours resistance to red rust)
- Free of hexavalent chrome Cr(VI)
- ELV compliant according to 2000/53/EC (End of Life Vehicles Directive)
- REACH compliant according to 1907/2006/EC (Registration, Evaluation, Authorisation and Restriction of Chemicals)
- RoHS compliant according to 2002/95/EC (Restrictions of the Use of Hazardous Substances)
- Appealing colour scheme with a bright semi-gloss surface finish – comparable to Stainless Steel
- Significantly reduced tendency to corrosion by contact with other metals (such as Aluminium and Stainless Steel)
- Improved abrasion resistance due to the ductility / plastic deformability of the coating
- Little to no risk of triggering allergies – nickel release is down to only a fraction of the statutory limits relating to objects which come into direct and prolonged contact with the skin (independent results of the reference test method according to DIN EN 1811 are available on request)
- Good paint adhesion properties
- Resistance against all commonly used hydraulic media





## [www.stauff.com/catalogues](http://www.stauff.com/catalogues)

The STAUFF online catalogue centre at [www.stauff.com/catalogues](http://www.stauff.com/catalogues) provides fast and direct access to digital versions of this as well as other STAUFF product catalogues in all available languages.

### Online Page-Flip Catalogues

- Easy navigation through index or the powerful full text search functionality
- Contents can be shared and forwarded by e-mail, printed or downloaded and saved in PDF file format
- Also suitable for mobile devices

### Download Catalogues

- Download entire product catalogues and save them in PDF file format

### Catalogue Request

- Contact form to request printed copies of the product catalogue as well as digital copies on USB stick

The fastest way to the online page-flip catalogue:

The links that can be found at the bottom edge of all pages of this product catalogue will lead you directly to the corresponding page in the online page-flip catalogue.

In doing so, contents can be searched, shared and forwarded by e-mail, printed or downloaded and saved in PDF file format.

Scan the QR code next to the direct link with the camera of your mobile device\* and also use the functions in this way.

\* may require a suitable app





**www.stauff.com**

With the STAUFF Digital Platform available at [www.stauff.com](http://www.stauff.com), commercial customers and users of STAUFF products can not only inform themselves in all detail about the 50000 components typically available from stock, but also directly purchase these online without complex registration.

General information about the companies of STAUFF Group, latest business and product news as well as complete global contact details also be available.



**www.stauff.com/cad**

Immediate access to and free download of 3D models and 2D drawings for a growing number of STAUFF products





**www.filterinterchange.com**

Online database for the quick and easy identification and interchange of almost all common brands and types of replacement filter elements

**Main Functionalities of the STAUFF Digital Platform:**

-  **Around the clock**  
Check stock availability and pricing for STAUFF products in real time
-  **Cross references**  
Search by article designations of other manufacturers / suppliers
-  **Live chat**  
Get directly in touch with the STAUFF customer service and sales team
-  **CAD database**  
Download 3D models and 2D drawings for STAUFF products

**Advantages as a Registered User of the STAUFF Digital Platform:**

-  **Purchase STAUFF products**  
Taking customer-specific pricing and delivery conditions into account
-  **Ordering w/o searching**  
Quick ordering by entering article number, quantity and requested delivery date
-  **File upload**  
Direct upload of orders with multiple positions in CSV or Excel file format
-  **Notepad function**  
Create project lists to save interesting products for later

Follow STAUFF and keep yourself updated:

 **LinkedIn**  
[www.linkedin.com/company/stauff](http://www.linkedin.com/company/stauff)

 **Youtube**  
[www.youtube.com/stauffgroup](http://www.youtube.com/stauffgroup)

 **STAUFF Newsletters**  
Automatic e-mail notifications about latest news from STAUFF  
[www.stauff.com/newsletter](http://www.stauff.com/newsletter)





24° Tube Fittings in General	14
24° Tube Fittings with Single / Double Edge Cutting Ring	16
24° Tube Fittings with Soft-Sealing Cutting Ring	17
Tube Fittings with 24° Taper / O-Ring (DK0)	18
24° Weld Cones with O-Ring	19
24° Tube Fittings using the STAUFF Form EVO Tube Forming System	20
37° Flared Tube Fittings	22
Overview of 24°- Tube Fittings (ISO 8434-1 / DIN 2353)	24



## 24° Tube Fittings in General

A

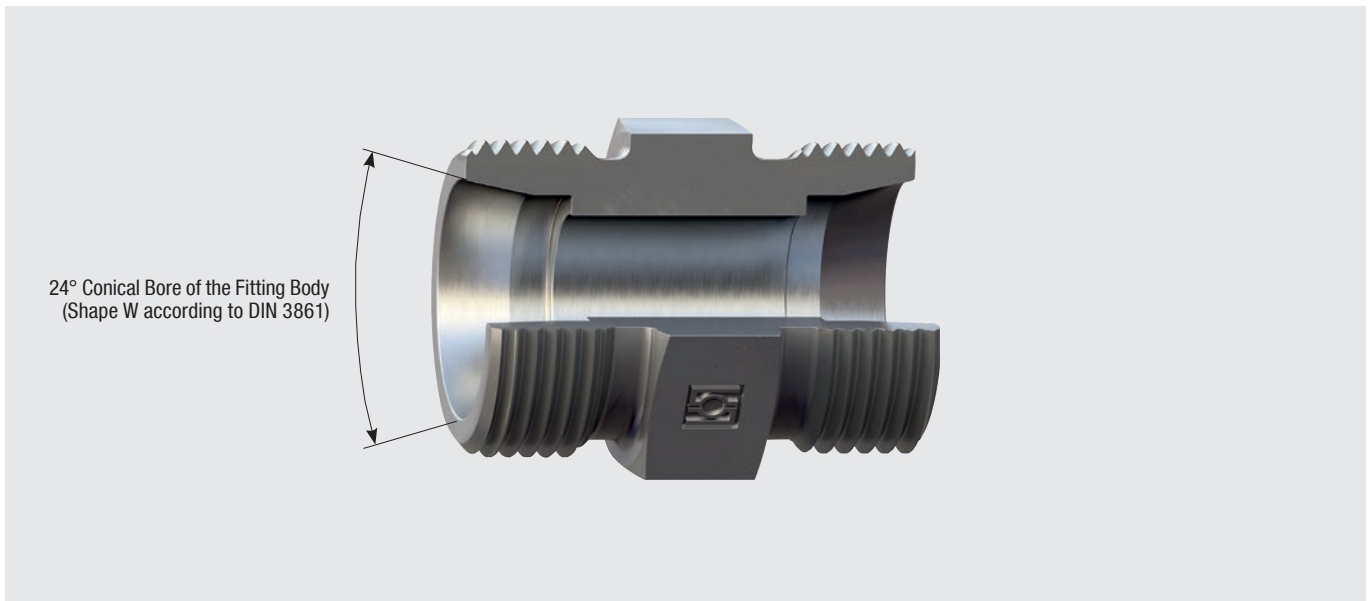

24° Tube Fittings are surely among the most commonly used and established industrial tube connector systems worldwide. They are regarded as the universal standard for fluid power applications in markets that use the metric system, such as Europe, Asia, Africa and South America.

Even in regions that traditionally used or still use the imperial measurement system (such as Australia or Northern America) 24° tube fittings are gaining more and more acceptance due to the ongoing metrification and specifications by globally operating OEMs.

24° Tube Fittings are specified in the ISO 8434-1 and DIN 2353 standards.

At least one tube connection end of the fitting body is characterized by a 24° conical bore (shape W according to DIN 3861), which serves as a metallic sealing surface, while the other end of the body is available with a variety of different connection types, such as male and female threaded or weld studs.

Various shapes (e.g. straight fittings, elbows, tees, crosses etc.) and designs (e.g. unions, studs, bulkheads or adjustable fittings) are available.

The portfolio consists of the Extra-Light (LL) Series as defined in the DIN 2353 standard as well as the Light Series (L) and the Heavy Series (S) as defined in the ISO 8434-1 standard, which differ from each other in particular with regards to their dimensions and pressure ratings.

### Main Advantages of the 24° Tube Fitting System

- 24° Tube Fittings can be quickly and easily field-assembled and even re-assembled with just a couple of standard wrenches and no requirement for hours of expensive staff training or special tube treatment. Under regular conditions, subsequent re-tightening of 24° Tube Fittings is not necessary.
- Most types of 24° Tube Fittings are available and suitable for light, medium, heavy and extra-heavy wall tubing with outside diameters ranging from 4 to 42 mm / .16 to 1.65 in, which allows optimum dimensioning of pipework circuits and saves material cost.
- The 24° Tube Fitting System is available in the Extra-Light (LL), the Light (L) and the Heavy (S) Series and provides suitable components with regards to sufficient pressure ratings and maximum leak-tightness up to nominal pressures of 800 bar / 11600 PSI (depending on series, type and size of the component – pressure reduction factors to be considered) for literally each application.
- Thanks to their optimised inner contour and design, 24° Tube Fittings offer ideal flow rates and therefore guarantee best performance without the excessive generation of vibrations, noise or heat.
- 24° Tube Fittings are small and compact in design compared to other systems, which makes them perfect for applications with space considerations.
- The recommended material raise in front of the first edge of the cutting ring after the assembly is clearly visible to tube fitters and inspectors and makes it easy to check and confirm the correct assembly of 24° Tube Fittings.
- On-site piping with 24° Tube Fittings is very efficient and offers maximum flexibility for tube fitters as the exact required tube length can be easily checked in advance by just trying out.
- 24° Tube Fittings are easy to combine with other tube fitting systems – even hoses can be connected without difficulties.



Overview of 24° Tube Fittings

A

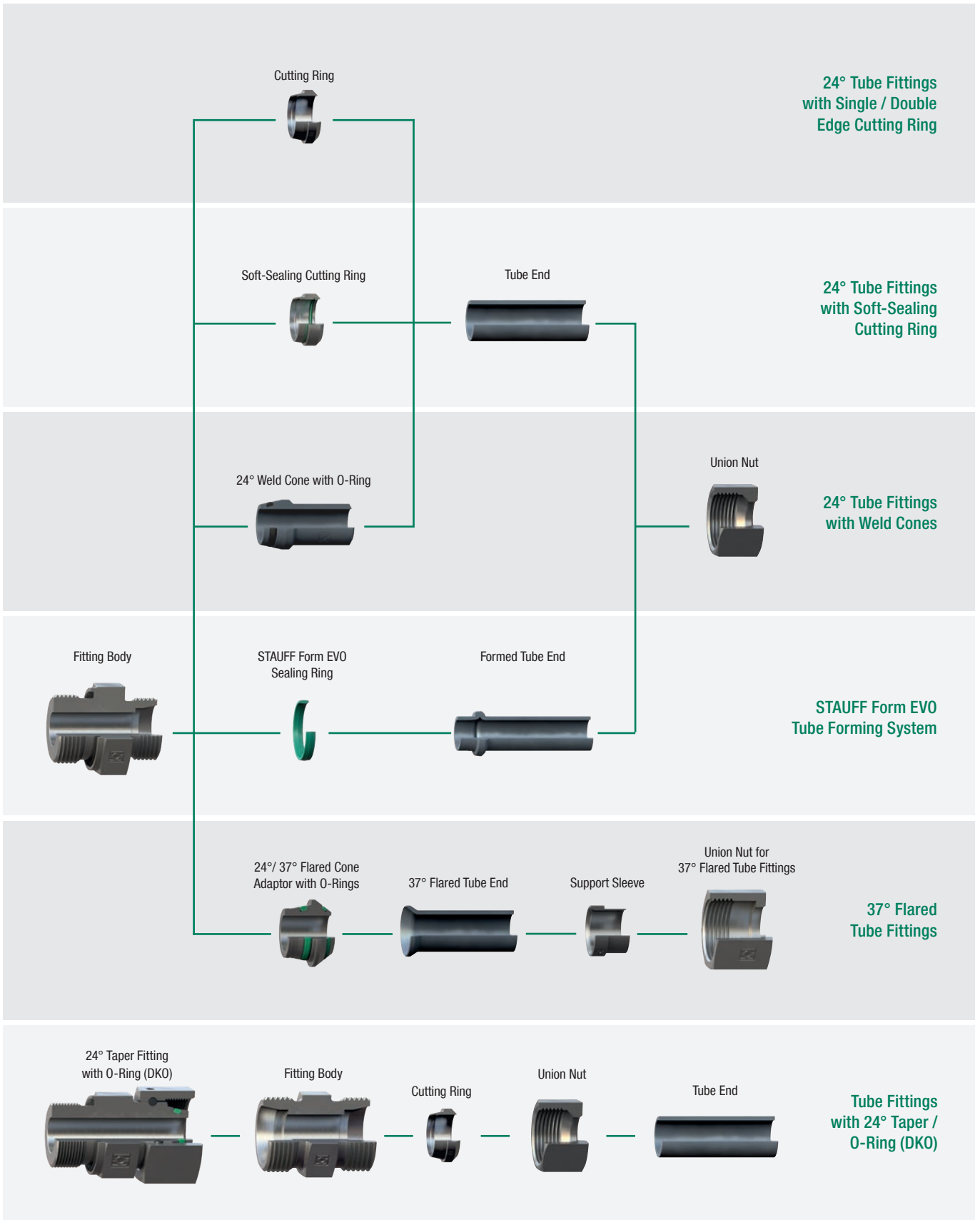

## 24° Tube Fittings with Single / Double Edge Cutting Ring

A

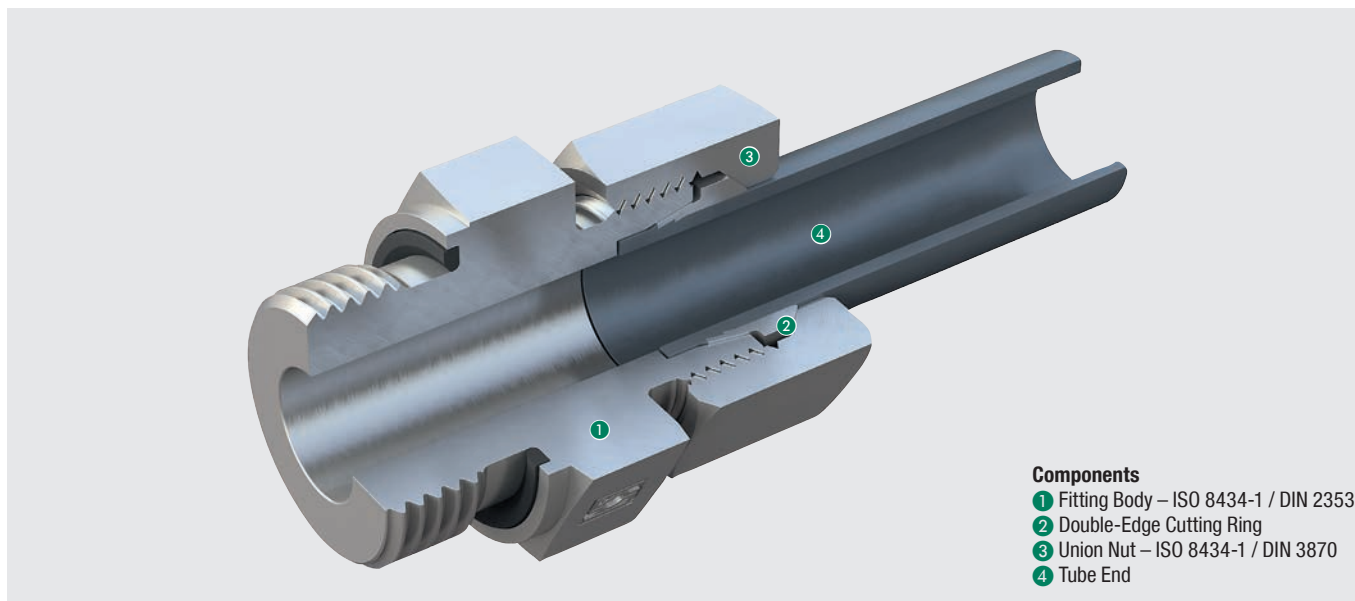

- Components**
- 1 Fitting Body – ISO 8434-1 / DIN 2353
  - 2 Double-Edge Cutting Ring
  - 3 Union Nut – ISO 8434-1 / DIN 3870
  - 4 Tube End

STAUFF Connect 24° Tube Fittings with Cutting Ring have been developed and designed for the reliable, leak-free connection of metric tubes with outside diameters between 4 mm and 42 mm / between .16 in and 1.65 in respectively.

Therefore, the most relevant key dimensions of the tube fittings (e.g. through bores and widths across flats) also have metric dimensions.

With regards to their dimensioning and general design, STAUFF Connect 24° Tube Fittings with Cutting Ring fully comply with the latest versions of the ISO 8434-1 and the DIN 2353 standards.

The operating principle of STAUFF Connect 24° Tube Fittings with Cutting Ring is based on a double-edge cutting ring, which cuts into the tube twice, thus ensuring the necessary force and form closure in the cutting area.

Thanks to the optimised geometry of this ring, the two edges do not cut simultaneously, but rather one after the other. In addition to increasing the incising effect, this method maximises the tear strength of the fitting.

Due to the design of the double-edge cutting ring in the central region as well as in the shoulder area, a larger tube support surface with a high surface pressure is achieved without jamming the cutting ring. This ensures uniform distribution of force. The outer support surfaces of the cutting ring are smoothed, thus minimising friction losses during assembly and guaranteeing the maximum degree of safety during use.

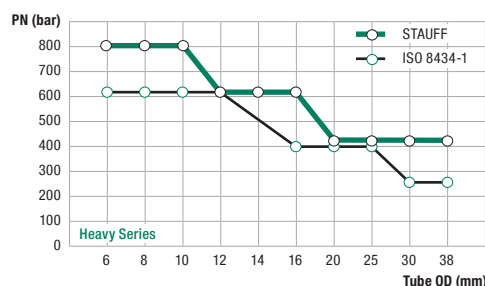
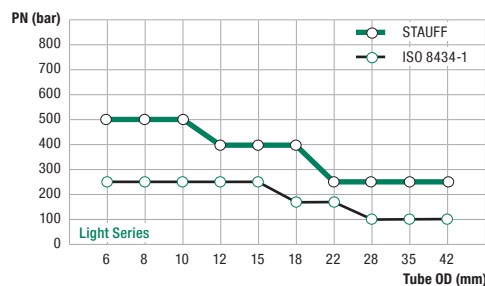

Nominal pressure levels of tube fittings

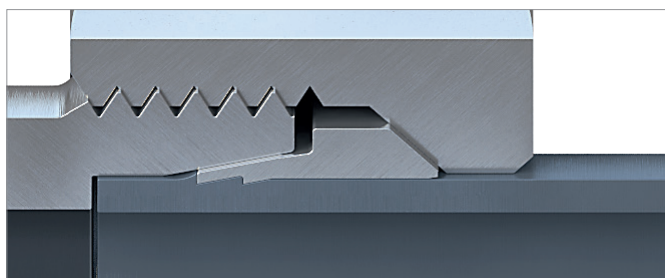

STAUFF Connect 24° Tube Fittings with Cutting Ring even exceed the ISO requirements in pressure: They can be used in applications with nominal pressures up to 500 bar / 7250 PSI in the Light Series and up to 800 bar / 11600 PSI in the Heavy Series (depending on series, type and size of the components – pressure reduction factors to be considered).

For dimensional reasons, STAUFF Connect 24° Tube Fittings with Cutting Ring in the Extra-Light Series use single-edge cutting rings (suitable for nominal pressures up to 100 bar / 1450 PSI)

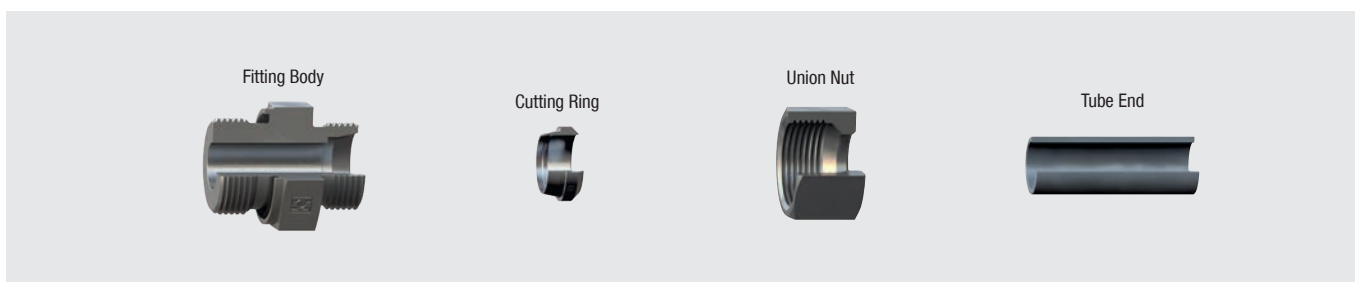



## 24° Tube Fittings with Soft-Sealing Cutting Ring

A

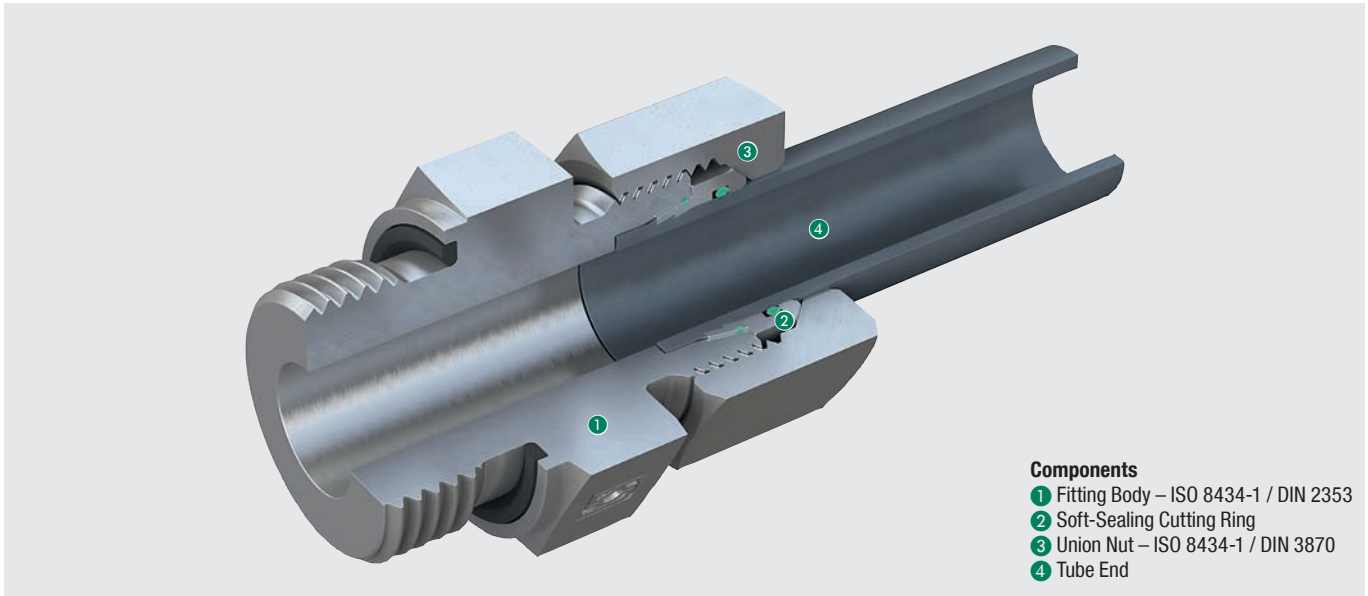

Soft-Sealing Cutting Rings provide an additional safety and protection against potential leakage risks, e.g. caused by the settling of purely metallic sealed connections, temperature fluctuations or considerable pressure and vibration loads in the system. "Sweating effects" on the connection points can be permanently avoided.

The type FI-WDDS Soft-Sealing Cutting Ring of the STAUFF Connect range is characterised by the elastomer sealing, which is located in a specially designed groove close to the rear end of the 24° taper and protected to prevent loss. An additional o-ring is used to secure the second potential leakage path between the cutting ring and the tube – even in the event of unfavourable tolerances

FKM (Viton®) is used as the standard sealing material and enables problem-free use of the system for challenging applications involving high temperatures or aggressive media.

Like all other components in the STAUFF Connect product range, the cutting ring itself is designed as standard with a high-quality zinc/nickel surface coating. With over 1,200 hours of resistance to red rust / base metal corrosion in the salt-spray chamber in accordance with DIN EN ISO 9227, the coating offers most reliable corrosion protection far beyond previously accepted market standards. Even after shipping, handling and assembly of the components, the coating significantly exceeds the requirements for the highest corrosion protection class K5 defined in VDMA Standard Sheet 24576 for tube connectors.

Alternative materials and surface and surface finishings are available on request.

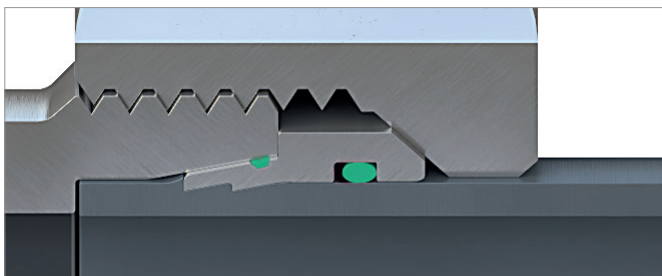

Both elastomer sealings are located in the secondary sealing zone of the connection. Static and dynamic loads in the system are primarily compensated by the tried and tested metallic sealed area. When assembled, the soft-sealing elements are almost completely chamfered (as gap-free and cavity-free as technically possible). This prevents extrusion of the sealings and contributes to the excellent longterm stability of the system.

Type FI-WDDS Soft-Sealing Cutting Rings convince through their simple assembly in the fitting body: Use a suitable spanner to tighten the union nut until the point where the cutting ring comes into contact and sits closely with the face side of the fitting body. This point is characterised by a significant increase in force.

Due to the design, the risks of insufficient assembly as well as over-assembly of cutting rings (which can lead to damage or radial constriction of thin-walled tubes) can be significantly reduced.

As a matter of course, the recommended material raise in front of the first edge of the cutting ring after the completed assembly is clearly visible to tube fitters and inspectors and makes it easy to check and confirm the correct assembly – as required by the norm.

Type FI-WDDS Soft-Sealing Cutting Ring are available for all metric tubes with outside diameters between 6 mm and 42 mm / between .24 in and 1.65 in respectively. They even exceed the ISO requirements in pressure and can be used in applications with nominal pressures up to 500 bar / 7250 PSI in the Light Series and up to 800 bar / 11600 PSI in the Heavy Series (depending on series, type and size of the components – pressure reduction factors to be considered).

Users benefit from the great versatility and flexibility of the system, as well as the many combination and adaptation options offered by using standard components from the STAUFF Connect product range (in accordance with the latest versions of the ISO 8434-1 and the DIN 2353 standards). There is therefore no need to duplicate the stock-keeping of similar components with a correspondingly high likelihood of confusion, as is often the case with comparable systems. Material and logistics costs can thus be correspondingly reduced.

Connections using regular, purely metallic sealing double-edge cutting rings can be interchanged without any problems.

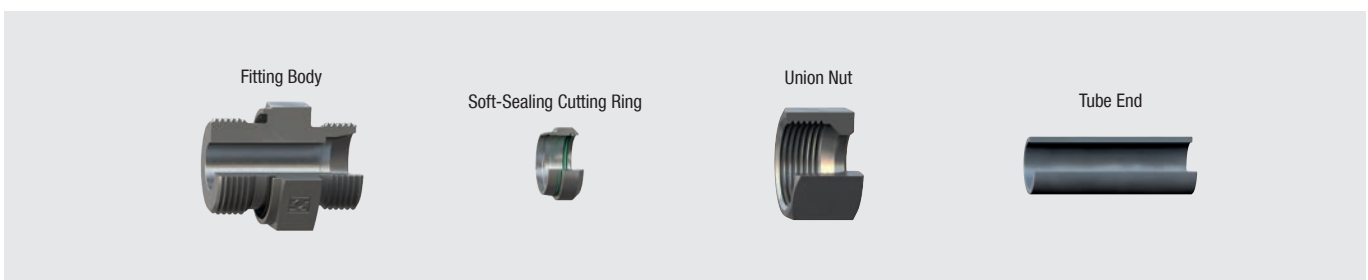

## Tube Fittings with 24° Taper / O-Ring (DKO)

A

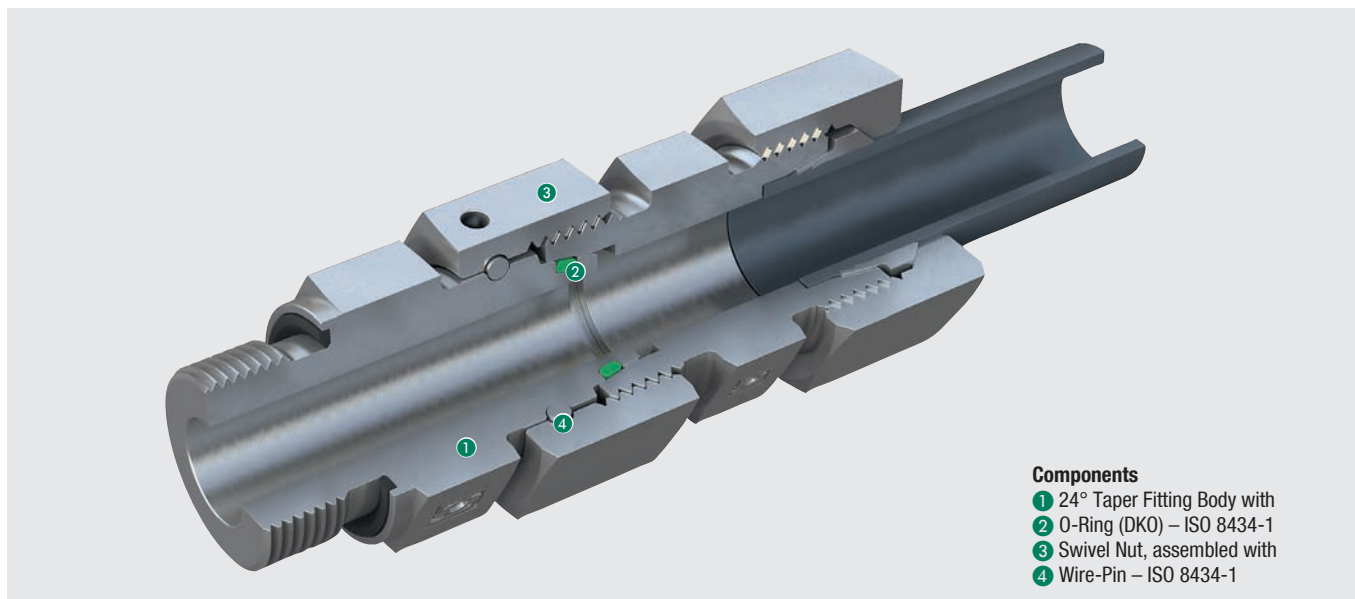

Due to the 24° taper (with o-rings) located on the fitting body itself, STAUFF Connect Tube Fittings with 24° Taper / O-Ring (DKO) represent a logical further development of traditionally available adjustable standpipe tube fittings with factory-assembled cutting rings and union nuts.

The retention function is assured by a special swivel nut with a wire-pin located in a groove, which is factory-assembled by the manufacturer.

The embedded o-ring on the 24° taper ensures a high level of protection against leakage.

Thanks to the large number of available types and designs, almost all common types and combinations of adjustable fittings can be implemented.

With regards to their dimensioning and general design, STAUFF Connect Tube Fittings with 24° Taper / O-Ring (DKO) fully comply with the latest versions of the ISO 8434-1 standard. They are thus completely interchangeable with conventional adjustable standpipe tube fittings.

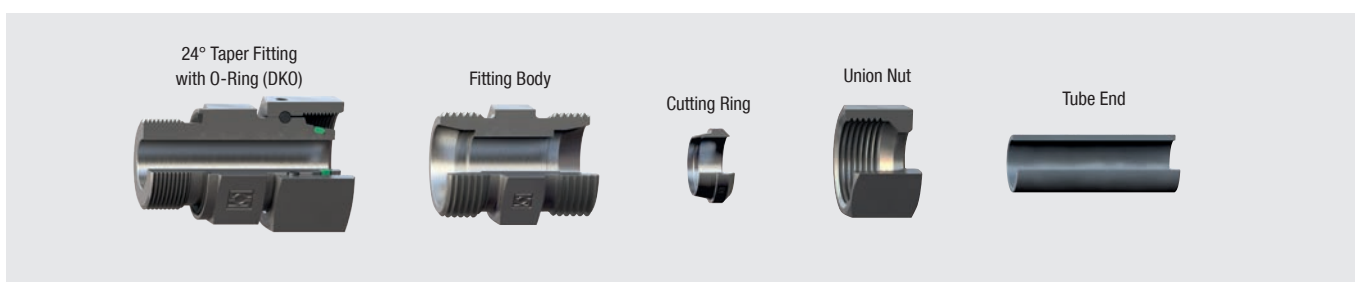

## 24° Weld Cones with O-Ring

A

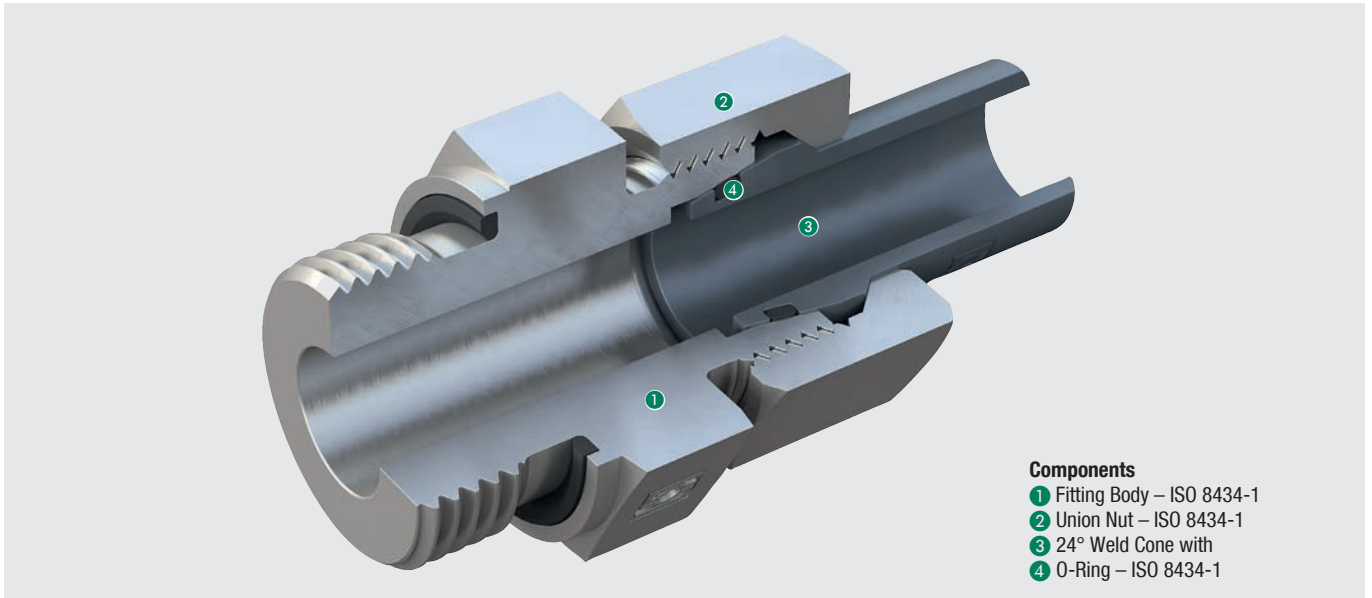

**Components**

- ① Fitting Body – ISO 8434-1
- ② Union Nut – ISO 8434-1
- ③ 24° Weld Cone with
- ④ O-Ring – ISO 8434-1

STAUFF Connect 24° Weld Cones with O-Ring represent a supplement to the usual range of tube fittings. However, they are increasingly perceived as a special solution due to the complex tube preparation, assembly, finishing and testing, as are all other types of welded connectors.

STAUFF Connect 24° Weld Cones with O-Ring are directly welded to the tube end.

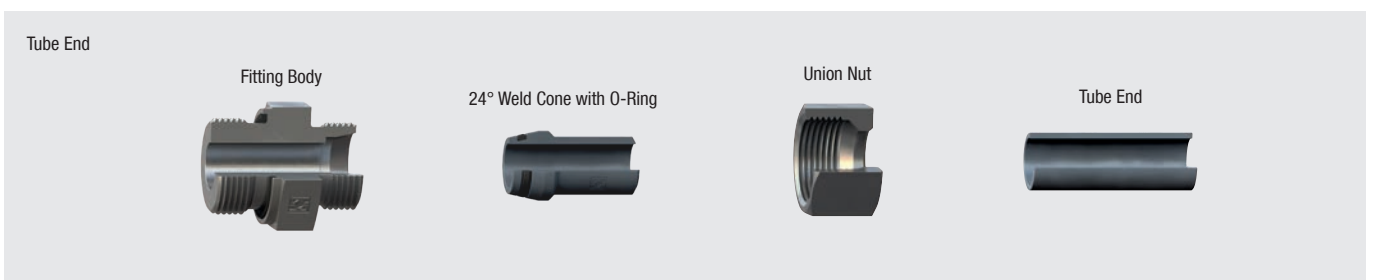
With regards to their dimensioning and general design, they fully comply with the latest versions of the ISO 8434-1 standard.



## 24° Tube Fittings using the STAUFF Form EVO Tube Forming System

A

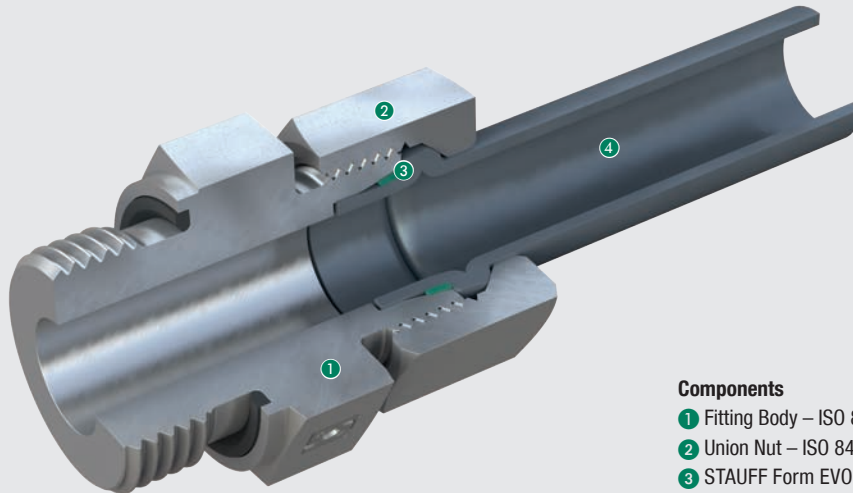

### Components

- ① Fitting Body – ISO 8434-1
- ② Union Nut – ISO 8434-1
- ③ STAUFF Form EVO Sealing Ring
- ④ Formed Tube End

### Performance

The STAUFF Form tube forming system was first presented in 2015. Since the beginning it has undoubtedly been one of the most efficient solutions available on the market for connecting metric tubes. In addition to its simplicity, it convinces with a high degree of safety, reliability and reproducibility.

With STAUFF Form EVO, STAUFF now presents the latest generation of the tube forming system, which is characterised by an increased level of efficiency and versatility as a result of continuous optimisation.

STAUFF Form EVO has been designed as standard for seamless cold-drawn precision steel tubes as well as stainless steel tubes with dimensions between 6 x 1.5 mm and 42 x 4 mm in the Light Series and between 6 x 1.5 mm and 38 x 6 mm in the Heavy Series. If required, parameters for alternative materials are available upon request and can be added by the manufacturer or via the optional cloud connection module integrated in the machines.

### System Design and Components

The system is based on standard parts and consists of only four key components:

The STAUFF Form EVO Sealing Ring is slid onto the tube end, which has previously been mechanically contoured. This creates a positive-locking connection that provides a reliable, permanent and maintenance-free seal when used with a conventional fitting body with 24° conical bore and a union nut, both according to ISO 8434-1.

### Versatility and Flexibility

Users benefit from the great versatility and flexibility of the system, as well as the many combination and adaptation options offered by using standard components from the STAUFF Connect product range.

There is therefore no need to duplicate the stock-keeping of similar components with a correspondingly high likelihood of confusion, as is often the case with comparable systems. Material and logistics costs can thus be correspondingly reduced.

### Materials and Surface Finishing

All components in the STAUFF Connect product range are designed as standard with a high-quality zinc/nickel surface coating.

With over 1,200 hours of resistance to red rust / base metal corrosion in the salt-spray chamber in accordance with DIN EN ISO 9227, the coating offers most reliable corrosion protection far beyond previously accepted market standards.

Even after shipping, handling and assembly of the components, the coating significantly exceeds the requirements for the highest corrosion protection class K5 defined in VDMA Standard Sheet 24576 for tube connectors.

### Sealing

The sealing of the only possible leakage path is provided primarily by the large-volume elastomeric sealing of the STAUFF Form EVO Sealing Ring which is specifically positioned between the surface of the tube and the 24° conical bore of the fitting body during assembly.

FKM (Viton®) is used as the standard sealing material and enables problem-free use of the STAUFF Form EVO tube forming system for challenging applications involving high temperatures or aggressive media.

Thanks to the combined metal-elastomer sealing, the usage of the system in low-temperature ranges down to -35° C is possible without restriction – as is also the case with NBR (Buna-N®).

The unique sealing profile has a particularly large cross-section in order to seal securely and permanently, even in the event of unfavourable tolerances of the tube or the tube fitting. Possible errors during assembly on the formed tube end are consistently avoided by the laterally equal profile of the sealing ring. The sealing effect is supported by the system pressure of the hydraulic system, so that the STAUFF Form EVO tube forming system is perfectly suited for high-pressure applications.

Fitting Body



STAUFF Form EVO Sealing Ring



Formed Tube End



Union Nut

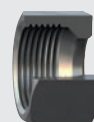

## Design

- Based on standard components including the standard union nut of the STAUFF Connect product range according to ISO 8434-1 – No duplicate storage of similar stocking of similar components with a correspondingly high risk of confusion
- Positive-locking connection with an elastomer sealing with a particularly large cross-section to provide secure and permanent sealing even in the event of unfavourable tolerances
- Sealing of the only possible leakage path primarily via the STAUFF Form EVO sealing ring as well as the secondary, face sealing
- Preservation of the flow behaviour through the optimised shape of the formed tube end

## Assembly Tools and Devices

- Robust table-top device for continuous operation in the workshop
- High efficiency of the system with low cycle times
- Optimum tool concept with exchangeable internal tube supports, so that only a small number of tools is required to cover all tube diameters
- Intuitive operation via touchscreen
- Optional cloud connection as well as machine briefings and trainings
- All tools needed for the forming process clearly labelled with the tube dimensions so that assembly errors caused by incorrect assignment can be largely ruled out
- Short times required for tool changes as clamping jaws, tube shaper and internal tube supports can be simply replaced without the need for any tools
- Attractive maintenance packages to ensure best possible service
- Low insertion depths compared to alternative systems for even more complex tube geometries and smaller bending radii

## Durability and Application

- Suitable for both steel and stainless steel tubing as standard – also applicable for alternative tube materials on request
- Covers all common metric tube dimensions from 6 x 1.5 mm to 42 x 4 mm in the Light Series and 38 x 6 mm in the Heavy Series respectively
- Suitable for nominal pressures up to 800 bar in the Heavy Series – designed with four-fold safety and maximum tear-out strength
- The use of FKM (Viton®) as the standard seal material makes the system perfect for the most challenging applications. Thanks to the combined metal-elastomer seal, low-temperature ranges down to -35° C are possible without restriction
- High-quality zinc/nickel surface coating provides maximum protection and corrosion resistance – standard for all parts in the STAUFF Connect range

## Final Assembly

- Incredibly simple final assembly in the fitting body with low assembly torques as well as short assembly paths (once the fixed point has been reached) with a minimised risk of over-assembly
- Assembly errors are consistently avoided due to the laterally identical profile of the sealing ring
- Connections can be untightened as often as required and reassembled without wear, as any damaging expansion of the 24° conical bore of the fitting body is technically avoided
- No need for time-consuming and expensive training

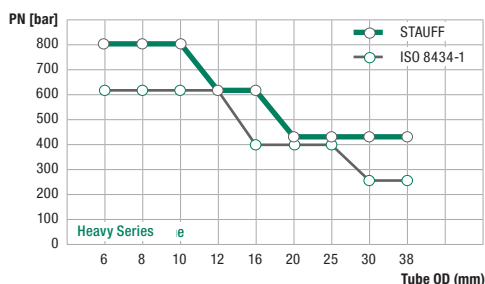
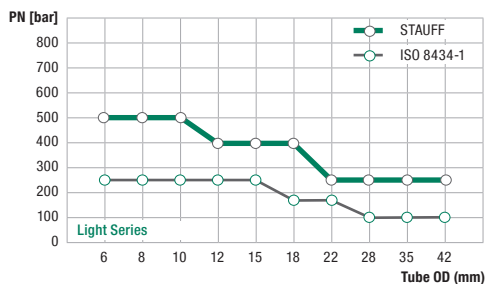

Nominal pressure levels of tube fittings

## Pressure Resistance

When the STAUFF Form EVO tube forming system is used in conjunction with genuine products from the STAUFF Connect product range, it provides pressure resistance of up to 800 bar / 11600 PSI in the Heavy Series and 500 bar / 7250 PSI in the Light Series (generally with a four-fold safety factor and depending on the series, design and size of the fitting body and taking into consideration various pressure reducing factors).

This is the result of exceptional care taken in the development of the system and the selection, handling and processing of the raw materials.

Maximum tear-out strength can be guaranteed for the system due to the contour shaped at the tube end.

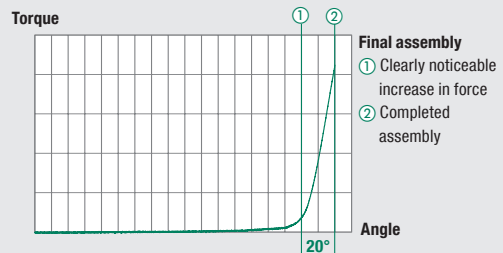

## Final Assembly in the Fitting Body

Final assembly is performed by tightening the union nut until the point with clearly noticeable increase in force (fixed point). The assembly is completed with another turn by approximately 15° to 20° beyond this point.

This incredibly simple assembly method has several benefits for the user:

- Considerably lower torques and short assembly paths (once the fixed point has been reached)
- Significant increase in torque to clearly indicate the end of the assembly
- Maximum safety to combat over-assembly
- No need for time-consuming and expensive training

Connections made with the STAUFF Form EVO can be untightened as often as required and reassembled without wear, as any damaging expansion of the 24° conical bore of the fitting body is technically avoided.



## 37° Flared Tube Fittings

A

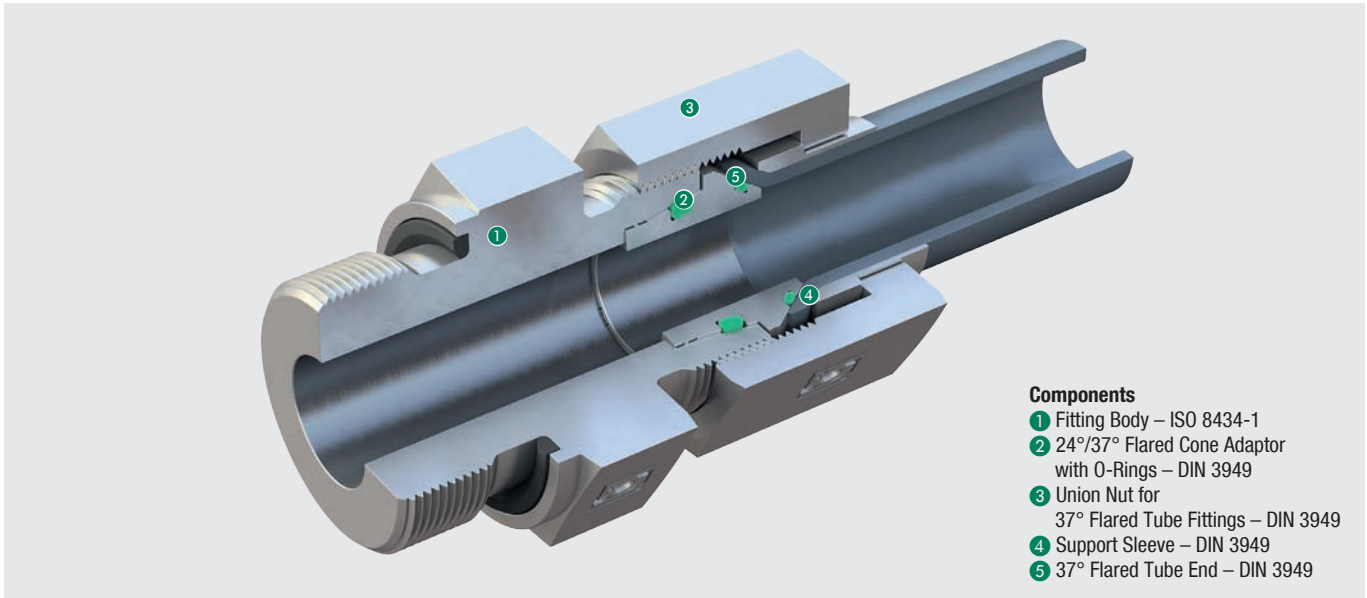

### Components

- ① Fitting Body – ISO 8434-1
- ② 24°/37° Flared Cone Adaptor with O-Rings – DIN 3949
- ③ Union Nut for 37° Flared Tube Fittings – DIN 3949
- ④ Support Sleeve – DIN 3949
- ⑤ 37° Flared Tube End – DIN 3949

STAUFF Connect 37° Flared Tube Fittings have been developed and designed for the reliable, leak-free connection of tubes with a 37° flare with conventional fitting bodies with a 24° cone according to ISO 8434-1.

Thanks to the optimised geometry of STAUFF Connect 37° Flared Tube Fittings with metallic/elastomer sealing at the contact points both to the fitting body and the tube, efficient sealing is ensured, even if there are vibrations and pressure fluctuations / peaks.



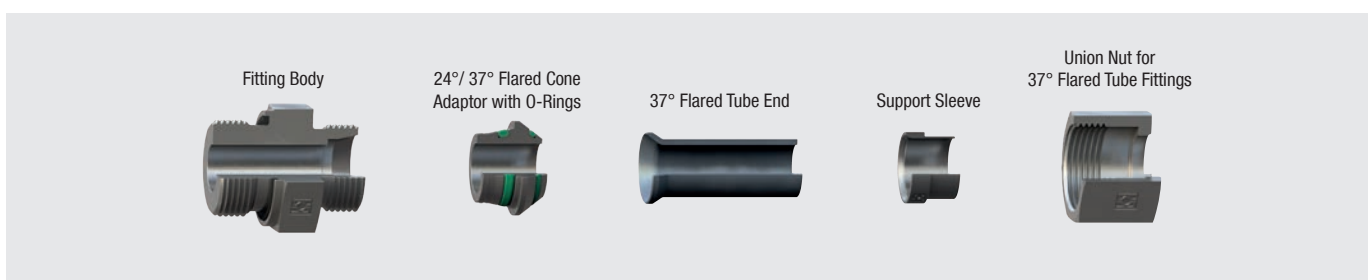

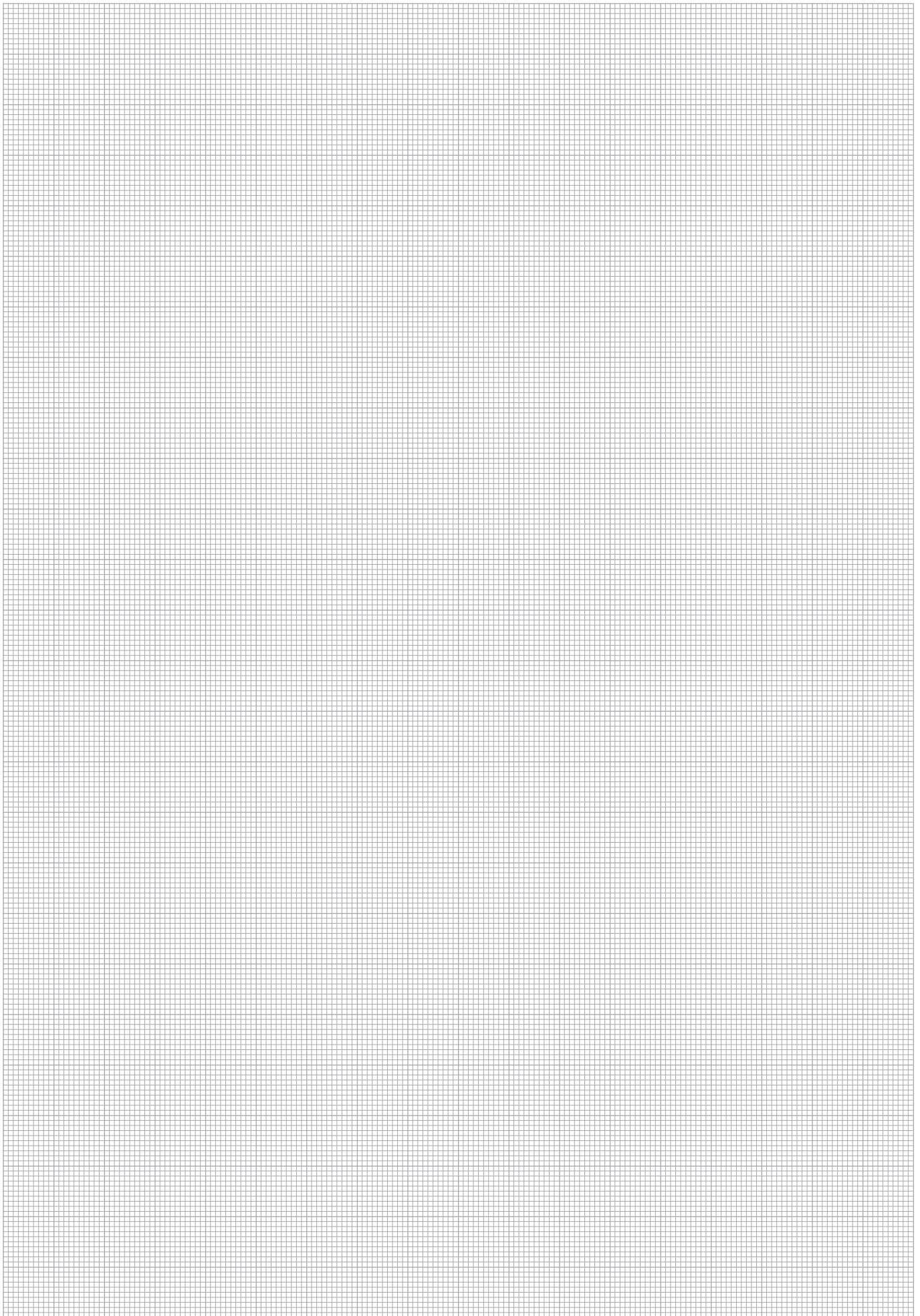











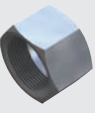



















STAUFF Connect 37° Flared Tube Fittings can be used in applications with nominal pressures up to 500 bar / 7250 PSI on the Light Series or up to 630 bar / 9135 PSI in the Heavy Series (pressure reduction factors to be considered).





Overview of 24°- Tube Fittings (ISO 8434-1 / DIN 2353)

A



































Connecting Parts	Double Edge Cutting Ring  Page 28 FI-DS	Soft-Sealing Cutting Ring  Page 29 FI-WDDS	Support Sleeve  Page 31 FI-VH	STAUFF Form EVO Sealing Ring  Page 32 FI-FD	Union Nut  Page 33 FI-M	24°/37° Flared Cone Adaptor with O-Rings  Page 34 FI-BA			
	Support Sleeve for 37° Flared Tube Fittings  Page 35 FI-BH	Union Nut for 37° Flared Tube Fittings  Page 36 FI-BM	37° Flared Tube Fitting Set  Page 37 FI-AB						
	Male Stud Fittings	Straight Male Stud Fitting  Page 40 FI-GE-	Male Stud Elbow  Page 74 FI-WE-	Male Stud Branch Tee  Page 82 FI-TE-	Male Stud Barrel Tee  Page 88 FI-LE-				
		Tube Fittings / Unions	Straight Union  Page 96 FI-G	Straight Reducer  Page 97 FI-G	Equal Elbow  Page 99 FI-W	Equal Tee  Page 100 FI-T	Tee Reducer  Page 101 FI-T	Equal Cross  Page 104 FI-K	
			Bulkhead Fittings	Straight Bulkhead Fitting  Page 108 FI-GS	Elbow Bulkhead Fittings  Page 109 FI-WS	Straight Bulkhead Weld Fitting  Page 110 FI-ES			
				Weld Fittings	Straight Weld Fitting  Page 114 FI-AS	Elbow Weld Fitting  Page 115 FI-WAS	24° Weld Cone with O-Ring  Page 116 FI-SN	24° Weld Cone Reducer with O-Ring  Page 118 FI-SNR	Straight Weld Fitting for Tubes  Page 120 FI-ASV
	Female Studs and Gauge Fittings				Straight Female Stud Fitting  Page 124 FI-GA-	Gauge Fitting  Page 129 FI-MA-	Gauge Fitting with 24° Taper / O-Ring  Page 130 FI-EMAD-	Gauge Standpipe Fitting  Page 131 FI-EMA-	
Fittings with 24° Taper / O-Ring (DKO)			Straight Male Stud Fitting  Page 134 FI-EGED		Straight Fitting / Reducer  Page 138 FI-SNV	Straight Reducer for Tube Ends  Page 144 FI-RESD	Distance Adaptor  Page 148 FI-RESD	Adjustable Elbow (90°)  Page 150 FI-EWD	Adjustable Elbow (45°)  Page 151 FI-EVD















Overview of 24°- Tube Fittings (ISO 8434-1 / DIN 2353)

A

Fittings with 24° Taper / O-Ring (DKO)	Adjustable Branch Tee  Page 152 FI-ETD	Adjustable Barrel Tee  Page 153 FI-ELD					
	Standpipe Fittings						
	Straight Male Stud Standpipe Fitting  Page 156 FI-EGE	Straight Standpipe Reducer  Page 162 FI-REDS	Adjustable Standpipe Elbow  Page 166 FI-EW	Adjustable Standpipe Branch Tee  Page 167 FI-ET	Adjustable Standpipe Barrel Tee  Page 168 FI-EL		
Fittings with Lock Nut	Adjustable Male Stud Elbow (90°)  Page 172 FI-WEE	Adjustable Male Stud Elbow (45°)  Page 173 FI-VEE	Adjustable Male Stud Branch Tee  Page 173 FI-TEE	Adjustable Male Stud Barrel Tee  Page 173 FI-LEE			
	Banjo Fittings						
	Banjo Elbow (Medium-Pressure Version)  Page 183 FI-RSWND	Banjo Elbow (High-Pressure Version)  Page 186 FI-RSW	Banjo Tee (High-Pressure Version)  Page 190 FI-RST				
	Swivel Fittings						
Swivel Elbow  Page 196 FI-DGWE							
Hydraulic Valves	Check Valve  Page 200-201 FI-RV / FI-RVA	Male Stud Check Valve (Flow from Stud End)  Page 202-205 FI-RVV / FI-RVVA	Male Stud Check Valve (Flow to Stud End)  Page 206-209 FI-RVZ / FI-RVZA	Female Stud Check Valve  Page 210-211 FI-RVI / FI-RVIA	Check Valve Installation Kit  Page 212 FI-VES	Alternating Valve  Page 213 FI-WV	
	Spare Parts / Accessories						
	Thread Reducer  Page 224 FI-RED	Blanking Screw for Ports (Heavy Duty)  Page 228 FI-VSV	Blanking Screw for Ports  Page 230 FI-VS	Blanking Plug with 24° Taper / O-Ring (DKO)  Page 234 FI-VD	Blanking Plug with Sealing Edge  Page 235 FI-BUZ	Blanking Plug for Tube Ends  Page 236 FI-VSK	
	Hexagon Lock Nut  Page 237 FI-SKM	Profile Sealing Ring  Page 238 WDG	O-Ring  Page 239 O-RING	External Metallic Sealing Ring  Page 244 FI-DKR	Retaining Ring with Captive Seal  Page 245 FI-DIR	Internal Metallic Sealing Ring  Page 246 FI-DKI	Retaining Ring (Small)  Page 247 FI-KR





	<b>Double Edge Cutting Ring</b> FI-DS	28
	<b>Soft-Sealing Cutting Ring</b> FI-WDDS	29
	<b>Soft-Sealing Cutting Ring (Stainless Steel)</b> FI-WDDS-W5	30
	<b>Support Sleeve</b> FI-VH	31
	<b>STAUFF Form EVO Sealing Ring</b> FI-FD	32
	<b>Union Nut</b> FI-M	33
	<b>24°/37° Flared Cone Adaptor with O-Rings</b> FI-BA	34
	<b>Support Sleeve for 37° Flared Tube Fittings</b> FI-BH	35
	<b>Union Nut for 37° Flared Tube Fittings</b> FI-BM	36
	<b>37° Flared Tube Fitting Set</b> FI-AB	37

**Cutting Ring**  
**Type FI-S (Single-Edge) ▪ Series LL**  
**Type FI-DS (Double-Edge) ▪ Series L / S**



B

**Ordering Codes**

**\*FI-DS\*-15\*L\*-W3**

\* Cutting Ring      Single-Edge Version      **FI-S**  
                                  Double-Edge Version      **FI-DS**

\* Outside Tube Diameter D1 (in mm)      **-15**

\* Series      Extra-Light Series      **LL**  
                                  Light Series      **L**  
                                  Heavy Series      **S**

\* Material Code      Steel, zinc/nickel-plated      **-W3**

Please contact STAUFF for alternative materials and surface finishings.

Series	Tube OD (mm/in) D1	PN (bar/psi)	Dimensions (mm/in)		Weight (kg/lbs) ca. per 100	Ordering Codes	
			L1			Double-Edge Cutting Ring	Single-Edge Cutting Ring
LL	4	100	6		0,04		FI-S-04LL-W3
	.16	1450	.24		.09		
	6	100	7		0,08		FI-S-06LL-W3
	.24	1450	.28		.18		
	8	100	7		0,1		FI-S-08LL-W3
	.31	1450	.28		.22		
	10	100	7		0,12		FI-S-10LL-W3
	.39	1450	.28		.26		
	12	100	7,5		0,15		FI-S-12LL-W3
	.47	1450	.30		.33		
L	6	500	9,5		0,21	FI-DS-06L/S-W3	
	.24	7250	.37		.46		
	8	500	9,5		0,26	FI-DS-08L/S-W3	
	.31	7250	.37		.57		
	10	500	10		0,34	FI-DS-10L/S-W3	
	.39	7250	.39		.75		
	12	400	10		0,44	FI-DS-12L/S-W3	
	.47	5800	.39		.97		
	15	400	10		0,54	FI-DS-15L-W3	
	.59	5800	.39		1.19		
	18	400	10		0,71	FI-DS-18L-W3	
	.71	5800	.39		1.56		
	22	250	11,5		1,01	FI-DS-22L-W3	
	.87	3625	.45		2.22		
	28	250	11,5		1,23	FI-DS-28L-W3	
	1.10	3625	.45		2.71		
	35	250	13,5		2,35	FI-DS-35L-W3	
	1.38	3625	.53		5.17		
42	250	13,5		2,69	FI-DS-42L-W3		
1.65	3625	.53		5.92			
S	6	800	9,5		0,21	FI-DS-06L/S-W3	
	.24	11600	.37		.46		
	8	800	9,5		0,26	FI-DS-08L/S-W3	
	.31	11600	.37		.57		
	10	800	10		0,34	FI-DS-10L/S-W3	
	.39	11600	.39		.75		
	12	630	10		0,44	FI-DS-12L/S-W3	
	.47	9135	.39		.97		
	14	630	10,5		0,63	FI-DS-14S-W3	
	.55	9135	.41		1.39		
	16	630	10,5		0,69	FI-DS-16S-W3	
	.63	9135	.41		1.52		
	20	420	12,5		1,26	FI-DS-20S-W3	
	.79	6091	.49		2.77		
	25	420	12,5		1,52	FI-DS-25S-W3	
	.98	6091	.49		3.34		
	30	420	13,5		2,06	FI-DS-30S-W3	
	1.18	6091	.53		4.53		
	38	420	13,5		2,54	FI-DS-38S-W3	
	1.50	6091	.53		5.59		

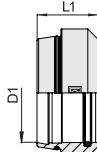

Soft-Sealing Cutting Ring  
 Type FI-WDDS • Series L / S

B

Series	Tube OD	PN	Dimensions		Weight ( <sup>kg</sup> / <sub>lbs</sub> ) ca. per 100	Ordering Codes Soft-Sealing Cutting Ring
	( <sup>mm</sup> / <sub>in</sub> ) D1	( <sup>bar</sup> / <sub>PSI</sub> )	( <sup>mm</sup> / <sub>in</sub> ) L1	( <sup>mm</sup> / <sub>in</sub> )		
L	6	500	8,8		0,19	FI-WDDS-06L/S-V-W3
	.24	7250	.35		.42	
	8	500	8,8		0,24	FI-WDDS-08L/S-V-W3
	.31	7250	.35		.53	
	10	500	9,8		0,35	FI-WDDS-10L/S-V-W3
	.39	7250	.39		.77	
	12	400	9,8		0,41	FI-WDDS-12L/S-V-W3
	.47	5800	.39		.90	
	15	400	10,2		0,66	FI-WDDS-15L-V-W3
	.59	5800	.40		1.44	
	18	400	10,2		0,82	FI-WDDS-18L-V-W3
	.71	5800	.40		1.79	
	22	250	11,5		1,06	FI-WDDS-22L-V-W3
	.87	3625	.45		2.34	
	28	250	11,5		1,28	FI-WDDS-28L-V-W3
	1.10	3625	.45		2.82	
	35	250	13,5		2,36	FI-WDDS-35L-V-W3
	1.38	3625	.53		5.18	
42	250	13,5		2,75	FI-WDDS-42L-V-W3	
1.65	3625	.53		6.05		
S	6	800	8,8		0,19	FI-WDDS-06L/S-V-W3
	.24	11600	.35		.42	
	8	800	8,8		0,24	FI-WDDS-08L/S-V-W3
	.31	11600	.35		.53	
	10	800	9,8		0,35	FI-WDDS-10L/S-V-W3
	.39	11600	.39		.77	
	12	630	9,8		0,41	FI-WDDS-12L/S-V-W3
	.47	9135	.39		.90	
	14	630	10,2		0,73	FI-WDDS-14S-V-W3
	.55	9135	.40		1.61	
	16	630	10,3		0,83	FI-WDDS-16S-V-W3
	.63	9135	.41		1.82	
	20	420	12,5		1,28	FI-WDDS-20S-V-W3
	.79	6091	.49		2.81	
	25	420	12,5		1,58	FI-WDDS-25S-V-W3
	.98	6091	.49		3.48	
	30	420	13,5		2,41	FI-WDDS-30S-V-W3
	1.18	6091	.53		5.31	
38	420	13,5		3,00	FI-WDDS-38S-V-W3	
1.50	6091	.53		6.60		

## Ordering Codes

**\*FI-WDDS\*-15\*L\*-V\*-W3**

* Soft-Sealing Cutting Ring		FI-WDDS
* Outside Tube Diameter D1 (in mm)		-15
* Series	Light Series	L
	Heavy Series	S
* Seal Material	FKM (Viton®)	-V
* Material Code	Steel, zinc/nickel-plated	-W3

Please contact STAUFF for alternative materials and surface finishings.

Standard seal material is FKM (Viton®).



**Soft-Sealing Cutting Ring (Stainless Steel)**  
**Type FI-WDDS-W5 ▪ Series L / S**

B

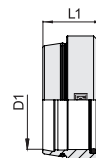

**Ordering Codes**

**\*FI-WDDS\*-15\*L\*-V\*-W5**

- \* Soft-Sealing Cutting Ring (Stainless Steel)      **FI-WDDS**
- \* Outside Tube Diameter D1 (in mm)                      **-15**
- \* Series                      Light Series                      **L**  
    Heavy Series                      **S**
- \* Seal Material              FKM (Viton®)                      **-V**
- \* Material Code              Stainless Steel V4A -  
    1.4571 (AISI 316 Ti)                      **-W5**

Please contact STAUFF for alternative materials and surface finishings.

Series	Tube OD		PN		Dimensions		Weight ( <sup>kg</sup> / <sub>lbs</sub> ) ca. per 100	Ordering Codes	
	(mm/in)	D1	(bar/psi)	(mm/in)	L1				
L	6	500	8,8				0,2	Soft-Sealing Cutting Ring (Stainless Steel)	
	.24	7250	.35				.44		
	8	500	8,8				0,25		FI-WDDS-08L/S-V-W5
	.31	7250	.35				.55		
	10	500	9,8				0,37		FI-WDDS-10L/S-V-W5
	.39	7250	.39				.81		
	12	400	9,8				0,44		FI-WDDS-12L/S-V-W5
	.47	5800	.39				.97		
	15	400	10,2				0,68		FI-WDDS-15L-V-W5
	.59	5800	.40				1.49		
	18	400	10,0				0,80		FI-WDDS-18L-V-W5
	.71	5800	.39				1.76		
	22	250	11,5				1,09		FI-WDDS-22L-V-W5
	.87	3625	.45				2.40		
	28	250	11,5				1,39		FI-WDDS-28L-V-W5
	1.10	3625	.45				3.06		
	35	250	13,5				2,47		FI-WDDS-35L-V-W5
	1.38	3625	.53				5.44		
	42	250	13,5				2,89		FI-WDDS-42L-V-W5
	1.65	3625	.53				6.37		
S	6	800	8,8				0,2	Soft-Sealing Cutting Ring (Stainless Steel)	
	.24	11600	.35				.44		
	8	800	8,8				0,25		FI-WDDS-08L/S-V-W5
	.31	11600	.35				.55		
	10	800	9,8				0,37		FI-WDDS-10L/S-V-W5
	.39	11600	.39				.81		
	12	630	9,8				0,44		FI-WDDS-12L/S-V-W5
	.47	9135	.39				.97		
	14	630	10,2				0,75		FI-WDDS-14S-V-W5
	.55	9135	.40				1.65		
	16	630	10,3				0,86		FI-WDDS-16S-V-W5
	.63	9135	.41				1.89		
	20	420	12,5				1,31		FI-WDDS-20S-V-W5
	.79	6091	.49				2.88		
	25	420	12,5				1,64		FI-WDDS-25S-V-W5
	.98	6091	.49				3.61		
	30	420	13,3				2,65		FI-WDDS-30S-V-W5
	1.18	6091	.52				5.84		
	38	420	13,5				3,20		FI-WDDS-38S-V-W5
	1.50	6091	.53				7.05		

Standard seal material is FKM (Viton®).

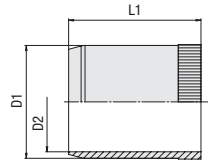

Support Sleeve  
Type FI-VH

B

Dimensions (mm/in)				Ordering Codes
for Tube	D1	D2	L1	
6 x 1	4	2,6	15,5	FI-VH-6x1-W69
.24 x .04	.16	.10	.61	
6 x 0,75	4,5	3,1	12,5	FI-VH-6x0.75-W69
.24 x .03	.18	.12	.49	
6 x 0,5	5	3,6	12,5	FI-VH-6x0.5-W69
.24 x .02	.20	.14	.49	
8 x 1	6	4,6	15,5	FI-VH-8x1-W69
.31 x .04	.24	.18	.61	
8 x 0,75	6,5	5,1	12,5	FI-VH-8x0.75-W69
.31 x .03	.26	.20	.49	
10 x 1,5	7	5,6	17	FI-VH-10x1.5-W69
.39 x .06	.28	.22	.67	
10 x 1	8	6,6	16,5	FI-VH-10x1-W69
.39 x .04	.31	.26	.65	
10 x 0,75	8,5	7,1	16,5	FI-VH-10x0.75-W69
.39 x .03	.33	.28	.65	
12 x 1,5	9	7,6	16,5	FI-VH-12x1.5-W69
.47 x .06	.35	.30	.65	
12 x 1	10	8,6	16,5	FI-VH-12x1-W69
.47 x .04	.39	.34	.65	
12 x 0,75	10,5	9,3	16,5	FI-VH-12x0.75-W69
.47 x .03	.41	.37	.65	
14 x 1	12	10,2	18	FI-VH-14x1-W69
.55 x .04	.47	.40	.71	
15 x 1,5	12	10,2	17	FI-VH-15x1.5-W69
.59 x .06	.47	.40	.67	
15 x 1	13	11,2	17	FI-VH-15x1-W69
.59 x .04	.51	.44	.67	
18 x 1,5	15	13,2	17,5	FI-VH-18x1.5-W69
.71 x .06	.59	.52	.69	
18 x 1	16	14,2	17,5	FI-VH-18x1-W69
.71 x .04	.63	.56	.69	
20 x 1	18	16,2	22	FI-VH-20x1-W69
.79 x .04	.71	.64	.87	
22 x 1,5	19	17,2	18	FI-VH-22x1.5-W69
.87 x .06	.75	.68	.71	
22 x 1	20	18,2	18	FI-VH-22x1-W69
.87 x .04	.79	.72	.71	
25 x 1,5	22	20,2	23,5	FI-VH-25x1.5-W69
.98 x .06	.87	.80	.93	
25 x 1	23	21,2	23,5	FI-VH-25x1-W69
.98 x .04	.91	.83	.93	
28 x 2	24	22,2	23,5	FI-VH-28x2-W69
1.10 x .08	.94	.87	.93	
28 x 1,5	25	23,2	23,5	FI-VH-28x1.5-W69
1.10 x .06	.98	.91	.93	
28 x 1	26	24,2	23,5	FI-VH-28x1-W69
1.10 x .04	1.02	.95	.93	
35 x 2	31	28,8	23,5	FI-VH-35x2-W69
1.38 x .08	1.22	1.13	.93	
35 x 1,5	32	29,8	23,5	FI-VH-35x1.5-W69
1.38 x .06	1.26	1.17	.93	
35 x 1	33	30,8	23,5	FI-VH-35x1-W69
1.38 x .04	1.30	1.21	.93	
42 x 2	38	35,8	23,5	FI-VH-42x2-W69
1.65 x .08	1.50	1.41	.93	
42 x 1,5	39	36,8	23,5	FI-VH-42x1.5-W69
1.65 x .06	1.54	1.45	.93	

## Ordering Codes

**\*FI-VH\*-10\*x1.5\*-W69**

* Support Sleeve	FI-VH
* Outside Tube Diameter (in mm)	-10
* Wall Thickness (in mm)	x1.5
* Material Code Brass	-W69

Please contact STAUFF for alternative materials and surface finishings.



**STAUFF Form EVO Sealing Ring**  
Type FI-FD • Series L / S

B

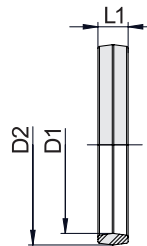

**Ordering Codes**

**\*FI-FD\*-15\*L\*-V90**

- \* STAUFF Form EVO Sealing Ring **FI-FD**
- \* Outside Tube Diameter D1 (in mm) **-15**
- \* Series **L**  
**S**
- Light Series
- Heavy Series
- \* Seal Material **-V90**  
**S**
- FKM (Viton®) 90 Shore

Please contact STAUFF for alternative materials and surface finishings.

Series	Tube OD		PN		Dimensions		Weight (kg/lbs) ca. per 100	Ordering Codes
	(mm/in)	(mm/in)	(bar/psi)	(mm/in)	D1	D2		
L	6	500	7,8		2,6		0,01	FI-FD-06L/S-V90
	.24	7250	.31		.10		.02	
	8	500	9,8		2,6		0,01	FI-FD-08L/S-V90
	.31	7250	.39		.10		.03	
	10	500	12		2,8		0,02	FI-FD-10L/S-V90
	.39	7250	.47		.11		.04	
	12	400	14		2,8		0,02	FI-FD-12L/S-V90
	.47	5800	.55		.11		.05	
	15	400	17		2,8		0,03	FI-FD-15L-V90
	.59	5800	.67		.11		.06	
	18	400	20		2,8		0,03	FI-FD-18L-V90
	.71	5800	.79		.11		.07	
	22	250	24		2,8		0,04	FI-FD-22L-V90
	.87	3625	.94		.11		.08	
	28	250	30		2,8		0,05	FI-FD-28L-V90
	1.10	3625	1.18		.11		.10	
	35	250	37,8		3,4		0,10	FI-FD-35L-V90
	1.38	3625	1.49		.13		.22	
42	250	44,8		3,4		0,12	FI-FD-42L-V90	
1.65	3625	1.76		.13		.27		
S	6	800	7,8		2,6		0,01	FI-FD-06L/S-V90
	.24	11600	.31		.10		.02	
	8	800	9,8		2,6		0,01	FI-FD-08L/S-V90
	.31	11600	.39		.10		.03	
	10	800	12		2,8		0,02	FI-FD-10L/S-V90
	.39	11600	.47		.11		.04	
	12	630	14		2,8		0,02	FI-FD-12L/S-V90
	.47	9135	.55		.11		.05	
	16	630	18		2,8		0,03	FI-FD-16S-V90
	.63	9135	.71		.11		.06	
	20	400	22,6		3,4		0,05	FI-FD-20S-V90
	.79	5800	.89		.13		.12	
	25	400	27,6		3,4		0,07	FI-FD-25S-V90
	.98	5800	1.09		.13		.15	
	30	400	32,8		3,4		0,09	FI-FD-30S-V90
	1.18	5800	1.29		.13		.19	
	38	400	40,8		3,4		0,11	FI-FD-38S-V90
	1.50	5800	1.61		.13		.24	

Standard seal material is FKM (Viton®).



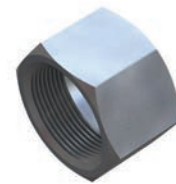
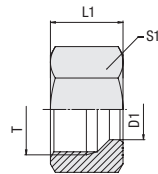

**Union Nut**  
**Type FI-M • Series LL / L / S**

**B**

Series	Tube OD		PN (bar/PSI)	Dimensions (mm/in)			Weight (kg/lbs) ca. per 100	Ordering Codes
	D1			Thread T	L1	S1		
LL	4	100		M 8 x 1	11	10	0,40	FI-M-04LL-W3
	.16	1450			.43	.39	.88	
	6	100		M 10 x 1	11,5	12	0,50	FI-M-06LL-W3
	.24	1450			.45	.47	1.10	
	8	100		M 12 x 1	12	14	0,70	FI-M-08LL-W3
	.31	1450			.47	.55	1.54	
	10	100		M 14 x 1	12,5	17	1,10	FI-M-10LL-W3
	.39	1450			.49	.67	2.42	
	12	100		M 16 x 1	13	19	1,30	FI-M-12LL-W3
	.47	1450			.51	.75	2.86	
L	6	500		M 12 x 1,5	14,5	14	0,90	FI-M-06L-W3
	.24	7250			.57	.55	1.98	
	8	500		M 14 x 1,5	14,5	17	1,40	FI-M-08L-W3
	.31	7250			.57	.67	3.08	
	10	500		M 16 x 1,5	15,5	19	1,70	FI-M-10L-W3
	.39	7250			.61	.75	3.74	
	12	400		M 18 x 1,5	15,5	22	2,40	FI-M-12L-W3
	.47	5800			.61	.87	5.28	
	15	400		M 22 x 1,5	17	27	4,10	FI-M-15L-W3
	.59	5800			.67	1.06	9.02	
	18	400		M 26 x 1,5	18	32	6,00	FI-M-18L-W3
	.71	5800			.71	1.26	13.20	
	22	250		M 30 x 2	20	36	8,00	FI-M-22L-W3
	.87	3625			.79	1.42	17.60	
	28	250		M 36 x 2	22	41	14,20	FI-M-28L-W3
	1.10	3625			.87	1.61	31.24	
	35	250		M 45 x 2	25	50	19,80	FI-M-35L-W3
	1.38	3625			.98	1.97	43.56	
42	250		M 52 x 2	25	60	22,00	FI-M-42L-W3	
1.65	3625			.98	2.36	48.40		
S	6	800		M 14 x 1,5	16,5	17	1,70	FI-M-06S-W3
	.24	11600			.65	.67	3.74	
	8	800		M 16 x 1,5	16,5	19	2,00	FI-M-08S-W3
	.31	11600			.65	.75	4.40	
	10	800		M 18 x 1,5	17,5	22	3,00	FI-M-10S-W3
	.39	11600			.69	.87	6.60	
	12	630		M 20 x 1,5	17,5	24	3,40	FI-M-12S-W3
	.47	9135			.69	.94	7.48	
	14	630		M 22 x 1,5	20,5	27	5,20	FI-M-14S-W3
	.55	9135			.81	1.06	11.44	
	16	630		M 24 x 1,5	20,5	30	6,50	FI-M-16S-W3
	.63	9135			.81	1.18	14.30	
	20	420		M 30 x 2	24	36	10,10	FI-M-20S-W3
	.79	6091			.94	1.42	22.22	
	25	420		M 36 x 2	27	46	19,80	FI-M-25S-W3
	.98	6091			1.06	1.81	43.56	
	30	420		M 42 x 2	29	50	21,60	FI-M-30S-W3
	1.18	6091			1.14	1.97	47.52	
38	420		M52 x 2	32,5	60	31,40	FI-M-38S-W3	
1.50	6091			1.28	2.36	69.08		

**Ordering Codes**
**\*FI-M\*-15\*L\*-W3**

* Union Nut		<b>FI-M</b>
* Outside Tube Diameter D1 (in mm)		<b>-15</b>
* Series	Extra-Light Series	<b>LL</b>
	Light Series	<b>L</b>
	Heavy Series	<b>S</b>
* Material Code	Steel, zinc/nickel-plated	<b>-W3</b>

Please contact STAUFF for alternative materials and surface finishings.



## 24°/37° Flared Cone Adaptor with O-Rings Type FI-BA ▪ Series L / S

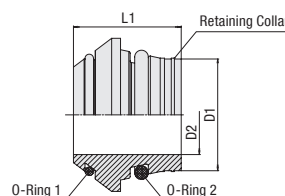

B

### Ordering Codes

**\*FI-BA\*-10\*L\*-V\*-W3**

\* 24°/37° Flared Cone Adaptor with O-Rings

**FI-BA**

\* Outside Tube Diameter D1 (in mm)

**-10**

\* Series  
Light Series  
Heavy Series

**L**

**S**

\* Seal Material  
FKM (Viton®)  
EPDM

**-V**

**-E**

\* Material Code  
Steel, zinc/nickel-plated

**-W3**

Please contact STAUFF for alternative materials and surface finishings.

### Spare Parts / Accessories



O-Ring  
Type **O-RING**

Page 240

Series	Tube OD PN		Dimensions				Weight ( <sup>kg</sup> /lbs) ca. per 100	Ordering Codes
	(mm/in) D1	( <sup>bar</sup> /psi)	(mm/in) D2	L1	O-Ring 1	O-Ring 2		
L	6	500	3	11,5	4,4 x 0,8	4,5 x 1,5	0,28	FI-BA-06L/S-V-W3
	.24	7250	.12	.45	.17 x .03	.18 x .06	.62	
	8	500	5	12	6,0 x 0,8	6,5 x 1,5	0,40	FI-BA-08L/S-V-W3
	.31	7250	.20	.47	.24 x .03	.26 x .06	.89	
	10	500	6	12,5	7,5 x 0,8	8,5 x 1,5	0,65	FI-BA-10L/S-V-W3
	.39	7250	.24	.49	.30 x .03	.33 x .06	1.43	
	12	400	8	12,5	9,5 x 0,8	10,0 x 1,5	0,80	FI-BA-12L/S-V-W3
	.47	5800	.31	.49	.37 x .03	.39 x .06	1.76	
	15	400	11	12,5	12,5 x 0,8	12,5 x 2,0	1,05	FI-BA-15L-V-W3
	.59	5800	.43	.49	.49 x .03	.49 x .08	2.31	
	18	400	14	13	15,0 x 1,0	16,0 x 2,0	1,26	FI-BA-18L-V-W3
	.71	5800	.55	.51	.59 x .04	.63 x .08	2.77	
	22	250	17	14,2	18,0 x 1,0	20,0 x 2,0	2,01	FI-BA-22L-V-W3
	.87	3625	.67	.56	.71 x .04	.79 x .08	4.43	
	28	250	23	14,7	23,0 x 1,0	26,0 x 2,0	2,82	FI-BA-28L-V-W3
	1.10	3625	.91	.58	.91 x .04	1.02 x .08	6.20	
	35	250	28	18,5	30,0 x 1,0	32,0 x 2,5	5,86	FI-BA-35L-V-W3
1.38	3625	1.10	.73	1.18 x .04	1.26 x .10	12.88		
42	250	35	20,5	37,0 x 1,0	38,0 x 2,5	4,40	FI-BA-42L-V-W3	
1.65	3625	1.38	.81	1.46 x .04	1.50 x .10	9.69		
S	6	630	3	11,5	4,4 x 0,8	4,5 x 1,5	0,28	FI-BA-06L/S-V-W3
	.24	9135	.12	.45	.17 x .03	.18 x .06	.62	
	8	630	5	12	6,0 x 0,8	6,5 x 1,5	0,40	FI-BA-08L/S-V-W3
	.31	9135	.20	.47	.24 x .03	.26 x .06	.89	
	10	630	6	12,5	7,5 x 0,8	8,5 x 1,5	0,65	FI-BA-10L/S-V-W3
	.39	9135	.24	.49	.30 x .03	.33 x .06	1.43	
	12	630	8	12,5	9,5 x 0,8	10,0 x 1,5	0,80	FI-BA-12L/S-V-W3
	.47	9135	.31	.49	.37 x .03	.39 x .06	1.76	
	14	630	9	14	11,0 x 1,0	12,0 x 2,0	1,20	FI-BA-14S-V-W3
	.55	9135	.35	.55	.43 x .04	.47 x .08	2.63	
	16	630	11	15	12,5 x 1,0	14,0 x 2,0	1,50	FI-BA-16S-V-W3
	.63	9135	.43	.59	.49 x .04	.55 x .08	3.30	
	20	400	14	18,5	16,0 x 1,0	17,3 x 2,4	2,73	FI-BA-20S-V-W3
	.79	5800	.55	.73	.63 x .04	.68 x .09	6.00	
	25	400	19	20	20,0 x 1,0	22,3 x 2,4	3,78	FI-BA-25S-V-W3
	.98	5800	.75	.79	.79 x .04	.88 x .09	8.32	
	30	400	23	22	25,0 x 1,0	27,3 x 2,4	3,82	FI-BA-30S-V-W3
1.18	5800	.91	.87	.98 x .04	1.07 x .09	8.41		
38	400	30	26	32,0 x 1,8	35,0 x 2,4	9,15	FI-BA-38S-V-W3	
1.50	5800	1.18	1.02	1.26 x .07	1.38 x .09	20.13		

Standard seal material is FKM (Viton®).

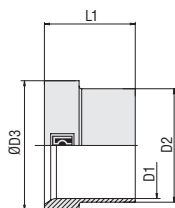

Support Sleeve for 37° Flared Tube Fittings  
 Type FI-BH ■ Series L / S

B

Series	Tube OD PN		Dimensions			Weight ( <sup>kg</sup> / <sub>lbs</sub> ) ca. per 100	Ordering Codes
	(mm/in)	( <sup>bar</sup> / <sub>PSI</sub> )	(mm/in)	D1	D2		
L	6	500	7,6	10,2	10	0,21	FI-BH-06L/S-W3
	.24	7250	.30	.40	.39	.46	
	8	500	9,3	12,2	11	0,25	FI-BH-08L/S-W3
	.31	7250	.37	.48	.43	.56	
	10	500	11,5	14,2	12	0,37	FI-BH-10L/S-W3
	.39	7250	.45	.56	.47	.82	
	12	400	13,6	16,2	12,5	0,46	FI-BH-12L/S-W3
	.47	5800	.54	.64	.49	1.01	
	15	400	17,5	20,2	13,5	0,89	FI-BH-15L-W3
	.59	5800	.69	.80	.53	1.96	
	18	400	21	24,2	14	1,40	FI-BH-18L-W3
	.71	5800	.83	.95	.55	3.08	
	22	250	24,2	27,8	17,5	1,59	FI-BH-22L-W3
	.87	3625	.95	1.09	.69	3.49	
	28	250	30,2	33,8	16,5	1,99	FI-BH-28L-W3
	1.10	3625	1.19	1.33	.65	4.38	
	35	250	38	42,7	18,5	3,70	FI-BH-35L-W3
	1.38	3625	1.50	1.68	.73	8.14	
42	250	45	49,7	20,5	4,94	FI-BH-42L-W3	
1.65	3625	1.77	1.96	.81	10.86		
S	6	630	7,6	10,2	10	0,21	FI-BH-06L/S-W3
	.24	9135	.30	.40	.39	.46	
	8	630	9,3	12,2	11	0,25	FI-BH-08L/S-W3
	.31	9135	.37	.48	.43	.56	
	10	630	11,5	14,2	12	0,37	FI-BH-10L/S-W3
	.39	9135	.45	.56	.47	.82	
	12	630	13,6	16,2	12,5	0,46	FI-BH-12L/S-W3
	.47	9135	.54	.64	.49	1.01	
	14	630	17,5	20,2	14	1,20	FI-BH-14S-W3
	.55	9135	.69	.80	.55	2.63	
	16	630	18,5	22	16,5	1,25	FI-BH-16S-W3
	.63	9135	.73	.87	.65	2.74	
	20	400	24,2	27,8	17	2,39	FI-BH-20S-W3
	.79	5800	.95	1.09	.67	5.26	
	25	400	28,5	32,8	19,5	2,98	FI-BH-25S-W3
	.98	5800	1.12	1.29	.77	6.55	
	30	400	34	39	21	4,50	FI-BH-30S-W3
	1.18	5800	1.34	1.54	.83	9.91	
38	400	42	48,5	26	7,34	FI-BH-38S-W3	
1.50	5800	1.65	1.91	1.02	16.15		

## Ordering Codes

**\*FI-BH\*-15\*L\*-W3**

 \* Support Sleeve for 37° Flared Tube Fittings **FI-BH**

 \* Outside Tube Diameter D1 (in mm) **-15**

 \* Series Light Series **L**  
 Heavy Series **S**

 \* Material Code Steel, zinc/nickel-plated **-W3**

Please contact STAUFF for alternative materials and surface finishings.



**Union Nut for 37° Flared Tube Fittings**  
**Type FI-BM ▪ Series L / S**

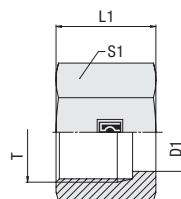

B

**Ordering Codes**

**\*FI-BM\*-15\*L\*-W3**

\* Union Nut for 37° Flared Tube Fittings

\* Outside Tube Diameter D1 (in mm)

\* Series                    Light Series  
                                   Heavy Series

\* Material Code        Steel, zinc/nickel-plated

Please contact STAUFF for alternative materials and surface finishings.

**FI-BM**  
**-15**  
**L**  
**S**  
**-W3**

Series	Tube OD PN		Dimensions				Weight ( <sup>kg</sup> / <sub>lbs</sub> ) ca. per 100	Ordering Codes
	( <sup>mm</sup> / <sub>in</sub> )	( <sup>bar</sup> / <sub>psi</sub> )	( <sup>mm</sup> / <sub>in</sub> ) Thread T	D1	L1	S1		
L	6	500	M 12 x 1,5	7,8	17	14	1,07	FI-BM-06L-W3
	.24	7250		.31	.67	.55	2.35	
	8	500	M 14 x 1,5	9,5	18	17	1,82	FI-BM-08L-W3
	.31	7250		.37	.71	.67	4.01	
	10	500	M 16 x 1,5	11,7	19,5	19	2,35	FI-BM-10L-W3
	.39	7250		.46	.77	.75	5.18	
	12	400	M 18 x 1,5	13,8	20,5	22	3,36	FI-BM-12L-W3
	.47	5800		.54	.81	.87	7.38	
	15	400	M 22 x 1,5	17,7	23	27	5,31	FI-BM-15L-W3
	.59	5800		.70	.91	1.06	11.68	
	18	400	M 26 x 1,5	21,2	23	32	7,22	FI-BM-18L-W3
	.71	5800		.83	.91	1.26	15.88	
	22	250	M 30 x 2	24,4	27,5	36	10,60	FI-BM-22L-W3
	.87	3625		.96	1.08	1.42	23.32	
	28	250	M 36 x 2	30,4	27,5	41	11,47	FI-BM-28L-W3
	1.10	3625		1.20	1.08	1.61	25.24	
	35	250	M 45 x 2	38,3	30	50	16,27	FI-BM-35L-W3
	1.38	3625		1.51	1.18	1.97	35.80	
42	250	M 52 x 2	45,3	34	60	30,39	FI-BM-42L-W3	
1.65	3625		1.78	1.34	2.36	66.86		
S	6	630	M 14 x 1,5	7,8	18	17	2,03	FI-BM-06S-W3
	.24	9135		.31	.71	.67	4.46	
	8	630	M 16 x 1,5	9,5	19	19	2,52	FI-BM-08S-W3
	.31	9135		.37	.75	.75	5.54	
	10	630	M 18 x 1,5	11,7	20,5	22	3,58	FI-BM-10S-W3
	.39	9135		.46	.81	.87	7.88	
	12	630	M 20 x 1,5	13,8	21	24	4,11	FI-BM-12S-W3
	.47	9135		.54	.83	.94	9.05	
	14	630	M 22 x 1,5	17,7	23	27	5,38	FI-BM-14S-W3
	.55	9135		.70	.91	1.06	11.84	
	16	630	M 24 x 1,5	18,7	26,5	30	7,87	FI-BM-16S-W3
	.63	9135		.74	1.04	1.18	17.31	
	20	400	M 30 x 2	24,4	27,5	36	10,61	FI-BM-20S-W3
	.79	5800		.96	1.08	1.42	23.35	
	25	400	M 36 x 2	28,7	30,5	46	22,19	FI-BM-25S-W3
	.98	5800		1.13	1.20	1.81	48.81	
	30	400	M 42 x 2	34,2	32	50	23,20	FI-BM-30S-W3
	1.18	5800		1.35	1.26	1.97	51.04	
38	400	M 52 x 2	42,3	38	60	35,40	FI-BM-38S-W3	
1.50	5800		1.67	1.50	2.36	77.89		

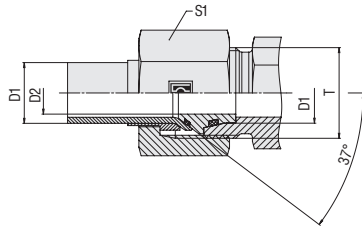

**37° Flared Tube Fitting Set  
Type FI-AB ■ Series L / S**

**B**

Series	Tube OD		Dimensions (mm/in)	D2	S1	Weight (kg/lbs) ca. per 100	Ordering Codes
	(mm/in)	(bar/PSI)					
L	6	500	M 12 x 1,5	3	14	1,74	FI-AB-06L-V-W3
	.24	7250		.12	.55	3,83	
	8	500	M 14 x 1,5	5	17	2,50	FI-AB-08L-V-W3
	.31	7250		.20	.67	5,50	
	10	500	M 16 x 1,5	6	19	3,38	FI-AB-10L-V-W3
	.39	7250		.24	.75	7,43	
	12	400	M 18 x 1,5	8	22	4,83	FI-AB-12L-V-W3
	.47	5800		.31	.87	10,62	
	15	400	M 22 x 1,5	11	27	4,66	FI-AB-15L-V-W3
	.59	5800		.43	1,06	10,24	
	18	400	M 26 x 1,5	14	32	10,11	FI-AB-18L-V-W3
	.71	5800		.55	1,26	22,25	
	22	250	M 30 x 2	17	36	14,25	FI-AB-22L-V-W3
	.87	3625		.67	1,42	31,35	
	28	250	M 36 x 2	23	41	16,47	FI-AB-28L-V-W3
	1.10	3625		.91	1,61	36,23	
	35	250	M 45 x 2	28	50	25,86	FI-AB-35L-V-W3
	1.38	3625		1.10	1,97	56,90	
42	250	M 52 x 2	35	60	42,85	FI-AB-42L-V-W3	
1.65	3625		1.38	2,36	94,27		
S	6	630	M 14 x 1,5	3	17	2,51	FI-AB-06S-V-W3
	.24	9135		.12	.67	5,53	
	8	630	M 16 x 1,5	5	19	3,39	FI-AB-08S-V-W3
	.31	9135		.20	.75	7,46	
	10	630	M 18 x 1,5	6	22	4,77	FI-AB-10S-V-W3
	.39	9135		.24	.87	10,49	
	12	630	M 20 x 1,5	8	24	5,63	FI-AB-12S-V-W3
	.47	9135		.31	.94	12,39	
	14	630	M 22 x 1,5	9	27	7,77	FI-AB-14S-V-W3
	.55	9135		.35	1,06	17,10	
	16	630	M 24 x 1,5	11	30	10,88	FI-AB-16S-V-W3
	.63	9135		.43	1,18	23,94	
	20	400	M 30 x 2	14	36	15,90	FI-AB-20S-V-W3
	.79	5800		.55	1,42	34,98	
	25	400	M 36 x 2	19	46	29,34	FI-AB-25S-V-W3
	.98	5800		.75	1,81	64,54	
	30	400	M 42 x 2	23	50	33,64	FI-AB-30S-V-W3
	1.18	5800		.91	1,97	74,00	
38	400	M 52 x 2	30	60	52,40	FI-AB-38S-V-W3	
1.50	5800		1.18	2,36	115,28		

Standard seal material is FKM (Viton®).

**Ordering Codes**
**\*FI-AB\*-15\*L\*-V\*-W3**

* 37° Flared Tube Fitting Set		<b>FI-AB</b>
* Outside Tube Diameter D1 (in mm)		<b>-15</b>
* Series	Light Series	<b>L</b>
	Heavy Series	<b>S</b>
* Seal Material	FKM (Viton®)	<b>-V</b>
	EPDM	<b>-E</b>
* Material Code	Steel, zinc/nickel-plated	<b>-W3</b>

Please contact STAUFF for alternative materials and surface finishings.

**Spare Parts / Accessories**

 O-Ring  
Type **O-RING**

Page 240





**Straight Male Stud Fitting** 40-73

FI-GE



**Whitworth Parallel Pipe Thread (BSPP) /  
Metallic Sealing Edge** 40  
FI-GE-...-R



**Metric Parallel Thread /  
Metallic Sealing Edge** 44  
FI-GE-...-M



**Whitworth Parallel Pipe Thread (BSPP) /  
Profile Sealing Ring** 48  
FI-GE-...-R-WD



**Metric Parallel Thread /  
Profile Sealing Ring** 52  
FI-GE-...-M-WD



**BSPP Thread / 60° Conical Bore /  
Sealing Surface for Gaskets** 55  
FI-GE-...-R-DF



**Metric Parallel Thread /  
O-Ring** 57  
FI-GE-...-M-OR



**Whitworth Taper Pipe Thread (BSPT)** 60  
FI-GE-...-Rk



**Metric Taper Thread** 64  
FI-GE-...-Mk



**NPT Thread** 65  
FI-GE-...-N



**UN/UNF Thread /  
O-Ring** 70  
FI-GE-...-U

**Male Stud Elbow** 74-81  
 FI-WE

**Whitworth Parallel Pipe Thread (BSPP) /  
 Metallic Sealing Edge** 74  
 FI-WE-...-R

**Metric Parallel Thread /  
 Metallic Sealing Edge** 75  
 FI-WE-...-M

**Whitworth Taper Pipe Thread (BSPT)** 76  
 FI-WE-...-Rk

**Metric Taper Thread** 78  
 FI-WE-...-Mk

**NPT Thread** 80  
 FI-WE-...-N

**Male Stud Branch Tee** 82-87  
 FI-TE

**Whitworth Parallel Pipe Thread (BSPP) /  
 Metallic Sealing Edge** 82  
 FI-TE-...-R

**Metric Parallel Thread /  
 Metallic Sealing Edge** 83  
 FI-TE-...-M

**Whitworth Taper Pipe Thread (BSPT)** 84  
 FI-TE-...-Rk

**Metric Taper Thread** 85  
 FI-TE-...-Mk

**NPT Thread** 86  
 FI-TE-...-N

**Male Stud Barrel Tee** 88-93  
 FI-LE

**Whitworth Parallel Pipe Thread (BSPP) /  
 Metallic Sealing Edge** 88  
 FI-LE-...-R

**Metric Parallel Thread /  
 Metallic Sealing Edge** 89  
 FI-LE-...-M

**Whitworth Taper Pipe Thread (BSPT)** 90  
 FI-LE-...-Rk

**Metric Taper Thread** 91  
 FI-LE-...-Mk

**NPT Thread** 92  
 FI-LE-...-N

**Straight Male Stud Fitting**  
Type FI-GE-...-R • Series LL / L

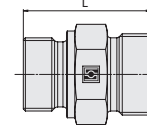
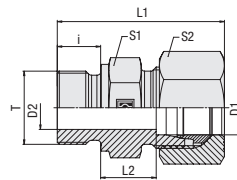

C

**Ordering Codes**

**\*FI-GE\*-10\*L\*R\*-W3\*-MS**

- \* Straight Male Stud Fitting **FI-GE**
- \* Outside Tube Diameter D1 (in mm) **-10**
- \* Series **LL** Extra-Light Series (page 40)  
**L** Light Series (pages 40/41)  
**S** Heavy Series (pages 42/43)
- \* Thread Type **R** Whitworth Parallel Pipe Thread (BSPP)
- If required, please indicate special sizes, e.g. R1/8!
- \* Material Code **-W3** Steel, zinc/nickel-plated
- Please contact STAUFF for alternative materials and surface finishings.
- \* Assembling / Kitting **—** Fitting body only  
**-MS** Fitting body supplied with cutting ring and union nut  
**-MSV** Fitting body supplied with soft-sealing cutting ring and union nut

**Connecting Parts**

-  Cutting Ring  
Type **FI-DS** Page 28
-  Soft-Sealing Cutting Ring  
Type **FI-WDDS** Page 29
-  Support Sleeve  
Type **FI-VH** Page 31
-  STAUFF Form EVO Sealing Ring  
Type **FI-FD** Page 32
-  Union Nut  
Type **FI-M** Page 33
-  37° Flared Tube Fitting Set  
Type **FI-AB** Page 37

**Whitworth Parallel Pipe Thread (BSPP)**

**Metallic Sealing Edge**

Series	Tube OD (mm/in)	PN (bar/psi)	Dimensions (mm/in)	Thread T	D2	i	L	L1 <sup>1</sup>	L2	S1	S2	Torque (N·m/ft-lb)	Weight (kg/lbs) ca.	Ordering Codes <sup>3</sup>
LL	4	100	G 1/8	3	8	21,5	25,5	9,5	14	10	25	1,17		FI-GE-04LLR-W3
	.16	1450	G 1/8	.12	.31	.85	1.00	.37	.55	.39	18.4	2.58		FI-GE-06LLR-W3
	6	100	G 1/8	4	8	21,5	25,5	8	14	12	25	1,16		FI-GE-08LLR-W3
	.24	1450	G 1/8	.16	.31	.85	1.00	.31	.55	.47	18.4	2.56		FI-GE-10LLR-W3
	8	100	G 1/8	4	8	22,5	26,5	9	14	14	25	1,33		FI-GE-10LLR-W3
	.31	1450	G 1/8	.16	.31	.89	1.04	.35	.55	.55	18.4	2.93		FI-GE-10LLR-W3
L	10	100	G 1/4	6	12	28	35	10,5	19	17	55	2,66		FI-GE-06LR-W3
	.39	1450	G 1/4	.24	.47	1.10	1.38	.41	.75	.67	40.5	5.86		FI-GE-06LR1/4-W3
	6	400	G 1/8	4	8	23,5	31,5	8,5	14	14	25	1,37		FI-GE-06LR1/4-W3
	.24	5800	G 1/4	.16	.31	.93	1.24	.33	.55	.55	18.4	3.01		FI-GE-06LR3/8-W3
	6	400	G 1/4	4	12	29	37	10	19	14	55	2,84		FI-GE-06LR1/2-W3
	.24	5800	G 3/8	.16	.47	1.14	1.46	.39	.75	.55	40.5	6.24		FI-GE-06LR3/8-W3
	6	400	G 3/8	4	12	30,5	38,5	11,5	22	14	95	4,13		FI-GE-06LR1/2-W3
	.24	5800	G 1/2	.16	.55	1.30	1.61	.47	1.06	.55	136.5	14.26		FI-GE-08LR1/8-W3
	8	400	G 1/8	4	8	24,5	32,5	9,5	14	17	25	1,61		FI-GE-08LR1/8-W3
	.31	5800	G 1/8	.16	.31	.96	1.28	.37	.55	.67	18.4	3.54		FI-GE-08LR-W3
	8	400	G 1/4	6	12	29	37	10	19	17	55	2,72		FI-GE-08LR3/8-W3
	.31	5800	G 3/8	.24	.47	1.14	1.46	.39	.75	.67	40.5	5.97		FI-GE-08LR1/2-W3
	8	400	G 3/8	6	12	30,5	38,5	11	22	17	95	4,46		FI-GE-08LR1/2-W3
	.31	5800	G 1/2	.24	.47	1.20	1.52	.43	.87	.67	70.1	9.81		FI-GE-10LR1/8-W3
	8	400	G 1/2	6	14	33	41	12	27	17	185	7,51		FI-GE-10LR1/8-W3
	.31	5800	G 1/2	.24	.55	1.30	1.61	.47	1.06	.67	136.5	16.53		FI-GE-10LR3/8-W3
	10	400	G 1/8	4	8	25,5	33,5	10,5	17	19	25	2,00		FI-GE-10LR3/8-W3
	.39	5800	G 1/4	.16	.31	1.00	1.32	.41	.67	.75	18.4	4.40		FI-GE-10LR-W3
	10	400	G 1/4	6	12	30	38	11	19	19	55	2,95		FI-GE-10LR1/2-W3
	.39	5800	G 3/8	.24	.47	1.18	1.50	.43	.75	.75	40.5	6.48		FI-GE-10LR3/4-W3
	10	400	G 3/8	8	12	31,5	39,5	12,5	22	19	95	4,29		FI-GE-10LR1/2-W3
	.39	5800	G 1/2	.31	.55	1.34	1.65	.51	1.06	.75	136.5	15.58		FI-GE-10LR3/4-W3
	10	400	G 3/4	8	16	37,5	45,5	14,5	32	19	250	9,29		FI-GE-12LR1/8-W3
	.39	5800	G 1/8	.31	.63	1.48	1.79	.57	1.26	.75	184.4	20.43		FI-GE-12LR1/4-W3
12	400	G 1/8	4	8	26,5	34,5	11,5	19	22	25	2,49		FI-GE-12LR-W3	
.47	5800	G 1/4	.16	.31	1.04	1.36	.45	.75	.87	18.4	5.48		FI-GE-12LR1/2-W3	
12	400	G 1/4	6	12	31	39	12	19	22	55	3,10		FI-GE-12LR1/2-W3	
.47	5800	G 3/8	.24	.47	1.22	1.54	.47	.75	.87	40.5	6.81		FI-GE-12LR3/4-W3	
12	400	G 3/8	9	12	31,5	39,5	12,5	22	22	95	4,24		FI-GE-12LR-W3	
.47	5800	G 1/2	.35	.47	1.24	1.56	.49	.87	.87	70.1	9.32		FI-GE-12LR1/2-W3	
12	400	G 1/2	10	14	34	42	13	27	22	185	6,67		FI-GE-12LR1/2-W3	
.47	5800	G 3/4	.39	.55	1.34	1.65	.51	1.06	.87	136.5	14.68		FI-GE-12LR3/4-W3	
12	400	G 3/4	10	16	37	45	14	32	22	250	10,83		FI-GE-12LR3/4-W3	
.47	5800	G 3/4	.39	.63	1.46	1.77	.55	1.26	.87	184.4	23.83			

<sup>1</sup> Approximate dimension in assembled condition.  
<sup>2</sup> Weight excluding cutting ring and union nut.  
<sup>3</sup> Standard scope of delivery: Fitting body only.

Male stud acc. to DIN 3852-2 (Form B) / ISO 1179-4 (Type B)  
 Port acc. to DIN 3852-2 (Form X) / ISO 1179-1

Torque recommendations for Steel mating material.

Male threaded studs were designed for female threaded ports in components made of steel. For applications with components made of softer mating materials (e.g. Aluminium), the use of connectors with additionally rolled male threads is recommended.  
 Please contact STAUFF prior to the assembly for further information.





Straight Male Stud Fitting  
Type FI-GE-...-R • Series L

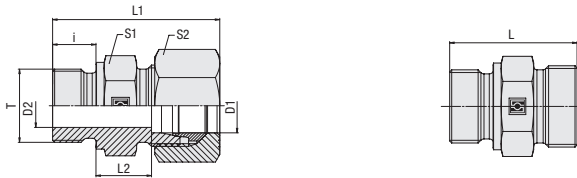

C

Metallic Sealing Edge Whitworth Parallel Pipe Thread (BSPP)

Series	Tube OD (mm/in)	PN (bar/psi)	Dimensions (mm/in)	Torque (Nm/ft-lb)	Weight (kg/lbs) ca.	Ordering Codes <sup>3</sup>
L	D1	Thread T	D2 i L L <sup>1</sup> L <sub>2</sub> S1 S2	Thread T	per 100	
15	400	G 1/4	6 12 33 41 14 24 27 55	55	4,93	FI-GE-15LR1/4-W3
.59	5800	G 1/4	.24 .47 1.30 1.61 .55 .94 1.06 40.5	40.5	10.85	FI-GE-15LR1/4-W3
15	400	G 3/8	9 12 32.5 4.5 13 24 27 95	95	5,03	FI-GE-15LR3/8-W3
.59	5800	G 3/8	.35 .47 1.28 1.59 .51 .94 1.06 70.1	70.1	11.06	FI-GE-15LR3/8-W3
15	400	G 1/2	11 14 35 43 14 27 27 185	185	6,53	FI-GE-15LR-W3
.59	5800	G 1/2	.43 .55 1.38 1.69 .55 1.06 1.06 136.5	136.5	14.37	FI-GE-15LR-W3
15	400	G 3/4	12 16 38 46 15 32 27 250	250	10,06	FI-GE-15LR3/4-W3
.59	5800	G 3/4	.47 .63 1.50 1.81 .59 1.26 1.06 184.4	184.4	22.14	FI-GE-15LR3/4-W3
18	200	G 3/8	9 12 33.5 42.5 14 27 32 95	95	6,41	FI-GE-18LR3/8-W3
.71	2900	G 3/8	.35 .47 1.32 1.67 .55 1.06 1.26 70.1	70.1	14.11	FI-GE-18LR3/8-W3
18	200	G 1/2	14 14 36 45 14.5 27 32 185	185	7,13	FI-GE-18LR-W3
.71	2900	G 1/2	.55 .55 1.42 1.77 .57 1.06 1.26 136.5	136.5	15.69	FI-GE-18LR-W3
18	200	G 3/4	15 16 38 47 14.5 32 32 250	250	11,28	FI-GE-18LR3/4-W3
.71	2900	G 3/4	.59 .63 1.50 1.85 .57 1.26 1.26 184.4	184.4	24.82	FI-GE-18LR3/4-W3
18	200	G 1	15 18 40 49 14.5 41 32 400	400	15,87	FI-GE-18LR1-W3
.71	2900	G 1	.59 .71 1.57 1.93 .57 1.61 1.26 295	295	34.91	FI-GE-18LR1-W3
22	200	G 1/2	14 14 38 47 16.5 32 36 185	185	8,57	FI-GE-22LR1/2-W3
.87	2900	G 1/2	.55 .55 1.50 1.85 .65 1.26 1.42 136.5	136.5	18.85	FI-GE-22LR1/2-W3
22	200	G 3/4	18 16 40 49 16.5 32 36 250	250	10,48	FI-GE-22LR-W3
.87	2900	G 3/4	.71 .63 1.57 1.93 .65 1.26 1.42 184.4	184.4	23.06	FI-GE-22LR-W3
22	200	G 1	19 18 43 52 17.5 41 36 400	400	19,17	FI-GE-22LR1-W3
.87	2900	G 1	.75 .71 1.69 2.05 .69 1.61 1.42 295	295	42.17	FI-GE-22LR1-W3
28	200	G 1/2	14 14 39 48 17.5 41 41 185	185	6,11	FI-GE-28LR1/2-W3
1.10	2900	G 1/2	.55 .55 1.54 1.89 .69 1.61 1.61 136.5	136.5	13.43	FI-GE-28LR1/2-W3
28	200	G 3/4	18 16 41 50 17.5 41 41 250	250	14,42	FI-GE-28LR3/4-W3
1.10	2900	G 3/4	.71 .63 1.61 1.97 .69 1.61 1.61 184.4	184.4	31.72	FI-GE-28LR3/4-W3
28	200	G 1	23 18 43 52 17.5 41 41 400	400	17,08	FI-GE-28LR-W3
1.10	2900	G 1	.91 .71 1.69 2.05 .69 1.61 1.61 295	295	37.58	FI-GE-28LR-W3
28	200	G 1 1/4	24 20 46 55 18.5 50 41 670	670	13,40	FI-GE-28LR1-1/4-W3
1.10	2900	G 1 1/4	.94 .79 1.81 2.17 .73 1.97 1.61 494.2	494.2	29.48	FI-GE-28LR1-1/4-W3
28	200	G 1 1/2	36 22 50 65 20.5 55 41 800	800	33,31	FI-GE-28LR1-1/2-W3
1.10	2900	G 1 1/2	1.42 .87 1.97 2.56 .81 2.17 1.61 590	590	73.44	FI-GE-28LR1-1/2-W3
35	200	G 1	23 18 46 57 17.5 46 50 400	400	22,45	FI-GE-35LR1-W3
1.38	2900	G 1	.91 .71 1.81 2.24 .69 1.81 1.97 295	295	49.38	FI-GE-35LR1-W3
35	200	G 1 1/4	30 20 48 59 17.5 50 50 670	670	27,69	FI-GE-35LR-W3
1.38	2900	G 1 1/4	1.18 .79 1.89 2.32 .69 1.97 1.97 494.2	494.2	60.92	FI-GE-35LR-W3
35	200	G 1 1/2	30 22 52 63 19.5 55 50 800	800	42,63	FI-GE-35LR1-1/2-W3
1.38	2900	G 1 1/2	1.18 .87 2.05 2.48 .77 2.17 1.97 590	590	93.78	FI-GE-35LR1-1/2-W3
42	200	G 1	23 18 48 60 19 55 60 400	400	32,20	FI-GE-42LR1-W3
1.65	2900	G 1	.91 .71 1.89 2.36 .75 2.17 2.36 295	295	70.84	FI-GE-42LR1-W3
42	200	G 1 1/4	30 20 50 62 19 55 60 670	670	34,71	FI-GE-42LR1-1/4-W3
1.65	2900	G 1 1/4	1.18 .79 1.97 2.44 .75 2.17 2.36 494.2	494.2	76.35	FI-GE-42LR1-1/4-W3
42	200	G 1 1/2	36 22 52 64 19 55 60 800	800	34,78	FI-GE-42LR-W3
1.65	2900	G 1 1/2	1.42 .87 2.05 2.52 .75 2.17 2.36 590	590	76.52	FI-GE-42LR-W3

### Ordering Codes

**\*FI-GE\*-10\*L\*R\*-W3\*-MS**

- \* Straight Male Stud Fitting **FI-GE**
- \* Outside Tube Diameter D1 (in mm) **-10**
- \* Series: Extra-Light Series (page 40) **LL**, Light Series (pages 40/41) **L**, Heavy Series (pages 42/43) **S**
- \* Thread Type: Whitworth Parallel Pipe Thread (BSPP) **R**

If required, please indicate special sizes, e.g. R1/8!

- \* Material Code: Steel, zinc/nickel-plated **-W3**

Please contact STAUFF for alternative materials and surface finishings.

- \* Assembling / Kitting: Fitting body only **—**, Fitting body supplied with cutting ring and union nut **-MS**, Fitting body supplied with soft-sealing cutting ring and union nut **-MSV**

### Connecting Parts

- Cutting Ring Type **FI-DS** Page 28
- Soft-Sealing Cutting Ring Type **FI-WDDS** Page 29
- Support Sleeve Type **FI-VH** Page 31
- STAUFF Form EVO Sealing Ring Type **FI-FD** Page 32
- Union Nut Type **FI-M** Page 33
- 37° Flared Tube Fitting Set Type **FI-AB** Page 37

<sup>1</sup> Approximate dimension in assembled condition. Male stud acc. to DIN 3852-2 (Form B) / ISO 1179-4 (Type B)  
<sup>2</sup> Weight excluding cutting ring and union nut. Port acc. to DIN 3852-2 (Form X) / ISO 1179-1  
<sup>3</sup> Standard scope of delivery: Fitting body only. Torque recommendations for Steel mating material.

Male threaded studs were designed for female threaded ports in components made of steel. For applications with components made of softer mating materials (e.g. Aluminium), the use of connectors with additionally rolled male threads is recommended. Please contact STAUFF prior to the assembly for further information.

**Straight Male Stud Fitting  
Type FI-GE-...-R • Series S**

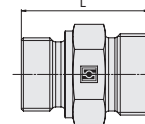
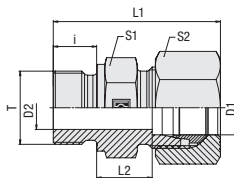

C

**Whitworth Parallel Pipe Thread (BSPP)**

**Metallic Sealing Edge**

**Ordering Codes**

**\*FI-GE\*-10\*S\*R\*-W3\*-MS**

* Straight Male Stud Fitting	<b>FI-GE</b>
* Outside Tube Diameter D1 (in mm)	<b>-10</b>
* Series	Extra-Light Series (page 40) <b>LL</b> Light Series (pages 40/41) <b>L</b> Heavy Series (pages 42/43) <b>S</b>
* Thread Type	Whitworth Parallel Pipe Thread (BSPP) <b>R</b>
If required, please indicate special sizes, e.g. R1/8!	
* Material Code	Steel, zinc/nickel-plated <b>-W3</b>
Please contact STAUFF for alternative materials and surface finishings.	
* Assembling / Kitting	Fitting body only <b>—</b>
	Fitting body supplied with cutting ring and union nut <b>-MS</b>
	Fitting body supplied with soft-sealing cutting ring and union nut <b>-MSV</b>

**Connecting Parts**

	Cutting Ring Type <b>FI-DS</b>	Page 28
	Soft-Sealing Cutting Ring Type <b>FI-WDDS</b>	Page 29
	Support Sleeve Type <b>FI-VH</b>	Page 31
	STAUFF Form EVO Sealing Ring Type <b>FI-FD</b>	Page 32
	Union Nut Type <b>FI-M</b>	Page 33
	37° Flared Tube Fitting Set Type <b>FI-AB</b>	Page 37

Series	Tube OD (mm/in)	PN (bar/psi)	Dimensions (mm/in)	Torque (Nm/ft-lb)	Weight (kg/lbs) ca.	Ordering Codes <sup>3</sup>							
	D1		Thread T	D2	i	L	L1 <sup>1</sup>	L2	S1	S2	Thread T		
S	6	500	G 1/8	4	8	28	36	13	17	17	30	2,55	FI-GE-06SR1/8-W3
	.24	7252		.16	.31	1.10	1.42	.51	.67	.67	22.1	5.62	
	6	630	G 1/4	4	12	32	40	13	19	17	80	3,49	FI-GE-06SR-W3
	.24	9135		.16	.47	1.26	1.57	.51	.75	.67	59	7.77	
	6	630	G 3/8	4	12	34,5	42,5	15,5	22	17	130	2,29	FI-GE-06SR3/8-W3
	.24	9135		.16	.47	1.36	1.67	.61	.87	.67	95.9	5.03	
	6	630	G 1/2	4	14	39	47	18	27	17	220	9,40	FI-GE-06SR1/2-W3
	.24	9135		.16	.55	1.54	1.85	.71	1.06	.67	162.3	20.68	
	8	630	G 1/4	5	12	34	42	15	19	19	80	4,06	FI-GE-08SR-W3
	.31	9135		.20	.47	1.34	1.65	.59	.75	.75	59	8.93	
	8	630	G 3/8	5	12	34,5	42,5	15,5	22	19	130	5,77	FI-GE-08SR3/8-W3
	.31	9135		.20	.47	1.36	1.67	.61	.87	.75	95.9	12.69	
	8	630	G 1/2	5	14	39	47	18	27	19	220	9,91	FI-GE-08SR1/2-W3
	.31	9135		.20	.55	1.54	1.85	.71	1.06	.75	162.3	21.80	
	10	630	G 1/4	5	12	34	43	14,5	19	22	80	4,35	FI-GE-10SR1/4-W3
	.39	9135		.20	.47	1.34	1.69	.57	.75	.87	59	9.57	
	10	630	G 3/8	7	12	34,5	43,5	15	22	22	130	5,68	FI-GE-10SR-W3
	.39	9135		.28	.47	1.36	1.71	.59	.87	.87	95.9	12.50	
	10	630	G 1/2	7	14	39	48	17,5	27	22	220	9,73	FI-GE-10SR1/2-W3
	.39	9135		.28	.55	1.54	1.89	.69	1.06	.87	162.3	21.41	
	12	630	G 1/4	5	12	36	45	16,5	22	24	80	5,93	FI-GE-12SR1/4-W3
	.47	9135		.20	.47	1.42	1.77	.65	.87	.94	59	13.05	
	12	630	G 3/8	8	12	36,5	45,5	17	22	24	130	5,02	FI-GE-12SR-W3
	.47	9135		.31	.47	1.44	1.79	.67	.87	.94	95.9	11.04	
	12	630	G 1/2	8	14	39	48	17,5	27	24	220	9,72	FI-GE-12SR1/2-W3
	.47	9135		.31	.55	1.54	1.89	.69	1.06	.94	162.3	21.38	
	12	630	G 3/4	8	16	43	52	19,5	32	24	350	16,48	FI-GE-12SR3/4-W3
	.47	9135		.31	.63	1.69	2.05	.77	1.26	.94	258.1	36.26	
	14	400	G 1/4	5	12	36	46	16	22	27	80	6,72	FI-GE-14SR1/4-W3
	.55	5800		.20	.47	1.42	1.81	.63	.87	1.06	59	14.78	
	14	400	G 3/8	8	12	38,5	48,5	18,5	22	27	130	6,95	FI-GE-14SR3/8-W3
	.55	5800		.31	.47	1.52	1.91	.73	.87	1.06	95.9	15.29	
	14	400	G 1/2	10	14	41	51	19	27	27	220	9,79	FI-GE-14SR-W3
	.55	5800		.39	.55	1.61	2.01	.75	1.06	1.06	162.3	21.54	
	14	400	G 3/4	10	16	45	55	21	32	27	350	16,30	FI-GE-14SR3/4-W3
	.55	5800		.39	.63	1.77	2.17	.83	1.26	1.06	258.1	35.86	
	16	400	G 3/8	8	12	38,5	48,5	18	27	30	130	6,42	FI-GE-16SR3/8-W3
	.63	5800		.31	.47	1.52	1.91	.71	1.06	1.18	95.9	14.12	
	16	400	G 1/2	12	14	41	51	18,5	27	30	220	9,15	FI-GE-16SR-W3
	.63	5800		.47	.55	1.61	2.01	.73	1.06	1.18	162.3	21.13	
	16	400	G 3/4	12	16	45	55	20,5	32	30	350	15,75	FI-GE-16SR3/4-W3
	.63	5800		.47	.63	1.77	2.17	.81	1.26	1.18	258.1	34.65	
	16	400	G 1	20	18	49	60	22,5	41	30	700	24,6	FI-GE-16SR1-W3
	.63	5800		.79	.71	1.93	2.36	.89	1.61	1.18	516.3	54.23	

<sup>1</sup> Approximate dimension in assembled condition.

<sup>2</sup> Weight excluding cutting ring and union nut.

<sup>3</sup> Standard scope of delivery: Fitting body only.

Male stud acc. to DIN 3852-2 (Form B) / ISO 1179-4 (Type B)  
Port acc. to DIN 3852-2 (Form X) / ISO 1179-1

Torque recommendations for Steel mating material.

Male threaded studs were designed for female threaded ports in components made of steel. For applications with components made of softer mating materials (e.g. Aluminium), the use of connectors with additionally rolled male threads is recommended.

Please contact STAUFF prior to the assembly for further information.

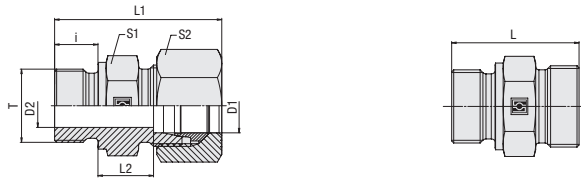

**Straight Male Stud Fitting  
Type FI-GE-...-R • Series S**

**C**
**Metallic Sealing Edge**
**Whitworth Parallel Pipe Thread (BSPP)**

Series	Tube OD (mm/in)	PN (bar/PSI)	Dimensions (mm/in)										Torque (Nm/ft-lb)	Weight (kg/lbs) ca. per 100	Ordering Codes <sup>3</sup>
			Thread	T	D2	i	L	L1 <sup>1</sup>	L2	S1	S2	Thread			
S	20	250	G 1/2	12	14	45	56	20.5	32	36	220	13.69	FI-GE-20SR1/2-W3		
	.79	3625		.47	.55	1.77	2.20	.81	1.26	1.42	162.3	30.11			
	20	250	G 3/4	16	16	47	58	20.5	32	36	350	15.24	FI-GE-20SR-W3		
	.79	3625		.63	.63	1.85	2.28	.81	1.26	1.42	258.1	33.54			
	20	250	G 1	16	18	51	62	22.5	41	36	700	25.90	FI-GE-20SR1-W3		
	.79	3625		.63	.71	2.01	2.44	.89	1.61	1.42	516.3	56.98			
	25	250	G 3/4	16	16	51	63	23	41	46	350	24.73	FI-GE-25SR3/4-W3		
	.98	3625		.63	.63	2.01	2.48	.91	1.61	1.81	258.1	54.40			
	25	250	G 1	20	18	53	65	23	41	46	700	26.89	FI-GE-25SR-W3		
	.98	3625		.79	.71	2.09	2.56	.91	1.61	1.81	516.3	59.16			
	25	250	G 1 1/4	20	20	55	67	23	50	46	850	23.28	FI-GE-25SR1-1/4-W3		
	.98	3625		.79	.79	2.17	2.64	.91	1.97	1.81	627	51.22			
	30	200	G 3/4	16	16	53	68	23.5	46	50	350	31.08	FI-GE-30SR3/4-W3		
	1.18	2900		.63	.63	2.09	2.68	.93	1.81	1.97	258.1	68.52			
	30	200	G 1	20	18	55	68	23.5	46	50	700	33.52	FI-GE-30SR1-W3		
	1.18	2900		.79	.71	2.17	2.68	.93	1.81	1.97	516.3	73.75			
	30	200	G 1 1/4	25	20	57	70	23.5	50	50	850	42.11	FI-GE-30SR-W3		
	1.18	2900		.98	.79	2.24	2.76	.93	1.97	1.97	627	92.65			
	30	200	G 1 1/2	25	22	59	72	23.5	55	50	1000	57.10	FI-GE-30SR1-1/2-W3		
	1.18	2900		.98	.87	2.32	2.83	.93	2.17	1.97	737.5	125.63			
	38	200	G 1	20	18	62	77	28	55	60	700	52.40	FI-GE-38SR1-W3		
	1.50	2900		.79	.71	2.44	3.03	1.10	2.17	2.36	516.3	115.28			
	38	200	G 1 1/4	25	20	62	75	26	55	60	850	57.22	FI-GE-38SR1-1/4-W3		
	1.50	2900		.98	.79	2.44	2.95	1.02	2.17	2.36	627	125.88			
38	200	G 1 1/2	32	22	64	77	26	55	60	1000	56.30	FI-GE-38SR-W3			
1.50	2900		1.26	.87	2.52	3.03	1.02	2.17	2.36	737.5	123.86				
38	200	G 2	32	24	66.5	83	26.5	75	60	1200	98.3	FI-GE-38SR2-W3			
1.50	2900		1.26	.94	2.62	3.27	1.04	2.95	2.36	885	216.7				

<sup>1</sup> Approximate dimension in assembled condition.

<sup>2</sup> Weight excluding cutting ring and union nut.

<sup>3</sup> Standard scope of delivery: Fitting body only.

Male stud acc. to DIN 3852-2 (Form B) / ISO 1179-4 (Type B)

Port acc. to DIN 3852-2 (Form X) / ISO 1179-1

Torque recommendations for Steel mating material.

Male threaded studs were designed for female threaded ports in components made of steel. For applications with components made of softer mating materials (e.g. Aluminium), the use of connectors with additionally rolled male threads is recommended.

Please contact STAUFF prior to the assembly for further information.

**Ordering Codes**
**\*FI-GE\*-10\*S\*R\*-W3\*-MS**

* Straight Male Stud Fitting	FI-GE
* Outside Tube Diameter D1 (in mm)	-10
* Series	Extra-Light Series (page 40) <b>LL</b> Light Series (pages 40/41) <b>L</b> Heavy Series (pages 42/43) <b>S</b>
* Thread Type	Whitworth Parallel Pipe Thread (BSPP) <b>R</b>

If required, please indicate special sizes, e.g. R1/8!

* Material Code	Steel, zinc/nickel-plated	-W3
-----------------	---------------------------	-----

Please contact STAUFF for alternative materials and surface finishings.

* Assembling / Kitting	Fitting body only	—
	Fitting body supplied with cutting ring and union nut	-MS
	Fitting body supplied with soft-sealing cutting ring and union nut	-MSV

**Connecting Parts**

	Cutting Ring Type <b>FI-DS</b>	Page 28
	Soft-Sealing Cutting Ring Type <b>FI-WDDS</b>	Page 29
	Support Sleeve Type <b>FI-VH</b>	Page 31
	STAUFF Form EVO Sealing Ring Type <b>FI-FD</b>	Page 32
	Union Nut Type <b>FI-M</b>	Page 33
	37° Flared Tube Fitting Set Type <b>FI-AB</b>	Page 37



## Straight Male Stud Fitting Type FI-GE-...-M • Series LL / L

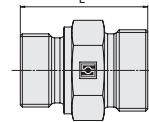
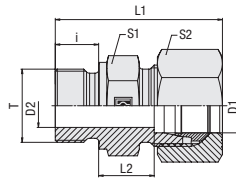

### Ordering Codes

#### \*FI-GE\*-10\*L\*M\*-W3\*-MS

* Straight Male Stud Fitting	<b>FI-GE</b>
* Outside Tube Diameter D1 (in mm)	<b>-10</b>
* Series	Extra-Light Series (page 44) <b>LL</b> Light Series (pages 44/45) <b>L</b> Heavy Series (page 46) <b>S</b>
* Thread Type	Metric Parallel Thread <b>M</b>
If required, please indicate special sizes, e.g. M12x1.5!	
* Material Code	Steel, zinc/nickel-plated <b>-W3</b>
Please contact STAUFF for alternative materials and surface finishings.	
* Assembling / Kitting	Fitting body only <b>—</b>  Fitting body supplied with cutting ring and union nut <b>-MS</b>  Fitting body supplied with soft-sealing cutting ring and union nut <b>-MSV</b>

### Connecting Parts

	Cutting Ring Type <b>FI-DS</b>	Page 28
	Soft-Sealing Cutting Ring Type <b>FI-WDDS</b>	Page 29
	Support Sleeve Type <b>FI-VH</b>	Page 31
	STAUFF Form EVO Sealing Ring Type <b>FI-FD</b>	Page 32
	Union Nut Type <b>FI-M</b>	Page 33
	37° Flared Tube Fitting Set Type <b>FI-AB</b>	Page 37

<sup>1</sup> Approximate dimension in assembled condition.  
<sup>2</sup> Weight excluding cutting ring and union nut.  
<sup>3</sup> Standard scope of delivery: Fitting body only.

Male stud acc. to DIN 3852-1 (Form B) / ISO 9974-3 (Type B)  
Port acc. to DIN 3852-1 (Form X) / ISO 9974-1

### Metric Parallel Thread

### Metallic Sealing Edge

Series	Tube OD (mm/in)	PN (bar/psi)	Dimensions (mm/in)	Torque (Nm/ft-lb)	Weight (kg/lbs) ca.	Ordering Codes <sup>3</sup>	
	D1		Thread T	Thread T	per 100		
LL	4	100	M 8 x 1	3 8 21,5 27 9,5 12 10 14	0,84	FI-GE-04LLM-W3	
	.16	1450		.12 .31 .85 1.06 .37 .47 .39 10.3 1.85			
	6	100	M 6 x 1	2 8 21,5 27 8 12 12 5	0,74	FI-GE-06LLM6x1-W3	
	.24	1450		.08 .31 .85 1.06 .31 .47 .47 3.7 1.63			
	6	100	M 8 x 1	3 8 21,5 27 8 12 12 14	0,88	FI-GE-06LLM8x1-W3	
	.24	1450		.12 .31 .85 1.06 .31 .47 .47 10.3 1.94			
	6	100	M 10 x 1	4,5 8 21,5 27 8 14 12 25	1,17	FI-GE-06LLM-W3	
	.24	1450		.18 .31 .85 1.06 .31 .55 .47 18.4 2.58			
	8	100	M 10 x 1	5 8 22,5 28 9 14 14 25	1,25	FI-GE-08LLM-W3	
	.31	1450		.2 .31 .89 1.10 .35 .55 .55 18.4 2.76			
	L	6	100	M 8 x 1	3 8 23,5 31 8,5 14 14 14	1,29	FI-GE-06LM8x1-W3
		.24	1450		.12 .31 .93 1.22 .33 .55 .55 10.3 2.84		
6		400	M 10 x 1	4 8 23,5 31,5 8,5 14 14 25	1,38	FI-GE-06LM-W3	
.24		5800		.16 .31 .93 1.24 .33 .55 .55 18.4 3.03			
6		400	M 12 x 1,5	4 12 29 37 10 17 14 45	2,26	FI-GE-06LM12x1.5-W3	
.24		5800		.16 .47 1.14 1.46 .39 .67 .55 33.2 4.98			
6		400	M 14 x 1,5	4 12 30 38 11 19 14 70	2,89	FI-GE-06LM14x1.5-W3	
.24		5800		.16 .47 1.18 1.50 .43 .75 .55 51.6 6.35			
8		400	M 10 x 1	4 8 23,5 31,5 8,5 14 17 25	1,53	FI-GE-08LM10x1-W3	
.31		5800		.16 .31 .93 1.24 .33 .55 .67 18.4 3.37			
8		400	M 12 x 1,5	6 12 29 37 10 17 17 45	2,21	FI-GE-08LM-W3	
.31		5800		.24 .47 1.14 1.46 .39 .67 .67 33.2 4.86			
8		400	M 14 x 1,5	6 12 30 38 11 19 17 70	3,11	FI-GE-08LM14x1.5-W3	
.31		5800		.24 .47 1.18 1.50 .43 .75 .67 51.6 6.83			
8		400	M 16 x 1,5	6 12 30 38 11 22 17 90	4,05	FI-GE-08LM16x1.5-W3	
.31		5800		.24 .47 1.18 1.50 .43 .87 .67 66.4 8.91			
8		400	M 18 x 1,5	6 12 30,5 38,5 11,5 24 17 120	4,34	FI-GE-08LM18x1.5-W3	
.31		5800		.24 .47 1.20 1.52 .45 .94 .67 88.5 9.54			
8		400	M 22 x 1,5	14 14 34 40 13 27 17 170	6,46	FI-GE-08LM22x1.5-W3	
.31		5800		.55 .55 1.34 1.57 .51 1.06 .67 125.4 14.24			
10		400	M 10 x 1	4 8 25,5 33,5 1,5 17 19 25	2,20	FI-GE-10LM10x1-W3	
.39		5800		.16 .31 1.00 1.32 .41 .67 .75 18.4 4.84			
10		400	M 12 x 1,5	6 12 30 38 11 17 19 45	2,38	FI-GE-10LM12x1.5-W3	
.39		5800		.24 .47 1.18 1.50 .43 .67 .75 33.2 5.23			
10		400	M 14 x 1,5	7 12 30 38 11 19 19 70	2,94	FI-GE-10LM-W3	
.39		5800		.28 .47 1.18 1.50 .43 .75 .75 51.6 6.46			
10		400	M 16 x 1,5	8 12 31,5 39,5 12,5 22 19 90	4,05	FI-GE-10LM16x1.5-W3	
.39		5800		.31 .47 1.24 1.56 .49 .87 .75 66.4 8.91			
10		400	M 18 x 1,5	8 12 31,5 39,5 12,5 24 19 120	4,94	FI-GE-10LM18x1.5-W3	
.39		5800		.31 .47 1.24 1.56 .49 .94 .75 88.5 10.86			
10		400	M 22 x 1,5	8 14 34 42 13 27 19 170	7,36	FI-GE-10LM22x1.5-W3	
.39		5800		.31 .55 1.34 1.65 .51 1.06 .75 125.4 16.19			
12		400	M 12 x 1,5	6 12 30 38 11 19 22 45	2,84	FI-GE-12LM12x1.5-W3	
.47		5800		.24 .47 1.18 1.50 .43 .75 .87 33.2 6.25			
12		400	M 14 x 1,5	7 12 30 38 11 19 22 70	3,06	FI-GE-12LM14x1.5-W3	
.47		5800		.28 .47 1.18 1.50 .43 .75 .87 51.6 6.72			
12		400	M 16 x 1,5	9 12 31,5 39,5 12,5 22 22 90	3,92	FI-GE-12LM-W3	
.47		5800		.35 .47 1.24 1.56 .49 .87 .87 66.4 8.63			
12		400	M 18 x 1,5	10 12 31,5 39,5 12,5 24 22 120	4,90	FI-GE-12LM18x1.5-W3	
.47		5800		.39 .47 1.24 1.56 .49 .94 .87 88.5 10.78			
12		400	M 22 x 1,5	10 14 35 43 14 27 22 170	6,96	FI-GE-12LM22x1.5-W3	
.47		5800		.39 .55 1.38 1.69 .55 1.06 .87 125.4 15.31			

Torque recommendations for Steel mating material.

Male threaded studs were designed for female threaded ports in components made of steel. For applications with components made of softer mating materials (e.g. Aluminium), the use of connectors with additionally rolled male threads is recommended.  
Please contact STAUFF prior to the assembly for further information.

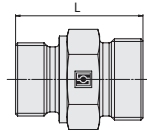
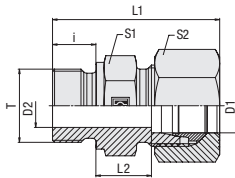

**Straight Male Stud Fitting  
Type FI-GE-...-M ▪ Series L**

**C**
**Metric Parallel Thread**
**Metallic Sealing Edge**

Series	Tube OD (mm/in)	PN (bar/PSI)	Dimensions (mm/in)										Torque (N-m/ft-lb)	Weight (kg/lbs) ca. per 100	Ordering Codes <sup>3</sup>
			Thread T	D2	i	L	L1 <sup>1</sup>	L2	S1	S2	Thread T				
L	15	400	M 16 x 1,5	9	12	32	40	13	24	27	90	5,15	FI-GE-15LM16x1.5-W3		
	.59	5800		.35	.47	1.26	1.57	.51	.94	1.06	66.4	11.33			
	15	400	M 18 x 1,5	11	12	32,5	4,5	13,5	24	27	120	5,28	FI-GE-15LM-W3		
	.59	5800		.43	.47	1.28	1.59	.53	.94	1.06	88.5	11.61			
	15	400	M 22 x 1,5	12	14	35	43	14	27	27	170	7,15	FI-GE-15LM22x1.5-W3		
	.59	5800		.47	.55	1.38	1.69	.55	1.06	1.06	125.4	15.73			
	18	400	M 18 x 1,5	11	12	33,5	42,5	14	27	32	120	6,26	FI-GE-18LM18x1.5-W3		
	.71	5800		.43	.47	1.32	1.67	.55	1.06	1.26	88.5	13.77			
	18	400	M 22 x 1,5	14	14	36	45	14,5	27	32	170	7,60	FI-GE-18LM-W3		
	.71	5800		.55	.55	1.42	1.77	.57	1.06	1.26	125.4	16.72			
	18	250	M 26 x 1,5	15	16	38	47	14,5	32	32	230	10,88	FI-GE-18LM26x1.5-W3		
	.71	3626		.59	.63	1.50	1.85	.57	1.26	1.26	169.6	23.94			
	22	250	M 22 x 1,5	14	14	38	47	16,5	32	36	170	9,10	FI-GE-22LM22x1.5-W3		
	.87	3626		.55	.55	1.50	1.85	.65	1.26	1.42	125.4	20.02			
	22	250	M 26 x 1,5	18	16	40	49	16,5	32	36	230	10,34	FI-GE-22LM-W3		
	.87	3626		.71	.63	1.57	1.93	.65	1.26	1.42	169.6	22.74			
	22	250	M 33 x 2	23	18	43	53	17,5	41	36	400	16,15	FI-GE-22LM33x2-W3		
	.87	3626		.91	.71	1.69	2.09	.69	1.61	1.42	295	35.60			
	28	250	M 26 x 1,5	18	16	41	51	17,5	41	41	230	14,46	FI-GE-28LM26x1.5-W3		
	1.10	3626		.71	.63	1.61	2.01	.69	1.61	1.61	169.6	31.88			
	28	250	M 33 x 2	23	18	43	52	17,5	41	41	400	17,13	FI-GE-28LM-W3		
	1.10	3626		.91	.71	1.69	2.05	.69	1.61	1.61	295	37.69			
	35	200	M 42 x 2	30	20	48	59	17,5	50	50	700	27,85	FI-GE-35LM-W3		
	1.38	2900		1.18	.79	1.89	2.32	.69	1.97	1.97	516.3	61.27			
	42	200	M 48 x 2	36	22	52	64	19	55	60	900	35,91	FI-GE-42LM-W3		
	1,65	2900		1.42	.87	2.05	2.52	.75	2.17	2.36	663.8	79.00			

**Ordering Codes**
**\*FI-GE\*-10\*L\*M\*-W3\*-MS**

* Straight Male Stud Fitting	FI-GE
* Outside Tube Diameter D1 (in mm)	-10
* Series	Extra-Light Series (page 44) <b>LL</b> Light Series (pages 44/45) <b>L</b> Heavy Series (page 46) <b>S</b>
* Thread Type	Metric Parallel Thread <b>M</b>
If required, please indicate special sizes, e.g. M12x1.5!	
* Material Code	Steel, zinc/nickel-plated <b>-W3</b>
Please contact STAUFF for alternative materials and surface finishings.	
* Assembling / Kitting	Fitting body only <b>—</b> Fitting body supplied with cutting ring and union nut <b>-MS</b> Fitting body supplied with soft-sealing cutting ring and union nut <b>-MSV</b>

**Connecting Parts**

	Cutting Ring Type <b>FI-DS</b>	Page 28
	Soft-Sealing Cutting Ring Type <b>FI-WDDS</b>	Page 29
	Support Sleeve Type <b>FI-VH</b>	Page 31
	STAUFF Form EVO Sealing Ring Type <b>FI-FD</b>	Page 32
	Union Nut Type <b>FI-M</b>	Page 33
	37° Flared Tube Fitting Set Type <b>FI-AB</b>	Page 37

<sup>1</sup> Approximate dimension in assembled condition.

<sup>2</sup> Weight excluding cutting ring and union nut.

<sup>3</sup> Standard scope of delivery: Fitting body only.

Male stud acc. to DIN 3852-1 (Form B) / ISO 9974-3 (Type B)  
Port acc. to DIN 3852-1 (Form X) / ISO 9974-1

Torque recommendations for Steel mating material.

Male threaded studs were designed for female threaded ports in components made of steel. For applications with components made of softer mating materials (e.g. Aluminium), the use of connectors with additionally rolled male threads is recommended.

Please contact STAUFF prior to the assembly for further information.



**Straight Male Stud Fitting**  
Type FI-GE-...-M ▪ Series S

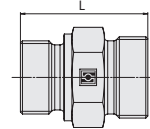
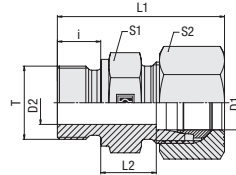

C

**Ordering Codes**

**\*FI-GE\*-10\*S\*M\*-W3\*-MS**

- \* Straight Male Stud Fitting **FI-GE**
- \* Outside Tube Diameter D1 (in mm) **-10**
- \* Series **LL**  
 Extra-Light Series (page 44)  
**L** Light Series (pages 44/45)  
**S** Heavy Series (page 46)
- \* Thread Type **M**  
 Metric Parallel Thread
- If required, please indicate special sizes, e.g. M12x1.5!
- \* Material Code **-W3**  
 Steel, zinc/nickel-plated
- Please contact STAUFF for alternative materials and surface finishings.
- \* Assembling / Kitting **—**  
 Fitting body only
- Fitting body supplied with cutting ring and union nut **-MS**
- Fitting body supplied with soft-sealing cutting ring and union nut **-MSV**

**Connecting Parts**

- Cutting Ring  
Type **FI-DS** Page 28
- Soft-Sealing Cutting Ring  
Type **FI-WDDS** Page 29
- Support Sleeve  
Type **FI-VH** Page 31
- STAUFF Form EVO Sealing Ring  
Type **FI-FD** Page 32
- Union Nut  
Type **FI-M** Page 33
- 37° Flared Tube Fitting Set  
Type **FI-AB** Page 37

**Metallic Sealing Edge**

**Metric Parallel Thread**

Series	Tube OD		PN	Dimensions								Torque ( <sup>N·m</sup> /ft-lb)	Weight ( <sup>kg</sup> /lbs) ca.	Ordering Codes <sup>3</sup>
	(mm/in)	(mm/in)		Thread	T	D2	i	L	L1 <sup>1</sup>	L2	S1			
S	6	630	9135	M 12 x 1,5	4	12	32	40	13	17	17	60	2,99	FI-GE-06SM-W3
	.24				.16	.47	1.26	1.57	.51	.67	.67	44.2	6.58	
	8	630	9135	M 14 x 1,5	5	12	34	42	15	19	19	80	4,26	FI-GE-08SM-W3
	.31				.20	.47	1.34	1.65	.59	.75	.75	59	9.37	
	10	630	9135	M 14 x 1,5	5	12	34,5	42	15	19	22	80	4,63	FI-GE-10SM14x1.5-W3
	.39				.2	.47	1.36	1.65	.59	.75	.87	59	10.21	
	10	630	9135	M 16 x 1,5	7	12	34,5	43,5	15	22	22	130	5,46	FI-GE-10SM-W3
	.39				.28	.47	1.36	1.71	.59	.87	.87	95.9	12.01	
	10	630	9135	M 18 x 1,5	7	12	36,5	45,5	17	24	22	190	7,66	FI-GE-10SM18x1.5-W3
	.39				.28	.47	1.44	1.79	.67	.94	.87	140.1	16.85	
	10	630	9135	M 22 x 1,5	12	14	39	47	17,5	27	22	300	9,18	FI-GE-10SM22x1.5-W3
	.39				.47	.55	1.54	1.85	.69	1.06	.87	221.2	20.24	
	12	630	9135	M 14 x 1,5	5	12	36	45	17	22	24	80	6,00	FI-GE-12SM14x1.5-W3
	.47				.20	.47	1.42	1.77	.67	.87	.94	59	13.20	
	12	630	9135	M 16 x 1,5	7	12	24,5	48	17	22	24	130	6,12	FI-GE-12SM16x1.5-W3
	.47				.28	.47	.96	1.89	.67	.87	.94	95.9	13.47	
	12	630	9135	M 18 x 1,5	8	12	36,5	45,5	17	24	24	190	7,19	FI-GE-12SM-W3
	.47				.31	.47	1.44	1.79	.67	.94	.94	140.1	15.83	
	12	630	9135	M 22 x 1,5	8	14	39	48	17,5	27	24	300	9,28	FI-GE-12SM22x1.5-W3
	.47				.31	.55	1.54	1.89	.69	1.06	.94	221.2	20.42	
	14	400	5800	M 18 x 1,5	8	12	39	48	19	27	27	190	9,10	FI-GE-14SM18x1.5-W3
	.55				.31	.47	1.54	1.89	.75	1.06	1.06	140.1	20.06	
	14	400	5800	M 20 x 1,5	10	14	41	51	19	27	27	220	9,49	FI-GE-14SM-W3
	.55				.39	.55	1.61	2.01	.75	1.06	1.06	162.3	20.88	
	16	400	5800	M 18 x 1,5	8	12	38,5	48,5	18	27	30	190	7,82	FI-GE-16SM18x1.5-W3
	.63				.31	.47	1.52	1.91	.71	1.06	1.18	140.1	17.20	
	16	400	5800	M 22 x 1,5	12	14	41	51	18,5	27	30	300	9,75	FI-GE-16SM-W3
	.63				.47	.55	1.61	2.01	.73	1.06	1.18	221.2	21.44	
	16	400	5800	M 27 x 2	16	16	45	55	20,5	32	30	420	14,29	FI-GE-16SM27x2-W3
	.63				.63	.63	1.77	2.17	.81	1.26	1.18	309.8	31.50	
	20	400	5800	M 18 x 1,5	8	12	42,5	54	20	32	36	190	13,64	FI-GE-20SM18x1.5-W3
	.79				.31	.47	1.67	2.13	.79	1.26	1.42	140.1	30.07	
	20	400	5800	M 22 x 1,5	12	14	47	58	22,5	32	36	300	13,95	FI-GE-20SM22x1.5-W3
	.79				.47	.55	1.85	2.28	.89	1.26	1.42	221.2	30.69	
	20	400	5800	M 27 x 2	16	16	47	58	20,5	32	36	420	15,12	FI-GE-20SM-W3
	.79				.63	.63	1.85	2.28	.81	1.26	1.42	309.8	33.22	
	25	400	5800	M 33 x 2	20	18	53	65	23	41	46	600	26,71	FI-GE-25SM-W3
	.98				.79	.71	2.09	2.56	.91	1.61	1.81	442.5	58.77	
	30	200	2900	M 42 x 2	25	20	57	70	23,5	50	50	700	42,96	FI-GE-30SM-W3
	1.18				.98	.79	2.24	2.76	.93	1.97	1.97	516.3	94.51	
	38	200	2900	M 48 x 2	32	22	64	79	26	55	60	950	56,40	FI-GE-38SM-W3
	1.50				1.26	.87	2.52	3.11	1.02	2.17	2.36	700.7	124.08	

<sup>1</sup> Approximate dimension in assembled condition.

<sup>2</sup> Weight excluding cutting ring and union nut.

<sup>3</sup> Standard scope of delivery: Fitting body only.

Male stud acc. to DIN 3852-1 (Form B) / ISO 9974-3 (Type B)  
 Port acc. to DIN 3852-1 (Form X) / ISO 9974-1

Torque recommendations for Steel mating material.

Male threaded studs were designed for female threaded ports in components made of steel. For applications with components made of softer mating materials (e.g. Aluminium), the use of connectors with additionally rolled male threads is recommended.

Please contact STAUFF prior to the assembly for further information.



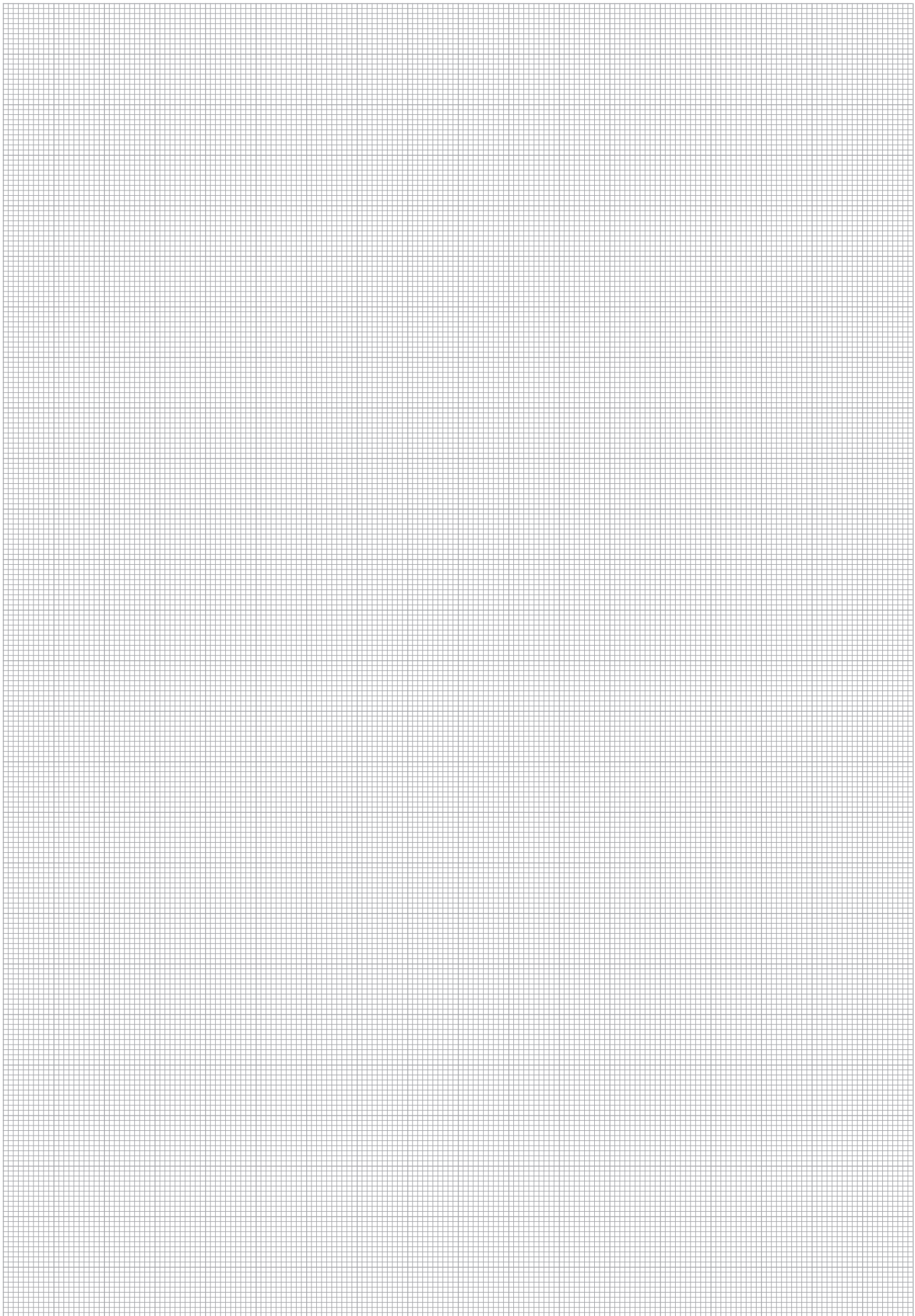

**Straight Male Stud Fitting**  
Type FI-GE-...-R-WD ▪ Series LL / L

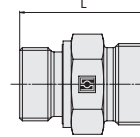
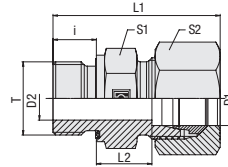

C

**Ordering Codes**

**\*FI-GE\*-10\*L\*R\*-WD\*-B\*-W3\*-MS**

- \* Straight Male Stud Fitting **FI-GE**
- \* Outside Tube Diameter D1 (in mm) **-10**
- \* Series                   Extra-Light Series (page 48) **LL**  
                              Light Series (pages 48/49) **L**  
                              Heavy Series (pages 50/51) **S**
- \* Thread Type           Whitworth Parallel Pipe Thread (BSPP) **R**
- If required, please indicate special sizes, e.g. R1/8!
- \* Seal Type             Profile Sealing Ring **-WD**
- \* Seal Material        NBR (Buna-N®) **-B**  
                              FKM (Viton®) **-V**  
                              EPDM **-E**
- \* Material Code       Steel, zinc/nickel-plated **-W3**
- Please contact STAUFF for alternative materials and surface finishings.
- \* Assembling / Kitting   Fitting body only **—**
- Fitting body supplied with cutting ring and union nut **-MS**
- Fitting body supplied with soft-sealing cutting ring and union nut **-MSV**

**Connecting Parts**

-  Cutting Ring  
Type **FI-DS** Page 28
-  Soft-Sealing Cutting Ring  
Type **FI-WDDS** Page 29
-  Support Sleeve  
Type **FI-VH** Page 31
-  STAUFF Form EVO Sealing Ring  
Type **FI-FD** Page 32
-  Union Nut  
Type **FI-M** Page 33
-  37° Flared Tube Fitting Set  
Type **FI-AB** Page 37

**Spare Parts / Accessories**

-  Profile Sealing Ring  
Type **WDG** Page 238

**Whitworth Parallel Pipe Thread (BSPP)**

**Profile Sealing Ring**

Series	Tube OD		PN (bar/psi)	Dimensions (mm/in)									Torque (Nm/lb-ft)	Weight (kg/lbs) ca.	Ordering Codes <sup>3</sup>
	D1	D2		Thread	T	D2	i	L	L1 <sup>1</sup>	L2	S1	S2			
LL	6	100	100	G 1/8	4	8	21,5	28	8	14	12	18	1,14	FI-GE-06LLR-WD-B-W3	
	.24	1450			.16	.31	.85	1.10	.31	.55	.47	13.3	2.51		
L	6	500	500	G 1/8	4	8	23,5	31,5	8,5	14	14	18	1,33	FI-GE-06LR-WD-B-W3	
	.24	7250			.16	.31	.93	1.24	.33	.55	.55	13.3	2.93		
	6	500	500	G 1/4	4	12	29	37	10	19	14	35	2,74	FI-GE-06LR1/4-WD-B-W3	
	.24	7250			.16	.47	1.14	1.46	.39	.75	.55	25.9	6.04		
	6	400	400	G 3/8	4	12	30,5	38,5	11,5	22	14	70	4,03	FI-GE-06LR3/8-WD-B-W3	
	.24	5800			.16	.47	1.20	1.52	.45	.87	.55	51.8	8.87		
	6	400	400	G 1/2	4	14	33	41	12	27	14	90	6,37	FI-GE-06LR1/2-WD-B-W3	
	.24	5800			.16	.55	1.30	1.61	.47	1.06	.55	66.6	14.01		
	8	500	500	G 1/8	4	8	24,5	32,5	9,5	14	17	18	1,61	FI-GE-08LR1/8-WD-B-W3	
	.31	7250			.16	.31	.96	1.28	.37	.55	.67	13.3	3.53		
	8	500	500	G 1/4	6	12	29	37	10	19	17	35	2,65	FI-GE-08LR-WD-B-W3	
	.31	7250			.24	.47	1.14	1.46	.39	.75	.67	25.9	5.83		
	8	400	400	G 3/8	6	12	30,5	38,5	11,5	22	17	70	4,35	FI-GE-08LR3/8-WD-B-W3	
	.31	5800			.24	.47	1.20	1.52	.45	.87	.67	51.8	9.57		
	8	400	400	G 1/2	6	14	33	41	12	27	17	90	6,58	FI-GE-08LR1/2-WD-B-W3	
	.31	5800			.24	.55	1.30	1.61	.47	1.06	.67	66.6	14.48		
	10	500	500	G 1/8	4	8	25,5	33,5	10,5	17	19	18	2,05	FI-GE-10LR1/8-WD-B-W3	
	.39	7250			.16	.31	1.00	1.32	.41	.67	.75	13.3	4.52		
	10	500	500	G 1/4	6	12	30	38	11	19	19	35	2,88	FI-GE-10LR-WD-B-W3	
	.39	7250			.24	.47	1.18	1.50	.43	.75	.75	25.9	6.34		
	10	500	500	G 3/8	8	12	31,5	39,5	12,5	22	19	70	4,15	FI-GE-10LR3/8-WD-B-W3	
	.39	7250			.31	.47	1.24	1.56	.49	.87	.75	51.8	9.12		
	10	400	400	G 1/2	8	14	34	42	13	27	19	90	7,10	FI-GE-10LR1/2-WD-B-W3	
	.39	5800			.31	.55	1.34	1.65	.51	1.06	.75	66.6	15.61		
	12	400	400	G 1/8	4	8	26,5	34,5	11,5	19	22	18	2,55	FI-GE-12LR1/8-WD-B-W3	
	.47	5800			.16	.31	1.04	1.36	.45	.75	.87	13.3	5.61		
	12	400	400	G 1/4	6	12	31	39	12	19	22	35	3,05	FI-GE-12LR1/4-WD-B-W3	
	.47	5800			.24	.47	1.22	1.54	.47	.75	.87	25.9	6.70		
	12	400	400	G 3/8	9	12	31,5	39,5	12,5	22	22	70	4,14	FI-GE-12LR-WD-B-W3	
	.47	5800			.35	.47	1.24	1.56	.49	.87	.87	51.8	9.10		
	12	400	400	G 1/2	10	14	34	42	13	27	22	90	6,65	FI-GE-12LR1/2-WD-B-W3	
	.47	5800			.39	.55	1.34	1.65	.51	1.06	.87	66.6	14.63		
	12	250	250	G 3/4	10	16	37	45	14	32	22	180	9,25	FI-GE-12LR3/4-WD-B-W3	
	.47	3625			.39	.63	1.46	1.77	.55	1.26	.87	133.2	20.34		
	15	400	400	G 1/4	7	12	31,5	39,5	12,5	22	27	35	4,07	FI-GE-15LR1/4-WD-B-W3	
	.59	5800			.28	.47	1.24	1.56	.49	.87	1.06	25.9	8.95		
	15	400	400	G 3/8	9	12	32,5	40,5	13,5	24	27	70	5,32	FI-GE-15LR3/8-WD-B-W3	
	.59	5800			.35	.47	1.28	1.59	.53	.94	1.06	51.8	11.70		
	15	400	400	G 1/2	12	14	35	43	14	27	27	90	6,62	FI-GE-15LR-WD-B-W3	
	.59	5800			.47	.55	1.38	1.69	.55	1.06	1.06	66.6	14.56		
	15	250	250	G 3/4	12	16	38	46	15	32	27	180	11,80	FI-GE-15LR3/4-WD-B-W3	
	.59	3625			.47	.63	1.50	1.81	.59	1.26	1.06	133.2	25.96		
	15	250	250	G 1	12	18	42,5	49	17,5	41	27	310	22,61	FI-GE-15LR1-WD-B-W3	
	.59	3625			.47	.71	1.67	1.93	.69	1.61	1.06	229.4	49.85		

<sup>1</sup> Approximate dimension in assembled condition.

<sup>2</sup> Weight excluding cutting ring and union nut.

<sup>3</sup> Standard scope of delivery: Fitting body only.

Male stud acc. to ISO 1179-2 (Type E)

Port acc. to ISO 1179-1

Torque recommendations for Steel mating material.

Standard seal material is NBR (Buna-N®).

Male threaded studs were designed for female threaded ports in components made of steel. For applications with components made of softer mating materials (e.g. Aluminium), the use of connectors with additionally rolled male threads is recommended.

Please contact STAUFF prior to the assembly for further information.





Straight Male Stud Fitting  
Type FI-GE-...-R-WD • Series L

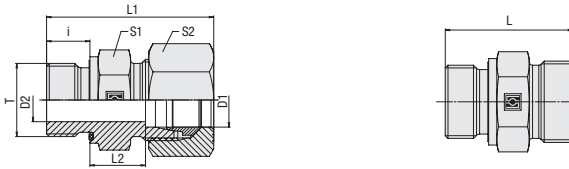

C

Profile Sealing Ring

Whitworth Parallel Pipe Thread (BSPP)

Series	Tube OD (mm/in)	PN (bar/PSI)	Dimensions (mm/in)										Torque (N•m/ft•lb)	Weight (kg/lbs) Ca. per 100	Ordering Codes <sup>3</sup>
			Thread	T	D2	i	L	L <sup>1</sup>	L2	S1	S2	Thread T			
L	18	400	G 3/8	9	12	33,5	42,5	14	27	32	70	6,56	FI-GE-18LR3/8-WD-B-W3		
	.71	5800		.35	.47	1.32	1.67	.55	1.06	1.26	51.8	14.44			
	18	400	G 1/2	14	14	36	45	14,5	27	32	90	7,01	FI-GE-18LR-WD-B-W3		
	.71	5800		.55	.55	1.42	1.77	.57	1.06	1.26	66.6	15.41			
	18	400	G 3/4	15	16	38	47	14,5	32	32	180	10,89	FI-GE-18LR3/4-WD-B-W3		
	.71	5800		.59	.63	1.50	1.85	.57	1.26	1.26	133.2	23.96			
	18	250	G 1	22	18	43	48	17,5	41	32	310	18,44	FI-GE-18LR1-WD-B-W3		
	.71	3625		.87	.71	1.69	1.89	.69	1.61	1.26	229.4	40.65			
	22	250	G 1/2	14	14	38	47	16,5	32	36	90	8,75	FI-GE-22LR1/2-WD-B-W3		
	.87	3625		.55	.55	1.50	1.85	.65	1.26	1.42	66.6	19.25			
	22	250	G 3/4	18	16	40	49	16,5	32	36	180	10,28	FI-GE-22LR-WD-B-W3		
	.87	3625		.71	.63	1.57	1.93	.65	1.26	1.42	133.2	22.61			
	22	250	G 1	19	18	43	52	17,5	41	36	310	18,57	FI-GE-22LR1-WD-B-W3		
	.87	3625		.75	.71	1.69	2.05	.69	1.61	1.42	229.4	40.85			
	22	250	G 1 1/4	30	20	46	55	18,5	50	36	450	26,41	FI-GE-22LR1-1/4-WD-B-W3		
	.87	3625		1.18	.79	1.81	2.17	.73	1.97	1.42	333	58.22			
	28	250	G 3/4	18	16	41	50	17,5	41	41	180	14,97	FI-GE-28LR3/4-WD-B-W3		
	1.10	3625		.71	.63	1.61	1.97	.69	1.61	1.61	133.2	32.93			
	28	250	G 1	23	18	43	52	17,5	41	41	310	15,83	FI-GE-28LR-WD-B-W3		
	1.10	3625		.91	.71	1.69	2.05	.69	1.61	1.61	229.4	34.82			
	28	250	G 1 1/4	24	20	45	54	17,5	50	41	450	13,40	FI-GE-28LR1-1/4-WD-B-W3		
	1.10	3625		.94	.79	1.77	2.13	.69	1.97	1.61	333.0	29.48			
	35	250	G 3/4	18	16	44	55	17	46	50	180	20,71	FI-GE-35LR3/4-WD-B-W3		
	1.38	3625		.71	.63	1.73	2.17	.67	1.81	1.97	133.2	45.56			
	35	250	G 1	23	18	46	57	17,5	46	50	310	22,15	FI-GE-35LR1-WD-B-W3		
	1.38	3625		.91	.71	1.81	2.24	.69	1.81	1.97	229.4	48.74			
	35	250	G 1 1/4	30	20	48	59	17,5	50	50	450	27,23	FI-GE-35LR-WD-B-W3		
	1.38	3625		1.18	.79	1.89	2.32	.69	1.97	1.97	333.0	59.90			
	35	250	G 1 1/2	30	22	52	63	19,5	55	50	540	42,18	FI-GE-35LR1-1/2-WD-B-W3		
	1.38	3625		1.18	.87	2.05	2.48	.77	2.17	1.97	399.6	92.80			
	42	250	G 1	23	18	48	60	19	55	60	310	31,72	FI-GE-42LR1-WD-B-W3		
	1.65	3625		.91	.71	1.89	2.36	.75	2.17	2.36	229.4	69.78			
	42	250	G 1 1/4	30	20	50	62	19	55	60	450	34,03	FI-GE-42LR1-1/4-WD-B-W3		
	1.65	3625		1.18	.79	1.97	2.44	.75	2.17	2.36	333.0	74.87			
	42	250	G 1 1/2	36	22	52	64	19	55	60	540	34,37	FI-GE-42LR-WD-B-W3		
	1.65	3625		1.42	.87	2.05	2.52	.75	2.17	2.36	399.6	75.62			

<sup>1</sup> Approximate dimension in assembled condition.

<sup>2</sup> Weight excluding cutting ring and union nut.

<sup>3</sup> Standard scope of delivery: Fitting body only.

Male stud acc. to ISO 1179-2 (Type E)

Port acc. to ISO 1179-1

Torque recommendations for Steel mating material.

Standard seal material is NBR (Buna-N®).

Male threaded studs were designed for female threaded ports in components made of steel. For applications with components made of softer mating materials (e.g. Aluminium), the use of connectors with additionally rolled male threads is recommended.

Please contact STAUFF prior to the assembly for further information.

Ordering Codes

\*FI-GE\*-10\*L\*R\*-WD\*-B\*-W3\*-MS

- \* Straight Male Stud Fitting FI-GE
- \* Outside Tube Diameter D1 (in mm) -10
- \* Series LL  
L  
S  
Extra-Light Series (page 48)  
Light Series (pages 48/49)  
Heavy Series (pages 50/51)
- \* Thread Type R  
Whitworth Parallel  
Pipe Thread (BSPP)
- If required, please indicate special sizes, e.g. R1/8!
- \* Seal Type -WD  
Profile Sealing Ring
- \* Seal Material -B  
-V  
-E  
NBR (Buna-N®)  
FKM (Viton®)  
EPDM
- \* Material Code -W3  
Steel, zinc/nickel-plated
- Please contact STAUFF for alternative materials and surface finishings.
- \* Assembling / Kitting —  
Fitting body only  
Fitting body supplied with cutting ring and union nut -MS  
Fitting body supplied with soft-sealing cutting ring and union nut -MSV

Connecting Parts

-  Cutting Ring  
Type FI-DS Page 28
-  Soft-Sealing Cutting Ring  
Type FI-WDDS Page 29
-  Support Sleeve  
Type FI-VH Page 31
-  STAUFF Form EVO Sealing Ring  
Type FI-FD Page 32
-  Union Nut  
Type FI-M Page 33
-  37° Flared Tube Fitting Set  
Type FI-AB Page 37

Spare Parts / Accessories

-  Profile Sealing Ring  
Type WDG Page 238



**Straight Male Stud Fitting**  
Type FI-GE-...-R-WD ■ Series S

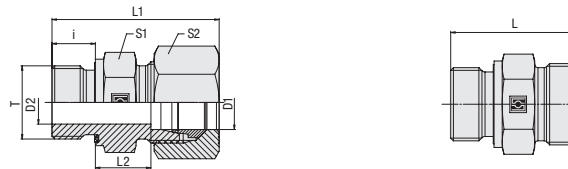

C

**Whitworth Parallel Pipe Thread (BSPP)**

**Profile Sealing Ring**

**Ordering Codes**

**\*FI-GE\*-10\*S\*R\*-WD\*-B\*-W3\*-MS**

- \* Straight Male Stud Fitting **FI-GE**
- \* Outside Tube Diameter D1 (in mm) **-10**
- \* Series           Extra-Light Series (page 48) **LL**  
                  Light Series (pages 48/49) **L**  
                  Heavy Series (pages 50/51) **S**
- \* Thread Type     Whitworth Parallel Pipe Thread (BSPP) **R**
- If required, please indicate special sizes, e.g. R1/8!
- \* Seal Type       Profile Sealing Ring **-WD**
- \* Seal Material    NBR (Buna-N®) **-B**  
                  FKM (Viton®) **-V**  
                  EPDM **-E**
- \* Material Code   Steel, zinc/nickel-plated **-W3**
- Please contact STAUFF for alternative materials and surface finishings.
- \* Assembling / Kitting   Fitting body only **—**  
                                  Fitting body supplied with cutting ring and union nut **-MS**  
                                  Fitting body supplied with soft-sealing cutting ring and union nut **-MSV**

**Connecting Parts**

-  Cutting Ring  
Type **FI-DS**                   Page 28
-  Soft-Sealing Cutting Ring  
Type **FI-WDDS**               Page 29
-  Support Sleeve  
Type **FI-VH**                   Page 31
-  STAUFF Form EVO Sealing Ring  
Type **FI-FD**                   Page 32
-  Union Nut  
Type **FI-M**                    Page 33
-  37° Flared Tube Fitting Set  
Type **FI-AB**                   Page 37

**Spare Parts / Accessories**

-  Profile Sealing Ring  
Type **WDG**                   Page 238

Series	Tube OD (mm/in)	PN (bar/psi)	Dimensions (mm/in)										Torque (N-m/lb-ft)	Weight (kg/lbs) ca.	Ordering Codes <sup>3</sup>
			D1	Thread	T	D2	i	L	L1 <sup>1</sup>	L2	S1	S2			
S	6	800	G 1/8	4	8	27,5	35,5	12,5	14	17	25	2,49	FI-GE-06SR1/8-WD-B-W3		
	.24	11600		.16	.31	1.08	1.40	.49	.55	.67	18.5	5.48			
	6	800	G 1/4	4	12	32	40	13	19	17	55	3,46	FI-GE-06SR-WD-B-W3		
	.24	11600		.16	.47	1.26	1.57	.51	.75	.67	40.7	7.61			
	6	800	G 3/8	4	12	34,5	42,5	15,5	22	17	80	5,63	FI-GE-06SR3/8-WD-B-W3		
	.24	11600		.16	.47	1.36	1.67	.61	.87	.67	59.2	12.38			
	6	800	G 1/2	4	14	39	47	18	27	17	115	8,22	FI-GE-06SR1/2-WD-B-W3		
	.24	11600		.16	.55	1.54	1.85	.71	1.06	.67	85.1	18.09			
	8	800	G 1/8	4	8	29,5	37,5	14,5	19	19	25	3,41	FI-GE-08SR1/8-WD-B-W3		
	.31	11600		.16	.31	1.16	1.48	.57	.75	.75	18.5	7.49			
	8	800	G 1/4	5	12	34	42	15	19	19	55	4,00	FI-GE-08SR-WD-B-W3		
	.31	11600		.20	.47	1.34	1.65	.59	.75	.75	40.7	8.80			
	8	800	G 3/8	5	12	34,5	42,5	15,5	22	19	80	5,72	FI-GE-08SR3/8-WD-B-W3		
	.31	11600		.20	.47	1.36	1.67	.61	.87	.75	59.2	12.58			
	8	800	G 1/2	5	14	39	47	18	27	19	115	9,92	FI-GE-08SR1/2-WD-B-W3		
	.31	11600		.20	.55	1.54	1.85	.71	1.06	.75	85.1	21.82			
	10	800	G 1/4	5	12	34	43	14,5	19	22	55	4,22	FI-GE-10SR1/4-WD-B-W3		
	.39	11600		.20	.47	1.34	1.69	.57	.75	.87	40.7	9.28			
	10	800	G 3/8	7	12	34,5	43,5	15	22	22	80	5,60	FI-GE-10SR-WD-B-W3		
	.39	11600		.28	.47	1.36	1.71	.59	.87	.87	59.2	12.31			
	10	800	G 1/2	7	14	39	47	17,5	27	22	115	9,57	FI-GE-10SR1/2-WD-B-W3		
	.39	11600		.28	.55	1.54	1.85	.69	1.06	.87	85.1	21.06			
	12	630	G 1/4	5	12	36	44	16,5	22	24	55	5,60	FI-GE-12SR1/4-WD-B-W3		
	.47	9135		.20	.47	1.42	1.73	.65	.87	.94	40.7	12.32			
	12	630	G 3/8	8	12	36,5	45	17	22	24	80	6,25	FI-GE-12SR-WD-B-W3		
	.47	9135		.31	.47	1.44	1.77	.67	.87	.94	59.2	13.75			
	12	630	G 1/2	8	14	39	48	17,5	27	24	115	9,52	FI-GE-12SR1/2-WD-B-W3		
	.47	9135		.31	.55	1.54	1.89	.69	1.06	.94	85.1	20.95			
	12	630	G 3/4	8	16	41	50	17,5	32	24	180	12,83	FI-GE-12SR3/4-WD-B-W3		
	.47	9135		.31	.63	1.61	1.97	.69	1.26	.94	133.2	28.22			
	14	630	G 3/8	8	12	38,5	48,5	18,5	24	27	80	5,03	FI-GE-14SR3/8-WD-B-W3		
	.55	9135		.31	.47	1.52	1.91	.73	.94	1.06	59.2	11.07			
	14	630	G 1/2	10	14	41	51	19	27	27	115	9,67	FI-GE-14SR-WD-B-W3		
	.55	9135		.39	.55	1.61	2.01	.75	1.06	1.06	85.1	21.27			
	14	630	G 3/4	10	16	45	55	21	32	27	180	14,90	FI-GE-14SR3/4-WD-B-W3		
	.55	9135		.39	.63	1.77	2.17	.83	1.26	1.06	133.2	32.78			
	16	630	G 1/4	7	12	38	48	17,5	27	30	55	8,12	FI-GE-16SR1/4-WD-B-W3		
	.63	9135		.28	.47	1.50	1.89	.69	1.06	1.18	40.7	17.86			
	16	630	G 3/8	8	12	38,5	48,5	18	27	30	80	7,53	FI-GE-16SR3/8-WD-B-W3		
	.63	9135		.31	.47	1.52	1.91	.71	1.06	1.18	59.2	16.57			
	16	630	G 1/2	12	14	41	51	18,5	27	30	115	9,08	FI-GE-16SR-WD-B-W3		
	.63	9135		.47	.55	1.61	2.01	.73	1.06	1.18	85.1	19.98			
	16	630	G 3/4	12	16	45	55	20,5	32	30	180	15,51	FI-GE-16SR3/4-WD-B-W3		
	.63	9135		.47	.63	1.77	2.17	.81	1.26	1.18	133.2	34.13			
	16	420	G 1	12	18	49	59	22,5	41	30	310	25,20	FI-GE-16SR1-WD-B-W3		
	.63	6091		.47	.71	1.93	2.32	.89	1.61	1.18	229.4	55.43			

<sup>1</sup> Approximate dimension in assembled condition.

<sup>2</sup> Weight excluding cutting ring and union nut.

<sup>3</sup> Standard scope of delivery: Fitting body only.

Male stud acc. to ISO 1179-2 (Type E)

Port acc. to ISO 1179-1

Torque recommendations for Steel mating material.

Standard seal material is NBR (Buna-N®).

Male threaded studs were designed for female threaded ports in components made of steel. For applications with components made of softer mating materials (e.g. Aluminium), the use of connectors with additionally rolled male threads is recommended.

Please contact STAUFF prior to the assembly for further information.



Straight Male Stud Fitting  
Type FI-GE-...-R-WD ▪ Series S

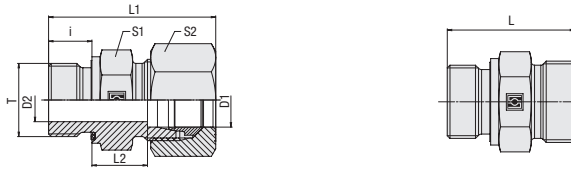

C

Profile Sealing Ring

Whitworth Parallel Pipe Thread (BSPP)

Series	Tube OD (mm/in)	PN (bar/PSI)	Dimensions (mm/in)										Torque (N·m/ft·lb)	Weight (kg/lbs) Ca.	Ordering Codes <sup>3</sup>
			Thread	T	D2	i	L	L <sup>1</sup>	L2	S1	S2	Thread T			
S	20	420	G 1/2	12	14	45	56	20,5	32	36	115	13,76	FI-GE-20SR1/2-WD-B-W3		
	.79	6091		.47	.55	1.77	2.20	.81	1.26	1.42	85.1	30.28			
	20	420	G 3/4	16	16	47	58	20,5	32	36	180	14,86	FI-GE-20SR-WD-B-W3		
	.79	6091		.63	.63	1.85	2.28	.81	1.26	1.42	133.2	32.70			
	20	420	G 1	16	18	51	62	22,5	41	36	310	21,90	FI-GE-20SR1-WD-B-W3		
	.79	6091		.63	.71	2.01	2.44	.89	1.61	1.42	229.4	48.19			
	20	420	G 1 1/4	16	20	53	64	22,5	50	36	450	13,50	FI-GE-20SR1-1/4-WD-B-W3		
	.79	6091		.63	.79	2.09	2.52	.89	1.97	1.42	333.0	29.70			
	25	400	G 1/2	12	14	49	61	23	41	46	115	23,49	FI-GE-25SR1/2-WD-B-W3		
	.98	5800		.47	.55	1.93	2.40	.91	1.61	1.81	85.1	51.68			
	25	420	G 3/4	16	16	51	63	23	41	46	180	20,33	FI-GE-25SR3/4-WD-B-W3		
	.98	6091		.63	.63	2.01	2.48	.91	1.61	1.81	133.2	44.73			
	25	420	G 1	20	18	53	65	23	41	46	310	26,75	FI-GE-25SR-WD-B-W3		
	.98	6091		.79	.71	2.09	2.56	.91	1.61	1.81	229.4	58.84			
	25	420	G 1 1/4	20	20	55	67	23	50	46	450	23,28	FI-GE-25SR1-1/4-WD-B-W3		
	.98	6091		.79	.79	2.17	2.64	.91	1.97	1.81	333.0	51.22			
	25	420	G 1 1/2	32	22	60	73,5	26	55	46	540	54,35	FI-GE-25SR1-1/2-WD-B-W3		
	.98	6091		1.26	.87	2.36	2.89	1.02	2.17	1.81	399.6	119.82			
	30	420	G 3/4	16	16	53	66	23,5	46	50	180	31,16	FI-GE-30SR3/4-WD-B-W3		
	1.18	6091		.63	.63	2.09	2.60	.93	1.81	1.97	133.2	68.56			
	30	420	G 1	20	18	55	68	23,5	46	50	310	33,20	FI-GE-30SR1-WD-B-W3		
	1.18	6091		.79	.71	2.17	2.68	.93	1.81	1.97	229.4	73.04			
	30	420	G 1 1/4	25	20	57	70	23,5	50	50	450	41,74	FI-GE-30SR-WD-B-W3		
	1.18	6091		.98	.79	2.24	2.76	.93	1.97	1.97	333.0	91.82			
30	315	G 1 1/2	25	22	62	75	26,5	55	50	540	54,30	FI-GE-30SR1-1/2-WD-B-W3			
1.18	4568		.98	.87	2.44	2.95	1.04	2.17	1.97	399.6	119.46				
38	420	G 3/4	16	16	58	73	26	55	60	180	50,1	FI-GE-38SR3/4-WD-B-W3			
1.50	6091		.63	.63	2.28	2.87	1.02	2.17	2.36	133.2	110.45				
38	420	G 1	20	18	60	75	26	55	50	310	52,00	FI-GE-38SR1-WD-B-W3			
1.50	6091		.79	.71	2.36	2.95	1.02	2.17	1.97	229.4	114.40				
38	420	G 1 1/4	25	20	62	77	26	55	60	450	57,22	FI-GE-38SR1-1/4-WD-B-W3			
1.50	6091		.98	.79	2.44	3.03	1.02	2.17	2.36	333.0	125.88				
38	420	G 1 1/2	32	22	64	79	26	55	60	540	55,90	FI-GE-38SR-WD-B-W3			
1.50	6091		1.26	.87	2.52	3.11	1.02	2.17	2.36	399.6	122.98				

<sup>1</sup> Approximate dimension in assembled condition.

<sup>2</sup> Weight excluding cutting ring and union nut.

<sup>3</sup> Standard scope of delivery: Fitting body only.

Standard seal material is NBR (Buna-N®).

Male threaded studs were designed for female threaded ports in components made of steel. For applications with components made of softer mating materials (e.g. Aluminium), the use of connectors with additionally rolled male threads is recommended.

Please contact STAUFF prior to the assembly for further information.

Male stud acc. to ISO 1179-2 (Type E)

Port acc. to ISO 1179-1

Torque recommendations for Steel mating material.

Ordering Codes

\*FI-GE\*-10\*S\*R\*-WD\*-B\*-W3\*-MS

- \* Straight Male Stud Fitting **FI-GE**
- \* Outside Tube Diameter D1 (in mm) **-10**
- \* Series **LL** Extra-Light Series (page 48)  
**L** Light Series (pages 48/49)  
**S** Heavy Series (pages 50/51)

- \* Thread Type **R** Whitworth Parallel Pipe Thread (BSPP)

If required, please indicate special sizes, e.g. R1/8!

- \* Seal Type **-WD** Profile Sealing Ring

- \* Seal Material **-B** NBR (Buna-N®)  
**-V** FKM (Viton®)  
**-E** EPDM

- \* Material Code **-W3** Steel, zinc/nickel-plated

Please contact STAUFF for alternative materials and surface finishings.

- \* Assembling / Kitting **—** Fitting body only

- MS** Fitting body supplied with cutting ring and union nut

- MSV** Fitting body supplied with soft-sealing cutting ring and union nut

Connecting Parts

- Cutting Ring  
Type **FI-DS** Page 28
- Soft-Sealing Cutting Ring  
Type **FI-WDDS** Page 29
- Support Sleeve  
Type **FI-VH** Page 31
- STAUFF Form EVO Sealing Ring  
Type **FI-FD** Page 32
- Union Nut  
Type **FI-M** Page 33
- 37° Flared Tube Fitting Set  
Type **FI-AB** Page 37

Spare Parts / Accessories

- Profile Sealing Ring  
Type **WDG** Page 238



**Straight Male Stud Fitting**  
Type FI-GE-...-M-WD • Series L

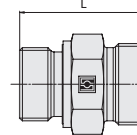
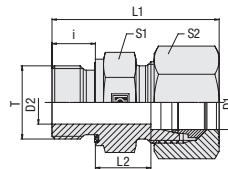

C

**Ordering Codes**

**\*FI-GE\*-10\*L\*M\*-WD\*-B\*-W3\*-MS**

- \* Straight Male Stud Fitting FI-GE
- \* Outside Tube Diameter D1 (in mm) -10
- \* Series Light Series (pages 52/53) **L**  
Heavy Series (page 54) **S**
- \* Thread Type Metric Parallel Thread **M**
- If required, please indicate special sizes, e.g. M12x1.5!
- \* Seal Type Profile Sealing Ring **-WD**
- \* Seal Material NBR (Buna-N®) **-B**  
FKM (Viton®) **-V**  
EPDM **-E**
- \* Material Code Steel, zinc/nickel-plated **-W3**
- Please contact STAUFF for alternative materials and surface finishings.
- \* Assembling / Kitting Fitting body only **—**  
Fitting body supplied with cutting ring and union nut **-MS**  
Fitting body supplied with soft-sealing cutting ring and union nut **-MSV**

**Connecting Parts**

- Cutting Ring  
Type **FI-DS** Page 28
- Soft-Sealing Cutting Ring  
Type **FI-WDDS** Page 29
- Support Sleeve  
Type **FI-VH** Page 31
- STAUFF Form EVO Sealing Ring  
Type **FI-FD** Page 32
- Union Nut  
Type **FI-M** Page 33
- 37° Flared Tube Fitting Set  
Type **FI-AB** Page 37

**Spare Parts / Accessories**

- Profile Sealing Ring  
Type **WDG** Page 238

**Metric Parallel Thread**

**Profile Sealing Ring**

Series	Tube OD (mm/in)	PN (bar/psi)	Dimensions (mm/in)										Torque (N·m/ft·lb)	Weight (kg/lbs) Ca.	Ordering Codes <sup>3</sup>
			Thread	T	D2	i	L	L1 <sup>1</sup>	L2	S1	S2	Thread T			
L	6	500	M 10 x 1	4	8	23,5	31,5	8,5	14	14	18	1,36	FI-GE-06LM-WD-B-W3		
	.24	7250		.16	.31	.93	1.24	.33	.55	.55	13.3	2.99			
	6	500	M 12 x 1,5	4	12	29	37	10	17	14	25	2,26	FI-GE-06LM12x1.5-WD-B-W3		
	.24	7250		.16	.47	1.14	1.46	.39	.67	.55	18.5	4.98			
	8	500	M 10 x 1	4	8	23,5	31,5	8,5	14	17	18	1,54	FI-GE-08LM10x1-WD-B-W3		
	.31	7250		.16	.31	.93	1.24	.33	.55	.67	13.3	3.39			
	8	500	M 12 x 1,5	6	12	29	37	10	17	17	25	2,16	FI-GE-08LM-WD-B-W3		
	.31	7250		.24	.47	1.14	1.46	.39	.67	.67	18.5	4.75			
	8	500	M 14 x 1,5	6	12	29	37	10	19	17	45	3,11	FI-GE-08LM14x1.5-WD-B-W3		
	.31	7250		.24	.47	1.14	1.46	.39	.75	.67	33.3	6.83			
	8	400	M 16 x 1,5	6	12	30	38	11	22	17	55	4,05	FI-GE-08LM16x1.5-WD-B-W3		
	.31	5800		.24	.47	1.18	1.50	.43	.87	.67	40.7	8.91			
	8	400	M 18 x 1,5	11	12	30,5	37	11,5	24	17	90	4,34	FI-GE-08LM18x1.5-WD-B-W3		
	.31	5800		.43	.47	1.20	1.46	.45	.94	.67	66.6	9.57			
	8	400	M 22 x 1,5	14	14	34	41	13	27	17	125	7,66	FI-GE-08LM22x1.5-WD-B-W3		
	.31	5800		.55	.55	1.34	1.61	.51	1.06	.67	92.5	16.89			
	10	500	M 10 x 1	4	8	25,5	33	10,5	17	19	18	2,14	FI-GE-10LM10x1-WD-B-W3		
	.39	7250		.16	.31	1.00	1.30	.41	.67	.75	13.3	4.72			
	10	500	M 12 x 1,5	6	12	30	38	11	17	19	25	2,38	FI-GE-10LM12x1.5-WD-B-W3		
	.39	7251		.24	.47	1.18	1.50	.43	.67	.75	18.5	5.23			
	10	500	M 14 x 1,5	7	12	30	38	11	19	19	45	2,88	FI-GE-10LM-WD-B-W3		
	.39	7251		.28	.47	1.18	1.50	.43	.75	.75	33.3	6.33			
	10	500	M 16 x 1,5	8	12	31,5	39,5	12,5	22	19	55	4,05	FI-GE-10LM16x1.5-WD-B-W3		
	.39	7251		.31	.47	1.24	1.56	.49	.87	.75	40.7	8.91			
	10	500	M 18 x 1,5	8	12	31,5	39,5	12,5	24	19	90	4,94	FI-GE-10LM18x1.5-WD-B-W3		
	.39	7251		.31	.47	1.24	1.56	.49	.94	.75	66.6	10.86			
	10	400	M 22 x 1,5	8	14	34	42	13	27	19	125	7,36	FI-GE-10LM22x1.5-WD-B-W3		
	.39	5800		.31	.55	1.34	1.65	.51	1.06	.75	92.5	16.19			
	12	400	M 10 x 1	4	8	25,5	33	10,5	17	19	18	2,38	FI-GE-12LM10x1-WD-B-W3		
	.47	5800		.16	.31	1.00	1.30	.41	.67	.75	13.3	5.25			
	12	400	M 12 x 1,5	4	12	32	40	11	19	22	25	2,84	FI-GE-12LM12x1.5-WD-B-W3		
	.47	5800		.16	.47	1.26	1.57	.43	.75	.87	18.5	6.25			
	12	400	M 14 x 1,5	7	12	30	38	11	19	22	45	3,06	FI-GE-12LM14x1.5-WD-B-W3		
	.47	5800		.28	.47	1.18	1.50	.43	.75	.87	33.3	6.72			
	12	400	M 16 x 1,5	9	12	31,5	39,5	12,5	22	22	55	3,94	FI-GE-12LM-WD-B-W3		
	.47	5800		.35	.47	1.24	1.56	.49	.87	.87	40.7	8.66			
	12	400	M 18 x 1,5	10	12	31,5	39,5	12,5	24	22	90	4,90	FI-GE-12LM18x1.5-WD-B-W3		
	.47	5800		.39	.47	1.24	1.56	.49	.94	.87	66.6	10.78			
	12	400	M 22 x 1,5	10	14	35	42	14	27	22	125	6,96	FI-GE-12LM22x1.5-WD-B-W3		
	.47	5800		.39	.55	1.38	1.65	.55	1.06	.87	92.5	15.31			
	15	400	M 16 x 1,5	9	12	32,5	40,5	13,5	24	27	55	5,15	FI-GE-15LM16x1.5-WD-B-W3		
	.59	5800		.35	.47	1.28	1.59	.53	.94	1.06	40.7	11.33			
	15	400	M 18 x 1,5	11	12	32,5	40,5	13,5	24	27	90	5,05	FI-GE-15LM-WD-B-W3		
	.59	5800		.43	.47	1.28	1.59	.53	.94	1.06	66.6	11.11			
	15	400	M 22 x 1,5	12	14	35	43	14	27	27	125	7,15	FI-GE-15LM22x1.5-WD-B-W3		
	.59	5800		.47	.55	1.38	1.69	.55	1.06	1.06	92.5	15.73			
	15	250	M 26 x 1,5	18	16	38	46	15	32	27	180	9,56	FI-GE-15LM26x1.5-WD-B-W3		
	.59	3625		.71	.63	1.50	1.81	.59	1.26	1.06	133.2	21.08			

<sup>1</sup> Approximate dimension in assembled condition.

<sup>2</sup> Weight excluding cutting ring and union nut.

<sup>3</sup> Standard scope of delivery: Fitting body only.

Standard seal material is NBR (Buna-N®).

Male stud acc. to ISO 9974-2 (Type E)  
Port acc. to ISO 9974-1

Torque recommendations for Steel mating material.

Male threaded studs were designed for female threaded ports in components made of steel. For applications with components made of softer mating materials (e.g. Aluminium), the use of connectors with additionally rolled male threads is recommended.

Please contact STAUFF prior to the assembly for further information.



Straight Male Stud Fitting  
Type FI-GE-...-M-WD ▪ Series L

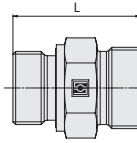
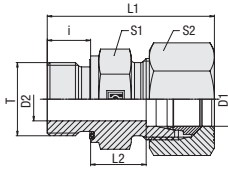

C

Metric Parallel Thread

Profile Sealing Ring

Series	Tube OD		PN	Dimensions								Torque (N·m/ft·lb)	Weight (kg/lbs) Ca. per 100	Ordering Codes <sup>3</sup>
	(mm/in)	(mm/in)		(mm/in)	Thread	T	D2	i	L	L <sup>1</sup>	L2			
L	18	400	5800	M 18 x 1,5	11	12	33,5	42,5	14	27	32	90	6,26	FI-GE-18LM18x1.5-WD-B-W3
	.71	.71			.43	.47	1.32	1.67	.55	1.06	1.26	66.6	13.77	
	18	400	5800	M 22 x 1,5	14	14	36	45	14,5	27	32	125	7,43	FI-GE-18LM-WD-B-W3
	.71	.71			.55	.55	1.42	1.77	.57	1.06	1.26	92.5	16.35	
	18	250	3625	M 26 x 1,5	15	16	38	47	16	32	32	180	10,88	FI-GE-18LM26x1.5-WD-B-W3
	.71	.71			.59	.63	1.50	1.85	.63	1.26	1.26	133.2	23.99	
	18	250	3625	M 27 x 2	15	16	38	47	14,5	32	32	180	11,17	FI-GE-18LM27x2-WD-B-W3
	.71	.71			.59	.63	1.50	1.85	.57	1.26	1.26	133.2	24.63	
	18	250	3625	M 33 x 2	15	18	41	49	15,5	41	32	310	13,17	FI-GE-18LM33x2-WD-B-W3
	.71	.71			.59	.71	1.61	1.93	.61	1.61	1.26	229.4	29.03	
	18	250	3625	M 18 x 1,5	15	12	35,5	44	16	32	36	90	8,00	FI-GE-22LM18x1.5-WD-B-W3
	.71	.71			.59	.47	1.40	1.73	.63	1.26	1.42	66.6	17.64	
	22	250	3625	M 22 x 1,5	14	14	38	47	16,5	32	36	125	9,10	FI-GE-22LM22x1.5-WD-B-W3
	.87	.87			.55	.55	1.50	1.85	.65	1.26	1.42	92.5	20.02	
	22	250	3625	M 26 x 1,5	18	16	40	49	16,5	32	36	180	10,23	FI-GE-22LM-WD-B-W3
	.87	.87			.71	.63	1.57	1.93	.65	1.26	1.42	133.2	22.51	
	22	250	3625	M 27 x 2	18	16	40	50	16,5	32	36	180	10,45	FI-GE-22LM27x2-WD-B-W3
	.87	.87			.71	.63	1.57	1.97	.65	1.26	1.42	133.2	23.04	
	22	250	3625	M 33 x 2	23	18	43	52	17,5	41	36	310	16,15	FI-GE-22LM33x2-WD-B-W3
	.87	.87			.91	.71	1.69	2.05	.69	1.61	1.42	229.4	35.60	
	28	250	3625	M 26 x 1,5	18	16	41	50	17,5	41	41	180	14,39	FI-GE-28LM26x1.5-WD-B-W3
	1.10	1.10			.71	.63	1.61	1.97	.69	1.61	1.61	133.2	31.72	
	28	250	3625	M 33 x 2	23	18	43	52	17,5	41	41	310	16,76	FI-GE-28LM-WD-B-W3
	1.10	1.10			.91	.71	1.69	2.05	.69	1.61	1.61	229.4	36.87	
	28	250	3625	M 42 x 2	30	20	46	55	18,5	50	41	450	26,5	FI-GE-28LM42x2-WD-B-W3
	1.10	1.10			1.18	.79	1.81	2.17	.73	1.97	1.61	333.0	58.42	
	35	250	3625	M 33 x 2	23	18	46	57	17,5	46	50	310	21,56	FI-GE-35LM33x2-WD-B-W3
	1.38	1.38			.91	.71	1.81	2.24	.69	1.81	1.97	229.4	47.53	
	35	250	3625	M 42 x 2	30	20	48	59	17,5	50	50	450	27,63	FI-GE-35LM-WD-B-W3
	1.38	1.38			1.18	.79	1.89	2.32	.69	1.97	1.97	333.0	60.79	
	42	250	3625	M 42 x 2	30	20	50	61	19	55	60	450	21,09	FI-GE-42LM42x2-WD-B-W3
	1.65	1.65			1.18	.79	1.97	2.40	.75	2.17	2.36	333.0	46.50	
	42	250	3625	M 48 x 2	36	22	52	64	19	55	60	540	34,63	FI-GE-42LM-WD-B-W3
	1.65	1.65			1.42	.87	2.05	2.52	.75	2.17	2.36	399.6	76.19	

<sup>1</sup> Approximate dimension in assembled condition.

<sup>2</sup> Weight excluding cutting ring and union nut.

<sup>3</sup> Standard scope of delivery: Fitting body only.

Standard seal material is NBR (Buna-N®).

Male stud acc. to ISO 9974-2 (Type E)

Port acc. to ISO 9974-1

Torque recommendations for Steel mating material.

Male threaded studs were designed for female threaded ports in components made of steel. For applications with components made of softer mating materials (e.g. Aluminium), the use of connectors with additionally rolled male threads is recommended.

Please contact STAUFF prior to the assembly for further information.

Ordering Codes

\*FI-GE\*-10\*L\*M\*-WD\*-B\*-W3\*-MS

- \* Straight Male Stud Fitting FI-GE
  - \* Outside Tube Diameter D1 (in mm) -10
  - \* Series Light Series (pages 52/53) L  
Heavy Series (page 54) S
  - \* Thread Type Metric Parallel Thread M
- If required, please indicate special sizes, e.g. M12x1.5!
- \* Seal Type Profile Sealing Ring -WD
  - \* Seal Material NBR (Buna-N®) -B  
FKM (Viton®) -V  
EPDM -E
  - \* Material Code Steel, zinc/nickel-plated -W3

- Please contact STAUFF for alternative materials and surface finishings.
- \* Assembling / Kitting Fitting body only —  
Fitting body supplied with cutting ring and union nut -MS  
Fitting body supplied with soft-sealing cutting ring and union nut -MSV

Connecting Parts

-  Cutting Ring Type FI-DS Page 28
-  Soft-Sealing Cutting Ring Type FI-WDDS Page 29
-  Support Sleeve Type FI-VH Page 31
-  STAUFF Form EVO Sealing Ring Type FI-FD Page 32
-  Union Nut Type FI-M Page 33
-  37° Flared Tube Fitting Set Type FI-AB Page 37

Spare Parts / Accessories

-  Profile Sealing Ring Type WDG Page 238



**Straight Male Stud Fitting**  
Type FI-GE-...-M-WD ▪ Series S

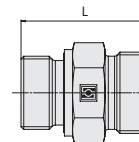
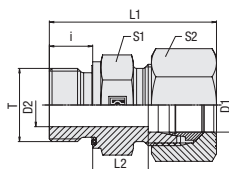

C

**Ordering Codes**

**\*FI-GE\*-10\*S\*M\*-WD\*-B\*-W3\*-MS**

- \* Straight Male Stud Fitting FI-GE
- \* Outside Tube Diameter D1 (in mm) -10
- \* Series L  
Light Series (pages 52/53)  
S  
Heavy Series (page 54)
- \* Thread Type M  
Metric Parallel Thread
- If required, please indicate special sizes, e.g. M12x1.5!
- \* Seal Type -WD  
Profile Sealing Ring
- \* Seal Material -B  
NBR (Buna-N®)  
-V  
FKM (Viton®)  
-E  
EPDM
- \* Material Code -W3  
Steel, zinc/nickel-plated
- Please contact STAUFF for alternative materials and surface finishings.
- \* Assembling / Kitting —  
Fitting body only
- Fitting body supplied with cutting ring and union nut -MS
- Fitting body supplied with soft-sealing cutting ring and union nut -MSV

**Connecting Parts**

- Cutting Ring  
Type FI-DS Page 28
- Soft-Sealing Cutting Ring  
Type FI-WDDS Page 29
- Support Sleeve  
Type FI-VH Page 31
- STAUFF Form EVO Sealing Ring  
Type FI-FD Page 32
- Union Nut  
Type FI-M Page 33
- 37° Flared Tube Fitting Set  
Type FI-AB Page 37

**Spare Parts / Accessories**

- Profile Sealing Ring  
Type WDG Page 238

**Profile Sealing Ring**

**Metric Parallel Thread**

Series	Tube OD (mm/in)	PN (bar/psi)	Dimensions (mm/in)										Torque (N·m/lbf·ft)	Weight (kg/lbs) ca. per 100	Ordering Codes <sup>3</sup>
			Thread	T	D2	i	L	L1 <sup>1</sup>	L2	S1	S2	Thread T			
S	6	800	M 12 x 1,5	4	12	32	40	13	17	17	35	2,93	FI-GE-06SM-WD-B-W3		
	.24	11600		.16	.47	1.26	1.57	.51	.67	.67	25.9	6.44			
	8	800	M 12 x 1,5	4	12	34	41	14,5	19	19	35	3,18	FI-GE-08SM12x1.5-WD-B-W3		
	.31	11600		.16	.47	1.34	1.61	.57	.75	.75	25.9	7.01			
	8	800	M 14 x 1,5	5	12	34	42	15	19	19	55	4,16	FI-GE-08SM-WD-B-W3		
	.31	11600		.20	.47	1.34	1.65	.59	.75	.75	40.7	9.16			
	10	800	M 14 x 1,5	5	12	34,5	43,5	15	19	22	55	4,97	FI-GE-10SM14x1.5-WD-B-W3		
	.39	11600		.20	.47	1.36	1.71	.59	.75	.87	40.7	10.93			
	10	800	M 16 x 1,5	7	12	34,5	43,5	15	22	22	70	5,36	FI-GE-10SM-WD-B-W3		
	.39	11600		.28	.47	1.36	1.71	.59	.87	.87	51.8	11.79			
	12	800	M 14 x 1,5	5	12	36	45	16,5	22	24	55	6,00	FI-GE-12SM14x1.5-WD-B-W3		
	.47	11600		.20	.47	1.42	1.77	.65	.87	.94	40.7	13.20			
	12	800	M 16 x 1,5	8	12	36	45	16,5	22	24	70	6,12	FI-GE-12SM16x1.5-WD-B-W3		
	0,47	11600		.31	.47	1.42	1.77	.65	.87	.94	51.8	13.47			
	12	630	M 18 x 1,5	8	12	36,5	45,5	17	24	24	90	7,12	FI-GE-12SM-WD-B-W3		
	.47	9135		.31	.47	1.44	1.79	.67	.94	.94	66.6	15.67			
	12	630	M 22 x 1,5	8	14	39	48	17,5	27	24	135	9,28	FI-GE-12SM22x1.5-WD-B-W3		
	.47	9135		.31	.55	1.54	1.89	.69	1.06	.94	99.9	20.42			
	14	630	M 20 x 1,5	10	14	41	51	19	27	27	125	9,46	FI-GE-14SM-WD-B-W3		
	.55	9135		.39	.55	1.61	2.01	.75	1.06	1.06	92.5	20.82			
	16	630	M 18 x 1,5	8	12	38,5	48,5	18	24	30	90	7,82	FI-GE-16SM18x1.5-WD-B-W3		
	.63	9135		.31	.47	1.52	1.91	.71	.94	1.18	66.6	17.20			
	16	630	M 22 x 1,5	12	14	41	51	18,5	27	30	135	9,52	FI-GE-16SM-WD-B-W3		
	.63	9135		.47	.55	1.61	2.01	.73	1.06	1.18	99.9	20.95			
	16	420	M 27 x 2	12	16	43	53	18,5	32	30	180	14,46	FI-GE-16SM27x2-WD-B-W3		
	.63	6091		.47	.63	1.69	2.09	.73	1.26	1.18	133.2	31.88			
	20	420	M 22 x 1,5	12	14	45	56	20,5	32	36	135	14,03	FI-GE-20SM22x1.5-WD-B-W3		
	.79	6091		.47	.55	1.77	2.20	.81	1.26	1.42	99.9	30.93			
20	420	M 27 x 2	16	16	47	58	20,5	32	36	180	15,10	FI-GE-20SM-WD-B-W3			
.79	6091		.63	.63	1.85	2.28	.81	1.26	1.42	133.2	33.22				
25	420	M 26 x 1,5	15	16	51	62	23	41	46	180	24,27	FI-GE-25SM26x1.5-WD-B-W3			
.98	6091		.59	.63	2.01	2.44	.91	1.61	1.81	133.2	53.51				
25	420	M 27 x 2	16	16	51	62	23	41	46	180	24,42	FI-GE-25SM27x2-WD-B-W3			
.98	6091		.63	.63	2.01	2.44	.91	1.61	1.81	133.2	53.84				
25	420	M 33 x 2	20	18	53	65	23	41	46	310	26,43	FI-GE-25SM-WD-B-W3			
.98	6091		.79	.71	2.09	2.56	.91	1.61	1.81	229.4	58.15				
30	420	M 33 x 2	20	18	55	68	23,5	50	50	310	37,1	FI-GE-30SM33x2-WD-B-W3			
1.18	6091		.79	.71	2.17	2.68	.93	1.97	1.97	229.4	81.79				
30	420	M 42 x 2	25	20	57	70	23,5	50	50	450	41,84	FI-GE-30SM-WD-B-W3			
1.18	6091		.98	.79	2.24	2.76	.93	1.97	1.97	333.0	92.06				
38	420	M 48 x 2	32	22	64	79	26	55	60	540	57,00	FI-GE-38SM-WD-B-W3			
1.50	6091		1.26	.87	2.52	3.11	1.02	2.17	2.36	399.6	125.40				

<sup>1</sup> Approximate dimension in assembled condition.

<sup>2</sup> Weight excluding cutting ring and union nut.

<sup>3</sup> Standard scope of delivery: Fitting body only.

Male stud acc. to ISO 9974-2 (Type E)

Port acc. to ISO 9974-1

Torque recommendations for Steel mating material.

Standard seal material is NBR (Buna-N®).

Male threaded studs were designed for female threaded ports in components made of steel. For applications with components made of softer mating materials (e.g. Aluminium), the use of connectors with additionally rolled male threads is recommended.

Please contact STAUFF prior to the assembly for further information.



Straight Male Stud Fitting  
Type FI-GE-...-R-DF • Series L

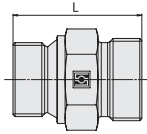
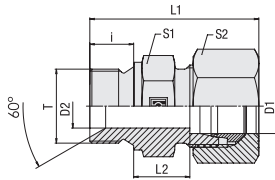

C

Whitworth Parallel Pipe Thread (BSPP) 60° Conical Bore / Sealing Surface for Gaskets

Series	Tube OD (mm/in)	PN (bar/psi)	Dimensions (mm/in)										Torque (N-m/lb-ft)	Weight (kg/lbs) ca. per 100	Ordering Codes <sup>3</sup>
			D1	Thread	T	D2	i	L	L1 <sup>1</sup>	L2	S1	S2			
L	6	250	G 1/8	3,5	8	23,5	31,5	8,5	14	14	20	1,38	FI-GE-06LR-DF-W3		
	.24	3625		.14	.31	.93	1.24	.33	.55	.55	14.8	3.04			
6	250		G 1/4	4	12	29	36	10	19	14	50	2,75	FI-GE-06LR1/4-DF-W3		
	.24	3625		.16	.47	1.14	1.42	.39	.75	.55	37.0	6.05			
6	250		G 3/8	7,9	12	30,5	38	11	22	14	80	3,94	FI-GE-06LR3/8-DF-W3		
	.24	3625		.31	.47	1.20	1.50	.43	.87	.55	59.2	8.68			
8	250		G 1/8	3,5	8	24,5	32	10	14	17	20	1,71	FI-GE-08LR1/8-DF-W3		
	.31	3625		.14	.31	.96	1.26	.39	.55	.67	14.8	3.76			
8	250		G 1/4	4,7	12	29	37	10	19	17	50	2,87	FI-GE-08LR-DF-W3		
	.31	3625		.19	.47	1.14	1.46	.39	.75	.67	37.0	6.31			
8	250		G 3/8	6	12	30,5	38	11	22	17	80	4,28	FI-GE-08LR3/8-DF-W3		
	.31	3625		.24	.47	1.20	1.50	.43	.87	.67	59.2	9.41			
10	250		G 1/4	4,7	12	30	38	11	19	19	50	2,82	FI-GE-10LR-DF-W3		
	.39	3625		.19	.47	1.18	1.50	.43	.75	.75	37.0	6.21			
10	250		G 3/8	7,9	12	31,5	39	12,5	22	19	80	4,18	FI-GE-10LR3/8-DF-W3		
	.39	3625		.31	.47	1.24	1.54	.49	.87	.75	59.2	9.19			
10	160		G 1/2	11,1	14	34	41	13	27	19	140	6,28	FI-GE-10LR1/2-DF-W3		
	.39	2320		.44	.55	1.34	1.61	.51	1.06	.75	103.6	13.81			
12	250		G 1/4	4,7	12	31	39	12	19	22	50	3,30	FI-GE-12LR1/4-DF-W3		
	.47	3625		.19	.47	1.22	1.54	.47	.75	.87	37.0	7.26			
12	250		G 3/8	7,9	12	31,5	39,5	12,5	22	22	80	4,39	FI-GE-12LR-DF-W3		
	.47	3625		.31	.47	1.24	1.56	.49	.87	.87	59.2	9.66			
12	160		G 1/2	10	14	34	42	13	27	22	140	6,47	FI-GE-12LR1/2-DF-W3		
	.47	2320		.39	.55	1.34	1.65	.51	1.06	.87	103.6	14.23			
15	250		G 3/8	7,9	12	32,5	40	13,5	24	27	80	5,18	FI-GE-15LR3/8-DF-W3		
	.59	3625		.31	.47	1.28	1.57	.53	.94	1.06	59.2	11.39			
15	160		G 1/2	11,1	14	35	40,5	14	27	27	140	6,98	FI-GE-15LR-DF-W3		
	.59	2320		.44	.55	1.38	1.59	.55	1.06	1.06	103.6	15.35			
18	250		G 3/8	7,9	12	33,5	41	14	27	32	80	4,90	FI-GE-18LR3/8-DF-W3		
	.71	3625		.31	.47	1.32	1.61	.55	1.06	1.26	59.2	10.78			
18	160		G 1/2	11,1	14	35	45	13,5	27	32	140	5,35	FI-GE-18LR-DF-W3		
	.71	2320		.44	.55	1.38	1.77	.53	1.06	1.26	103.6	11.77			
18	160		G 3/4	15	16	38	47	14,5	32	32	190	10,79	FI-GE-18LR3/4-DF-W3		
	.71	2320		.59	.63	1.50	1.85	.57	1.26	1.26	140.6	23.74			
22	160		G 1/2	11,1	14	38	47	16,5	32	36	140	9,53	FI-GE-22LR1/2-DF-W3		
	.87	2320		.44	.55	1.50	1.85	.65	1.26	1.42	103.6	20.96			
22	160		G 3/4	16,7	16	40	49	16,5	32	36	190	9,94	FI-GE-22LR-DF-W3		
	.87	2320		.66	.63	1.57	1.93	.65	1.26	1.42	140.6	21.88			
22	160		G 1	22,2	18	43	51	17,5	41	36	330	16,58	FI-GE-22LR1-DF-W3		
	.87	2320		.87	.71	1.69	2.01	.69	1.61	1.42	244.2	36.48			
28	160		G 1/2	11,1	14	39	48	17,5	41	41	140	13,58	FI-GE-28LR1/2-DF-W3		
	1.10	2320		.44	.55	1.54	1.89	.69	1.61	1.61	103.6	29.88			
28	160		G 3/4	16,7	16	41	50	17,5	41	41	190	15,87	FI-GE-28LR3/4-DF-W3		
	1.10	2320		.66	.63	1.61	1.97	.69	1.61	1.61	140.6	34.91			
28	160		G 1	22,2	18	43	52	17,5	41	41	330	17,46	FI-GE-28LR-DF-W3		
	1.10	2320		.87	.71	1.69	2.05	.69	1.61	1.61	244.2	38.41			
28	160		G 1 1/4	28,6	20	48	57	20,5	50	41	540	20,04	FI-GE-28LR1-1/4-DF-W3		
	1.10	2320		1.13	.79	1.89	2.24	.81	1.97	1.61	399.6	44.09			
35	160		G 1	22,2	18	46	57	17,5	50	50	330	24,26	FI-GE-35LR1-DF-W3		
	1.38	2320		.87	.71	1.81	2.24	.69	1.97	1.97	244.2	53.37			
35	125		G 1 1/4	28,6	20	48	59	17,5	50	50	540	28,81	FI-GE-35LR-DF-W3		
	1.38	1813		1.13	.79	1.89	2.32	.69	1.97	1.97	399.6	63.37			
42	125		G 1 1/4	28,6	20	50	62	19	55	60	540	33,91	FI-GE-42LR1-1/4-DF-W3		
	1.65	1813		1.13	.79	1.97	2.44	.75	2.17	2.36	399.6	74.59			
42	125		G 1 1/2	33,3	22	52	64	19	55	60	630	36,75	FI-GE-42LR-DF-W3		
	1.65	1813		1.31	.87	2.05	2.52	.75	2.17	2.36	466.2	80.85			

<sup>1</sup> Approximate dimension in assembled condition.  
<sup>2</sup> Weight excluding cutting ring and union nut.  
<sup>3</sup> Standard scope of delivery: Fitting body only.

Male stud acc. to DIN 3852-2 (Form A)  
 Port acc. to DIN 3852-2 (Form X) / ISO 1179-1

Torque recommendations for Steel mating material.

Ordering Codes

\*FI-GE\*-10\*L\*R\*-DF\*-W3\*-MS

* Straight Male Stud Fitting	FI-GE
* Outside Tube Diameter D1 (in mm)	-10
* Series	Light Series (page 55) <b>L</b> Heavy Series (page 56) <b>S</b>
* Thread Type	Whitworth Parallel Pipe Thread (BSPP) <b>R</b>
If required, please indicate special sizes, e.g. R1/8!	
* Seal Type	60° Conical Bore (BS 5200) / Sealing Surface for Gasket (DIN 7603) <b>-DF</b>
* Material Code	Steel, zinc/nickel-plated <b>-W3</b>
Please contact STAUFF for alternative materials and surface finishings.	
* Assembling / Kitting	Fitting body only <b>—</b>
	Fitting body supplied with cutting ring and union nut <b>-MS</b>
	Fitting body supplied with soft-sealing cutting ring and union nut <b>-MSV</b>

Connecting Parts

	Cutting Ring Type <b>FI-DS</b>	Page 28
	Soft-Sealing Cutting Ring Type <b>FI-WDDS</b>	Page 29
	Support Sleeve Type <b>FI-VH</b>	Page 31
	STAUFF Form EVO Sealing Ring Type <b>FI-FD</b>	Page 32
	Union Nut Type <b>FI-M</b>	Page 33
	37° Flared Tube Fitting Set Type <b>FI-AB</b>	Page 37

Male threaded studs were designed for female threaded ports in components made of steel. For applications with components made of softer mating materials (e.g. Aluminium), the use of connectors with additionally rolled male threads is recommended. Please contact STAUFF prior to the assembly for further information.



**Straight Male Stud Fitting**  
Type FI-GE-...-R-DF • Series S

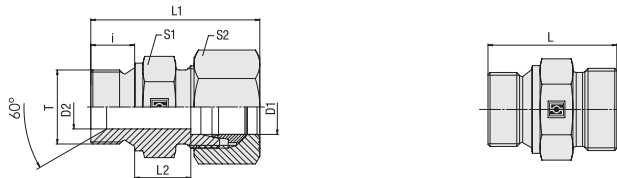

C

60° Conical Bore / Sealing Surface for Gaskets

Whitworth Parallel Pipe Thread (BSPP)

**Ordering Codes**

**\*FI-GE\*-10\*S\*R\*-DF\*-W3\*-MS**

- \* Straight Male Stud Fitting **FI-GE**
- \* Outside Tube Diameter D1 (in mm) **-10**
- \* Series **L**  
Light Series (page 55)  
Heavy Series (page 56)
- \* Thread Type **R**  
Whitworth Parallel  
Pipe Thread (BSPP)
- If required, please indicate special sizes, e.g. R1/8!
- \* Seal Type **DF**  
60° Conical Bore (BS 5200) /  
Sealing Surface for Gasket  
(DIN 7603)
- \* Material Code **-W3**  
Steel, zinc/nickel-plated
- Please contact STAUFF for alternative  
materials and surface finishings.
- \* Assembling / Kitting **—**  
Fitting body only
- Fitting body supplied with  
cutting ring and union nut **-MS**
- Fitting body supplied with  
soft-sealing cutting ring  
and union nut **-MSV**

**Connecting Parts**

- Cutting Ring  
Type **FI-DS** Page 28
- Soft-Sealing Cutting Ring  
Type **FI-WDDS** Page 29
- Support Sleeve  
Type **FI-VH** Page 31
- STAUFF Form EVO Sealing Ring  
Type **FI-FD** Page 32
- Union Nut  
Type **FI-M** Page 33
- 37° Flared Tube Fitting Set  
Type **FI-AB** Page 37

<sup>1</sup> Approximate dimension in assembled condition.

<sup>2</sup> Weight excluding cutting ring and union nut.

<sup>3</sup> Standard scope of delivery: Fitting body only.

Male stud acc. to DIN 3852-2 (Form A)

Port acc. to DIN 3852-2 (Form X) / ISO 1179-1

Torque recommendations for Steel mating material.

Male threaded studs were designed for female threaded ports in components made of steel. For applications with components made of softer mating materials (e.g. Aluminium), the use of connectors with additionally rolled male threads is recommended.

Please contact STAUFF prior to the assembly for further information.

Series	Tube OD (mm/in)	PN (bar/psi)	Dimensions (mm/in)										Torque (Nm/ft-lb)	Weight (kg/lbs) ca.	Ordering Codes <sup>3</sup>
			D1	Thread	T	D2	i	L	L <sup>1</sup>	L2	S1	S2			
S	6	250	G 1/8	3,5	8	27,5	35	12,5	14	17	20	2,09	FI-GE-06SR1/8-DF-W3		
	.24	3625		.14	.31	1.08	1.38	.49	.55	.67	14.7	4.59			
	6	250	G 1/4	4	12	32	40	13	19	17	60	3,48	FI-GE-06SR-DF-W3		
	.24	3625		.16	.47	1.26	1.57	.51	.75	.67	44.4	7.66			
	6	250	G 3/8	7,9	12	34,5	42	15,5	22	17	100	4,63	FI-GE-06SR3/8-DF-W3		
	.24	3625		.31	.47	1.36	1.65	.61	.87	.67	74.0	10.18			
	6	250	G 1/2	11,1	14	35	43	14	27	17	160	6,22	FI-GE-06SR1/2-DF-W3		
	.24	3625		.44	.55	1.38	1.69	.55	1.06	.67	118.4	13.68			
	8	250	G 1/8	3,5	8	27,5	35	12,5	14	17	20	2,71	FI-GE-08SR1/8-DF-W3		
	.31	3625		.14	.31	1.08	1.38	.49	.55	.67	14.7	5.97			
	8	250	G 1/4	4,7	12	34	42	15	19	19	60	4,10	FI-GE-08SR-DF-W3		
	.31	3625		.19	.47	1.34	1.65	.59	.75	.75	44.4	9.01			
	8	250	G 3/8	7,9	12	34,5	42	15,5	22	19	100	5,25	FI-GE-08SR3/8-DF-W3		
	.31	3625		.31	.47	1.36	1.65	.61	.87	.75	74.0	11.56			
	8	250	G 1/2	11,1	14	39	47	18	27	19	160	8,47	FI-GE-08SR1/2-DF-W3		
	.31	3625		.44	.55	1.54	1.85	.71	1.06	.75	118.4	18.63			
	10	250	G 1/4	4,7	12	34	42	14,5	19	22	60	4,33	FI-GE-10SR1/4-DF-W3		
	.39	3625		.19	.47	1.34	1.65	.57	.75	.87	44.4	9.52			
	10	250	G 3/8	7	12	34,5	43,5	15	22	22	100	5,46	FI-GE-10SR-DF-W3		
	.39	3625		.28	.47	1.36	1.71	.59	.87	.87	74.0	12.01			
	10	160	G 1/2	11,1	14	35	43	13,5	27	22	160	6,76	FI-GE-10SR1/2-DF-W3		
	.39	2320		.44	.55	1.38	1.69	.53	1.06	.87	118.4	14.87			
	12	250	G 1/4	4,7	12	36	44	16,5	22	24	60	5,70	FI-GE-12SR1/4-DF-W3		
	.47	3625		.19	.47	1.42	1.73	.65	.87	.94	44.4	12.53			
	12	250	G 3/8	7,9	12	36,5	45,5	17	22	24	100	6,17	FI-GE-12SR-DF-W3		
	.47	3625		.31	.47	1.44	1.79	.67	.87	.94	74.0	13.57			
	12	160	G 1/2	11,1	14	39	48	17,5	27	24	160	8,75	FI-GE-12SR1/2-DF-W3		
	.47	2320		.44	.55	1.54	1.89	.69	1.06	.94	118.4	19.25			
	12	160	G 3/4	16,7	16	43	51	19,5	32	24	280	12,90	FI-GE-12SR3/4-DF-W3		
	.47	2320		.66	.63	1.69	2.01	.77	1.26	.94	207.2	28.37			
	14	160	G 1/2	10	14	41	51	19	27	27	160	9,56	FI-GE-14SR-DF-W3		
	.55	2320		.39	.55	1.61	2.01	.75	1.06	1.06	118.4	21.03			
	16	250	G 3/8	7,9	12	38,5	48	18	27	30	100	6,82	FI-GE-16SR3/8-DF-W3		
	.63	3625		.31	.47	1.52	1.89	.71	1.06	1.18	74.0	15.01			
	16	160	G 1/2	11,1	14	41	51	18,5	27	30	160	9,05	FI-GE-16SR-DF-W3		
	.63	2320		.44	.55	1.61	2.01	.73	1.06	1.18	118.4	19.92			
	16	160	G 3/4	16,7	16	45	55	20,5	32	30	280	13,31	FI-GE-16SR3/4-DF-W3		
	.63	2320		.66	.63	1.77	2.17	.81	1.26	1.18	207.2	29.27			
	20	160	G 1/2	11,1	14	45	54	20,5	32	36	160	13,74	FI-GE-20SR1/2-DF-W3		
	.79	2320		.44	.55	1.77	2.13	.81	1.26	1.42	118.4	30.22			
	20	160	G 3/4	16	16	47	58	20,5	32	36	280	14,90	FI-GE-20SR-DF-W3		
	.79	2320		.63	.63	1.85	2.28	.81	1.26	1.42	207.2	32.77			
	20	160	G 1	22,2	18	51	62	22,5	41	36	440	23,12	FI-GE-20SR1-DF-W3		
	.79	2320		.87	.71	2.01	2.44	.89	1.61	1.42	325.6	50.86			
	25	160	G 1/2	11,1	14	49	56	23	41	46	160	23,68	FI-GE-25SR1/2-DF-W3		
	.98	2320		.44	.55	1.93	2.20	.91	1.61	1.81	118.4	52.10			
	25	160	G 3/4	16,7	16	51	63	23	41	46	280	23,73	FI-GE-25SR3/4-DF-W3		
	.98	2320		.66	.63	2.01	2.48	.91	1.61	1.81	207.2	52.21			
25	160	G 1	20	18	53	65	23	41	46	440	20,71	FI-GE-25SR-DF-W3			
.98	2320		.79	.71	2.09	2.56	.91	1.61	1.81	325.6	45.55				
30	160	G 3/4	16,7	16	53	66	23,5	50	50	280	33,85	FI-GE-30SR3/4-DF-W3			
1.18	2320		.66	.63	2.09	2.60	.93	1.97	1.97	207.2	74.47				
30	160	G 1	22,2	18	55	68	23,5	46	50	440	32,20	FI-GE-30SR1-DF-W3			
1.18	2320		.87	.71	2.17	2.68	.93	1.81	1.97	325.6	70.84				
30	125	G 1 1/4	25	20	57	70	23,5	50	50	580	40,27	FI-GE-30SR-DF-W3			
1.18	1813		.98	.79	2.24	2.76	.93	1.97	1.97	429.2	88.59				
38	160	G 1	22,2	18	60	73	26	55	60	440	47,79	FI-GE-38SR1-DF-W3			
1.50	2320		.87	.71	2.36	2.87	1.02	2.17	2.36	325.6	105.13				
38	125	G 1 1/4	38,6	20	62	77	26	55	60	580	51,40	FI-GE-38SR1-1/4-DF-W3			
1.50	1813		1.52	.79	2.44	3.03	1.02	2.17	2.36	429.2	113.08				
38	125	G 1 1/2	32	22	64	79	26	55	60	700	54,70	FI-GE-38SR-DF-W3			
1.50	1813		1.26	.87	2.52	3.11	1.02	2.17	2.36	518.0	120.34				





Straight Male Stud Fitting  
Type FI-GE-...-M-OR • Series L

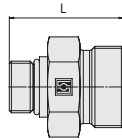
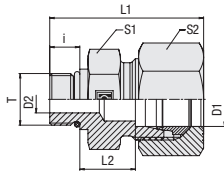

C

Metric Parallel Thread

O-Ring

Series	Tube OD (mm/in)	PN (bar/psi)	Dimensions (mm/in)										Torque (N•m/ft•lb)	Weight (kg/lbs) Ca. per 100	Ordering Codes <sup>3</sup>
			Thread	T	D2	i	L	L1 <sup>1</sup>	L2	S1	S2	Thread T			
L	6	500	M 10 x 1	4	8,5	25	33	9,5	14	14	15	1,53	FI-GE-06LM-OR-B-W3		
	.24	7250		.16	.33	.98	1.30	.37	.55	.55	11.1	3.36			
8	500	500	M 10 x 1	3	8,5	25	32	9,5	14	17	15	1,66	FI-GE-08LM10x1-OR-B-W3		
	.31	7250		.12	.33	.98	1.26	.37	.55	.67	11.1	3.66			
8	500	500	M 12 x 1,5	6	11	28	36	10	17	17	25	2,16	FI-GE-08LM-OR-B-W3		
	.31	7250		.24	.43	1.10	1.42	.39	.67	.67	18.5	4.75			
8	500	500	M 14 x 1,5	6	11	33	40	15	19	17	35	3,9	FI-GE-08LM14x1.5-OR-B-W3		
	.31	7250		.24	.43	1.30	1.57	.59	.75	.67	25.9	8.60			
8	400	5800	M 18 x 1,5	11	12,5	31	36	11,5	24	17	45	4,43	FI-GE-08LM18x1.5-OR-B-W3		
	.31	5800		.43	.49	1.22	1.42	.45	.94	.67	33.3	9.76			
10	500	500	M 12 x 1,5	6	11	29	36	11	19	19	25	2,66	FI-GE-10LM12x1.5-OR-B-W3		
	.39	7250		.24	.43	1.14	1.42	.43	.75	.75	18.5	5.86			
10	500	500	M 14 x 1,5	7,5	11	29	37	11	19	19	35	2,87	FI-GE-10LM-OR-B-W3		
	.39	7250		.30	.43	1.14	1.46	.43	.75	.75	25.9	6.31			
10	400	5800	M 18 x 1,5	8	12,5	32	39	12,5	24	19	45	5,23	FI-GE-10LM18x1.5-OR-B-W3		
	.39	5800		.31	.49	1.26	1.54	.49	.94	.75	33.3	11.53			
12	400	5800	M 12 x 1,5	6	11	30,5	38	12,5	19	22	25	2,89	FI-GE-12LM12x1.5-OR-B-W3		
	.47	5800		.24	.43	1.20	1.50	.49	.75	.87	18.5	6.37			
12	400	5800	M 14 x 1,5	7,5	11	31	39	13	19	22	35	3,45	FI-GE-12LM14x1.5-OR-B-W3		
	.47	5800		.30	.43	1.22	1.54	.51	.75	.87	25.9	7.61			
12	400	5800	M 16 x 1,5	9	11,5	31	39	12,5	22	22	40	4,10	FI-GE-12LM-OR-B-W3		
	.47	5800		.35	.45	1.22	1.54	.49	.87	.87	29.6	9.01			
12	400	5800	M 18 x 1,5	10	12,5	32	40	12,5	24	22	45	5,14	FI-GE-12LM18x1.5-OR-B-W3		
	.47	5800		.39	.49	1.26	1.57	.49	.94	.87	33.3	11.33			
15	400	5800	M 18 x 1,5	11	12,5	33	41	13,5	24	27	45	5,32	FI-GE-15LM-OR-B-W3		
	.59	5800		.43	.49	1.30	1.61	.53	.94	1.06	33.3	11.71			
18	400	5800	M 22 x 1,5	14	13	35	44	14,5	27	32	60	7,55	FI-GE-18LM-OR-B-W3		
	.71	5800		.55	.51	1.38	1.73	.57	1.06	1.26	44.4	16.60			
22	400	5800	M 22 x 1,5	14	13	37	46	16,5	32	36	60	9,22	FI-GE-22LM22x1.5-OR-B-W3		
	.87	5800		.55	.51	1.46	1.81	.65	1.26	1.42	44.4	20.33			
22	250	3625	M 27 x 2	18	16	40	49	16,5	32	36	100	10,79	FI-GE-22LM27x2-OR-B-W3		
	.87	3625		.71	.63	1.57	1.93	.65	1.26	1.42	74.0	23.73			
22	250	3625	M 33 x 2	14	16	41	46	16,5	41	36	160	16,14	FI-GE-22LM33x2-OR-B-W3		
	.87	3625		.55	.63	1.61	1.81	.65	1.61	1.42	118.4	35.58			
28	250	3625	M 27 x 2	18	16	40,5	52	17	41	41	100	14,47	FI-GE-28LM27x2-OR-B-W3		
	1.10	3625		.71	.63	1.59	2.05	.67	1.61	1.61	74.0	31.90			
28	250	3625	M 33 x 2	23	16	41	50	17,5	41	41	160	16,73	FI-GE-28LM-OR-B-W3		
	1.10	3625		.91	.63	1.61	1.97	.69	1.61	1.61	118.4	36.81			
35	250	3625	M 42 x 2	30	16	44	55	17,5	50	50	210	26,66	FI-GE-35LM-OR-B-W3		
	1.38	3625		1.18	.63	1.73	2.17	.69	1.97	1.97	155.4	58.66			
42	250	3625	M 48 x 2	36	17,5	47,5	59,5	19	55	60	260	33,79	FI-GE-42LM-OR-B-W3		
	1.65	3625		1.42	.69	1.87	2.34	.75	2.17	2.36	192.4	74.34			

<sup>1</sup> Approximate dimension in assembled condition.

<sup>2</sup> Weight excluding cutting ring and union nut.

<sup>3</sup> Standard scope of delivery: Fitting body only.

Male stud acc. to ISO 6149-2/-3

Port acc. to ISO 6149-1

Torque recommendations for Steel mating material.

Standard seal material is NBR (Buna-N®).

Male threaded studs were designed for female threaded ports in components made of steel. For applications with components made of softer mating materials (e.g. Aluminium), the use of connectors with additionally rolled male threads is recommended.

Please contact STAUFF prior to the assembly for further information.

Ordering Codes

\*FI-GE\*-10\*L\*LM\*-OR\*-B\*-W3\*-MS

* Straight Male Stud Fitting	FI-GE
* Outside Tube Diameter D1 (in mm)	-10
* Series	Light Series (page 57) <b>L</b> Heavy Series (page 58) <b>S</b>
* Thread Type	Metric Parallel Thread <b>M</b>
If required, please indicate special sizes, e.g. M12x1.5!	
* Seal Type	O-Ring <b>-OR</b>
* Seal Material	NBR (Buna-N®) <b>-B</b> FKM (Viton®) <b>-V</b> EPDM <b>-E</b>
* Material Code	Steel, zinc/nickel-plated <b>-W3</b>
Please contact STAUFF for alternative materials and surface finishings.	
* Assembling / Kitting	Fitting body only <b>—</b>
	Fitting body supplied with cutting ring and union nut <b>-MS</b>
	Fitting body supplied with soft-sealing cutting ring and union nut <b>-MSV</b>

Connecting Parts

	Cutting Ring Type <b>FI-DS</b>	Page 28
	Soft-Sealing Cutting Ring Type <b>FI-WDDS</b>	Page 29
	Support Sleeve Type <b>FI-VH</b>	Page 31
	STAUFF Form EVO Sealing Ring Type <b>FI-FD</b>	Page 32
	Union Nut Type <b>FI-M</b>	Page 33
	37° Flared Tube Fitting Set Type <b>FI-AB</b>	Page 37

Spare Parts / Accessories

	O-Ring Type <b>O-RING</b>	Page 239
--	------------------------------	----------



**Straight Male Stud Fitting**  
Type FI-GE-...-M-OR • Series S

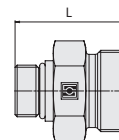
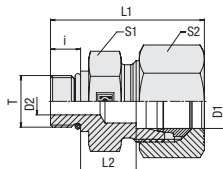

C

**Metric Parallel Thread**

**O-Ring**

**Ordering Codes**

**\*FI-GE\*-10\*S\*M\*-OR\*-B\*-W3\*-MS**

- \* Straight Male Stud Fitting **FI-GE**
- \* Outside Tube Diameter D1 (in mm) **-10**
- \* Series Light Series (page 57) **L**  
Heavy Series (page 58) **S**
- \* Thread Type Metric Parallel Thread **M**  
If required, please indicate special sizes, e.g. M12x1.5!
- \* Seal Type O-Ring **-OR**
- \* Seal Material NBR (Buna-N®) **-B**  
FKM (Viton®) **-V**  
EPDM **-E**
- \* Material Code Steel, zinc/nickel-plated **-W3**  
Please contact STAUFF for alternative materials and surface finishings.
- \* Assembling / Kitting Fitting body only **—**  
Fitting body supplied with cutting ring and union nut **-MS**  
Fitting body supplied with soft-sealing cutting ring and union nut **-MSV**

Series	Tube OD (mm/in)	PN (bar/psi)	Dimensions (mm/in)										Torque (N-m/ft-lb)	Weight (kg/lbs) ca. per 100	Ordering Codes <sup>3</sup>
			Thread T	D2	i	L	L1 <sup>1</sup>	L2	S1	S2	Thread T				
S	6	800	M 12 x 1,5	4	11	31	39	13	17	17	35	2,93	FI-GE-06SM-OR-B-W3		
	.24	11600		.16	.43	1.22	1.54	.51	.67	.67	25.9	6.44			
	8	800	M 14 x 1,5	5	11	33	41	15	19	19	40	4,22	FI-GE-08SM-OR-B-W3		
	.31	11600		.20	.43	1.30	1.61	.59	.75	.75	29.6	9.28			
	10	800	M 16 x 1,5	7	12,5	35	44	15	22	22	55	6,11	FI-GE-10SM-OR-B-W3		
	.39	11600		.28	.49	1.38	1.73	.59	.87	.87	40.7	13.43			
	12	630	M 14 x 1,5	6	11	35,5	44	17	24	19	40	6	FI-GE-12SM14x1.5-OR-B-W3		
	.47	9135		.24	.43	1.40	1.73	.67	.94	.75	29.6	13.23			
	12	630	M 18 x 1,5	8	14	38,5	47,5	17	24	24	70	3,41	FI-GE-12SM-OR-B-W3		
	.47	9135		.31	.55	1.52	1.87	.67	.94	.94	51.8	7.51			
	16	630	M 22 x 1,5	12	15	42	52	18,5	27	30	100	6,37	FI-GE-16SM-OR-B-W3		
	.63	9135		.47	.59	1.65	2.05	.73	1.06	1.18	74.0	14.01			
	20	420	M 27 x 2	15	18,5	49,5	60,5	20,5	32	36	170	16,88	FI-GE-20SM-OR-B-W3		
	.79	6091		.59	.73	1.95	2.38	.81	1.26	1.42	125.8	37.13			
	25	420	M 33 x 2	20	18,5	53,5	65,5	23	41	46	310	27,42	FI-GE-25SM-OR-B-W3		
	.98	6091		.79	.73	2.11	2.58	.91	1.61	1.81	229.4	60.33			
30	420	M 42 x 2	25	19	56	69	23,5	50	50	330	42,45	FI-GE-30SM-OR-B-W3			
1.18	6091		.98	.75	2.20	2.72	.93	1.97	1.97	244.2	93.39				
38	420	M 48 x 2	32	21,5	63,5	78,5	26	55	60	420	58,60	FI-GE-38SM-OR-B-W3			
1.50	6091		1.26	.85	2.50	3.09	1.02	2.17	2.36	310.8	128.92				

<sup>1</sup> Approximate dimension in assembled condition.

<sup>2</sup> Weight excluding cutting ring and union nut.

<sup>3</sup> Standard scope of delivery: Fitting body only.

Male stud acc. to ISO 6149-2/-3

Port acc. to ISO 6149-1

Torque recommendations for Steel mating material.

Standard seal material is NBR (Buna-N®).

Male threaded studs were designed for female threaded ports in components made of steel. For applications with components made of softer mating materials (e.g. Aluminium), the use of connectors with additionally rolled male threads is recommended.

Please contact STAUFF prior to the assembly for further information.

**Connecting Parts**

-  Cutting Ring  
Type **FI-DS** Page 28
-  Soft-Sealing Cutting Ring  
Type **FI-WDDS** Page 29
-  Support Sleeve  
Type **FI-VH** Page 31
-  STAUFF Form EVO Sealing Ring  
Type **FI-FD** Page 32
-  Union Nut  
Type **FI-M** Page 33
-  37° Flared Tube Fitting Set  
Type **FI-AB** Page 37

**Spare Parts / Accessories**

-  O-Ring  
Type **O-RING** Page 239



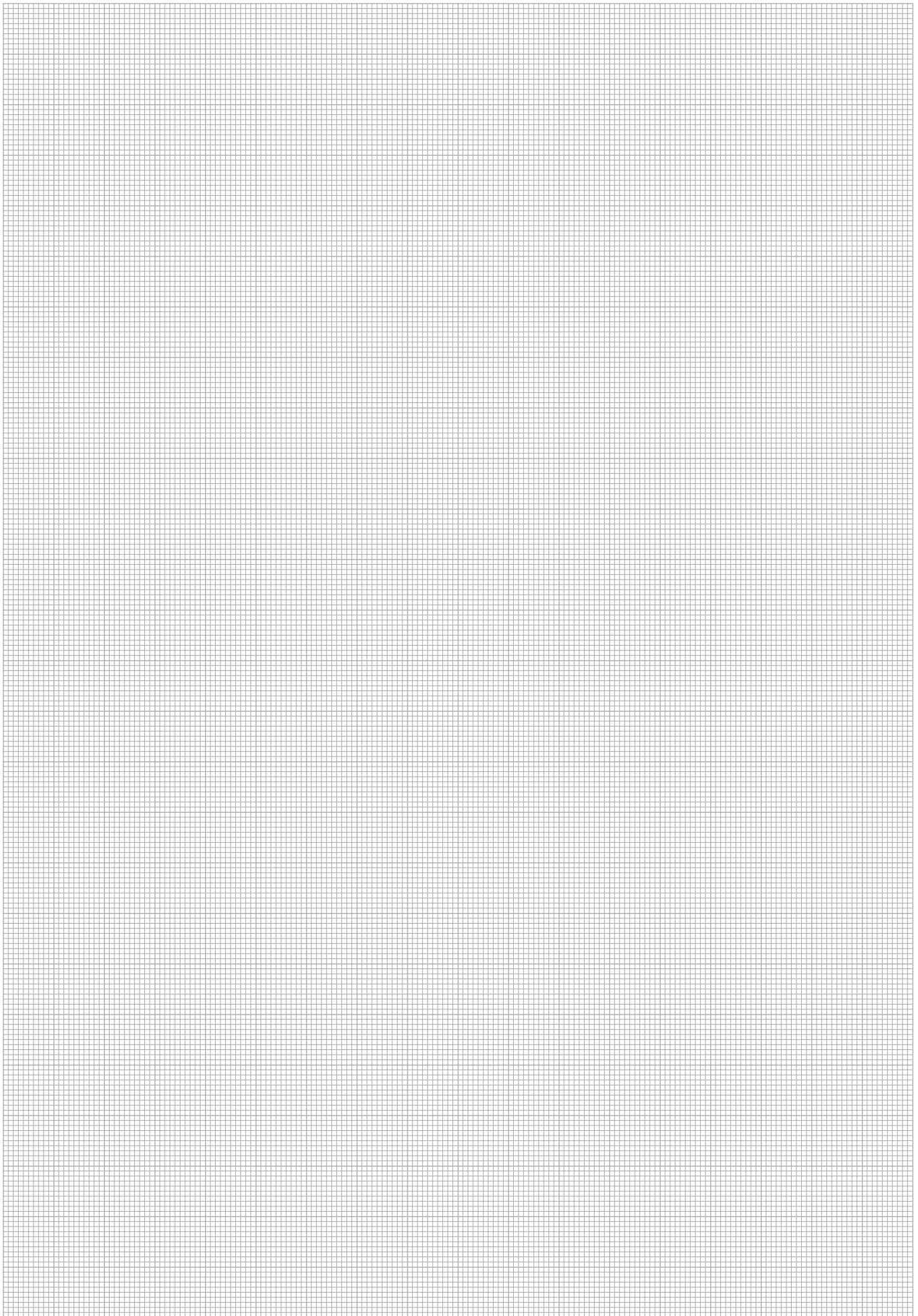

**Straight Male Stud Fitting**  
Type FI-GE-...-Rk • Series LL

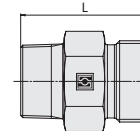
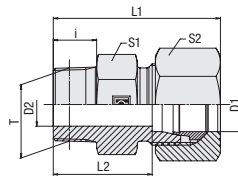

C

**Whitworth Taper Pipe Thread (BSPT)**

**Ordering Codes**

**\*FI-GE\*-10\*LL\*Rk\*-W3\*-MS**

- \* Straight Male Stud Fitting **FI-GE**
- \* Outside Tube Diameter D1 (in mm) **-10**
- \* Series **LL**  
 Extra-Light Series (page 60)  
 Light Series (page 61)  
 Heavy Series (page 62)
- \* Thread Type **Rk**  
 Whitworth Taper  
 Pipe Thread (BSPT)
- If required, please indicate special sizes, e.g. R1/8k!
- \* Material Code **-W3**  
 Steel, zinc/nickel-plated
- Please contact STAUFF for alternative materials and surface finishings.
- \* Assembling / Kitting **—**  
 Fitting body only
- Fitting body supplied with cutting ring and union nut **-MS**
- Fitting body supplied with soft-sealing cutting ring and union nut **-MSV**

Series	Tube OD		PN (PB)	Dimensions								Weight ( <sup>kg</sup> / <sub>lbs</sub> ) ca. per 100	Ordering Codes <sup>3</sup>
	(mm/in)	(bar/psi)		(mm/in)	Thread	T	D2	i	L	L1 <sup>1</sup>	L2		
LL	4	100	R 1/8 keg.	3	8	20	26	16	10	10	0,77	FI-GE-04LLRk-W3	
	.16	1450		.12	.31	.79	1.02	.63	.39	.39	1.70		
	6	100	R 1/8 keg.	4,5	8	20	26	14,5	11	12	0,79	FI-GE-06LLRk-W3	
	.24	1450		.18	.31	.79	1.02	.57	.43	.47	1.75		
	6	100	R 1/4 keg.	4,5	12	26	33	20,5	14	12	1,85	FI-GE-06LLR1/4k-W3	
	.24	1450		.18	.47	1.02	1.30	.81	.55	.47	4.08		
	8	100	R 1/8 keg.	4,5	8	22	28	16,5	12	14	1,08	FI-GE-08LLRk-W3	
	.31	1450		.18	.31	.87	1.10	.65	.47	.55	2.38		
	8	100	R 1/4 keg.	6	12	26	32	20,5	14	14	1,71	FI-GE-08LLR1/4k-W3	
	.31	1450		.24	.47	1.02	1.26	.81	.55	.55	3.77		
	10	100	R 1/4 keg.	8	12	26	32	20,5	14	17	2,70	FI-GE-10LLRk-W3	
	.39	1450		.31	.47	1.02	1.26	.81	.55	.67	5.94		
12	100	R 3/8 keg.	10	12	26	32,5	20	19	19	2,44	FI-GE-12LLR3/8k-W3		
.47	1450		.39	.47	1.02	1.28	.79	.75	.75	5.38			

**Connecting Parts**

- Cutting Ring  
Type **FI-DS** Page 28
- Soft-Sealing Cutting Ring  
Type **FI-WDDS** Page 29
- Support Sleeve  
Type **FI-VH** Page 31
- STAUFF Form EVO Sealing Ring  
Type **FI-FD** Page 32
- Union Nut  
Type **FI-M** Page 33
- 37° Flared Tube Fitting Set  
Type **FI-AB** Page 37

<sup>1</sup> Approximate dimension in assembled condition.

<sup>2</sup> Weight excluding cutting ring and union nut.

<sup>3</sup> Standard scope of delivery: Fitting body only.

Male stud acc. to DIN 3852-2 (Form C)  
 Port acc. to DIN 3852-2 (Form Z)  
 Suitable liquid / plastic sealant required.

Male threaded studs were designed for female threaded ports in components made of steel. For applications with components made of softer mating materials (e.g. Aluminium), the use of connectors with additionally rolled male threads is recommended.  
 Please contact STAUFF prior to the assembly for further information.



Straight Male Stud Fitting
Type FI-GE-...-Rk • Series L

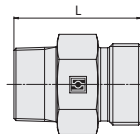
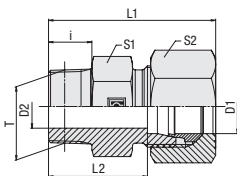

C

Whitworth Taper Pipe Thread (BSPT)

Table with columns: Series, Tube OD (mm/in), PN (PB) Dimensions (mm/in), Dimensions (D1, D2, i, L, L1, L2, S1, S2), Weight (kg/lbs) ca. per 100, and Ordering Codes.

Ordering Codes

\*FI-GE\*-10\*L\*Rk\*-W3\*-MS

Ordering code breakdown table with columns: \* Straight Male Stud Fitting (FI-GE), \* Outside Tube Diameter D1 (in mm) (-10), \* Series (LL, L, S), \* Thread Type (Rk), \* Material Code (-W3), \* Assembling / Kitting (MS, MSV).

Connecting Parts

Table of connecting parts: Cutting Ring Type FI-DS (Page 28), Soft-Sealing Cutting Ring Type FI-WDDS (Page 29), Support Sleeve Type FI-VH (Page 31), STAUFF Form EVO Sealing Ring Type FI-FD (Page 32), Union Nut Type FI-M (Page 33), 37° Flared Tube Fitting Set Type FI-AB (Page 37).

1 Approximate dimension in assembled condition.
2 Weight excluding cutting ring and union nut.
3 Standard scope of delivery: Fitting body only.

Male stud acc. to DIN 3852-2 (Form C)
Port acc. to DIN 3852-2 (Form Z)
Suitable liquid / plastic sealant required.

Male threaded studs were designed for female threaded ports in components made of steel. For applications with components made of softer mating materials (e.g. Aluminium), the use of connectors with additionally rolled male threads is recommended.
Please contact STAUFF prior to the assembly for further information.



**Straight Male Stud Fitting**  
Type FI-GE-...-Rk • Series S

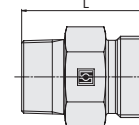
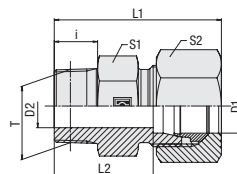

Whitworth Taper Pipe Thread (BSPT)

**Ordering Codes**

**\*FI-GE\*-10\*S\*Rk\*-W3\*-MS**

- \* Straight Male Stud Fitting **FI-GE**
- \* Outside Tube Diameter D1 (in mm) **-10**
- \* Series **LL**  
 Extra-Light Series (page 60)  
**L** Light Series (page 61)  
**S** Heavy Series (page 62)
- \* Thread Type **Rk**  
 Whitworth Taper  
 Pipe Thread (BSPT)
- If required, please indicate special sizes, e.g. R1/8k!
- \* Material Code **-W3**  
 Steel, zinc/nickel-plated
- Please contact STAUFF for alternative materials and surface finishings.
- \* Assembling / Kitting **—**  
 Fitting body only
- Fitting body supplied with cutting ring and union nut **-MS**
- Fitting body supplied with soft-sealing cutting ring and union nut **-MSV**

**Connecting Parts**

- Cutting Ring  
Type **FI-DS** Page 28
- Soft-Sealing Cutting Ring  
Type **FI-WDDS** Page 29
- Support Sleeve  
Type **FI-VH** Page 31
- STAUFF Form EVO Sealing Ring  
Type **FI-FD** Page 32
- Union Nut  
Type **FI-M** Page 33
- 37° Flared Tube Fitting Set  
Type **FI-AB** Page 37

Series	Tube OD (mm/in)	PB (bar/psi)	Dimensions (mm/in)								Weight (kg/lbs) ca. per 100	Ordering Codes <sup>3</sup>
			Thread	T	D2	i	L	L1 <sup>1</sup>	L2	S1		
S	6	630	R 1/4 keg.	4	12	30	38	23	17	17	3,01	FI-GE-06SRk-W3
	.24	9135		.16	.47	1.18	1.50	.91	.67	.67	6.62	
	8	630	R 1/4 keg.	5	12	29	37	22	17	19	3,50	FI-GE-08SRk-W3
	.31	9135		.20	.47	1.14	1.46	.87	.67	.75	7.69	
	10	630	R 3/8 keg.	7	12	32	41	24,5	19	22	4,49	FI-GE-10SRk-W3
	.39	9135		.28	.47	1.26	1.61	.96	.75	.87	9.88	
	12	630	R 3/8 keg.	8	12	34	43	26,5	22	24	6,03	FI-GE-12SRk-W3
	.47	9135		.31	.47	1.34	1.69	1.04	.87	.94	13.27	
	14	630	R 3/8 keg.	8	12	34,5	45	26,5	24	27	6,56	FI-GE-14SR3/8k-W3
	.55	9135		.31	.47	1.36	1.77	1.04	.94	1.06	14.46	
	14	630	R 1/2 keg.	10	14	35	45	27	24	27	7,04	FI-GE-14SRk-W3
	.55	9135		.39	.55	1.38	1.77	1.06	.94	1.06	15.48	
	16	400	R 3/8 keg.	9	12	32	47	23,5	27	30	6,13	FI-GE-16SR3/8k-W3
	.63	5800		.35	.47	1.26	1.85	.93	1.06	1.18	13.51	
	16	400	R 1/2 keg.	12	14	38	48	29,5	27	30	8,52	FI-GE-16SRk-W3
	.63	5800		.47	.55	1.50	1.89	1.16	1.06	1.18	18.75	
	20	400	R 3/4 keg.	16	17	45,5	57	35	32	36	14,43	FI-GE-20SRk-W3
	.79	5800		.63	.67	1.79	2.24	1.38	1.26	1.42	31.75	
	25	400	R 3/4 keg.	16	17	48	62,5	37	41	46	10,15	FI-GE-25SR3/4k-W3
	.98	5800		.63	.67	1.89	2.46	1.46	1.61	1.81	22.38	
25	400	R 1 keg.	20	18	49	63,5	37	41	46	25,81	FI-GE-25SRk-W3	
.98	5800		.79	.71	1.93	2.50	1.46	1.61	1.81	56,90		
30	400	R 1 keg.	20	18	52	67,5	39	50	50	31,78	FI-GE-30SR1k-W3	
1.18	5800		.79	.71	2.05	2.66	1.54	1.97	1.97	70,06		
30	250	R 1-1/4 keg.	25	20	54	69,5	41	50	50	36,69	FI-GE-30SRk-W3	
1.18	3626		.98	.79	2.13	2.74	1.61	1.97	1.97	80,89		
38	250	R 1 1/2 keg.	32	22	59	75	43	55	60	50,8	FI-GE-38SRk-W3	
1.50	3626		1.26	.87	2.32	2.95	1.69	2.17	2.36	111,99		

<sup>1</sup> Approximate dimension in assembled condition.

<sup>2</sup> Weight excluding cutting ring and union nut.

<sup>3</sup> Standard scope of delivery: Fitting body only.

Male stud acc. to DIN 3852-2 (Form C)

Port acc. to DIN 3852-2 (Form Z)

Suitable liquid / plastic sealant required.

Male threaded studs were designed for female threaded ports in components made of steel. For applications with components made of softer mating materials (e.g. Aluminium), the use of connectors with additionally rolled male threads is recommended.

Please contact STAUFF prior to the assembly for further information.



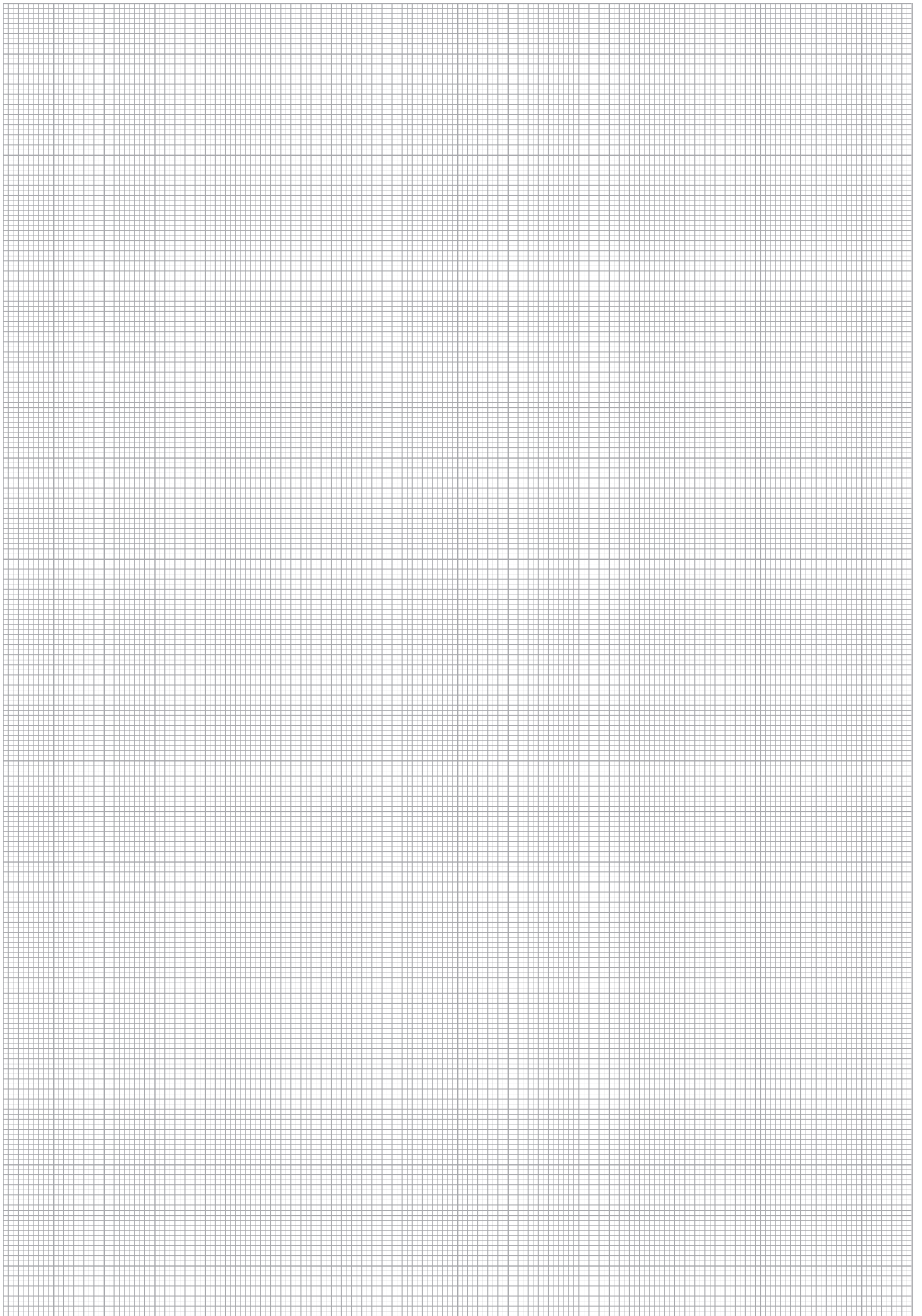

**Straight Male Stud Fitting**  
Type FI-GE-...-Mk ▪ Series LL / L

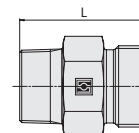
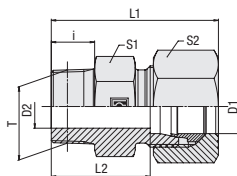

C

**Ordering Codes**

**\*FI-GE\*-10\*L\*Mk\*-W3\*-MS**

- \* Straight Male Stud Fitting **FI-GE**
- \* Outside Tube Diameter D1 (in mm) **-10**
- \* Series                   Extra-Light Series **LL**  
                                  Light Series **L**
- \* Thread Type           Metric Taper Thread **Mk**
- If required, please indicate special sizes, e.g. M16x1.5k!
- \* Material Code        Steel, zinc/nickel-plated **-W3**
- Please contact STAUFF for alternative materials and surface finishings.
- \* Assembling / Kitting   Fitting body only **—**
- Fitting body supplied with cutting ring and union nut **-MS**
- Fitting body supplied with soft-sealing cutting ring and union nut **-MSV**

**Connecting Parts**

- Cutting Ring  
Type **FI-DS**                   Page 28
- Soft-Sealing Cutting Ring  
Type **FI-WDDS**               Page 29
- Support Sleeve  
Type **FI-VH**                   Page 31
- STAUFF Form EVO Sealing Ring  
Type **FI-FD**                   Page 32
- Union Nut  
Type **FI-M**                    Page 33
- 37° Flared Tube Fitting Set  
Type **FI-AB**                   Page 37

**Metric Taper Thread**

Series	Tube OD		PN	Dimensions								Weight (% <sub>0</sub> /lbs) ca. per 100	Ordering Codes <sup>3</sup>
	(mm/in)	(bar/PSI)		(mm/in)	Thread	T	D2	i	L	L1 <sup>1</sup>	L2		
LL	4	100	M 6 x 1 keg.	2,5	8	20	26	16	9	10	0,50	FI-GE-04LLM6x1k-W3	
	.16	1450		.10	.31	.79	1.02	.63	.35	.39	1.09		
	4	100	M 8 x 1 keg.	3	8	20	26	16	10	10	0,63	FI-GE-04LLMk-W3	
	.16	1450		.12	.31	.79	1.02	.63	.39	.39	1.39		
	4	100	M 10 x 1 keg.	3	8	20	26	16	11	10	0,85	FI-GE-04LLM10x1k-W3	
	.16	1450		.12	.31	.79	1.02	.63	.43	.39	1.87		
	6	100	M 6 x 1 keg.	2	8	20	26	14,5	11	12	0,68	FI-GE-06LLM6x1k-W3	
	.24	1450		.08	.31	.79	1.02	.57	.43	.47	1.50		
	6	100	M 8 x 1 keg.	3	8	20	26	14,5	11	12	0,75	FI-GE-06LLM8x1k-W3	
	.24	1450		.12	.31	.79	1.02	.57	.43	.47	1.66		
	6	100	M 10 x 1 keg.	4	8	20	26	14,5	11	12	0,85	FI-GE-06LLMk-W3	
	.24	1450		.16	.31	.79	1.02	.57	.43	.47	1.88		
8	100	M 8 x 1 keg.	3,5	8	22	28	16,5	12	14	1,29	FI-GE-08LLM8x1k-W3		
.31	1450		.14	.31	.87	1.10	.65	.47	.55	2.83			
8	100	M 10 x 1 keg.	6	8	22	28	16,5	12	14	0,98	FI-GE-08LLMk-W3		
.31	1450		.24	.31	.87	1.10	.65	.47	.55	2.15			
L	6	315	M 10 x 1 keg.	4	8	23	31	16	14	14	1,44	FI-GE-06LMk-W3	
	.24	4568		.16	.31	.91	1.22	.63	.55	.55	3.17		
	6	315	M 12 x 1,5 keg.	4	12	27	35	20	14	14	1,56	FI-GE-06LM12x1.5k-W3	
	.24	4568		.16	.47	1.06	1.38	.79	.55	.55	3.44		
	8	315	M 12 x 1,5 keg.	6	12	27	35	20	14	17	1,74	FI-GE-08LMk-W3	
	.31	4568		.24	.47	1.06	1.38	.79	.55	.67	3.83		
	8	315	M 14 x 1,5 keg.	6	12	27	35	20	17	17	3,11	FI-GE-08LM14x1.5k-W3	
	.31	4568		.24	.47	1.06	1.38	.79	.67	.67	6.83		
	10	315	M 14 x 1,5 keg.	7	12	28	36	21	17	19	2,51	FI-GE-10LMk-W3	
	.39	4568		.28	.47	1.10	1.42	.83	.67	.75	5.53		
	10	315	M 16 x 1,5 keg.	8	12	28	36	21	17	19	4,05	FI-GE-10LM16x1.5k-W3	
	.39	4568		.31	.47	1.10	1.42	.83	.67	.75	8.91		
	12	315	M 16 x 1,5 keg.	9	12	29	37	22	19	22	3,18	FI-GE-12LMk-W3	
	.47	4568		.35	.47	1.14	1.46	.87	.75	.87	6.99		
	12	315	M 18 x 1,5 keg.	10	12	29	37	22	19	22	4,90	FI-GE-12LM18x1.5k-W3	
	.47	4568		.39	.47	1.14	1.46	.87	.75	.87	10.78		
	15	315	M 18 x 1,5 keg.	11	12	30	41	23	24	27	4,73	FI-GE-15LMk-W3	
	.59	4568		.43	.47	1.18	1.61	.91	.94	1.06	10.41		
18	315	M 22 x 1,5 keg.	14	14	33	42	25,5	27	32	7,02	FI-GE-18LMk-W3		
.71	4568		.55	.55	1.30	1.65	1.00	1.06	1.26	15.44			

<sup>1</sup> Approximate dimension in assembled condition.

<sup>2</sup> Weight excluding cutting ring and union nut.

<sup>3</sup> Standard scope of delivery: Fitting body only.

Male stud acc. to DIN 3852-1 (Form C)

Port acc. to DIN 3852-1 (Form Z)

Suitable liquid / plastic sealant required.

Male threaded studs were designed for female threaded ports in components made of steel. For applications with components made of softer mating materials (e.g. Aluminium), the use of connectors with additionally rolled male threads is recommended.

Please contact STAUFF prior to the assembly for further information.





Straight Male Stud Fitting  
Type FI-GE-...-N • Series LL / L

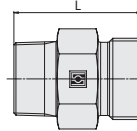
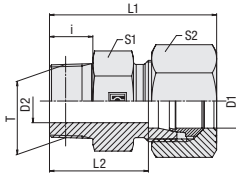

C

NPT Thread

Series	Tube OD (mm/in)	PN (bar/psi)	Dimensions (mm/in)								Weight (kg/lbs) ca. per 100	Ordering Codes <sup>3</sup>
			Thread	T	D2	i	L	L1 <sup>1</sup>	L2	S1		
LL	4	100	1/8 NPT	3	10	22	28	18	11	10	0,98	FI-GE-04LL1/8N-W3
	.16	1450		.12	.39	.87	1.10	.71	.43	.39	2.15	
	6	100	1/8 NPT	4,5	10	22	28	16,5	11	12	0,90	FI-GE-06LL1/8N-W3
	.24	1450		.18	.39	.87	1.10	.65	.43	.47	1.97	
	8	100	1/8 NPT	5	10	24	30	18,5	12	14	1,16	FI-GE-08LL1/8N-W3
.31	1450	.20		.39	.94	1.18	.73	.47	.55	2.55		
L	6	315	1/8 NPT	4	10	24	32	17	12	14	1,21	FI-GE-06L1/8N-W3
	.24	4568		.16	.39	.94	1.26	.67	.47	.55	2.66	
	6	315	1/4 NPT	4	15,5	30	38	23	17	14	2,63	FI-GE-06L1/4N-W3
	.24	4568		.16	.61	1.18	1.50	.91	.67	.55	5.79	
	6	315	3/8 NPT	4	15,5	31	39	24	19	14	4,01	FI-GE-06L3/8N-W3
	.24	4568		.16	.61	1.22	1.54	.94	.75	.55	8.82	
	6	315	1/2 NPT	4	20	36	44	29	22	14	5,62	FI-GE-06L1/2N-W3
	.24	4568		.16	.79	1.42	1.73	1.14	.87	.55	12.37	
	8	315	1/8 NPT	4	10	25	33	18	14	17	1,65	FI-GE-08L1/8N-W3
	.31	4568		.16	.39	.98	1.30	.71	.55	.67	3.63	
	8	315	1/4 NPT	6	15	30	38	23	17	17	2,49	FI-GE-08L1/4N-W3
	.31	4568		.24	.59	1.18	1.50	.91	.67	.67	5.48	
	8	315	3/8 NPT	6	15,5	30	38	23	19	17	3,70	FI-GE-08L3/8N-W3
	.31	4568		.24	.61	1.18	1.50	.91	.75	.67	8.14	
	8	315	1/2 NPT	6	20	36	44	29	22	17	6,78	FI-GE-08L1/2N-W3
	.31	4568		.24	.79	1.42	1.73	1.14	.87	.67	14.91	
	10	315	1/8 NPT	4	10	25	33	18	17	19	1,90	FI-GE-10L1/8N-W3
	.39	4568		.16	.39	.98	1.30	.71	.67	.75	4.18	
	10	315	1/4 NPT	7	15	31	39	24	17	19	2,53	FI-GE-10L1/4N-W3
	.39	4568		.28	.59	1.22	1.54	.94	.67	.75	5.57	
	10	315	3/8 NPT	7	15	32	40	25	19	19	3,97	FI-GE-10L3/8N-W3
	.39	4568		.28	.59	1.26	1.57	.98	.75	.75	8.73	
	10	315	1/2 NPT	7	20	37	45	30	22	19	6,99	FI-GE-10L1/2N-W3
	.39	4568		.28	.79	1.46	1.77	1.18	.87	.75	15.39	
	10	315	3/4 NPT	8	20	38	46	31	27	19	5,67	FI-GE-10L3/4N-W3
	.39	4568		.31	.79	1.50	1.81	1.22	1.06	.75	12.47	
	12	315	1/8 NPT	4	10	26	34	19	19	22	2,48	FI-GE-12L1/8N-W3
	.47	4568		.16	.39	1.02	1.34	.75	.75	.87	5.45	
	12	315	1/4 NPT	7	15	32	40	25	19	22	3,21	FI-GE-12L1/4N-W3
	.47	4568		.28	.59	1.26	1.57	.98	.75	.87	7.05	
12	315	3/8 NPT	8	15	32	40	25	19	22	3,95	FI-GE-12L3/8N-W3	
.47	4568		.31	.59	1.26	1.57	.98	.75	.87	8.69		
12	315	1/2 NPT	10	20	37	45	30	24	22	6,48	FI-GE-12L1/2N-W3	
.47	4568		.39	.79	1.46	1.77	1.18	.94	.87	14.25		
12	315	3/4 NPT	8	20	38	46	31	27	22	10,93	FI-GE-12L3/4N-W3	
.47	4568		.31	.79	1.50	1.81	1.22	1.06	.87	24.04		
15	315	1/4 NPT	7	15	33	41	26	24	27	4,72	FI-GE-15L1/4N-W3	
.59	4568		.28	.59	1.30	1.61	1.02	.94	1.06	10.38		
15	315	3/8 NPT	11	15,5	38	41	31	24	27	5,12	FI-GE-15L3/8N-W3	
.59	4568		.43	.61	1.50	1.61	1.22	.94	1.06	11.26		
15	315	1/2 NPT	12	20	38	46	31	24	27	6,44	FI-GE-15L1/2N-W3	
.59	4568		.47	.79	1.50	1.81	1.22	.94	1.06	14.16		
15	315	3/4 NPT	12	20	40	48	33	27	27	10,60	FI-GE-15L3/4N-W3	
.59	4568		.47	.79	1.57	1.89	1.30	1.06	1.06	23.31		

**Ordering Codes**

**\*FI-GE\*-10\*L\*1/4\*N\*-W3\*-MS**

- \* Straight Male Stud Fitting **FI-GE**
- \* Outside Tube Diameter D1 (in mm) **-10**
- \* Series Extra-Light Series (page 65) **LL**  
Light Series (pages 65/66) **L**  
Heavy Series (pages 67/68) **S**
- \* Thread Size acc. to dimension table **1/4**
- Please always indicate thread sizes, e.g. 1/4!
- \* Thread Type NPT Thread **N**
- \* Material Code Steel, zinc/nickel-plated **-W3**
- Please contact STAUFF for alternative materials and surface finishings.
- \* Assembling / Kitting Fitting body only **—**
- Fitting body supplied with cutting ring and union nut **-MS**
- Fitting body supplied with soft-sealing cutting ring and union nut **-MSV**

**Connecting Parts**

- Cutting Ring Type **FI-DS** Page 28
- Soft-Sealing Cutting Ring Type **FI-WDDS** Page 29
- Support Sleeve Type **FI-VH** Page 31
- STAUFF Form EVO Sealing Ring Type **FI-FD** Page 32
- Union Nut Type **FI-M** Page 33
- 37° Flared Tube Fitting Set Type **FI-AB** Page 37

<sup>1</sup> Approximate dimension in assembled condition.  
<sup>2</sup> Weight excluding cutting ring and union nut.  
<sup>3</sup> Standard scope of delivery: Fitting body only.

Male stud acc. to ANSI/ASME B1.20.1-1983  
 Port acc. to ANSI/ASME B1.20.1-1983

Suitable liquid / plastic sealant required.

Male threaded studs were designed for female threaded ports in components made of steel. For applications with components made of softer mating materials (e.g. Aluminium), the use of connectors with additionally rolled male threads is recommended.  
 Please contact STAUFF prior to the assembly for further information.



**Straight Male Stud Fitting**  
Type FI-GE-...-N • Series L

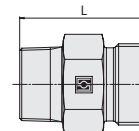
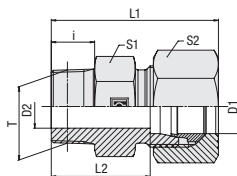

C

**NPT Thread**

**Ordering Codes**

**\*FI-GE\*-10\*L\*1/4\*N\*-W3\*-MS**

- \* Straight Male Stud Fitting **FI-GE**
- \* Outside Tube Diameter D1 (in mm) **-10**
- \* Series **LL** Extra-Light Series (page 65)  
**L** Light Series (pages 65/66)  
**S** Heavy Series (pages 67/68)
- \* Thread Size **1/4** acc. to dimension table  
Please always indicate thread sizes, e.g. 1/4!
- \* Thread Type **N** NPT Thread
- \* Material Code **-W3** Steel, zinc/nickel-plated  
Please contact STAUFF for alternative materials and surface finishings.
- \* Assembling / Kitting **—** Fitting body only  
**-MS** Fitting body supplied with cutting ring and union nut  
**-MSV** Fitting body supplied with soft-sealing cutting ring and union nut

Series	Tube OD		PN	Dimensions								Weight (kg/lbs) ca. per 100	Ordering Codes <sup>3</sup>
	(mm/in)	(mm/in)		(mm/in)	Thread T	D2	i	L	L1 <sup>1</sup>	L2	S1		
L	18	315	3/8 NPT	8	15,5	34	43	26,5	27	32	6,78	FI-GE-18L3/8N-W3	
	.71	4568		.31	.61	1.34	1.69	1.04	1.06	1.26	14.92		
	18	315	1/2 NPT	12	20	39	48	31,5	27	32	8,10	FI-GE-18L1/2N-W3	
	.71	4568		.47	.79	1.54	1.89	1.24	1.06	1.26	17.82		
	18	315	3/4 NPT	15	20	39	48	31,5	27	32	10,51	FI-GE-18L3/4N-W3	
	.71	4568		.59	.79	1.54	1.89	1.24	1.06	1.26	23.12		
	18	315	1 NPT	15	25	45	54	37,5	36	32	16,85	FI-GE-18L1N-W3	
	.71	4568		.59	.98	1.77	2.13	1.48	1.42	1.26	37.08		
	22	160	1/2 NPT	14	20	41	50	33,5	32	36	9,26	FI-GE-22L1/2N-W3	
	.87	2320		.55	.79	1.61	1.97	1.32	1.26	1.42	20.37		
	22	160	3/4 NPT	16	20	41	50	33,5	32	36	11,07	FI-GE-22L3/4N-W3	
	.87	2320		.63	.79	1.61	1.97	1.32	1.26	1.42	24.35		
22	160	1 NPT	19	25	47	56	39,5	36	36	18,05	FI-GE-22L1N-W3		
.87	2320		.75	.98	1.85	2.20	1.56	1.42	1.42	39.70			
28	160	3/4 NPT	18	20	42	51	34,5	41	41	18,00	FI-GE-28L3/4N-W3		
1.10	2320		.71	.79	1.65	2.01	1.36	1.61	1.61	39.60			
28	160	1 NPT	21	25	47	56	39,5	41	41	19,89	FI-GE-28L1N-W3		
1.10	2320		.83	.98	1.85	2.20	1.56	1.61	1.61	43.76			
28	160	1 1/4 NPT	24	26	49	58	41,5	46	41	27,00	FI-GE-28L1-1/4N-W3		
1.10	2320		.94	1.02	1.93	2.28	1.63	1.81	1.61	59.40			
35	160	1 NPT	21	21	46	57	40,5	46	50	24,03	FI-GE-35L1N-W3		
1.38	2320		.83	.83	1.81	2.24	1.59	1.81	1.97	52.98			
35	160	1 1/4 NPT	28	26	51	62	40,5	46	50	39,59	FI-GE-35L1-1/4N-W3		
1.38	2320		1.10	1.02	2.01	2.44	1.59	1.81	1.97	87.09			
42	160	1 1/4 NPT	28	26	53	65	42	55	60	35,36	FI-GE-42L1-1/4N-W3		
1.65	2320		1.10	1.02	2.09	2.56	1.65	2.17	2.36	77.79			
42	160	1 1/2 NPT	36	26	53	65	42	55	60	35,36	FI-GE-42L1-1/2N-W3		
1.65	2320		1.42	1.02	2.09	2.56	1.65	2.17	2.36	77.79			

**Connecting Parts**

- Cutting Ring  
Type **FI-DS** Page 28
- Soft-Sealing Cutting Ring  
Type **FI-WDDS** Page 29
- Support Sleeve  
Type **FI-VH** Page 31
- STAUFF Form EVO Sealing Ring  
Type **FI-FD** Page 32
- Union Nut  
Type **FI-M** Page 33
- 37° Flared Tube Fitting Set  
Type **FI-AB** Page 37

<sup>1</sup> Approximate dimension in assembled condition.  
<sup>2</sup> Weight excluding cutting ring and union nut.  
<sup>3</sup> Standard scope of delivery: Fitting body only.

Male stud acc. to ANSI/ASME B1.20.1-1983  
Port acc. to ANSI/ASME B1.20.1-1983

Suitable liquid / plastic sealant required.

Male threaded studs were designed for female threaded ports in components made of steel. For applications with components made of softer mating materials (e.g. Aluminium), the use of connectors with additionally rolled male threads is recommended.  
Please contact STAUFF prior to the assembly for further information.



Straight Male Stud Fitting  
Type FI-GE-...-N • Series S

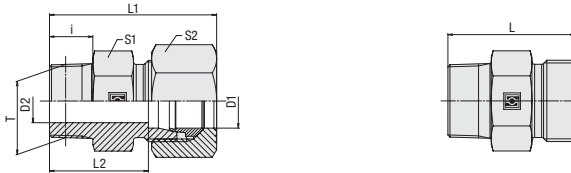

C

NPT Thread

Series	Tube OD (mm/in)	PN (bar/PSI)	Dimensions (mm/in)									Weight (kg/lbs) ca. per 100	Ordering Codes <sup>3</sup>
			Thread	T	D2	i	L	L1 <sup>1</sup>	L2	S1	S2		
S	6	630	1/8 NPT	4	10	28	36	21	14	17	2,30	FI-GE-06S1/8N-W3	
	.24	9135		.16	.39	1.10	1.42	.83	.55	.67	5.06		
6	630	9135	1/4 NPT	4	15	35	43	28	17	17	3,71	FI-GE-06S1/4N-W3	
	.24			.16	.59	1.38	1.69	1.10	.67	.67	8.17		
6	630	9135	3/8 NPT	4	15,5	33	41	26	19	17	4,50	FI-GE-06S3/8N-W3	
	.24			.16	.61	1.30	1.61	1.02	.75	.67	9.91		
6	630	9135	1/2 NPT	12	20	38	45	30,5	22	17	8,8	FI-GE-06S1/2N-W3	
	.24			.47	.79	1.50	1.77	1.20	.87	.67	19.40		
8	630	9135	1/8 NPT	4	10	29,5	37,5	22,5	17	19	3,20	FI-GE-08S1/8N-W3	
	.31			.16	.39	1.16	1.48	.89	.67	.75	7.04		
8	630	9135	1/4 NPT	5	15	35	43	28	17	19	3,81	FI-GE-08S1/4N-W3	
	.31			.20	.59	1.38	1.69	1.10	.67	.75	8.37		
8	630	9135	3/8 NPT	5	15,5	36	44	29	19	19	5,31	FI-GE-08S3/8N-W3	
	.31			.20	.61	1.42	1.73	1.14	.75	.75	11.68		
8	630	9135	1/2 NPT	5	20	40	48	33	22	19	8,17	FI-GE-08S1/2N-W3	
	.31			.20	.79	1.57	1.89	1.30	.87	.75	17.97		
10	630	9135	1/4 NPT	5	15	35	44	27,5	19	22	4,36	FI-GE-10S1/4N-W3	
	.39			.20	.59	1.38	1.73	1.08	.75	.87	9.59		
10	630	9135	3/8 NPT	7	15	35	44	27,5	19	22	4,95	FI-GE-10S3/8N-W3	
	.39			.28	.59	1.38	1.73	1.08	.75	.87	10.89		
10	630	9135	1/2 NPT	7	20	38	47	30,5	22	22	7,32	FI-GE-10S1/2N-W3	
	.39			.28	.79	1.50	1.85	1.20	.87	.87	16.11		
12	630	9135	1/4 NPT	5	15	37	46	29,5	22	24	4,84	FI-GE-12S1/4N-W3	
	.47			.20	.59	1.46	1.81	1.16	.87	.94	10.66		
12	630	9135	3/8 NPT	8	15	37	46	29,5	22	24	6,21	FI-GE-12S3/8N-W3	
	.47			.31	.59	1.46	1.81	1.16	.87	.94	13.67		
12	630	9135	1/2 NPT	8	20	42	51	34,5	22	24	8,52	FI-GE-12S1/2N-W3	
	.47			.31	.79	1.65	2.01	1.36	.87	.94	18.74		
12	630	9135	3/4 NPT	8	20	44	53	36,5	30	24	12,38	FI-GE-12S3/4N-W3	
	.47			.31	.79	1.73	2.09	1.44	1.18	.94	27.23		
14	630	9135	3/8 NPT	8	15,5	39	49	31	24	27	7,32	FI-GE-14S3/8N-W3	
	.55			.31	.61	1.54	1.93	1.22	.94	1.06	16.11		
14	630	9135	1/2 NPT	10	20	44	54	36	24	27	6,76	FI-GE-14S1/2N-W3	
	.55			.39	.79	1.73	2.13	1.42	.94	1.06	14.88		
14	630	9135	3/4 NPT	16	20	46	56	38	32	27	15,36	FI-GE-14S3/4N-W3	
	.55			.63	.79	1.81	2.20	1.50	1.26	1.06	33.86		
16	400	5800	3/8 NPT	8	15	39	49	30,5	27	30	8,66	FI-GE-16S3/8N-W3	
	.63			.31	.59	1.54	1.93	1.20	1.06	1.18	19.06		
16	400	5800	1/2 NPT	12	20	44	54	35,5	27	30	4,42	FI-GE-16S1/2N-W3	
	.63			.47	.79	1.73	2.13	1.40	1.06	1.18	9.72		
16	400	5800	3/4 NPT	12	20	45	55	36,5	30	30	13,97	FI-GE-16S3/4N-W3	
	.63			.47	.79	1.77	2.17	1.44	1.18	1.18	30.73		

### Ordering Codes

**\*FI-GE\*-10\*S\*1/4\*N\*-W3\*-MS**

- \* Straight Male Stud Fitting **FI-GE**
- \* Outside Tube Diameter D1 (in mm) **-10**
- \* Series  
 Extra-Light Series (page 65) **LL**  
 Light Series (pages 65/66) **L**  
 Heavy Series (pages 67/68) **S**
- \* Thread Size acc. to dimension table **1/4**
- Please always indicate thread sizes, e.g. 1/4!
- \* Thread Type NPT Thread **N**
- \* Material Code Steel, zinc/nickel-plated **-W3**
- Please contact STAUFF for alternative materials and surface finishings.
- \* Assembling / Kitting Fitting body only **—**
- Fitting body supplied with cutting ring and union nut **-MS**
- Fitting body supplied with soft-sealing cutting ring and union nut **-MSV**

### Connecting Parts

- Cutting Ring  
Type **FI-DS** Page 28
- Soft-Sealing Cutting Ring  
Type **FI-WDDS** Page 29
- Support Sleeve  
Type **FI-VH** Page 31
- STAUFF Form EVO Sealing Ring  
Type **FI-FD** Page 32
- Union Nut  
Type **FI-M** Page 33
- 37° Flared Tube Fitting Set  
Type **FI-AB** Page 37

<sup>1</sup> Approximate dimension in assembled condition.  
<sup>2</sup> Weight excluding cutting ring and union nut.  
<sup>3</sup> Standard scope of delivery: Fitting body only.

Male stud acc. to ANSI/ASME B1.20.1-1983  
 Port acc. to ANSI/ASME B1.20.1-1983

Suitable liquid / plastic sealant required.

Male threaded studs were designed for female threaded ports in components made of steel. For applications with components made of softer mating materials (e.g. Aluminium), the use of connectors with additionally rolled male threads is recommended.

Please contact STAUFF prior to the assembly for further information.



**Straight Male Stud Fitting**  
Type FI-GE-...-N • Series S

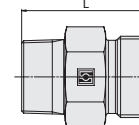
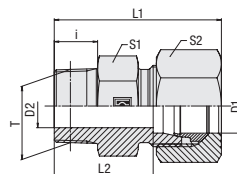

NPT Thread

**Ordering Codes**

**\*FI-GE\*-10\*S\*1/4\*N\*-W3\*-MS**

- \* Straight Male Stud Fitting **FI-GE**
- \* Outside Tube Diameter D1 (in mm) **-10**
- \* Series                   Extra-Light Series (page 65) **LL**  
                                  Light Series (pages 65/66) **L**  
                                  Heavy Series (pages 67/68) **S**
- \* Thread Size           acc. to dimension table **1/4**
- Please always indicate thread sizes, e.g. 1/4!
- \* Thread Type           NPT Thread **N**
- \* Material Code         Steel, zinc/nickel-plated **-W3**
- Please contact STAUFF for alternative materials and surface finishings.
- \* Assembling / Kitting   Fitting body only **—**
- Fitting body supplied with cutting ring and union nut **-MS**
- Fitting body supplied with soft-sealing cutting ring and union nut **-MSV**

**Connecting Parts**

-  Cutting Ring  
Type **FI-DS**                   Page 28
-  Soft-Sealing Cutting Ring  
Type **FI-WDDS**               Page 29
-  Support Sleeve  
Type **FI-VH**                   Page 31
-  STAUFF Form EVO Sealing Ring  
Type **FI-FD**                   Page 32
-  Union Nut  
Type **FI-M**                    Page 33
-  37° Flared Tube Fitting Set  
Type **FI-AB**                   Page 37

Series	Tube OD (mm/in)	PN (bar/psi)	Dimensions (mm/in)								Weight (kg/lbs) Ca. per 100	Ordering Codes <sup>3</sup>
			Thread	T	D2	i	L	L1 <sup>1</sup>	L2	S1		
S	20	400	1/2 NPT	12	20	48	59	37,5	32	36	12,18	FI-GE-20S1/2N-W3
	.79	5800		.47	.79	1.89	2.32	1.48	1.26	1.42	26.80	
	20	400	3/4 NPT	16	20	48	59	37,5	32	36	15,05	FI-GE-20S3/4N-W3
	.79	5800		.63	.79	1.89	2.32	1.48	1.26	1.42	33.12	
	20	400	1 NPT	16	25	55	66	44,5	36	36	25,37	FI-GE-20S1N-W3
	.79	5800		.63	.98	2.17	2.60	1.75	1.42	1.42	55.81	
	25	400	1/2 NPT	20	20	57	59	45	41	46	30,60	FI-GE-25S1/2N-W3
	.98	5800		.79	.79	2.24	2.32	1.77	1.61	1.81	67.32	
	25	400	3/4 NPT	16	20	52	64	40	41	46	23,86	FI-GE-25S3/4N-W3
	.98	5800		.63	.79	2.05	2.52	1.57	1.61	1.81	52.48	
	25	400	1 NPT	20	25	57	69	45	41	46	28,19	FI-GE-25S1N-W3
	.98	5800		.79	.98	2.24	2.72	1.77	1.61	1.81	62.01	
	25	400	1 1/4 NPT	20	26	58	70	46	46	46	47,00	FI-GE-25S1-1/4N-W3
	.98	5800		.79	1.02	2.28	2.76	1.81	1.81	1.81	103.40	
	30	400	3/4 NPT	16	20	54	67	40,5	46	50	31,29	FI-GE-30S3/4N-W3
	1.18	5800		.63	.79	2.13	2.64	1.59	1.81	1.97	68.98	
	30	400	1 NPT	20	25	59	72	45,5	46	50	34,70	FI-GE-30S1N-W3
	1.18	5800		.79	.98	2.32	2.83	1.79	1.81	1.97	76.34	
	30	400	1 1/4 NPT	25	26	60	73	46,5	46	50	36,50	FI-GE-30S1-1/4N-W3
	1.18	5800		.98	1.02	2.36	2.87	1.83	1.81	1.97	80.30	
30	400	1 1/2 NPT	25	26	60	73	46,5	50	50	36,50	FI-GE-30S1-1/2N-W3	
1.18	5800		.98	1.02	2.36	2.87	1.83	1.97	1.97	80.30		
38	315	1 NPT	20	25	64	79	48	55	60	53,6	FI-GE-38S1N-W3	
1.50	4568		.79	.98	2.52	3.11	1.89	2.17	2.36	118.17		
38	315	1 1/4 NPT	25	26	65	80	49	55	60	50,70	FI-GE-38S1-1/4N-W3	
1.50	4568		.98	1.02	2.56	3.15	1.93	2.17	2.36	111.54		
38	315	1 1/2 NPT	32	26	65	80	49	55	60	50,70	FI-GE-38S1-1/2N-W3	
1.50	4568		1.26	1.02	2.56	3.15	1.93	2.17	2.36	111.54		

<sup>1</sup> Approximate dimension in assembled condition.

<sup>2</sup> Weight excluding cutting ring and union nut.

<sup>3</sup> Standard scope of delivery: Fitting body only.

Male stud acc. to ANSI/ASME B1.20.1-1983

Port acc. to ANSI/ASME B1.20.1-1983

Suitable liquid / plastic sealant required.

Male threaded studs were designed for female threaded ports in components made of steel. For applications with components made of softer mating materials (e.g. Aluminium), the use of connectors with additionally rolled male threads is recommended.

Please contact STAUFF prior to the assembly for further information.



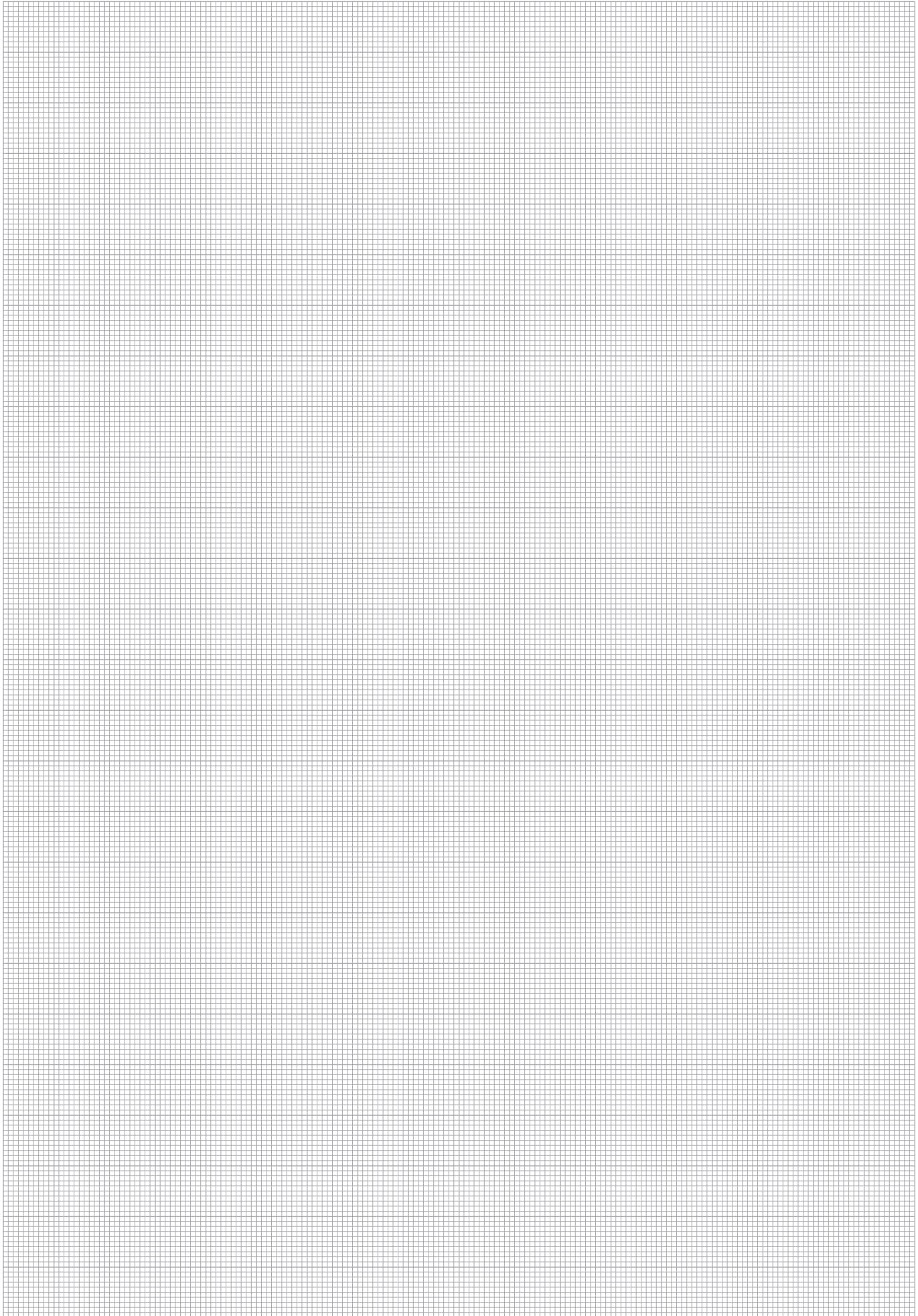

**Straight Male Stud Fitting**  
Type FI-GE-...-U • Series L

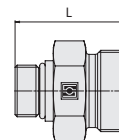
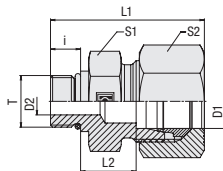

C

UN/UNF Thread

O-Ring

**Ordering Codes**

**\*FI-GE\*-10\*L\*3/4\*U\*-B\*-W3\*-MS**

- \* Straight Male Stud Fitting **FI-GE**
- \* Outside Tube Diameter D1 (in mm) **-10**
- \* Series Light Series (pages 70/71) **L**  
Heavy Series (page 71) **S**
- \* Thread Size acc. to dimension table **3/4**  
Please always indicate thread sizes, e.g. 3/4!
- \* Thread Type UN/UNF Thread with O-Ring **U**
- \* Seal Material NBR (Buna-N®) **-B**  
FKM (Viton®) **-V**  
EPDM **-E**
- \* Material Code Steel, zinc/nickel-plated **-W3**  
Please contact STAUFF for alternative materials and surface finishings.
- \* Assembling / Kitting Fitting body only **—**  
Fitting body supplied with cutting ring and union nut **-MS**  
Fitting body supplied with soft-sealing cutting ring and union nut **-MSV**

Bau-reihe	Rohr-Ø (mm/in)	PN (bar/PSI)	Abmessungen (mm/in)										Drehm. (N·m/ft·lb)	Gewicht (kg/lbs) ca.	Bestellbezeichnungen <sup>3</sup>
			Gewinde T	D2	i	L	L1 <sup>1</sup>	L2	S1	S2	Gewinde T	per 100			
L	6	400	7/16-20 UNF	4	9	26	34	10	17	14	18	2,08	FI-GE-06L7/16U-B-W3		
	.24	5800		.16	.35	1.02	1.34	.39	.67	.55	13.3	4.57			
	6	400	9/16-18 UNF	4	10	27	35	10	19	14	30	2,47	FI-GE-06L9/16U-B-W3		
	.24	5800		.16	.39	1.06	1.38	.39	.75	.55	22.1	5.44			
	8	400	7/16-20 UNF	4,5	9	26	34	10	17	17	18	2,18	FI-GE-08L7/16U-B-W3		
	.31	5800		.18	.35	1.02	1.34	.39	.67	.67	13.3	4.79			
	8	400	1/2-20 UNF	6	9	26	34	10	17	17	28	2,21	FI-GE-08L1/2U-B-W3		
	.31	5800		.24	.35	1.02	1.34	.39	.67	.67	20.6	4.87			
	8	400	9/16-18 UNF	6	10	27	35	10	19	17	30	2,76	FI-GE-08L9/16U-B-W3		
	.31	5800		.24	.39	1.06	1.38	.39	.75	.67	22.1	6.06			
	10	400	7/16-20 UNF	4,5	9	27	35	11	17	19	18	2,17	FI-GE-10L7/16U-B-W3		
	.39	5800		.18	.35	1.06	1.38	.43	.67	.75	13.3	4.78			
	10	400	9/16-18 UNF	7,5	10	28	36	11	19	19	30	2,70	FI-GE-10L9/16U-B-W3		
	.39	5800		.30	.39	1.10	1.42	.43	.75	.75	22.1	5.94			
	10	400	3/4-16 UNF	8	11	31	39	13	24	19	50	5,21	FI-GE-10L3/4U-B-W3		
	.39	5800		.31	.43	1.22	1.54	.51	.94	.75	37.0	11.47			
	12	400	7/16-20 UNF	4,5	9	28	35	12	19	22	18	2,77	FI-GE-12L7/16U-B-W3		
	.47	5800		.18	.35	1.10	1.38	.47	.75	.87	13.3	6.11			
	12	400	9/16-18 UNF	7,5	10	28	36	11	19	22	30	3,00	FI-GE-12L9/16U-B-W3		
	.47	5800		.30	.39	1.10	1.42	.43	.75	.87	22.1	6.61			
	12	400	3/4-16 UNF	10	11	31	39	13	24	22	50	4,89	FI-GE-12L3/4U-B-W3		
	.47	5800		.39	.43	1.22	1.54	.51	.94	.87	37.0	10.75			
	12	400	7/8-14 UNF	10	12,7	34	42	14,3	27	22	60	7,48	FI-GE-12L7/8U-B-W3		
	.47	5800		.39	.50	1.34	1.65	.56	1.06	.87	44.4	16.46			
	15	400	9/16-18UNF	7,5	10	31	40	14	24	27	30	4,79	FI-GE-15L9/16U-B-W3		
	.59	5800		.3	.39	1.22	1.57	.55	.94	1.06	22.1	10.56			
	15	400	3/4-16 UNF	10	11	32	40	14	24	27	50	2,40	FI-GE-15L3/4U-B-W3		
	.59	5800		.39	.43	1.26	1.57	.55	.94	1.06	37.0	5.29			
	15	400	7/8-14 UNF	12	12,7	34,7	42,7	15	27	27	60	7,41	FI-GE-15L7/8U-B-W3		
	.59	5800		.47	.50	1.37	1.68	.59	1.06	1.06	44.4	16.30			
	15	400	1-1/16-12UNF	15	15	39	47	16,5	32	27	95	11,19	FI-GE-15L1-1/16U-B-W3		
	.59	5800		.59	.59	1.54	1.85	.65	1.26	1.06	70.1	24.67			

**Connecting Parts**

- Cutting Ring Type **FI-DS** Page 28
- Soft-Sealing Cutting Ring Type **FI-WDDS** Page 29
- Support Sleeve Type **FI-VH** Page 31
- STAUFF Form EVO Sealing Ring Type **FI-FD** Page 32
- Union Nut Type **FI-M** Page 33
- 37° Flared Tube Fitting Set Type **FI-AB** Page 37

**Spare Parts / Accessories**

- O-Ring Type **O-RING** Page 239

<sup>1</sup> Approximate dimension in assembled condition.  
<sup>2</sup> Weight excluding cutting ring and union nut.  
<sup>3</sup> Standard scope of delivery: Fitting body only.

Male stud acc. to ISO 11926-2/-3  
 Port acc. to ISO 11926-1

Torque recommendations for Steel mating material.

Standard seal material is NBR (Buna-N®).

Male threaded studs were designed for female threaded ports in components made of steel. For applications with components made of softer mating materials (e.g. Aluminium), the use of connectors with additionally rolled male threads is recommended.  
 Please contact STAUFF prior to the assembly for further information.



Straight Male Stud Fitting  
Type FI-GE-...-U • Series L

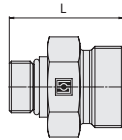
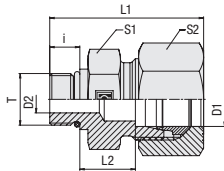

C

UN/UNF Thread

O-Ring

Bau- reihe	Rohr-Ø (mm/in)	PN (bar/psi)	Abmessungen (mm/in)	Drehm. Gewicht										Bestellbezeichnungen <sup>3</sup>
				Gewinde T	D2	i	L	L1 <sup>1</sup>	L2	S1	S2	Gewinde T	per 100	
L	18	400	3/4-16 UNF	10	11	33	42	14,5	27	32	50	6,86	FI-GE-18L3/4U-B-W3	
	.71	5800		.39	.43	1.30	1.65	.57	1.06	1.26	37.0	15.09		
	18	400	7/8-14 UNF	12,5	12,7	34,7	43,7	14,5	27	32	60	7,36	FI-GE-18L7/8U-B-W3	
	.71	5800		.49	.50	1.37	1.72	.57	1.06	1.26	44.4	16.19		
	18	400	1 1/16-12 UNF	15	15	37	45	14,5	32	32	95	11,04	FI-GE-18L1-1/16U-B-W3	
	.71	5800		.59	.59	1.46	1.77	.57	1.26	1.26	70.1	24.34		
	18	250	1 5/16-12 UNF	21,5	15	15,5	47	15,5	41	32	150	16,08	FI-GE-18L1-5/16U-B-W3	
	.71	3625		.85	.59	.61	1.85	.61	1.61	1.26	111.0	35.45		
	22	250	7/8-14 UNF	12,5	12,7	37	46	16,8	32	36	60	9,44	FI-GE-22L7/8U-B-W3	
	.87	3625		.49	.50	1.46	1.81	.66	1.26	1.42	44.4	20.78		
	22	250	1 1/16-12 UN	18	15	39	48	16,5	32	36	95	10,50	FI-GE-22L1-1/16U-B-W3	
	.87	3625		.71	.59	1.54	1.89	.65	1.26	1.42	70.3	23.10		
	22	250	1 5/16-12 UN	19	15	40	49	17,5	41	36	150	18,00	FI-GE-22L1-5/16U-B-W3	
	.87	3625		.75	.59	1.57	1.93	.69	1.61	1.42	111.0	39.60		
	28	250	7/8-14 UNF	12,5	12,7	37,7	45,7	17,5	41	41	60	14,09	FI-GE-28L7/8U-B-W3	
	1.10	3625		.49	.50	1.48	1.80	.69	1.61	1.61	44.4	31.01		
	28	250	1 1/16-12 UN	15	15	40	49	17,5	41	41	95	15,30	FI-GE-28L1-1/16U-B-W3	
	1.10	3625		.59	.59	1.57	1.93	.69	1.61	1.61	70.3	33.66		
	28	250	1 5/16-12 UN	21,5	15	40	49	17,5	41	41	150	17,20	FI-GE-28L1-5/16U-B-W3	
	1.10	3625		.85	.59	1.57	1.93	.69	1.61	1.61	111.0	38.84		
	28	250	1 5/8-12 UN	27,5	15	40	51	17,5	50	41	200	24,51	FI-GE-28L1-5/8U-B-W3	
	1.10	3625		1.08	.59	1.57	2.01	.69	1.97	1.61	148.0	54.04		
	35	250	1 5/16-12 UN	21,5	15	43	54	17,5	46	50	150	22,80	FI-GE-35L1-5/16U-B-W3	
	1.38	3625		.85	.59	1.69	2.13	.69	1.81	1.97	111.0	50.16		
	35	250	1 5/8-12 UN	27,5	15	43	54	17,5	50	50	200	28,00	FI-GE-35L1-5/8U-B-W3	
	1.38	3625		1.08	.59	1.69	2.13	.69	1.97	1.97	148.0	61.60		
	35	250	1 7/8-12 UN	30	15	45	57	19,5	55	50	325	31,2	FI-GE-35L1-7/8U-B-W3	
	1.38	3625		1.18	.59	1.77	2.24	.77	2.17	1.97	239.7	68.78		
	42	250	1 5/8-12 UN	27,5	15	45	57	19	55	60	200	35,36	FI-GE-42L1-5/8U-B-W3	
	1.65	3625		1.08	.59	1.77	2.24	.75	2.17	2.36	148.0	77.79		
	42	250	1 7/8-12 UN	33,5	15	45	57	19	55	60	325	35,5	FI-GE-42L1-7/8U-B-W3	
	1.65	3625		1.32	.59	1.77	2.24	.75	2.17	2.36	239.7	78.26		

<sup>1</sup> Approximate dimension in assembled condition.

<sup>2</sup> Weight excluding cutting ring and union nut.

<sup>3</sup> Standard scope of delivery: Fitting body only.

Male stud acc. to ISO 11926-2/-3

Port acc. to ISO 11926-1

Torque recommendations for Steel mating material.

Standard seal material is NBR (Buna-N®).

Male threaded studs were designed for female threaded ports in components made of steel. For applications with components made of softer mating materials (e.g. Aluminium), the use of connectors with additionally rolled male threads is recommended.

Please contact STAUFF prior to the assembly for further information.

### Ordering Codes

**\*FI-GE\*-10\*L\*3/4\*U\*-B\*-W3\*-MS**

- \* Straight Male Stud Fitting **FI-GE**
- \* Outside Tube Diameter D1 (in mm) **-10**
- \* Series Light Series (pages 70/71) **L**  
Heavy Series (page 71) **S**
- \* Thread Size acc. to dimension table **3/4**

Please always indicate thread sizes, e.g. 3/4!

- \* Thread Type UN/UNF Thread with O-Ring **U**
- \* Seal Material NBR (Buna-N®) **-B**  
FKM (Viton®) **-V**  
EPDM **-E**
- \* Material Code Steel, zinc/nickel-plated **-W3**

Please contact STAUFF for alternative materials and surface finishings.

- \* Assembling / Kitting Fitting body only **—**
- Fitting body supplied with cutting ring and union nut **-MS**
- Fitting body supplied with soft-sealing cutting ring and union nut **-MSV**

### Connecting Parts

- Cutting Ring Type **FI-DS** Page 28
- Soft-Sealing Cutting Ring Type **FI-WDDS** Page 29
- Support Sleeve Type **FI-VH** Page 31
- STAUFF Form EVO Sealing Ring Type **FI-FD** Page 32
- Union Nut Type **FI-M** Page 33
- 37° Flared Tube Fitting Set Type **FI-AB** Page 37

### Spare Parts / Accessories

- O-Ring Type **O-RING** Page 239



### Straight Male Stud Fitting Type FI-GE-...-U • Series S

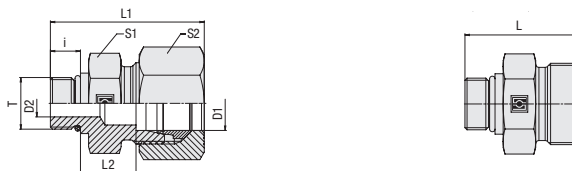

C

#### Ordering Codes

#### \*FI-GE\*-10\*S\*3/4\*U\*-B\*-W3\*-MS

- \* Straight Male Stud Fitting **FI-GE**
- \* Outside Tube Diameter D1 (in mm) **-10**
- \* Series Light Series (pages 70/71) **L**  
Heavy Series (page 71) **S**
- \* Thread Size acc. to dimension table **3/4**  
Please always indicate thread sizes, e.g. 3/4!
- \* Thread Type UN/UNF Thread with O-Ring **U**
- \* Seal Material NBR (Buna-N®) **-B**  
FKM (Viton®) **-V**  
EPDM **-E**
- \* Material Code Steel, zinc/nickel-plated **-W3**  
Please contact STAUFF for alternative materials and surface finishings.
- \* Assembling / Kitting Fitting body only **—**  
Fitting body supplied with cutting ring and union nut **-MS**  
Fitting body supplied with soft-sealing cutting ring and union nut **-MSV**

#### Connecting Parts

- Cutting Ring Type **FI-DS** Page 28
- Soft-Sealing Cutting Ring Type **FI-WDDS** Page 29
- Support Sleeve Type **FI-VH** Page 31
- STAUFF Form EVO Sealing Ring Type **FI-FD** Page 32
- Union Nut Type **FI-M** Page 33
- 37° Flared Tube Fitting Set Type **FI-AB** Page 37

#### Spare Parts / Accessories

- O-Ring Type **O-RING** Page 239

#### O-Ring

#### UN/UNF Thread

Series	Tube OD (mm/in)	PN (bar/psi)	Dimensions (mm/in)										Torque (N·m)/(ft·lb)	Weight (kg)/(lbs) ca. per 100	Ordering Codes <sup>3</sup>
			D1	Thread	T	D2	i	L	L1 <sup>1</sup>	L2	S1	S2			
S	6	630	7/16-20 UNF	4	9	26	36	10	17	17	20	2,16	FI-GE-06S7/16U-B-W3		
	.24	9135		.16	.35	1.02	1.42	.39	.67	.67	14.7	4.76			
	8	630	7/16-20 UNF	4,5	11	29	38	11	17	19	20	2,65	FI-GE-08S7/16U-B-W3		
	.31	9135		.18	.43	1.14	1.50	.43	.67	.75	14.7	5.83			
	8	630	9/16-18 UNF	5	12	32	39,5	12,5	19	19	35	3,91	FI-GE-08S9/16U-B-W3		
	.31	9135		.2	.47	1.26	1.56	.49	.75	.75	25.8	8.62			
	10	630	9/16-18 UNF	7	12	32	41	12,5	19	22	35	3,73	FI-GE-10S9/16U-B-W3		
	.39	9135		.28	.47	1.26	1.61	.49	.75	.87	25.8	8.20			
	10	630	3/4-16 UNF	7	11	33,5	42	15	24	22	70	6,53	FI-GE-10S3/4U-B-W3		
	.39	9135		.28	.43	1.32	1.65	.59	.94	.87	51.8	14.40			
	12	630	9/16-18 UNF	7,5	12	36	45	16,5	24	24	35	6,09	FI-GE-12S9/16U-B-W3		
	.47	9135		.30	.47	1.42	1.77	.65	.94	.94	25.8	13.40			
	12	630	3/4-16 UNF	8	14	36	45	14,5	24	24	70	6,89	FI-GE-12S3/4U-B-W3		
	.47	9135		.31	.55	1.42	1.77	.57	.94	.94	51.8	15.15			
	12	630	3/4-16 UNF	7	16	33,5	42	15	24	22	70	7,56	FI-GE-12S3/4U-B-W3		
	.47	9135		.28	.63	1.32	1.65	.59	.94	.87	51.8	16.67			
	16	630	3/4-16 UNF	10	14	36	45	13,5	24	30	70	6,68	FI-GE-16S3/4U-B-W3		
	.63	9135		.39	.55	1.42	1.77	.53	.94	1.18	51.8	14.70			
	16	630	7/8-14 UNF	12	16	39,7	49,7	15,2	27	30	100	9,47	FI-GE-16S7/8U-B-W3		
	.63	9135		.47	.63	1.56	1.96	.60	1.06	1.18	74.0	20.84			
	16	630	1 1/16-12 UNF	15	18,5	47,5	59	20,5	32	30	170	15,76	FI-GE-16S1-1/16U-B-W3		
	.63	9135		.59	.73	1.87	2.32	.81	1.26	1.18	125.8	34.74			
	20	420	3/4-16 UNF	10	14	42	53	17,5	32	36	70	11,83	FI-GE-20S3/4U-B-W3		
	.79	6091		.39	.55	1.65	2.09	.69	1.26	1.42	51.8	26.02			
	20	420	7/8-14 UNF	12,5	16	44	55	17,5	32	36	100	15,20	FI-GE-20S7/8U-B-W3		
	.79	6091		.49	.63	1.73	2.17	.69	1.26	1.42	74.0	33.44			
	20	420	1 1/16-12 UN	15	18,5	46	57	17	32	36	170	19,70	FI-GE-20S1-1/16U-B-W3		
	.79	6091		.59	.73	1.81	2.24	.67	1.26	1.42	125.8	43.34			
	20	420	1 5/16-12 UNF	21,5	18,5	48	58	19	41	36	270	22,65	FI-GE-20S1-5/16U-B-W3		
	.79	6091		.85	.73	1.89	2.28	.75	1.61	1.42	199.8	49.93			
	25	420	1 1/16-12 UN	15	18,5	50	62	19,5	36	46	170	24,20	FI-GE-25S1-1/16U-B-W3		
	.98	6091		.59	.73	1.97	2.44	.77	1.42	1.81	125.8	53.24			
	25	420	1 5/16-12 UN	20	18,5	50	62	19,5	41	46	270	28,90	FI-GE-25S1-5/16U-B-W3		
	.98	6091		.79	.73	1.97	2.44	.77	1.61	1.81	199.8	63.58			
	30	420	1 1/16-12 UN	15	18,5	52	66	20	50	50	170	30,45	FI-GE-30S1-1/16U-B-W3		
	1.18	6091		.59	.73	2.05	2.60	.79	1.97	1.97	125.8	67.13			
	30	420	1 5/16-12 UN	21,5	18,5	52	65	20	46	50	270	30,70	FI-GE-30S1-5/16U-B-W3		
	1.18	6091		.85	.73	2.05	2.56	.79	1.81	1.97	199.8	67.54			
	30	420	1 5/8-12 UN	25	18,5	52	65	20	50	50	285	38,10	FI-GE-30S1-5/8U-B-W3		
	1.18	6091		.98	.73	2.05	2.56	.79	1.97	1.97	210.9	83.82			
	38	315	1 5/8-12 UN	27,5	18,5	57	72	22,5	55	60	285	47,6	FI-GE-38S1-5/8U-B-W3		
	1.50	4568		1.08	.73	2.24	2.83	.89	2.17	2.36	210.9	104.72			
	38	315	1 7/8-12 UN	32	18,5	57	72	22,5	55	60	415	50,70	FI-GE-38S1-7/8U-B-W3		
	1.50	4568		1.26	.73	2.24	2.83	.89	2.17	2.36	306.1	111.54			

<sup>1</sup> Approximate dimension in assembled condition.

<sup>2</sup> Weight excluding cutting ring and union nut.

<sup>3</sup> Standard scope of delivery: Fitting body only.

Male stud acc. to ISO 11926-2/-3

Port acc. to ISO 11926-1

Torque recommendations for Steel mating material.

Standard seal material is NBR (Buna-N®).

Male threaded studs were designed for female threaded ports in components made of steel. For applications with components made of softer mating materials (e.g. Aluminium), the use of connectors with additionally rolled male threads is recommended.

Please contact STAUFF prior to the assembly for further information.





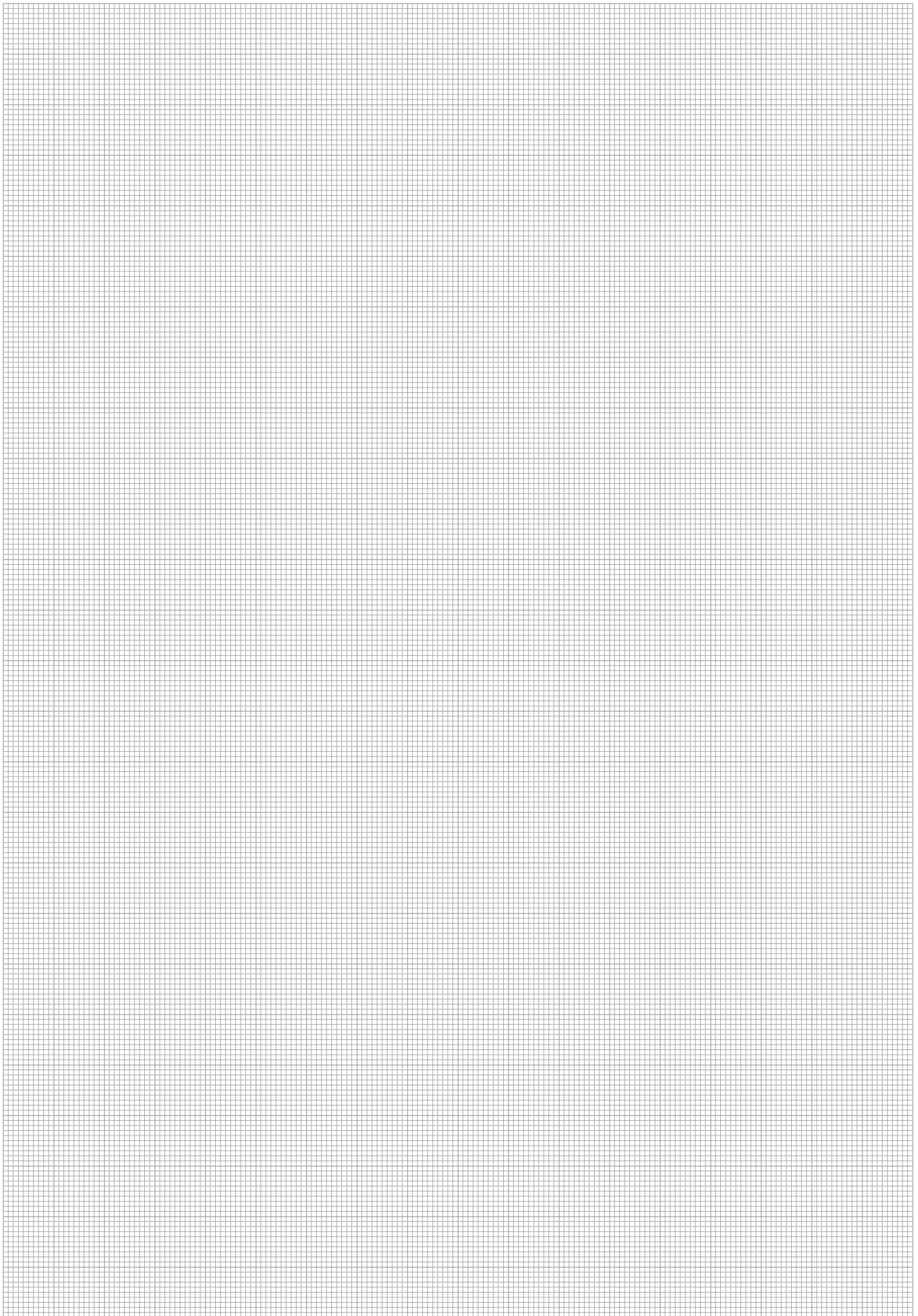

**Male Stud Elbow**  
Type FI-WE-...-R • Series L / S

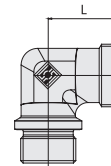
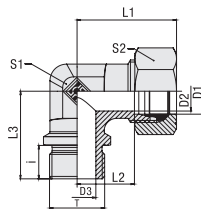

C

**Ordering Codes**

**\*FI-WE\*-25\*S\*R\*-W3\*-MS**

- \* Male Stud Elbow FI-WE
- \* Outside Tube Diameter D1 (in mm) -25
- \* Series L  
S
  - Light Series
  - Heavy Series
- \* Thread Type R
  - Whitworth Parallel Pipe Thread (BSPP)
- If required, please indicate special sizes, e.g. R3/4!
- \* Material Code -W3
  - Steel, zinc/nickel-plated
- Please contact STAUFF for alternative materials and surface finishings.
- \* Assembling / Kitting —
  - Fitting body only
  - Fitting body supplied with cutting ring and union nut -MS
  - Fitting body supplied with soft-sealing cutting ring and union nut -MSV

**Whitworth Parallel Pipe Thread (BSPP)**

**Metallic Sealing Edge**

Series	Tube OD (mm/in)	PN (°B/PS)	Dimensions (mm/in)											Torque (N·m/ft·lb)	Weight (kg/lbs) ca. per 100	Ordering Codes <sup>3</sup>
			Thread	T	D2	D3	i	L	L1 <sup>1</sup>	L2	L3	S1	S2			
L	22	160	G 3/4	19	18	16	35	44	27,5	42	27	36	180	1,78	FI-WE-22LR-W3	
	.87	2320		.75	.71	.63	1.38	1.73	1.08	1.65	1.06	1.42	133,2	3.92		
	28	160	G 1	24	23	18	38	47	30,5	48	36	41	330	3,12	FI-WE-28LR-W3	
	1.10	2320		.94	.91	.71	1.50	1.85	1.20	1.89	1.42	1.61	244,2	6.86		
	35	160	G 1 1/4	30	30	20	45	56	34,5	54	41	50	540	4,67	FI-WE-35LR-W3	
	1.38	2320		1.18	1.18	.79	1.77	2.20	1.36	2.13	1.61	1.97	399,6	10.27		
42	160	G 1 1/2	36	36	22	51	63	40	61	50	60	630	6,90	FI-WE-42LR-W3		
1.65	2320		1.42	1.42	.87	2.01	2.48	1.57	2.40	1.97	2.36	466,2	15.18			
S	20	420	G 3/4	16	16	16	37	48	26,5	42	27	36	270	2,15	FI-WE-20SR-W3	
	.79	6090		.63	.63	.63	1.46	1.89	1.04	1.65	1.06	1.42	199,8	4.73		
	25	420	G 3/4	20	18	16	42	54	30	48	36	46	270	3,77	FI-WE-25SR3/4-W3	
	.98	6090		.79	.71	.63	1.65	2.13	1.18	1.89	1.42	1.81	199,8	8.29		
	25	420	G 1	20	20	18	42	54	30	48	36	46	340	4,06	FI-WE-25SR-W3	
	.98	6090		.79	.79	.71	1.65	2.13	1.18	1.89	1.42	1.81	251,6	8.93		
	30	250	G 1 1/4	25	25	20	49	62	35,5	54	41	50	540	6,28	FI-WE-30SR-W3	
	1.18	3625		.98	.98	.79	1.93	2.44	1.40	2.13	1.61	1.97	399,6	13.82		
	38	250	G 1 1/2	32	32	22	57	72	41	61	50	60	700	9,15	FI-WE-38SR-W3	
	1.50	3625		1.26	1.26	.87	2.24	2.83	1.61	2.40	1.97	2.36	518,0	20.13		

<sup>1</sup> Approximate dimension in assembled condition.

<sup>2</sup> Weight excluding cutting ring and union nut.

<sup>3</sup> Standard scope of delivery: Fitting body only.

Male stud acc. to DIN 3852-2 (Form B) / ISO 1179-4 (Type B)  
Port acc. to DIN 3852-2 (Form X) / ISO 1179-1

Torque recommendations for Steel mating material.

**Connecting Parts**

- Cutting Ring  
Type **FI-DS** Page 28
- Soft-Sealing Cutting Ring  
Type **FI-WDDS** Page 29
- Support Sleeve  
Type **FI-VH** Page 31
- STAUFF Form EVO Sealing Ring  
Type **FI-FD** Page 32
- Union Nut  
Type **FI-M** Page 33
- 37° Flared Tube Fitting Set  
Type **FI-AB** Page 37

Male threaded studs were designed for female threaded ports in components made of steel. For applications with components made of softer mating materials (e.g. Aluminium), the use of connectors with additionally rolled male threads is recommended.

Please contact STAUFF prior to the assembly for further information.



Male Stud Elbow  
Type FI-WE...-M • Series L / S

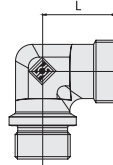
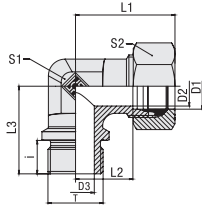

C

Metallic Sealing Edge

Metric Parallel Thread

Series	Tube OD PN		Dimensions											Torque (N·m/ft·lb)	Weight (kg/lbs) ca.	Ordering Codes <sup>3</sup>
	(mm/in)	(bar/psi)	(mm/in)													
L	22	250	M 26 x	19	18	16	35	44	27,5	42	27	36	190	1,73	FI-WE-22LM-W3	
	.87	3625	1,5	.75	.71	.63	1.38	1.73	1.08	1.65	1.06	1.42	140,6	3,81		
	28	250	M 33 x 2	24	23	18	38	47	30,5	48	36	41	340	3,04	FI-WE-28LM-W3	
	1.10	3625		.94	.91	.71	1.50	1.85	1.20	1.89	1.42	1.61	251,6	6,69		
	35	250	M 42 x 2	30	30	20	45	56	34,5	54	41	50	500	4,70	FI-WE-35LM-W3	
	1.38	3625		1.18	1.18	.79	1.77	2.20	1.36	2.13	1.61	1.97	370,0	10,35		
42	250	M 48 x 2	36	36	22	51	63	40	61	50	60	630	6,96	FI-WE-42LM-W3		
1.65	3625		1.42	1.42	.87	2.01	2.48	1.57	2.40	1.97	2.36	466,2	15,31			
S	20	420	M 27 x 2	16	16	16	37	48	26,5	42	27	36	270	2,14	FI-WE-20SM-W3	
	.79	6090		.63	.63	.63	1.46	1.89	1.04	1.65	1.06	1.42	199,8	4,71		
	25	250	M 33 x 2	20	20	18	42	54	30	48	36	46	410	4,46	FI-WE-25SM-W3	
	.98	3625		.79	.79	.71	1.65	2.13	1.18	1.89	1.42	1.81	303,4	9,81		
	30	250	M 42 x 2	25	25	20	49	62	35,5	54	41	50	540	6,33	FI-WE-30SM-W3	
	1.18	3625		.98	.98	.79	1.93	2.44	1.40	2.13	1.61	1.97	399,6	13,93		
	38	250	M 48 x 2	32	32	22	57	72	41	61	50	60	700	9,24	FI-WE-38SM-W3	
	1.50	3625		1.26	1.26	.87	2.24	2.83	1.61	2.40	1.97	2.36	518,0	20,33		

<sup>1</sup> Approximate dimension in assembled condition.

<sup>2</sup> Weight excluding cutting ring and union nut.

<sup>3</sup> Standard scope of delivery: Fitting body only.

Male stud acc. to DIN 3852-1 (Form B) / ISO 9974-3 (Type B)  
Port acc. to DIN 3852-1 (Form X) / ISO 9974-1

Torque recommendations for Steel mating material.

Male threaded studs were designed for female threaded ports in components made of steel. For applications with components made of softer mating materials (e.g. Aluminium), the use of connectors with additionally rolled male threads is recommended.

Please contact STAUFF prior to the assembly for further information.

### Ordering Codes

**\*FI-WE\*-25\*S\*M\*-W3\*-MS**

- \* Male Stud Elbow **FI-WE**
- \* Outside Tube Diameter D1 (in mm) **-25**
- \* Series Light Series **L**  
Heavy Series **S**
- \* Thread Type Metric Parallel Thread **M**

If required, please indicate special sizes, e.g. M27x2!

- \* Material Code Steel, zinc/nickel-plated **-W3**

Please contact STAUFF for alternative materials and surface finishings.

- \* Assembling / Kitting Fitting body only **—**  
Fitting body supplied with cutting ring and union nut **-MS**  
Fitting body supplied with soft-sealing cutting ring and union nut **-MSV**

### Connecting Parts

- Cutting Ring Type **FI-DS** Page 28
- Soft-Sealing Cutting Ring Type **FI-WDDS** Page 29
- Support Sleeve Type **FI-VH** Page 31
- STAUFF Form EVO Sealing Ring Type **FI-FD** Page 32
- Union Nut Type **FI-M** Page 33
- 37° Flared Tube Fitting Set Type **FI-AB** Page 37



**Male Stud Elbow**  
Type FI-WE-...-Rk ■ Series LL / L

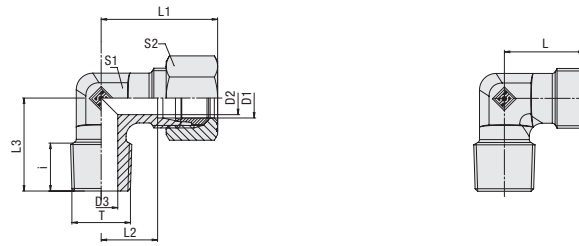

...-PR

**Ordering Codes**

**\*FI-WE\*-10\*L\*Rk\*-W3\*-MS**

* Male Stud Elbow	<b>FI-WE</b>
* Outside Tube Diameter D1 (in mm)	<b>-10</b>
* Series	Extra-Light Series (page 76) <b>LL</b> Light Series (page 76) <b>L</b> Heavy Series (page 77) <b>S</b>
* Thread Type	Whitworth Taper Pipe Thread (BSPT) <b>Rk</b>
If required, please indicate special sizes, e.g. R3/8k!	
* Material Code	Steel, zinc/nickel-plated <b>-W3</b>
Please contact STAUFF for alternative materials and surface finishings.	
* Design	Made from forging blanks <b>—</b> Made from profile material <b>PR</b>
* Assembling / Kitting	Fitting body only <b>—</b> Fitting body supplied with cutting ring and union nut <b>-MS</b> Fitting body supplied with soft-sealing cutting ring and union nut <b>-MSV</b>

**Connecting Parts**

	Cutting Ring Type <b>FI-DS</b>	Page 28
	Soft-Sealing Cutting Ring Type <b>FI-WDDS</b>	Page 29
	Support Sleeve Type <b>FI-VH</b>	Page 31
	STAUFF Form EVO Sealing Ring Type <b>FI-FD</b>	Page 32
	Union Nut Type <b>FI-M</b>	Page 33
	37° Flared Tube Fitting Set Type <b>FI-AB</b>	Page 37

Male threaded studs were designed for female threaded ports in components made of steel. For applications with components made of softer mating materials (e.g. Aluminium), the use of connectors with additionally rolled male threads is recommended.  
Please contact STAUFF prior to the assembly for further information.

**Whitworth Taper Pipe Thread (BSPT)**

Series	Tube OD (mm/in)	PN (bar/psi)	Dimensions (mm/in)										Weight (kg/lbs) ca. per 100	Ordering Codes <sup>3</sup>
			Thread	T	D2	D3	i	L	L1 <sup>1</sup>	L2	L3	S1		
LL	4	100	R 1/8 keg.	3	3	8	15	21	11	17	11	10	1.46	FI-WE-04LLRk-W3-PR
	.16	1450		.12	.12	.31	.59	.83	.43	.67	.43	.39	3.12	
	6	100	R 1/8 keg.	4,5	4,5	8	15	21	9,5	17	11	12	1,73	FI-WE-06LLRk-W3-PR
	.24	1450		.18	.18	.31	.59	.83	.37	.67	.43	.47	3.81	
	8	100	R 1/8 keg.	6	6	8	17	23	11,5	20	12	14	2,63	FI-WE-08LLRk-W3-PR
	.31	1450		.24	.24	.31	.67	.91	.45	.79	.47	.55	5.79	
	10	100	R 1/4 keg.	8	7	12	21,5	27,5	16	26	14	14	9,10	FI-WE-10LLRk-W3
	.39	1450		.31	.28	.47	.85	1.08	.63	1.02	.55	.55	20.02	
	12	100	R 1/4 keg.	10	7	9,9	22	28	16	23	14	17	11,40	FI-WE-12LLRk-W3
	.47	1450		.39	.28	.39	.87	1.10	.63	.91	.55	.67	25.08	
L	6	315	R 1/8 keg.	4	4	8	19	27	12	20	12	14	1,96	FI-WE-06LRk-W3
	.24	4568		.16	.16	.31	.75	1.06	.47	.79	.47	.55	4.32	
	6	315	R 1/4 keg.	4	6	12	21	29	14	25,5	12	14	2,93	FI-WE-06LR1/4k-W3
	.24	4568		.16	.24	.47	.83	1.14	.55	1.00	.47	.55	6.44	
	6	315	R 3/8 keg.	4	9	12	24	31	17	28	14	14	4,42	FI-WE-06LR3/8k-W3
	.24	4568		.16	.35	.47	.94	1.22	.67	1.1	.55	.55	9.74	
	8	315	R 1/8 keg.	6	4	8	21	29	14	26	12	17	2,64	FI-WE-08LR1/8k-W3
	.31	4568		.24	.16	.31	.83	1.14	.55	1.02	.47	.67	5.80	
	8	315	R 1/4 keg.	6	6	12	21	29	14	26	12	17	2,93	FI-WE-08LRk-W3
	.31	4568		.24	.24	.47	.83	1.14	.55	1.02	.47	.67	6.45	
	8	315	R 3/8 keg.	6	9	14	24	32	17	28	14	17	4,34	FI-WE-08LR3/8k-W3
	.31	4568		.24	.35	.55	.94	1.26	.67	1.10	.55	.67	9.54	
	10	315	R 1/8 keg.	8	6	7,3	22,5	29	15,5	20	14	19	2,96	FI-WE-10LR1/8k-W3
	.39	4568		.31	.24	.29	.89	1.14	.61	.79	.55	.75	6.53	
	10	315	R 1/4 keg.	8	7	13	22	30	15	27	14	19	3,53	FI-WE-10LRk-W3
	.39	4568		.31	.28	.51	.87	1.18	.59	1.06	.55	.75	7.76	
	10	315	R 3/8 keg.	8	8	12,5	22	30	15	28	14	19	4,29	FI-WE-10LR3/8k-W3
	.39	4568		.31	.31	.49	.87	1.18	.59	1.10	.55	.75	9.43	
	10	315	R 1/2 keg.	8	11	14	28	35	21	34	19	19	9,56	FI-WE-10LR1/2k-W3
	.39	4568		.31	.43	.55	1.1	1.38	.83	1.34	.75	.75	21.08	
	12	315	R 1/4 keg.	10	7	14,3	24	32	17	27	17	22	4,57	FI-WE-12LR1/4k-W3
	.47	4568		.39	.28	.56	.94	1.26	.67	1.06	.67	.87	10.06	
	12	315	R 3/8 keg.	10	9	13	24	32	17	28,5	17	22	5,33	FI-WE-12LRk-W3
	.47	4568		.39	.35	.51	.94	1.26	.67	1.12	.67	.87	11.72	
	12	315	R 1/2 keg.	10	10	14	28	36	21	34	19	22	9,94	FI-WE-12LR1/2k-W3
	.47	4568		.39	.39	.55	1.10	1.42	.83	1.34	.75	.87	21.87	
	15	315	R 3/8 keg.	12	9	14	28	36	21	34	19	27	8,79	FI-WE-15LR3/8k-W3
	.59	4568		.47	.35	.55	1.10	1.42	.83	1.34	.75	1.06	19.33	
15	315	R 1/2 keg.	12	12	16	28	36	21	34	19	27	9,12	FI-WE-15LRk-W3	
.59	4568		.47	.47	.63	1.10	1.42	.83	1.34	.75	1.06	20.06		
15	315	R 3/4 keg.	12	12	17	33	40	26	36	24	27	4,05	FI-WE-15LR3/4k-W3	
.59	4568		.47	.47	.67	1.3	1.57	1.02	1.42	.94	1.06	8.93		
18	315	R 1/2 keg.	15	14	17,5	31	40	23,5	36	24	32	11,63	FI-WE-18LRk-W3	
.71	4568		.59	.55	.69	1.22	1.57	.93	1.42	.94	1.26	25.58		
18	315	R 3/4 keg.	15	16	16	31	41,5	23,5	36	27	32	13,2	FI-WE-18LR3/4k-W3	
.71	4568		.59	.63	.63	1.22	1.63	.93	1.42	1.06	1.26	29.10		
22	160	R 3/4 keg.	19	18	17	35	44	28,5	42,5	27	36	16,80	FI-WE-22LRk-W3	
.87	2320		.75	.71	.67	1.38	1.73	1.12	1.67	1.06	1.42	36.96		
28	160	R 1 keg.	24	23	20	38	47	30,5	48	36	41	30,7	FI-WE-28LRk-W3	
1.1	2320		.94	.91	.79	1.5	1.85	1.20	1.89	1.42	1.61	67.68		
35	160	R 1 1/4 keg.	30	30	20	48	59	37,5	51	41	50	46,7	FI-WE-35LRk-W3	
1.38	2320		1.18	1.18	.79	1.89	2.32	1.48	2.01	1.61	1.97	102.96		
42	160	R 1 1/2 keg.	36	36	20	54	59	43	61	50	60	72,3	FI-WE-42LRk-W3	
1.65	2320		1.42	1.42	.79	2.13	2.32	1.69	2.4	1.97	2.36	159.39		

<sup>1</sup> Approximate dimension in assembled condition.

<sup>2</sup> Weight excluding cutting ring and union nut.

<sup>3</sup> Standard scope of delivery: Fitting body only.

Male stud acc. to DIN 3852-2 (Form C)

Port acc. to DIN 3852-2 (Form Z)

Suitable liquid / plastic sealant required.



Male Stud Elbow  
Type FI-WE-...-Rk ▪ Series S

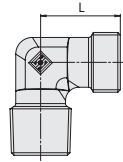
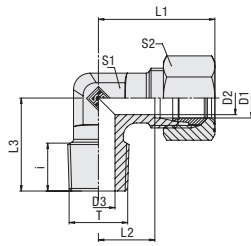

C

Whitworth Taper Pipe Thread (BSPT)

Series	Tube OD PN		Dimensions											Weight (kg/lbs) ca. per 100	Ordering Codes <sup>3</sup>
	(mm/in)	(bar/psi)	Thread	T	D2	D3	i	L	L1 <sup>1</sup>	L2	L3	S1	S2		
S	6	400	R 1/4 keg.	4	4	12	23	31	16	26	12	17	5,73	FI-WE-06SRk-W3	
	.24	5800		.16	.16	.47	.91	1.22	.63	1.02	.47	.67	12.60		
	8	400	R 1/4 keg.	5	5	13	24	32	17	27	14	19	4,70	FI-WE-08SRk-W3	
	.31	5800		.20	.20	.51	.94	1.26	.67	1.06	.55	.75	10.34		
	10	400	R 1/4 keg.	7	5	13	25	34	17,5	28	17	22	5,94	FI-WE-10SR1/4k-W3	
	.39	5800		.28	.20	.51	.98	1.34	.69	1.10	.67	.87	13.06		
	10	400	R 3/8 keg.	7	7	13	25	34	17,5	28	17	22	6,71	FI-WE-10SRk-W3	
	.39	5800		.28	.28	.51	.98	1.34	.69	1.10	.67	.87	14.77		
	10	400	R 1/2 keg.	7	7	13	30	38	22,5	32	19	22	11,67	FI-WE-10SR1/2k-W3	
	.39	5800		.28	.28	.51	1.18	1.50	.89	1.26	.75	.87	25.73		
	12	400	R 3/8 keg.	8	7	12	29	38	21,5	28	17	24	7,78	FI-WE-12SRk-W3	
	.47	5800		.31	.28	.47	1.14	1.50	.85	1.10	.67	.94	17.12		
	12	400	R 1/2 keg.	8	10	14	30	39	22,5	32	19	24	4,67	FI-WE-12SR1/2k-W3	
	.47	5800		.31	.39	.55	1.18	1.54	.89	1.26	.75	.94	10.27		
	14	400	R 3/8 keg.	10	8	14	30	40	22	32	19	27	9,62	FI-WE-14SR3/8k-W3	
	.55	5800		.39	.31	.55	1.18	1.57	.87	1.26	.75	1.06	14.59		
	14	400	R 1/2 keg.	10	10	14	30	40	22	32	19	27	10,53	FI-WE-14SRk-W3	
	.55	5800		.39	.39	.55	1.18	1.57	.87	1.26	.75	1.06	23.17		
	16	400	R 1/2 keg.	12	12	14	34	44	25,5	32	24	30	13,60	FI-WE-16SRk-W3	
	.63	5800		.47	.47	.55	1.34	1.73	1.00	1.26	1.78	66.0	29.92		
	16	400	R 3/4 keg.	12	12	14	34	44	25,5	32	24	30	22,00	FI-WE-16SR3/4k-W3	
	.63	5800		.47	.47	.55	1.34	1.73	1.00	1.26	.94	1.18	48.40		
	20	400	R 1/2 keg.	16	10	14	37	48	26,5	42	27	36	21,00	FI-WE-20SR1/2k-W3	
	.79	5800		.63	.39	.55	1.46	1.89	1.04	1.65	1.06	1.42	46.20		
	20	250	R 3/4 keg.	16	16	17	39	48	26,5	42	27	36	21,19	FI-WE-20SRk-W3	
	.79	3625		.63	.63	.67	1.54	1.89	1.04	1.65	1.06	1.42	46.72		
	25	250	R 3/4 keg.	20	16	17	42	53	30	48	36	46	37,27	FI-WE-25SR3/4k-W3	
	.98	3625		.79	.63	.67	1.65	2.09	1.18	1.89	1.42	1.81	82.17		
	25	250	R 1 keg.	20	20	20	42	53	30	48	36	46	39,3	FI-WE-25SRk-W3	
	.98	3625		.79	.79	.79	1.65	2.09	1.18	1.89	1.42	1.81	86.64		
	30	250	R 1 1/4 keg.	25	25	20	52	62	35,5	54	41	50	62,61	FI-WE-30SRk-W3	
	1.18	3625		.98	.98	.79	2.05	2.44	1.4	2.13	1.61	1.97	138.03		
	38	250	R 1 1/2 keg.	32	32	20	52	71	41	61	50	60	93,8	FI-WE-38SRk-W3	
	1.50	3625		1.26	1.26	.79	2.05	2.80	1.61	2.40	1.97	2.36	206.80		

<sup>1</sup> Approximate dimension in assembled condition.  
<sup>2</sup> Weight excluding cutting ring and union nut.  
<sup>3</sup> Standard scope of delivery: Fitting body only.

Male stud acc. to DIN 3852-2 (Form C)  
 Port acc. to DIN 3852-2 (Form Z)

Suitable liquid / plastic sealant required.

Ordering Codes

\*FI-WE\*-10\*S\*Rk\*-W3\*-MS

* Male Stud Elbow	FI-WE
* Outside Tube Diameter D1 (in mm)	-10
* Series	Extra-Light Series (page 76) LL Light Series (page 76) L Heavy Series (page 77) S
* Thread Type	Whitworth Taper Pipe Thread (BSPT) Rk
If required, please indicate special sizes, e.g. R3/8k!	
* Material Code	Steel, zinc/nickel-plated -W3
Please contact STAUFF for alternative materials and surface finishings.	
* Assembling / Kitting	Fitting body only —
	Fitting body supplied with cutting ring and union nut -MS
	Fitting body supplied with soft-sealing cutting ring and union nut -MSV

Connecting Parts

	Cutting Ring Type FI-DS	Page 28
	Soft-Sealing Cutting Ring Type FI-WDDS	Page 29
	Support Sleeve Type FI-VH	Page 31
	STAUFF Form EVO Sealing Ring Type FI-FD	Page 32
	Union Nut Type FI-M	Page 33
	37° Flared Tube Fitting Set Type FI-AB	Page 37

Male threaded studs were designed for female threaded ports in components made of steel. For applications with components made of softer mating materials (e.g. Aluminium), the use of connectors with additionally rolled male threads is recommended.  
 Please contact STAUFF prior to the assembly for further information.



**Male Stud Elbow**  
Type FI-WE-...-Mk ▪ Series LL / L / S

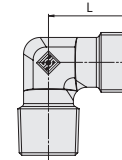
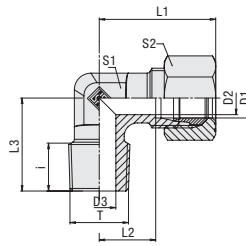

Metric Taper Thread

**Ordering Codes**

**\*FI-WE\*-10\*L\*Mk\*-W3\*-MS**

- \* Male Stud Elbow **FI-WE**
- \* Outside Tube Diameter D1 (in mm) **-10**
- \* Series **LL**  
 Extra-Light Series **L**  
 Light Series **S**  
 Heavy Series
- \* Thread Type **Mk**  
 Metric Taper Thread
- If required, please indicate special sizes, e.g. M12x1.5k!
- \* Material Code **-W3**  
 Steel, zinc/nickel-plated
- Please contact STAUFF for alternative materials and surface finishings.
- \* Design **—**  
 Made from forging blanks **PR**  
 Made from profile material
- \* Assembling / Kitting **—**  
 Fitting body only **-MS**  
 Fitting body supplied with cutting ring and union nut **-MSV**  
 Fitting body supplied with soft-sealing cutting ring and union nut

**Connecting Parts**

-  Cutting Ring  
Type **FI-DS** Page 28
-  Soft-Sealing Cutting Ring  
Type **FI-WDDS** Page 29
-  Support Sleeve  
Type **FI-VH** Page 31
-  STAUFF Form EVO Sealing Ring  
Type **FI-FD** Page 32
-  Union Nut  
Type **FI-M** Page 33
-  37° Flared Tube Fitting Set  
Type **FI-AB** Page 37

Series	Tube OD		PN	Dimensions											Weight ( <sup>kg</sup> / <sub>lbs</sub> ) ca. per 100	Ordering Codes <sup>3</sup>	
	(mm/in)	(mm/in)		(mm/in)	Thread	T	D2	D3	i	L	L1 <sup>1</sup>	L2	L3	S1			S2
LL	4	100	100	M 6 x 1 keg.	3	2	8,5	15	20	11	17	9	10	1,34	FI-WE-04LLM6x1k-W3-PR		
	.16	1450				.12	.08	.33	.59	.79	.43	.67	.35	.39		2,95	
	4	100		M 8 x 1 keg.	3	3,5	8	15	21	11	17	9	10	1,46		FI-WE-04LLMk-W3-PR	
	.16	1450			.12	.14	.31	.59	.83	.43	.67	.35	.39	3,12			
	6	100	M 6 x 1 keg.	4,5	2	8	15	21	9,5	15	11	12	1,44	FI-WE-06LLM6x1k-W3-PR			
	.24	1450			.18	.08	.31	.59	.83	.37	.59	.43	.47		3,17		
	6	100	M 8 x 1 keg.	4,5	3,5	8,5	15	21	9,5	17	11	12	1,64		FI-WE-06LLM8x1k-W3-PR		
	.24	1450			.18	.14	.33	.59	.83	.37	.67	.43	.47	3,62			
	6	100	M 10 x 1 keg.	4,5	4,5	8	15	21	9,5	17	11	12	1,74	FI-WE-06LLMk-W3-PR			
	.24	1450			.18	.18	.31	.59	.83	.37	.67	.43	.47		3,83		
	8	100	M 10 x 1 keg.	6	6	8	17	23	11,5	20	12	14	2,82		FI-WE-08LLMk-W3-PR		
	.31	1450			.24	.24	.31	.67	.91	.45	.79	.47	.55	6,20			
L	6	315	315	M 10 x 1 keg.	4	4	8	19	27	12	20	12	14	2,16		FI-WE-06LMk-W3	
	.24	4568				.16	.16	.31	.75	1,06	.47	.79	.47	.55	4,75		
	8	315		M 12 x 1,5 keg.	6	6	12	21	29	14	26	12	17	2,67	FI-WE-08LMk-W3		
	.31	4568			.24	.24	.47	.83	1,14	.55	1,02	.47	.67	5,88			
	10	315	M 14 x 1,5 keg.	8	7	11,5	22	30	15	27	14	19	4,19	FI-WE-10LMk-W3			
	.39	4568			.31	.28	.45	.87	1,18	.59	1,06	.55	.75		9,23		
	12	315	M 16 x 1,5 keg.	10	9	11,5	24	32	17	28	17	22	5,05		FI-WE-12LMk-W3		
	.47	4568			.39	.35	.45	.94	1,26	.67	1,10	.67	.87	11,10			
	12	315	M 18 x 1,5 keg.	10	10	11,5	29	36	22	28	17	22	5,79	FI-WE-12LM18x1.5k-W3			
	.47	4568			.39	.39	.45	1,14	1,42	.87	1,10	.67	.87		12,76		
	15	315	M 18 x 1,5 keg.	12	11	12	28	36	21	32	19	27	8,82		FI-WE-15LMk-W3		
	.59	4568			.47	.43	.47	1,10	1,42	.83	1,26	.75	1,06	19,41			
	18	315	M 22 x 1,5 keg.	15	14	14	31	40	23,5	36	24	32	12,56	FI-WE-18LMk-W3			
	.71	4568			.59	.55	.55	1,22	1,57	.93	1,42	.94	1,26		27,64		
	S	6	400	400	M 12 x 1,5 keg.	4	4	12	23	31	16	26	12		17	3,44	FI-WE-06SMk-W3
		.24	5800				.16	.16	.47	.91	1,22	.63	1,02	.47	.67	7,56	
		8	400		M 14 x 1,5 keg.	5	5	11,5	24	32	17	27	14	19	5,33	FI-WE-08SMk-W3	
		.31	5800			.20	.20	.45	.94	1,26	.67	1,06	.55	.75	11,73		
10		400	M 16 x 1,5 keg.	7	7	11,5	25	34	17,5	28	17	22	6,35	FI-WE-10SMk-W3			
.39		5800			.28	.28	.45	.98	1,34	.69	1,10	.67	.87		13,97		
12		400	M 18 x 1,5 keg.	8	8	12	29	38	21,5	28	17	24	8,19		FI-WE-12SMk-W3		
.47		5800			.31	.31	.47	1,14	1,50	.85	1,10	.67	.94	18,02			
14		400	M 20 x 1,5 keg.	10	10	14	30	40	22	32	19	27	11,45	FI-WE-14SMk-W3			
.55		5800			.39	.39	.55	1,18	1,57	.87	1,26	.75	1,06		25,19		
16		400	M 22 x 1,5 keg.	12	12	14	33	43	24,5	32	24	30	9,62		FI-WE-16SMk-W3		
.63		5800			.47	.47	.55	1,30	1,69	.96	1,26	.94	1,18	21,17			

<sup>1</sup> Approximate dimension in assembled condition.  
<sup>2</sup> Weight excluding cutting ring and union nut.  
<sup>3</sup> Standard scope of delivery: Fitting body only.

Male stud acc. to DIN 3852-1 (Form C)  
 Port acc. to DIN 3852-1 (Form Z)

Suitable liquid / plastic sealant required.

Male threaded studs were designed for female threaded ports in components made of steel. For applications with components made of softer mating materials (e.g. Aluminium), the use of connectors with additionally rolled male threads is recommended.  
 Please contact STAUFF prior to the assembly for further information.



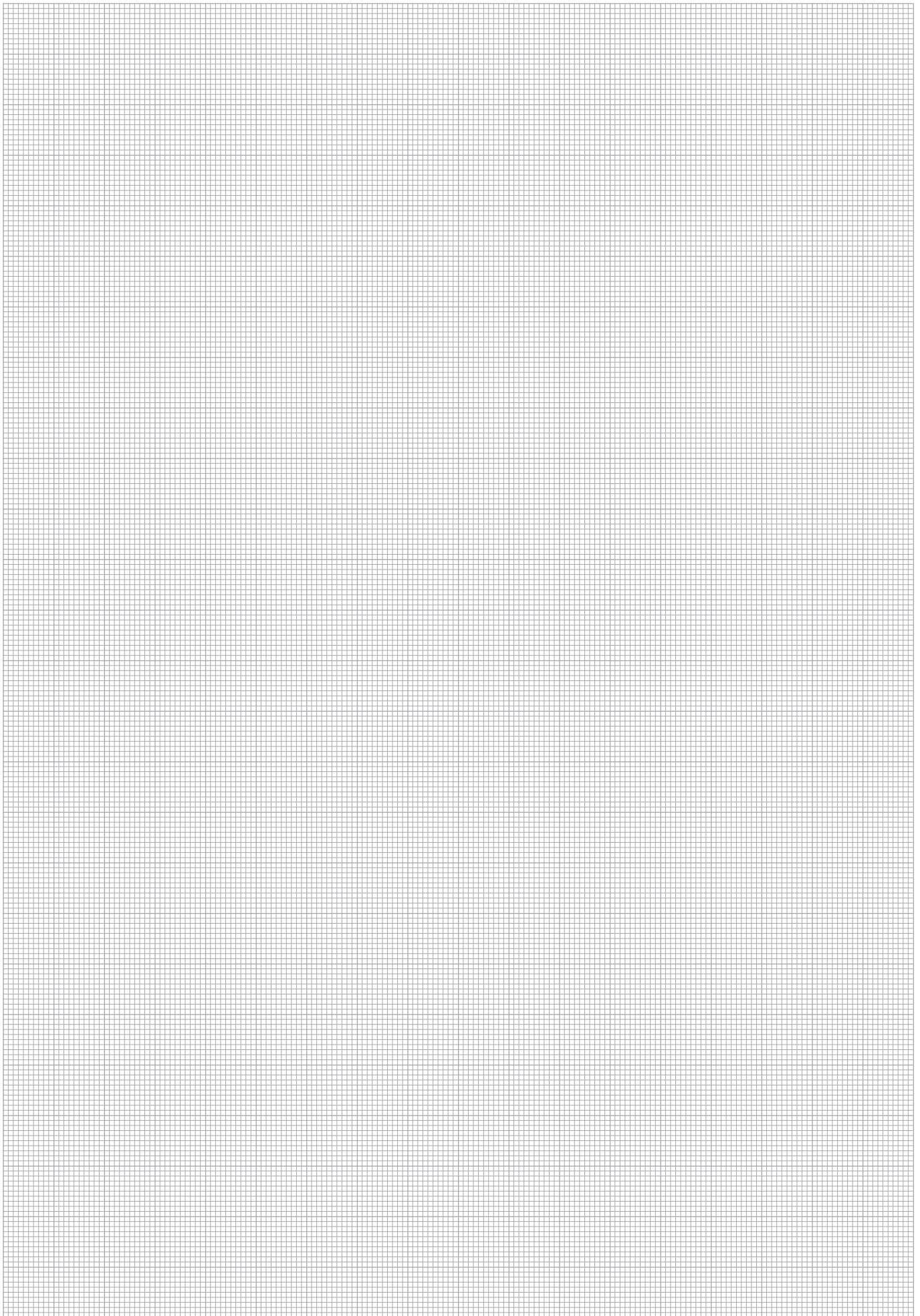

**Male Stud Elbow**  
Type FI-WE-...-N • Series LL / L

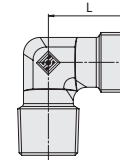
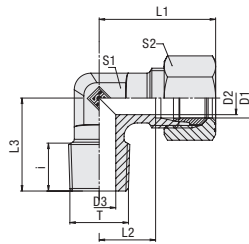

C



**Ordering Codes**

**\*FI-WE\*-10\*L\*1/4\*N\*-W3\*-MS**

- \* Male Stud Elbow **FI-WE**
- \* Outside Tube Diameter D1 (in mm) **-10**
- \* Series **LL** Extra-Light Series (page 80)  
**L** Light Series (page 80)  
**S** Heavy Series (page 81)
- \* Thread Size **1/4** acc. to dimension table  
Please always indicate thread sizes, e.g. 1/4!
- \* Thread Type **N** NPT Thread
- \* Material Code **-W3** Steel, zinc/nickel-plated  
Please contact STAUFF for alternative materials and surface finishings.
- \* Design **—** Made from forging blanks  
**PR** Made from profile material
- \* Assembling / Kitting **—** Fitting body only  
**-MS** Fitting body supplied with cutting ring and union nut  
**-MSV** Fitting body supplied with soft-sealing cutting ring and union nut

**Connecting Parts**

- Cutting Ring  
Type **FI-DS** Page 28
- Soft-Sealing Cutting Ring  
Type **FI-WDDS** Page 29
- Support Sleeve  
Type **FI-VH** Page 31
- STAUFF Form EVO Sealing Ring  
Type **FI-FD** Page 32
- Union Nut  
Type **FI-M** Page 33
- 37° Flared Tube Fitting Set  
Type **FI-AB** Page 37

**NPT Thread**

Series	Tube OD (mm/in)	PN (bar/psi)	Dimensions (mm/in)											Weight (kg/lbs) ca. per 100	Ordering Codes <sup>3</sup>
			Thread	T	D2	D3	i	L	L1 <sup>1</sup>	L2	L3	S1	S2		
LL	4	100	1/8 NPT	3	4	8	15	21	11	15,6	11	10	1,81	FI-WE-04LL1/8N-W3-PR	
	.16	1450		.12	.16	.31	.59	.83	.43	.61	.43	.39	3,98		
	6	100	1/8 NPT	4,5	4,5	8	15	21	9,5	17	11	12	1,57	FI-WE-06LL1/8N-W3-PR	
	.24	1450		.18	.18	.31	.59	.83	.37	.67	.43	.47	3,45		
L	8	100	1/8 NPT	6	6	10	17	23	11,5	20	12	14	2,64	FI-WE-08LL1/8N-W3-PR	
	.31	1450		.24	.24	.39	.67	.91	.45	.79	.47	.55	5,80		
	6	315	1/8 NPT	4	5	8	19	27	11,5	20	12	14	1,91	FI-WE-06L1/8N-W3	
	.24	4568		.16	.20	.31	.75	1,06	.45	.79	.47	.55	4,20		
L	6	315	1/4 NPT	4	7	10	21	29	14	26	14	14	2,80	FI-WE-06L1/4N-W3	
	.24	4568		.16	.28	.39	.83	1,14	.55	1,02	.55	.55	6,15		
	6	315	3/8 NPT	4	8	10,5	25	33	18	28	17	14	5,63	FI-WE-06L3/8N-W3	
	.24	4568		.16	.31	.41	.98	1,30	.71	1,10	.67	.55	12,38		
L	8	315	1/8 NPT	6	4	7	21	29	14	26	12	17	2,36	FI-WE-08L1/8N-W3	
	.31	4568		.24	.16	.28	.83	1,14	.55	1,02	.47	.67	5,20		
	8	315	1/4 NPT	6	6	11,4	21	29	14	26	12	17	2,92	FI-WE-08L1/4N-W3	
	.31	4568		.24	.24	.45	.83	1,14	.55	1,02	.47	.67	6,42		
L	10	315	1/4 NPT	8	7	11,4	22	30	15	27	14	19	3,56	FI-WE-10L1/4N-W3	
	.39	4568		.31	.28	.45	.87	1,18	.59	1,06	.55	.75	7,82		
	10	315	3/8 NPT	8	8	10,5	24	32	17	28	17	19	5,67	FI-WE-10L3/8N-W3	
	.39	4568		.31	.31	.41	.94	1,26	.67	1,10	.67	.75	12,47		
L	12	315	1/4 NPT	10	7	11,4	24	32	17	28	17	22	4,81	FI-WE-12L1/4N-W3	
	.47	4568		.39	.28	.45	.94	1,26	.67	1,10	.67	.87	10,58		
	12	315	3/8 NPT	10	8	10,5	24	32	17	28	17	22	4,87	FI-WE-12L3/8N-W3	
	.47	4568		.39	.31	.41	.94	1,26	.67	1,10	.67	.87	10,71		
L	12	315	1/2 NPT	10	11	14	28	36	21	34	19	22	7,99	FI-WE-12L1/2N-W3	
	.47	4568		.39	.43	.55	1,10	1,42	.83	1,34	.75	.87	17,57		
	15	315	1/2 NPT	12	14	14	28	39	21	34	19	27	8,05	FI-WE-15L1/2N-W3	
	.59	4568		.47	.55	.55	1,10	1,54	.83	1,34	.75	1,06	17,70		
L	18	315	1/2 NPT	15	12	14	31	40	23,5	36	24	32	12,79	FI-WE-18L1/2N-W3	
	.71	4568		.59	.47	.55	1,22	1,57	.93	1,42	.94	1,26	28,14		
	22	160	3/4 NPT	19	16	14	35	44	27,5	42	27	36	17,07	FI-WE-22L3/4N-W3	
	.87	2320		.75	.63	.55	1,38	1,73	1,08	1,65	1,06	1,42	37,56		
L	28	160	1 NPT	24	21	17,5	38	47	30,5	48	36	41	32,40	FI-WE-28L1N-W3	
	1.10	2320		.94	.83	.69	1,50	1,85	1,20	1,89	1,42	1,61	71,28		
	35	160	1 1/4 NPT	30	28	18	48	59	34,5	54	41	50	51,70	FI-WE-35L1-1/4N-W3	
	1.38	2320		1.18	1.10	.71	1.89	2.32	1.36	2.13	1.61	1.97	113,74		
L	42	160	1 1/2 NPT	36	34	18,5	54	66	43	61	50	60	74,60	FI-WE-42L1-1/2N-W3	
	1.65	2320		1.42	1.34	.73	2.13	2.60	1.69	2.40	1.97	2.36	164,12		

<sup>1</sup> Approximate dimension in assembled condition.

<sup>2</sup> Weight excluding cutting ring and union nut.

<sup>3</sup> Standard scope of delivery: Fitting body only.

Male stud acc. to ANSI/ASME B1.20.1-1983

Port acc. to ANSI/ASME B1.20.1-1983

Suitable liquid / plastic sealant required.

Male threaded studs were designed for female threaded ports in components made of steel. For applications with components made of softer mating materials (e.g. Aluminium), the use of connectors with additionally rolled male threads is recommended.

Please contact STAUFF prior to the assembly for further information.





Male Stud Elbow  
Type FI-WE-...-N • Series S

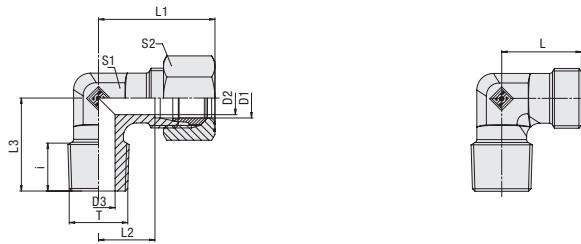

C

NPT Thread

Series	Tube OD PN		Dimensions											Weight (kg/lbs) ca. per 100	Ordering Codes <sup>3</sup>
	(mm/in)	(bar/psi)	(mm/in)	Thread	T	D2	D3	i	L	L1 <sup>1</sup>	L2	L3	S1		
S	6	630	1/4 NPT	4	4	10	23	31	16	26	12	17	3,19	FI-WE-06S1/4N-W3	
	.24	9135		.16	.16	.39	.91	1.22	.63	1.02	.47	.67	7.02		
8	630	9135	1/4 NPT	5	5	10	24	32	17	27	14	19	4,41	FI-WE-08S1/4N-W3	
	.31			.20	.20	.39	.94	1.26	.67	1.06	.55	.75	9.69		
8	630	9135	3/8 NPT	5	8	10,5	25	33	18	28	17	19	7,80	FI-WE-08S3/8N-W3	
	.31			.20	.31	.41	.98	1.30	.71	1.10	.67	.75	17.16		
8	630	9135	1/2 NPT	5	10	14	30	38	23	34	19	19	8,30	FI-WE-08S1/2N-W3	
	.31			.20	.39	.55	1.18	1.50	.91	1.34	.75	.75	18.26		
10	630	9135	1/4 NPT	7	5	10	25	34	17,5	28	17	22	6,17	FI-WE-10S1/4N-W3	
	.39			.28	.20	.39	.98	1.34	.69	1.10	.67	.87	13.57		
10	630	9135	3/8 NPT	7	7	10,5	25	34	17,5	28	17	22	6,64	FI-WE-10S3/8N-W3	
	.39			.28	.28	.41	.98	1.34	.69	1.10	.67	.87	14.62		
12	630	9135	1/4 NPT	8	5	11,4	29	38	21,5	29	17	24	7,87	FI-WE-12S1/4N-W3	
	.47			.31	.20	.45	1.14	1.50	.85	1.14	.67	.94	17.31		
12	630	9135	3/8 NPT	8	8	10,5	29	38	21,5	28	17	24	7,76	FI-WE-12S3/8N-W3	
	.47			.31	.31	.41	1.14	1.50	.85	1.10	.67	.94	17.07		
12	630	9135	1/2 NPT	8	10	14	30	39	22,5	34	19	24	11,23	FI-WE-12S1/2N-W3	
	.47			.31	.39	.55	1.18	1.54	.89	1.34	.75	.94	24.70		
14	630	9135	1/2 NPT	10	10	14	30	40	22	34	19	27	8,88	FI-WE-14S1/2N-W3	
	.55			.39	.39	.55	1.18	1.57	.87	1.34	.75	1.06	19.53		
16	630	9135	1/2 NPT	12	12	14	33	43	24,5	36	24	30	14,05	FI-WE-16S1/2N-W3	
	.63			.47	.47	.55	1.30	1.69	.96	1.42	.94	1.18	30.90		
20	400	5800	3/4 NPT	16	16	14	37	48	26,5	42	27	36	19,28	FI-WE-20S3/4N-W3	
	.79			.63	.63	.55	1.46	1.89	1.04	1.65	1.06	1.42	42.42		
25	400	5800	1 NPT	20	20	17,5	42	54	30	48	36	46	33,76	FI-WE-25S1N-W3	
	.98			.79	.79	.69	1.65	2.13	1.18	1.89	1.42	1.81	74.26		
30	400	5800	1 1/4 NPT	25	25	18	49	62	35,5	54	41	50	60,30	FI-WE-30S1-1/4N-W3	
	1.18			.98	.98	.71	1.93	2.44	1.40	2.13	1.61	1.97	132.66		
38	315	4568	1 1/2 NPT	32	32	18,5	58	73	40	61	50	60	91,80	FI-WE-38S1-1/2N-W3	
	1.50			1.26	1.26	.73	2.28	2.87	1.57	2.40	1.97	2.36	201.96		

<sup>1</sup> Approximate dimension in assembled condition.  
<sup>2</sup> Weight excluding cutting ring and union nut.  
<sup>3</sup> Standard scope of delivery: Fitting body only.

Male stud acc. to ANSI/ASME B1.20.1-1983  
 Port acc. to ANSI/ASME B1.20.1-1983  
 Suitable liquid / plastic sealant required.

Male threaded studs were designed for female threaded ports in components made of steel. For applications with components made of softer mating materials (e.g. Aluminium), the use of connectors with additionally rolled male threads is recommended.  
 Please contact STAUFF prior to the assembly for further information.

### Ordering Codes

**\*FI-WE\*-10\*S\*1/4\*N\*-W3\*-MS**

- \* Male Stud Elbow **FI-WE**
- \* Outside Tube Diameter D1 (in mm) **-10**
- \* Series Extra-Light Series (page 80) **LL**  
Light Series (page 80) **L**  
Heavy Series (page 81) **S**
- \* Thread Size acc. to dimension table **1/4**
- Please always indicate thread sizes, e.g. 1/4!
- \* Thread Type NPT Thread **N**
- \* Material Code Steel, zinc/nickel-plated **-W3**
- Please contact STAUFF for alternative materials and surface finishings.
- \* Assembling / Kitting Fitting body only **—**
- Fitting body supplied with cutting ring and union nut **-MS**
- Fitting body supplied with soft-sealing cutting ring and union nut **-MSV**

### Connecting Parts

- Cutting Ring  
Type **FI-DS** Page 28
- Soft-Sealing Cutting Ring  
Type **FI-WDDS** Page 29
- Support Sleeve  
Type **FI-VH** Page 31
- STAUFF Form EVO Sealing Ring  
Type **FI-FD** Page 32
- Union Nut  
Type **FI-M** Page 33
- 37° Flared Tube Fitting Set  
Type **FI-AB** Page 37



**Male Stud Branch Tee**  
Type FI-TE-...-R ▪ Series L / S

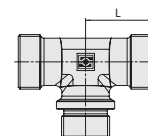
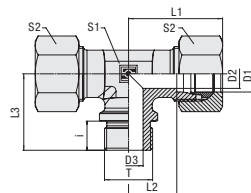

C

**Ordering Codes**

**\*FI-TE\*-22\*L\*R\*-W3\*-MS**

- \* Male Stud Branch Tee **FI-TE**
- \* Outside Tube Diameter D1 (in mm) **-22**
- \* Series **L**  
Light Series  
Heavy Series **S**
- \* Thread Type **R**  
Whitworth Parallel  
Pipe Thread (BSPP)
- If required, please indicate special sizes, e.g. R1/2!
- \* Material Code **-W3**  
Steel, zinc/nickel-plated
- Please contact STAUFF for alternative materials and surface finishings.
- \* Assembling / Kitting **—**  
Fitting body only
- Fitting body supplied with cutting rings and union nuts **-MS**
- Fitting body supplied with soft-sealing cutting rings and union nuts **-MSV**

**Whitworth Parallel Pipe Thread (BSPP)**

**Metallic Sealing Edge**

Series	Tube OD (mm/in)	PN (bar/psi)	Dimensions (mm/in)											Torque (N·m/ft·lb)	Weight (kg/lbs) ca. per 100	Ordering Codes <sup>3</sup>
			D1	Thread	T	D2	D3	i	L	L1 <sup>1</sup>	L2	L3	S1			
L	22	160	G 3/4	19	18	16	35	44	27,5	42	27	36	180	23,90	FI-TE-22LR-W3	
	.87	2320		.75	.71	.63	1.38	1.73	1.08	1.65	1.06	1.42	133.2	52.58		
	28	160	G 1	24	23	18	38	47	30,5	48	36	41	330	37,50	FI-TE-28LR-W3	
	1.10	2320		.94	.91	.71	1.50	1.85	1.20	1.89	1.42	1.61	244.2	82.50		
	35	160	G 1 1/4	30	30	20	45	56	34,5	54	41	50	540	56,50	FI-TE-35LR-W3	
	1.38	2320		1.18	1.18	.79	1.77	2.20	1.36	2.13	1.61	1.97	399.6	124.30		
42	160	G 1 1/2	36	36	22	51	63	40	61	50	60	630	80,50	FI-TE-42LR-W3		
1.65	2320		1.42	1.42	.87	2.01	2.48	1.57	2.40	1.97	2.36	466.2	177.10			
S	20	400	G 3/4	16	16	16	37	48	26,5	42	27	36	270	28,80	FI-TE-20SR-W3	
	.79	5800		.63	.63	.63	1.46	1.89	1.04	1.65	1.06	1.42	199.8	63.36		
	25	250	G 1	20	20	18	42	54	30	48	36	46	340	51,40	FI-TE-25SR-W3	
	.98	3625		.79	.79	.71	1.65	2.13	1.18	1.89	1.42	1.81	251.6	113.08		
	30	160	G 1 1/4	25	25	20	49	62	35,5	54	41	50	540	79,20	FI-TE-30SR-W3	
	1.18	2320		.98	.98	.79	1.93	2.44	1.40	2.13	1.61	1.97	399.6	174.24		
	38	160	G 1 1/2	32	32	22	57	72	41	61	50	60	700	114,50	FI-TE-38SR-W3	
	1.50	2320		1.26	1.26	.87	2.24	2.83	1.61	2.40	1.97	2.36	518.0	251.90		

<sup>1</sup> Approximate dimension in assembled condition.

<sup>2</sup> Weight excluding cutting rings and union nuts.

<sup>3</sup> Standard scope of delivery: Fitting body only.

Male stud acc. to DIN 3852-2 (Form B) / ISO 1179-4 (Type B)  
Port acc. to DIN 3852-2 (Form X) / ISO 1179-1

Torque recommendations for Steel mating material.

Male threaded studs were designed for female threaded ports in components made of steel. For applications with components made of softer mating materials (e.g. Aluminium), the use of connectors with additionally rolled male threads is recommended.

Please contact STAUFF prior to the assembly for further information.

**Connecting Parts**

- Cutting Ring  
Type **FI-DS** Page 28
- Soft-Sealing Cutting Ring  
Type **FI-WDDS** Page 29
- Support Sleeve  
Type **FI-VH** Page 31
- STAUFF Form EVO Sealing Ring  
Type **FI-FD** Page 32
- Union Nut  
Type **FI-M** Page 33
- 37° Flared Tube Fitting Set  
Type **FI-AB** Page 37



Male Stud Branch Tee  
Type FI-TE-...-M • Series L / S

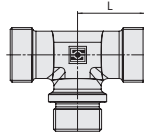
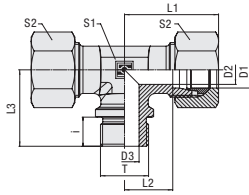

C

Metallic Sealing Edge

Metric Parallel Thread

Series	Tube OD		PN (bar/PSI)	Dimensions (mm/in)										Torque (Nm/ft-lb)	Weight (kg/lbs) ca. per 100	Ordering Codes <sup>3</sup>
	D1	D2		Thread T	D2	D3	i	L	L1 <sup>1</sup>	L2	L3	S1	S2			
L	22	160	M 26 x 1,5	19	18	16	35	44	27,5	42	27	36	190	22,20	FI-TE-22LM-W3	
	.87	2320		.75	.71	.63	1.38	1.73	1.08	1.65	1.06	1.42	140.6	48.84		
	28	160	M 33 x 2	24	23	18	38	47	30,5	48	36	41	340	37,60	FI-TE-28LM-W3	
	1.10	2320		.94	.91	.71	1.50	1.85	1.20	1.89	1.42	1.61	251.6	82.72		
	35	160	M 42 x 2	30	30	20	45	56	34,5	54	41	50	500	56,90	FI-TE-35LM-W3	
	1.38	2320		1.18	1.18	.79	1.77	2.20	1.36	2.13	1.61	1.97	370.0	125.18		
42	160	M 48 x 2	36	36	22	51	63	40	61	50	60	630	81,10	FI-TE-42LM-W3		
1.65	2320		1.42	1.42	.87	2.01	2.48	1.57	2.40	1.97	2.36	466.2	178.42			
S	20	400	M 27 x 2	16	16	16	37	48	26,5	42	27	36	270	29,10	FI-TE-20SM-W3	
	.79	5800		.63	.63	.63	1.46	1.89	1.04	1.65	1.06	1.42	199.8	64.02		
	25	250	M 33 x 2	20	20	18	42	54	30	48	36	46	410	51,10	FI-TE-25SM-W3	
	.98	3625		.79	.79	.71	1.65	2.13	1.18	1.89	1.42	1.81	303.4	112.42		
	30	160	M 42 x 2	25	25	20	49	62	35,5	54	41	50	540	79,60	FI-TE-30SM-W3	
	1.18	2320		.98	.98	.79	1.93	2.44	1.40	2.13	1.61	1.97	399.6	175.12		
38	160	M 48 x 2	32	32	22	57	72	41	61	50	60	700	115,10	FI-TE-38SM-W3		
1.50	2320		1.26	1.26	.87	2.24	2.83	1.61	2.40	1.97	2.36	518.0	253.22			

<sup>1</sup> Approximate dimension in assembled condition.  
<sup>2</sup> Weight excluding cutting rings and union nuts.  
<sup>3</sup> Standard scope of delivery: Fitting body only.

Male stud acc. to DIN 3852-1 (Form B) / ISO 9974-3 (Type B)  
 Port acc. to DIN 3852-1 (Form X) / ISO 9974-1

Torque recommendations for Steel mating material.

Male threaded studs were designed for female threaded ports in components made of steel. For applications with components made of softer mating materials (e.g. Aluminium), the use of connectors with additionally rolled male threads is recommended. Please contact STAUFF prior to the assembly for further information.

Ordering Codes

**\*FI-TE\*-22\*L\*M\*-W3\*-MS**

- \* Male Stud Branch Tee FI-TE
- \* Outside Tube Diameter D1 (in mm) -22
- \* Series Light Series L  
Heavy Series S
- \* Thread Type Metric Parallel Thread M
- If required, please indicate special sizes, e.g. M27x2!
- \* Material Code Steel, zinc/nickel-plated -W3
- Please contact STAUFF for alternative materials and surface finishings.
- \* Assembling / Kitting Fitting body only —  
Fitting body supplied with cutting rings and union nuts -MS  
Fitting body supplied with soft-sealing cutting rings and union nuts -MSV

Connecting Parts

-  Cutting Ring  
Type **FI-DS** Page 28
-  Soft-Sealing Cutting Ring  
Type **FI-WDDS** Page 29
-  Support Sleeve  
Type **FI-VH** Page 31
-  STAUFF Form EVO Sealing Ring  
Type **FI-FD** Page 32
-  Union Nut  
Type **FI-M** Page 33
-  37° Flared Tube Fitting Set  
Type **FI-AB** Page 37



**Male Stud Branch Tee**  
Type FI-TE-...-Rk ▪ Series LL / L / S

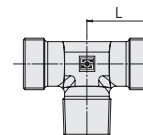
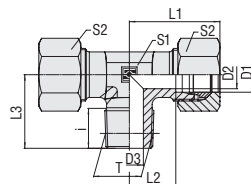

C

**Whitworth Taper Pipe Thread (BSPT)**

**Ordering Codes**

**\*FI-TE\*-10\*L\*Rk\*-W3\*-MS**

- \* Male Stud Branch Tee **FI-TE**
- \* Outside Tube Diameter D1 (in mm) **-10**
- \* Series **LL** Extra-Light Series  
**L** Light Series  
**S** Heavy Series
- \* Thread Type **Rk** Whitworth Taper Pipe Thread (BSPT)
- If required, please indicate special sizes, e.g. R1/8k!
- \* Material Code **-W3** Steel, zinc/nickel-plated
- Please contact STAUFF for alternative materials and surface finishings.
- \* Assembling / Kitting **—** Fitting body only  
**-MS** Fitting body supplied with cutting rings and union nuts  
**-MSV** Fitting body supplied with soft-sealing cutting rings and union nuts

Series	Tube OD		PN	Dimensions										Weight (kg/lbs) ca. per 100	Ordering Codes <sup>3</sup>
	(mm/in)	(mm/in)		(mm/in)	Thread	T	D2	D3	i	L	L1 <sup>1</sup>	L2	L3		
LL	4	100	100	R 1/8 keg.	3	4	8	15	21	11	17	9	10	1,59	FI-TE-04LLRk-W3
	.16	1450			.12	.16	.31	.59	.83	.43	.67	.35	.39	3,50	
	6	100	1450	R 1/8 keg.	4,5	4,5	8	15	21	9,5	17	9	12	1,34	FI-TE-06LLRk-W3
	.24	1450			.18	.18	.31	.59	.83	.37	.67	.35	.47	2,94	
L	8	100	100	R 1/8 keg.	6	6	8	17	23	11,5	20	12	14	1,88	FI-TE-08LLRk-W3
	.31	1450			.24	.24	.31	.67	.91	.45	.79	.47	.55	4,14	
	6	315	4568	R 1/8 keg.	4	4	8	19	27	12	20	12	14	2,73	FI-TE-06LRk-W3
	.24	4568			.16	.16	.31	.75	1.06	.47	.79	.47	.55	6,00	
S	8	315	4568	R 1/4 keg.	6	6	12	21	29	14	26	12	17	3,80	FI-TE-08LRk-W3
	.31	4568			.24	.24	.47	.83	1.14	.55	1.02	.47	.67	8,36	
	10	315	4568	R 1/4 keg.	8	7	12	22	30	15	27	14	19	4,70	FI-TE-10LRk-W3
	.39	4568			.31	.28	.47	.87	1.18	.59	1.06	.55	.75	10,34	
S	12	315	4568	R 1/4 keg.	10	8	15	24	33,5	17	28	17	22	6,02	FI-TE-12LR1/4k-W3
	.47	4568			.39	.31	.59	.94	1.32	.67	1.10	.67	.87	13,27	
	12	315	4568	R 3/8 keg.	10	9	12	24	32	17	28	17	22	6,28	FI-TE-12LRk-W3
	.47	4568			.39	.35	.47	.94	1.26	.67	1.10	.67	.87	13,82	
S	15	315	4568	R 1/2 keg.	12	11	14	28	36	21	34	19	27	11,80	FI-TE-15LRk-W3
	.59	4568			.47	.43	.55	1.10	1.42	.83	1.34	.75	1.06	25,96	
	18	315	4568	R 1/2 keg.	15	14	14	31	40	23,5	36	24	32	16,30	FI-TE-18LRk-W3
	.71	4568			.59	.55	.55	1.22	1.57	.93	1.42	.94	1.26	35,86	
S	6	400	5800	R 1/4 keg.	4	4	12	23	31	16	26	12	17	5,00	FI-TE-06SRk-W3
	.24	5800			.16	.16	.47	.91	1.22	.63	1.02	.47	.67	11,00	
	8	400	5800	R 1/4 keg.	5	5	12	24	32	17	27	14	19	6,27	FI-TE-08SRk-W3
	.31	5800			.20	.20	.47	.94	1.26	.67	1.06	.55	.75	13,80	
S	10	400	5800	R 3/8 keg.	7	7	12	25	34	17,5	28	17	22	8,50	FI-TE-10SRk-W3
	.39	5800			.28	.28	.47	.98	1.34	.69	1.10	.67	.87	18,70	
	12	400	5800	R 3/8 keg.	8	8	12	29	38	21,5	28	17	24	11,60	FI-TE-12SRk-W3
	.47	5800			.31	.31	.47	1.14	1.50	.85	1.10	.67	.94	25,52	
S	14	400	5800	R 1/2 keg.	10	10	14	30	40	22	32	19	27	15,47	FI-TE-14SRk-W3
	.55	5800			.39	.39	.55	1.18	1.57	.87	1.26	.75	1.06	34,03	
	16	400	5800	R 1/2 keg.	12	12	14	33	43	24,5	32	24	30	18,90	FI-TE-16SRk-W3
	.63	5800			.47	.47	.55	1.30	1.69	.96	1.26	.94	1.18	41,58	

**Connecting Parts**

- Cutting Ring  
Type **FI-DS** Page 28
- Soft-Sealing Cutting Ring  
Type **FI-WDDS** Page 29
- Support Sleeve  
Type **FI-VH** Page 31
- STAUFF Form EVO Sealing Ring  
Type **FI-FD** Page 32
- Union Nut  
Type **FI-M** Page 33
- 37° Flared Tube Fitting Set  
Type **FI-AB** Page 37

<sup>1</sup> Approximate dimension in assembled condition.  
<sup>2</sup> Weight excluding cutting rings and union nuts.  
<sup>3</sup> Standard scope of delivery: Fitting body only.

Male stud acc. to DIN 3852-2 (Form C)  
Port acc. to DIN 3852-2 (Form Z)

Suitable liquid / plastic sealant required.

Male threaded studs were designed for female threaded ports in components made of steel. For applications with components made of softer mating materials (e.g. Aluminium), the use of connectors with additionally rolled male threads is recommended.

Please contact STAUFF prior to the assembly for further information.

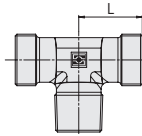
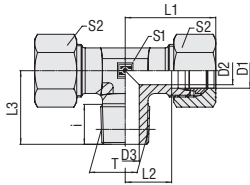

**Male Stud Branch Tee**  
**Type FI-TE-...-Mk ■ Series LL / L / S**

**C**
**Metric Taper Thread**

Series	Tube OD (mm/in)	PN (bar/PSI)	Dimensions (mm/in)										Weight (kg/lbs) ca. per 100	Ordering Codes <sup>3</sup>	
			Thread	T	D2	D3	i	L	L1 <sup>1</sup>	L2	L3	S1			S2
LL	4	100	M 8 x 1 keg.	3	3,5	8	15	21	11	17	9	10	1,27	FI-TE-04LLMk-W3	
	.16	1450		.12	.14	.31	.59	.83	.43	.67	.35	.39	2,79		
	6	100	M 10 x 1 keg.	4,5	4,5	8	15	21	9,5	17	9	12	1,62	FI-TE-06LLMk-W3	
	.24	1450		.18	.18	.31	.59	.83	.37	.67	.35	.47	3,56		
LL	8	100	M 10 x 1 keg.	6	6	8	17	23	11,5	20	12	14	2,42	FI-TE-08LLMk-W3	
	.31	1450		.24	.24	.31	.67	.91	.45	.79	.47	.55	5,31		
L	6	315	M 10 x 1 keg.	4	4	8	19	27	12	20	12	14	2,76	FI-TE-06LMk-W3	
	.24	4568		.16	.16	.31	.75	1.06	.47	.79	.47	.55	6,08		
	8	315	M 12 x 1,5 keg.	6	6	12	21	29	14	26	12	17	3,45	FI-TE-08LMk-W3	
	.31	4568		.24	.24	.47	.83	1.14	.55	1.02	.47	.67	7,59		
	10	315	M 14 x 1,5 keg.	8	7	12	22	30	15	27	14	19	4,72	FI-TE-10LMk-W3	
	.39	4568		.31	.28	.47	.87	1.18	.59	1.06	.55	.75	10,38		
	12	315	M 16 x 1,5 keg.	10	9	12	24	32	17	28	17	22	7,19	FI-TE-12LMk-W3	
	.47	4568		.39	.35	.47	.94	1.26	.67	1.10	.67	.87	15,81		
	15	315	M 18 x 1,5 keg.	12	11	12	28	36	21	32	19	27	11,86	FI-TE-15LMk-W3	
	.59	4568		.47	.43	.47	1.10	1.42	.83	1.26	.75	1.06	26,10		
	18	315	M 22 x 1,5 keg.	15	14	14	31	40	23,5	36	24	32	17,50	FI-TE-18LMk-W3	
	.71	4568		.59	.55	.55	1.22	1.57	.93	1.42	.94	1.26	38,49		
	S	6	400	M 12 x 1,5 keg.	4	4	12	23	31	16	26	12	17	5,57	FI-TE-06SMk-W3
		.24	5800		.16	.16	.47	.91	1.22	.63	1.02	.47	.67	12,26	
8		400	M 14 x 1,5 keg.	5	5	12	24	32	17	27	14	19	7,54	FI-TE-08SMk-W3	
.31		5800		.20	.20	.47	.94	1.26	.67	1.06	.55	.75	16,58		
10		400	M 16 x 1,5 keg.	7	7	12	25	34	17,5	28	17	22	9,38	FI-TE-10SMk-W3	
.39		5800		.28	.28	.47	.98	1.34	.69	1.10	.67	.87	20,64		
12		400	M 18 x 1,5 keg.	8	8	12	29	38	21,5	28	17	24	10,71	FI-TE-12SMk-W3	
.47		5800		.31	.31	.47	1.14	1.50	.85	1.10	.67	.94	23,56		
14		400	M 20 x 1,5 keg.	10	10	14	30	40	22	32	19	27	15,11	FI-TE-14SMk-W3	
.55		5800		.39	.39	.55	1.18	1.57	.87	1.26	.75	1.06	33,25		
16	400	M 22 x 1,5 keg.	12	12	14	33	43	24,5	32	24	30	20,16	FI-TE-16SMk-W3		
.63	5800		.47	.47	.55	1.30	1.69	.96	1.26	.94	1.18	44,35			

<sup>1</sup> Approximate dimension in assembled condition.

<sup>2</sup> Weight excluding cutting rings and union nuts.

<sup>3</sup> Standard scope of delivery: Fitting body only.

 Male stud acc. to DIN 3852-1 (Form C)  
 Port acc. to DIN 3852-1 (Form Z)

Suitable liquid / plastic sealant required.

Male threaded studs were designed for female threaded ports in components made of steel. For applications with components made of softer mating materials (e.g. Aluminium), the use of connectors with additionally rolled male threads is recommended.

Please contact STAUFF prior to the assembly for further information.

**Ordering Codes**
**\*FI-TE\*-10\*L\*Mk\*-W3\*-MS**

* Male Stud Branch Tee	FI-TE
* Outside Tube Diameter D1 (in mm)	-10
* Series	Extra-Light Series <b>LL</b> Light Series <b>L</b> Heavy Series <b>S</b>
* Thread Type	Metric Taper Thread <b>Mk</b>
If required, please indicate special sizes, e.g. M12x1.5 !	
* Material Code	Steel, zinc/nickel-plated <b>-W3</b>
Please contact STAUFF for alternative materials and surface finishings.	
* Assembling / Kitting	Fitting body only <b>—</b>
	Fitting body supplied with cutting rings and union nuts <b>-MS</b>
	Fitting body supplied with soft-sealing cutting rings and union nuts <b>-MSV</b>

**Connecting Parts**

	Cutting Ring Type <b>FI-DS</b>	Page 28
	Soft-Sealing Cutting Ring Type <b>FI-WDDS</b>	Page 29
	Support Sleeve Type <b>FI-VH</b>	Page 31
	STAUFF Form EVO Sealing Ring Type <b>FI-FD</b>	Page 32
	Union Nut Type <b>FI-M</b>	Page 33
	37° Flared Tube Fitting Set Type <b>FI-AB</b>	Page 37



**Male Stud Branch Tee**  
Type FI-TE-...-N • Series LL / L

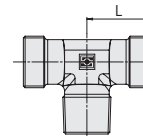
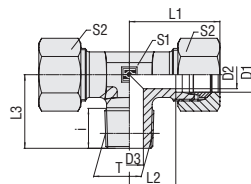

C

**Ordering Codes**

**\*FI-TE\*-10\*L\*1/4N\*-W3\*-MS**

- \* Male Stud Branch Tee **FI-TE**
- \* Outside Tube Diameter D1 (in mm) **-10**
- \* Series **LL**  
 Extra-Light Series (page 86)  
 Light Series (page 86)  
 Heavy Series (page 87) **L**  
**S**
- \* Thread Size **1/4**  
 acc. to dimension table  
 Please always indicate thread sizes, e.g. 1/4!
- \* Thread Type **N**  
 NPT Thread
- \* Material Code **-W3**  
 Steel, zinc/nickel-plated  
 Please contact STAUFF for alternative materials and surface finishings.
- \* Assembling / Kitting **—**  
 Fitting body only  
 Fitting body supplied with cutting rings and union nuts **-MS**  
 Fitting body supplied with soft-sealing cutting rings and union nuts **-MSV**

**Connecting Parts**

-  Cutting Ring  
Type **FI-DS** Page 28
-  Soft-Sealing Cutting Ring  
Type **FI-WDDS** Page 29
-  Support Sleeve  
Type **FI-VH** Page 31
-  STAUFF Form EVO Sealing Ring  
Type **FI-FD** Page 32
-  Union Nut  
Type **FI-M** Page 33
-  37° Flared Tube Fitting Set  
Type **FI-AB** Page 37

**NPT-Thread**

Series	Tube OD PN		Dimensions											Weight (kg/lbs) Ca. per 100	Ordering Codes <sup>3</sup>
	(mm/in) D1	(mm/psi) PN	Thread	T	D2	D3	i	L	L1 <sup>1</sup>	L2	L3	S1	S2		
LL	4	100	1/8 NPT	3	3	7	15	21	11	17	9	10	1,60	FI-TE-04LL1/8N-W3	
	.16	1450	1/8 NPT	.12	.12	.28	.59	.83	.43	.67	.35	.39	3,52		
	6	100	1/8 NPT	4,5	4,5	7	15	21	9,5	17	9	12	1,50		FI-TE-06LL1/8N-W3
	.24	1450	1/8 NPT	.18	.18	.28	.59	.83	.37	.67	.35	.47	3,30		
L	8	100	1/8 NPT	5	5	7	17	23	11,5	20	12	14	2,50	FI-TE-08LL1/8N-W3	
	.31	1450	1/8 NPT	.20	.20	.28	.67	.91	.45	.79	.47	.55	5,50		
	6	315	1/8 NPT	4	4	7	19	27	12	20	12	14	3,00	FI-TE-06L1/8N-W3	
	.24	4568	1/8 NPT	.16	.16	.28	.75	1.06	.47	.79	.47	.55	6,60		
	6	315	1/4 NPT	4	4	10	21	29	14	26	12	14	4,40	FI-TE-06L1/4N-W3	
	.24	4568	1/4 NPT	.16	.16	.39	.83	1.14	.55	1.02	.47	.55	9,68		
	8	315	1/4 NPT	6	6	10	21	29	14	26	12	17	4,20	FI-TE-08L1/4N-W3	
	.31	4568	1/4 NPT	.24	.24	.39	.83	1.14	.55	1.02	.47	.67	9,24		
	10	315	1/4 NPT	7	7	10	22	30	15	27	14	19	5,00	FI-TE-10L1/4N-W3	
	.39	4568	1/4 NPT	.28	.28	.39	.87	1.18	.59	1.06	.55	.75	11,00		
	12	315	3/8 NPT	10	10	10,5	24	32	17	28	17	22	6,50	FI-TE-12L3/8N-W3	
	.47	4568	3/8 NPT	.39	.39	.41	.94	1.26	.67	1.10	.67	.87	14,30		
	15	315	1/2 NPT	12	12	14	28	36	21	36	19	27	12,10	FI-TE-15L1/2N-W3	
	.59	4568	1/2 NPT	.47	.47	.55	1.10	1.42	.83	1.42	.75	1.06	26,62		
	18	315	1/2 NPT	15	12	14	31	40	23,5	36	24	32	16,30	FI-TE-18L1/2N-W3	
	.71	4568	1/2 NPT	.59	.47	.55	1.22	1.57	.93	1.42	.94	1.26	35,86		
	22	160	3/4 NPT	19	18	14	35	44	27,5	42	27	36	21,80	FI-TE-22L3/4N-W3	
	.87	2320	3/4 NPT	.75	.71	.55	1.38	1.73	1.08	1.65	1.06	1.42	47,96		
	28	160	1 NPT	24	21	17,5	38	47	30,5	48	36	41	39,00	FI-TE-28L1N-W3	
	1.10	2320	1 NPT	.94	.83	.69	1.50	1.85	1.20	1.89	1.42	1.61	85,80		
35	160	1 1/4 NPT	30	28	18	46	57	35,5	54	41	50	59,40	FI-TE-35L1-1/4N-W3		
1.38	2320	1 1/4 NPT	1.18	1.10	.71	1.81	2.24	1.40	2.13	1.61	1.97	130,68			
42	160	1 1/2 NPT	36	34	18,5	51	63	40	61	50	60	84,10	FI-TE-42L1-1/2N-W3		
1.65	2320	1 1/2 NPT	1.42	1.34	.73	2.01	2.48	1.57	2.40	1.97	2.36	185,02			

<sup>1</sup> Approximate dimension in assembled condition.

<sup>2</sup> Weight excluding cutting rings and union nuts.

<sup>3</sup> Standard scope of delivery: Fitting body only.

Male stud acc. to ANSI/ASME B1.20.1-1983

Port acc. to ANSI/ASME B1.20.1-1983

Suitable liquid / plastic sealant required.

Male threaded studs were designed for female threaded ports in components made of steel. For applications with components made of softer mating materials (e.g. Aluminium), the use of connectors with additionally rolled male threads is recommended.

Please contact STAUFF prior to the assembly for further information.



Male Stud Branch Tee  
Type FI-TE-...-N • Series S

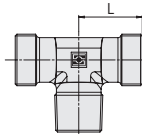
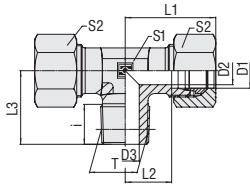

C

NPT Thread

Series	Tube OD (mm/in)	PN (bar/psi)	Dimensions (mm/in)											Weight (kg/lbs) ca. per 100	Ordering Codes <sup>3</sup>
			Thread	T	D2	D3	i	L	L1 <sup>1</sup>	L2	L3	S1	S2		
S	6	630	1/4 NPT	4	4	10	23	31	16	26	12	17	5,50	FI-TE-06S1/4N-W3	
	.24	9135		.16	.16	.39	.91	1.22	.63	1.02	.47	.67	12.10		
	8	630	1/4 NPT	5	5	10	24	32	17	27	14	19	6,80	FI-TE-08S1/4N-W3	
	.31	9135		.20	.20	.39	.94	1.26	.67	1.06	.55	.75	14.96		
	10	630	3/8 NPT	7	7	10,5	25	34	17,5	28	17	22	8,80	FI-TE-10S3/8N-W3	
	.39	9135		.28	.28	.41	.98	1.34	.69	1.10	.67	.87	19.36		
	12	630	3/8 NPT	8	8	10,5	29	38	21,5	28	22	24	11,10	FI-TE-12S3/8N-W3	
	.47	9135		.31	.31	.41	1.14	1.50	.85	1.10	.82	.94	24.42		
	14	630	1/2 NPT	10	10	14	30	40	22	34	19	27	15,10	FI-TE-14S1/2N-W3	
	.55	9135		.39	.39	.55	1.18	1.57	.87	1.34	.75	1.06	33.22		
	16	630	1/2 NPT	12	12	14	33	43	24,5	36	24	30	19,00	FI-TE-16S1/2N-W3	
	.63	9135		.47	.47	.55	1.30	1.69	.96	1.42	.94	1.18	41.80		
	20	400	3/4 NPT	16	16	14	37	48	26,5	42	27	36	28,20	FI-TE-20S3/4N-W3	
	.79	5800		.63	.63	.55	1.46	1.89	1.04	1.65	1.06	1.42	62.04		
	25	400	1 NPT	20	20	17,5	42	54	30	48	36	46	50,40	FI-TE-25S1N-W3	
	.98	5800		.79	.79	.69	1.65	2.13	1.18	1.89	1.42	1.81	110.88		
	30	400	1 1/4 NPT	25	25	18	49	62	35,5	54	41	50	78,20	FI-TE-30S1-1/4N-W3	
	1.18	5800		.98	.98	.71	1.93	2.44	1.40	2.13	1.61	1.97	172.04		
	38	400	1 1/2 NPT	32	32	18,5	57	72	41	61	50	60	113,30	FI-TE-38S1-1/2N-W3	
	1.50	5800		1.26	1.26	.73	2.24	2.83	1.61	2.40	1.97	2.36	249.26		

<sup>1</sup> Approximate dimension in assembled condition.

<sup>2</sup> Weight excluding cutting rings and union nuts.

<sup>3</sup> Standard scope of delivery: Fitting body only.

Male stud acc. to ANSI/ASME B1.20.1-1983

Port acc. to ANSI/ASME B1.20.1-1983

Suitable liquid / plastic sealant required.

Male threaded studs were designed for female threaded ports in components made of steel. For applications with components made of softer mating materials (e.g. Aluminium), the use of connectors with additionally rolled male threads is recommended.

Please contact STAUFF prior to the assembly for further information.

### Ordering Codes

**\*FI-TE\*-10\*S\*3/8N\*-W3\*-MS**

- \* Male Stud Branch Tee **FI-TE**
- \* Outside Tube Diameter D1 (in mm) **-10**
- \* Series  
 Extra-Light Series (page 86) **LL**  
 Light Series (page 86) **L**  
 Heavy Series (page 87) **S**
- \* Thread Size acc. to dimension table **3/8**
- Please always indicate thread sizes, e.g. 1/4!
- \* Thread Type NPT Thread **N**
- \* Material Code Steel, zinc/nickel-plated **-W3**
- Please contact STAUFF for alternative materials and surface finishings.
- \* Assembling / Kitting Fitting body only **—**
- Fitting body supplied with cutting rings and union nuts **-MS**
- Fitting body supplied with soft-sealing cutting rings and union nuts **-MSV**

### Connecting Parts

- Cutting Ring  
Type **FI-DS** Page 28
- Soft-Sealing Cutting Ring  
Type **FI-WDDS** Page 29
- Support Sleeve  
Type **FI-VH** Page 31
- STAUFF Form EVO Sealing Ring  
Type **FI-FD** Page 32
- Union Nut  
Type **FI-M** Page 33
- 37° Flared Tube Fitting Set  
Type **FI-AB** Page 37



**Male Stud Barrel Tee**  
Type FI-LE-...-R • Series L / S

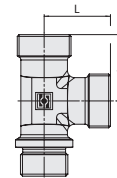
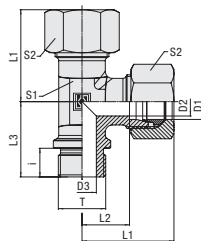

C

**Ordering Codes**

**\*FI-LE\*-22\*L\*R\*-W3\*-MS**

- \* Male Stud Barrel Tee FI-LE
- \* Outside Tube Diameter D1 (in mm) -22
- \* Series L  
S
  - Light Series
  - Heavy Series
- \* Thread Type R
  - Whitworth Parallel Pipe Thread (BSPP)
- If required, please indicate special sizes, e.g. R1/2!
- \* Material Code -W3
  - Steel, zinc/nickel-plated
- Please contact STAUFF for alternative materials and surface finishings.
- \* Assembling / Kitting —
  - Fitting body only
  - Fitting body supplied with cutting rings and union nuts -MS
  - Fitting body supplied with soft-sealing cutting rings and union nuts -MSV

**Whitworth Parallel Pipe Thread (BSPP)**

**Metallic Sealing Edge**

Series	Tube OD (mm/in)	PN (bar/psi)	Dimensions (mm/in)												Torque (N·m/ft·lb)	Weight (kg/lbs) ca. per 100	Ordering Codes <sup>3</sup>
			D1	Thread	T	D2	D3	i	L	L1 <sup>1</sup>	L2	L3	S1	S2			
L	22	160	G 3/4	18	18	16	35	44	27,5	42	27	36	180	25,01	FI-LE-22LR-W3		
	.87	2320		.71	.71	.63	1.38	1.73	1.08	1.65	1.06	1.42	133.2	55.01			
	28	160	G 1	23	23	18	38	47	30,5	48	36	41	330	40,60	FI-LE-28LR-W3		
	1.10	2320		.91	.91	.71	1.50	1.85	1.20	1.89	1.42	1.61	244.2	89.32			
	35	160	G 1 1/4	30	30	20	45	56	34,5	54	41	50	540	61,96	FI-LE-35LR-W3		
	1.38	2320		1.18	1.18	.79	1.77	2.20	1.36	2.13	1.61	1.97	399.6	136.32			
42	160	G 1 1/2	36	36	22	51	63	40	61	50	60	630	100,41	FI-LE-42LR-W3			
1.65	2320		1.42	1.42	.87	2.01	2.48	1.57	2.40	1.97	2.36	466.2	220.90				
S	20	400	G 3/4	16	16	16	37	48	26,5	42	27	36	270	31,72	FI-LE-20SR-W3		
	.79	5800		.63	.63	.63	1.46	1.89	1.04	1.65	1.06	1.42	199.8	69.78			
	25	250	G 1	20	20	18	42	54	30	48	36	46	340	54,62	FI-LE-25SR-W3		
	.98	3625		.79	.79	.71	1.65	2.13	1.18	1.89	1.42	1.81	251.6	120.16			
	30	160	G 1 1/4	25	25	20	49	62	35,5	54	41	50	540	52,00	FI-LE-30SR-W3		
	1.18	2320		.98	.98	.79	1.93	2.44	1.40	2.13	1.61	1.97	399.6	114.40			
38	160	G 1 1/2	32	32	22	57	72	41	61	50	60	700	134,44	FI-LE-38SR-W3			
1.50	2320		1.26	1.26	.87	2.24	2.83	1.61	2.40	1.97	2.36	518.0	295.76				

<sup>1</sup> Approximate dimension in assembled condition.

<sup>2</sup> Weight excluding cutting rings and union nuts.

<sup>3</sup> Standard scope of delivery: Fitting body only.

Male stud acc. to DIN 3852-2 (Form B) / ISO 1179-4 (Type B)  
Port acc. to DIN 3852-2 (Form X) / ISO 1179-1

Torque recommendations for Steel mating material.

Male threaded studs were designed for female threaded ports in components made of steel. For applications with components made of softer mating materials (e.g. Aluminium), the use of connectors with additionally rolled male threads is recommended.

Please contact STAUFF prior to the assembly for further information.

**Connecting Parts**

-  Cutting Ring Type **FI-DS** Page 28
-  Soft-Sealing Cutting Ring Type **FI-WDDS** Page 29
-  Support Sleeve Type **FI-VH** Page 31
-  STAUFF Form EVO Sealing Ring Type **FI-FD** Page 32
-  Union Nut Type **FI-M** Page 33
-  37° Flared Tube Fitting Set Type **FI-AB** Page 37





Male Stud Barrel Tee  
Type FI-LE-...-M • Series L / S

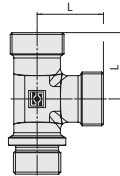
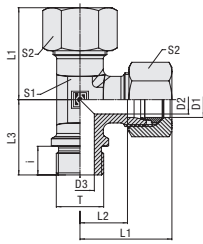

C

Metallic Sealing Edge

Metric Parallel Thread

Series	Tube OD (mm/in)	PN (bar/PSI)	Dimensions (mm/in)											Torque (Nm/ft-lb)	Weight (kg/lbs) ca. per 100	Ordering Codes <sup>3</sup>
			D1	Thread T	D2	D3	i	L	L1 <sup>1</sup>	L2	L3	S1	S2			
L	22	160	M 26 x 1,5	18	18	16	35	44	27,5	42	27	36	190	25,01	FI-LE-22LM-W3	
	.87	2320		.71	.71	.63	1.38	1.73	1.08	1.65	1.06	1.42	140.6	55.01		
	28	160	M 33 x 2	23	23	18	38	47	30,5	48	27	41	340	40,60	FI-LE-28LM-W3	
	1.10	2320		.91	.91	.71	1.50	1.85	1.20	1.89	1.06	1.61	251.6	89.32		
	35	160	M 42 x 2	30	30	20	45	56	34,5	54	41	50	500	61,96	FI-LE-35LM-W3	
	1.38	2320		1.18	1.18	.79	1.77	2.20	1.36	2.13	1.61	1.97	370.0	136.32		
42	160	M 48 x 2	36	36	22	51	63	40	61	50	60	630	100,41	FI-LE-42LM-W3		
1.65	2320		1.42	1.42	.87	2.01	2.48	1.57	2.40	1.97	2.36	466.2	220.90			
S	20	400	M 27 x 2	16	16	16	37	48	26,5	42	27	36	270	31,72	FI-LE-20SM-W3	
	.79	5800		.63	.63	.63	1.46	1.89	1.04	1.65	1.06	1.42	199.8	69.78		
	25	250	M 33 x 2	20	20	18	42	54	30	48	36	46	410	54,62	FI-LE-25SM-W3	
	.98	3625		.79	.79	.71	1.65	2.13	1.18	1.89	1.42	1.81	303.4	120.16		
	30	160	M 42 x 2	25	25	20	49	62	35,5	54	41	50	540	52,00	FI-LE-30SM-W3	
	1.18	2320		.98	.98	.79	1.93	2.44	1.40	2.13	1.61	1.97	399.6	114.40		
	38	160	M 48 x 2	32	32	22	57	72	41	61	50	60	700	134,44	FI-LE-38SM-W3	
	1.50	2320		1.26	1.26	.87	2.24	2.83	1.61	2.40	1.97	2.36	518.0	295.76		

<sup>1</sup> Approximate dimension in assembled condition.

<sup>2</sup> Weight excluding cutting rings and union nuts.

<sup>3</sup> Standard scope of delivery: Fitting body only.

Male stud acc. to DIN 3852-1 (Form B) / ISO 9974-3 (Type B)  
Port acc. to DIN 3852-1 (Form X) / ISO 9974-1

Torque recommendations for Steel mating material.

Male threaded studs were designed for female threaded ports in components made of steel. For applications with components made of softer mating materials (e.g. Aluminium), the use of connectors with additionally rolled male threads is recommended.

Please contact STAUFF prior to the assembly for further information.

Ordering Codes

**\*FI-LE\*-22\*L\*M\*-W3\*-MS**

* Male Stud Barrel Tee	FI-LE
* Outside Tube Diameter D1 (in mm)	-22
* Series	Light Series L Heavy Series S
* Thread Type	Metric Parallel Thread M
If required, please indicate special sizes, e.g. M27x2!	
* Material Code	Steel, zinc/nickel-plated -W3
Please contact STAUFF for alternative materials and surface finishings.	
* Assembling / Kitting	Fitting body only —
	Fitting body supplied with cutting rings and union nuts -MS
	Fitting body supplied with soft-sealing cutting rings and union nuts -MSV

Connecting Parts

	Cutting Ring Type FI-DS	Page 28
	Soft-Sealing Cutting Ring Type FI-WDDS	Page 29
	Support Sleeve Type FI-VH	Page 31
	STAUFF Form EVO Sealing Ring Type FI-FD	Page 32
	Union Nut Type FI-M	Page 33
	37° Flared Tube Fitting Set Type FI-AB	Page 37



**Male Stud Barrel Tee**  
Type FI-LE-...-Rk ▪ Series LL / L / S

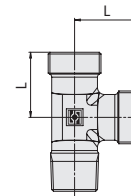
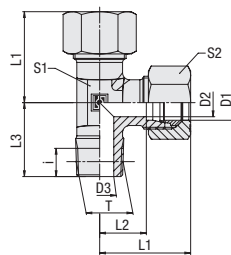

C

**Whitworth Taper Pipe Thread (BSPT)**

**Ordering Codes**

**\*FI-LE\*-10\*L\*Rk\*-W3\*-MS**

- \* Male Stud Barrel Tee **FI-LE**
- \* Outside Tube Diameter D1 (in mm) **-10**
- \* Series **LL** Extra-Light Series  
**L** Light Series  
**S** Heavy Series
- \* Thread Type **Rk** Whitworth Taper Pipe Thread (BSPT)
- If required, please indicate special sizes, e.g. R1/8k!
- \* Material Code **-W3** Steel, zinc/nickel-plated
- Please contact STAUFF for alternative materials and surface finishings.
- \* Assembling / Kitting **—** Fitting body only  
**-MS** Fitting body supplied with cutting rings and union nuts  
**-MSV** Fitting body supplied with soft-sealing cutting rings and union nuts

Series	Tube OD (mm/in)	PN (bar/psi)	Dimensions (mm/in)											Weight (kg/lbs) ca. per 100	Ordering Codes <sup>3</sup>
			D1	Thread	T	D2	D3	i	L	L1 <sup>1</sup>	L2	L3	S1		
LL	4	100	R 1/8 keg.	3	4	8	15	21	11	17	9	10	1,50	FI-LE-04LLRk-W3	
	.16	1450		.12	.16	.31	.59	.83	.43	.67	.35	.39	3,30		
	6	100	R 1/8 keg.	4,5	5	8	16	21	9,5	17	9	12	1,60	FI-LE-06LLRk-W3	
	.24	1450		.18	.20	.31	.63	.83	.37	.67	.35	.47	3,52		
L	8	100	R 1/8 keg.	6	6	8	17	23	11,5	20	12	14	2,42	FI-LE-08LLRk-W3	
	.31	1450		.24	.24	.31	.67	.91	.45	.79	.47	.55	5,31		
	6	315	R 1/8 keg.	4	4	8	19	27	12	20	12	14	3,43	FI-LE-06LRk-W3	
	.24	4568		.16	.16	.31	.75	1.06	.47	.79	.47	.55	94,60		
Rk	8	315	R 1/4 keg.	6	6	12	21	29	14	26	12	17	3,79	FI-LE-08LRk-W3	
	.31	4568		.24	.24	.47	.83	1.14	.55	1.02	.47	.67	8,34		
	10	315	R 1/4 keg.	8	7	12	22	30	15	27	14	19	5,20	FI-LE-10LRk-W3	
	.39	4568		.31	.28	.47	.87	1.18	.59	1.06	.55	.75	11,44		
S	12	315	R 3/8 keg.	10	9	12	24	32	17	28	17	22	6,34	FI-LE-12LRk-W3	
	.47	4568		.39	.35	.47	.94	1.26	.67	1.10	.67	.87	13,95		
	15	315	R 1/2 keg.	12	11	14	28	36	21	34	19	27	11,50	FI-LE-15LRk-W3	
	.59	4568		.47	.43	.55	1.10	1.42	.83	1.34	.75	1.06	25,30		
MS	18	315	R 1/2 keg.	15	14	14	31	40	23,5	36	24	32	14,48	FI-LE-18LRk-W3	
	.71	4568		.59	.55	.55	1.22	1.57	.93	1.42	.94	1.26	31,86		
	6	400	R 1/4 keg.	4	4	12	23	31	16	26	12	17	5,03	FI-LE-06SRk-W3	
	.24	5800		.16	.16	.47	.91	1.22	.63	1.02	.47	.67	11,07		
MSV	8	400	R 1/4 keg.	5	5	12	24	32	17	27	14	19	6,41	FI-LE-08SRk-W3	
	.31	5800		.20	.20	.47	.94	1.26	.67	1.06	.55	.75	14,10		
	10	400	R 3/8 keg.	7	7	12	25	34	17,5	28	17	22	8,33	FI-LE-10SRk-W3	
	.39	5800		.28	.28	.47	.98	1.34	.69	1.10	.67	.87	18,33		
MSV	12	400	R 3/8 keg.	8	8	12	29	38	21,5	28	17	24	10,46	FI-LE-12SRk-W3	
	.47	5800		.31	.31	.47	1.14	1.50	.85	1.10	.67	.94	23,00		
	14	400	R 1/2 keg.	10	10	14	30	40	22	32	19	27	13,91	FI-LE-14SRk-W3	
	.55	5800		.39	.39	.55	1.18	1.57	.87	1.26	.75	1.06	30,60		
MSV	16	400	R 1/2 keg.	12	12	14	33	43	24,5	32	24	30	17,66	FI-LE-16SRk-W3	
	.63	5800		.47	.47	.55	1.30	1.69	.96	1.26	.94	1.18	38,85		

**Connecting Parts**

- Cutting Ring  
Type **FI-DS** Page 28
- Soft-Sealing Cutting Ring  
Type **FI-WDDS** Page 29
- Support Sleeve  
Type **FI-VH** Page 31
- STAUFF Form EVO Sealing Ring  
Type **FI-FD** Page 32
- Union Nut  
Type **FI-M** Page 33
- 37° Flared Tube Fitting Set  
Type **FI-AB** Page 37

<sup>1</sup> Approximate dimension in assembled condition.  
<sup>2</sup> Weight excluding cutting rings and union nuts.  
<sup>3</sup> Standard scope of delivery: Fitting body only.

Male stud acc. to DIN 3852-2 (Form C)  
Port acc. to DIN 3852-2 (Form Z)

Suitable liquid / plastic sealant required.

Male threaded studs were designed for female threaded ports in components made of steel. For applications with components made of softer mating materials (e.g. Aluminium), the use of connectors with additionally rolled male threads is recommended.  
Please contact STAUFF prior to the assembly for further information.



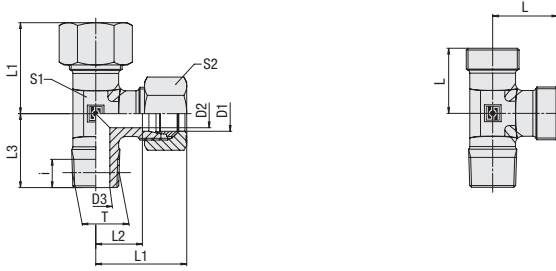

Male Stud Barrel Tee  
Type FI-LE-...-Mk ▪ Series LL / L / S



C

Metric Taper Thread

Series	Tube OD (mm/in)	PN (bar/PSI)	Dimensions (mm/in)										Weight (kg/lbs) ca. per 100	Ordering Codes <sup>3</sup>	
			Thread	T	D2	D3	i	L	L1 <sup>1</sup>	L2	L3	S1			S2
LL	4	100	M 8 x 1 keg.	3	3,5	8	15	21	11	17	9	10	1,50	FI-LE-04LLMk-W3	
	.16	1450		.12	.14	.31	.59	.83	.43	.67	.35	.39	3,30		
	6	100	M 10 x 1 keg.	4,5	4,5	8	15	21	9,5	17	9	12	1,62	FI-LE-06LLMk-W3	
	.24	1450		.18	.18	.31	.59	.83	.37	.67	.35	.47	3,56		
L	8	100	M 10 x 1 keg.	6	6	8	17	23	11,5	20	12	14	2,42	FI-LE-08LLMk-W3	
	.31	1450		.24	.24	.31	.67	.91	.45	.79	.47	.55	5,31		
	6	315	M 10 x 1 keg.	4	4	8	19	27	12	20	12	14	3,43	FI-LE-06LMk-W3	
	.24	4568		.16	.16	.31	.75	1.06	.47	.79	.47	.55	7,54		
S	8	315	M 12 x 1,5 keg.	6	6	12	21	29	14	26	12	17	4,24	FI-LE-08LMk-W3	
	.31	4568		.24	.24	.47	.83	1.14	.55	1.02	.47	.67	9,34		
	10	315	M 14 x 1,5 keg.	8	7	12	22	30	15	27	14	19	5,57	FI-LE-10LMk-W3	
	.39	4568		.31	.28	.47	.87	1.18	.59	1.06	.55	.75	12,25		
	12	315	M 16 x 1,5 keg.	10	9	12	24	32	17	28	17	22	7,19	FI-LE-12LMk-W3	
	.47	4568		.39	.35	.47	.94	1.26	.67	1.10	.67	.87	15,81		
	15	315	M 18 x 1,5 keg.	12	11	12	28	36	21	32	19	27	11,86	FI-LE-15LMk-W3	
	.59	4568		.47	.43	.47	1.10	1.42	.83	1.26	.75	1.06	26,10		
	18	315	M 22 x 1,5 keg.	15	14	14	31	40	23,5	36	24	32	17,50	FI-LE-18LMk-W3	
	.71	4568		.59	.55	.55	1.22	1.57	.93	1.42	.94	1.26	38,49		
	S	6	400	M 12 x 1,5 keg.	4	4	12	23	31	16	26	12	17	5,57	FI-LE-06SMk-W3
		.24	5800		.16	.16	.47	.91	1.22	.63	1.02	.47	.67	12,26	
8		400	M 14 x 1,5 keg.	5	5	12	24	32	17	27	14	19	7,54	FI-LE-08SMk-W3	
.31		5800		.20	.20	.47	.94	1.26	.67	1.06	.55	.75	16,58		
10		400	M 16 x 1,5 keg.	7	7	12	25	34	17,5	28	17	22	8,37	FI-LE-10SMk-W3	
.39		5800		.28	.28	.47	.98	1.34	.69	1.10	.67	.87	18,42		
12		400	M 18 x 1,5 keg.	8	8	12	29	38	21,5	28	17	24	12,07	FI-LE-12SMk-W3	
.47		5800		.31	.31	.47	1.14	1.50	.85	1.10	.67	.94	26,55		
14		400	M 20 x 1,5 keg.	10	10	14	30	40	22	32	19	27	15,11	FI-LE-14SMk-W3	
.55		5800		.39	.39	.55	1.18	1.57	.87	1.26	.75	1.06	33,25		
16	400	M 22 x 1,5 keg.	12	12	14	33	43	24,5	32	24	30	20,16	FI-LE-16SMk-W3		
.63	5800		.47	.47	.55	1.30	1.69	.96	1.26	.94	1.18	44,35			

<sup>1</sup> Approximate dimension in assembled condition.  
<sup>2</sup> Weight excluding cutting rings and union nuts.  
<sup>3</sup> Standard scope of delivery: Fitting body only.

Male stud acc. to DIN 3852-1 (Form C)  
 Port acc. to DIN 3852-1 (Form Z)

Suitable liquid / plastic sealant required.

Male threaded studs were designed for female threaded ports in components made of steel. For applications with components made of softer mating materials (e.g. Aluminium), the use of connectors with additionally rolled male threads is recommended.  
 Please contact STAUFF prior to the assembly for further information.

### Ordering Codes

**\*FI-LE\*-10\*L\*Mk\*-W3\*-MS**

- \* Male Stud Barrel Tee **FI-LE**
- \* Outside Tube Diameter D1 (in mm) **-10**
- \* Series: Extra-Light Series **LL**, Light Series **L**, Heavy Series **S**
- \* Thread Type: Metric Taper Thread **Mk**

If required, please indicate special sizes, e.g. M12x1.5 !

- \* Material Code: Steel, zinc/nickel-plated **-W3**

Please contact STAUFF for alternative materials and surface finishings.

- \* Assembling / Kitting: Fitting body only **—**
- Fitting body supplied with cutting rings and union nuts **-MS**
- Fitting body supplied with soft-sealing cutting rings and union nuts **-MSV**

### Connecting Parts

- Cutting Ring Type **FI-DS** Page 28
- Soft-Sealing Cutting Ring Type **FI-WDDS** Page 29
- Support Sleeve Type **FI-VH** Page 31
- STAUFF Form EVO Sealing Ring Type **FI-FD** Page 32
- Union Nut Type **FI-M** Page 33
- 37° Flared Tube Fitting Set Type **FI-AB** Page 37



**Male Stud Barrel Tee**  
Type FI-LE-...-N • Series LL / L

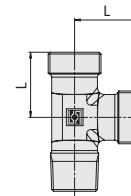
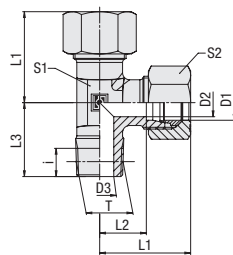

C

**NPT-Thread**

**Ordering Codes**

**\*FI-LE\*-10\*L\*1/4N\*-W3\*-MS**

- \* Male Stud Barrel Tee **FI-LE**
- \* Outside Tube Diameter D1 (in mm) **-10**
- \* Series **LL**  
 Extra-Light Series (page 92)  
 Light Series (page 92)  
 Heavy Series (page 93) **L**  
**S**
- \* Thread Size **1/4**  
 acc. to dimension table  
 Please always indicate thread sizes, e.g. 1/4!
- \* Thread Type **N**  
 NPT Thread
- \* Material Code **-W3**  
 Steel, zinc/nickel-plated  
 Please contact STAUFF for alternative materials and surface finishings.
- \* Assembling / Kitting **—**  
 Fitting body only  
 Fitting body supplied with cutting rings and union nuts **-MS**  
 Fitting body supplied with soft-sealing cutting rings and union nuts **-MSV**

Series	Tube OD (mm/in)	PN (PSI/PS)	Dimensions (mm/in)											Weight (kg/lbs) Ca. per 100	Ordering Codes <sup>3</sup>
			D1	Thread	T	D2	D3	i	L	L1 <sup>1</sup>	L2	L3	S1		
LL	4	100	1/8 NPT	3	3	7	15	21	11	15	9	10	1,51	FI-LE-04LL1/8N-W3	
	.16	1450		.12	.12	.28	.59	.83	.43	.59	.35	.39	3.32		
	6	100	1/8 NPT	4,5	4,5	7	15	21	9,5	15	10	12	1,62	FI-LE-06LL1/8N-W3	
	.24	1450		.18	.18	.28	.59	.83	.37	.59	.39	.47	3.56		
LL	8	100	1/8 NPT	5	5	7	17	23	11,5	20	12	14	3,30	FI-LE-08LL1/8N-W3	
	.31	1450		.20	.20	.28	.67	.91	.45	.79	.47	.55	7.26		
	L	6	315	1/8 NPT	4	4	7	19	27	12	20	12	14	1,30	FI-LE-06L1/8N-W3
		.24	4568		.16	.16	.28	.75	1.06	.47	.79	.47	.55	2.86	
8		315	1/4 NPT	6	6	10	21	29	14	26	12	17	4,24	FI-LE-08L1/4N-W3	
.31		4568		.24	.24	.39	.83	1.14	.55	1.02	.47	.67	9.33		
10		315	1/4 NPT	7	7	10	22	30	15	27	14	19	5,57	FI-LE-10L1/4N-W3	
.39		4568		.28	.28	.39	.87	1.18	.59	1.06	.55	.75	12.25		
12		315	3/8 NPT	10	10	10,5	24	32	17	28	17	22	7,19	FI-LE-12L3/8N-W3	
.47		4568		.39	.39	.41	.94	1.26	.67	1.10	.67	.87	15.81		
15		315	1/2 NPT	12	12	14	28	36	21	34	19	27	11,86	FI-LE-15L1/2N-W3	
.59		4568		.47	.47	.55	1.10	1.42	.83	1.34	.75	1.06	26.10		
18		315	1/2 NPT	14	14	14	31	40	23,5	36	24	32	17,50	FI-LE-18L1/2N-W3	
.71		4568		.55	.55	.55	1.22	1.57	.93	1.42	.94	1.26	38.49		
22		160	3/4 NPT	18	18	14	35	44	27,5	42	27	36	27,60	FI-LE-22L3/4N-W3	
.87		2320		.71	.71	.55	1.38	1.73	1.08	1.65	1.06	1.42	60.72		
28		160	1 NPT	24	24	17,5	38	47	30,5	48	36	41	43,00	FI-LE-28L1N-W3	
1.10		2320		.94	.94	.69	1.50	1.85	1.20	1.89	1.42	1.61	94.60		
35	160	1 1/4 NPT	30	30	18	46	57	35,5	54	41	50	63,50	FI-LE-35L1-1/4N-W3		
1.38	2320		1.18	1.18	.71	1.81	2.24	1.40	2.13	1.61	1.97	139.70			
42	160	1 1/2 NPT	36	36	18	51	63	40	61	50	60	110,00	FI-LE-42L1-1/2N-W3		
1.65	2320		1.42	1.42	.71	2.01	2.48	1.57	2.40	1.97	2.36	242.00			

**Connecting Parts**

- Cutting Ring  
Type **FI-DS** Page 28
- Soft-Sealing Cutting Ring  
Type **FI-WDDS** Page 29
- Support Sleeve  
Type **FI-VH** Page 31
- STAUFF Form EVO Sealing Ring  
Type **FI-FD** Page 32
- Union Nut  
Type **FI-M** Page 33
- 37° Flared Tube Fitting Set  
Type **FI-AB** Page 37

<sup>1</sup> Approximate dimension in assembled condition.  
<sup>2</sup> Weight excluding cutting rings and union nuts.  
<sup>3</sup> Standard scope of delivery: Fitting body only.

Male stud acc. to ANSI/ASME B1.20.1-1983  
 Port acc. to ANSI/ASME B1.20.1-1983

Suitable liquid / plastic sealant required.

Male threaded studs were designed for female threaded ports in components made of steel. For applications with components made of softer mating materials (e.g. Aluminium), the use of connectors with additionally rolled male threads is recommended.  
 Please contact STAUFF prior to the assembly for further information.



Male Stud Barrel Tee  
Type FI-LE-...-N • Series S

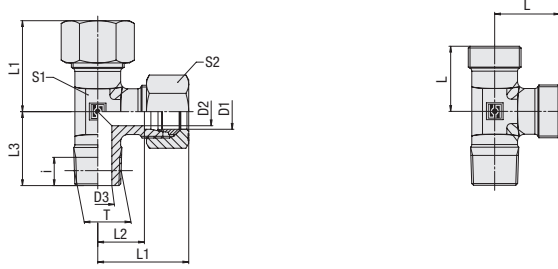

C

NPT Thread

Series	Tube OD PN		Dimensions										Weight ( <sup>kg</sup> /lbs) ca. per 100	Ordering Codes <sup>3</sup>
	(mm/in)	(bar/psi)	Thread	T	D2	D3	i	L	L1 <sup>1</sup>	L2	L3	S1		
S	6	630	1/4 NPT	4	4	10	23	31	16	26	12	17	5,57	FI-LE-06S1/4N-W3
	.24	9135		0.16	0.16	0.39	0.91	1.22	0.63	1.02	0.47	0.67	12.26	
	8	630	1/4 NPT	5	5	10	24	32	17	27	14	19	7,54	FI-LE-08S1/4N-W3
	.31	9135		0.20	0.20	0.39	0.94	1.26	0.67	1.06	0.55	0.75	16.58	
	10	630	3/8 NPT	7	7	10,5	25	34	17,5	28	17	22	10,50	FI-LE-10S3/8N-W3
	.39	9135		0.28	0.28	0.41	0.98	1.34	0.69	1.10	0.67	0.87	23.10	
	12	630	3/8 NPT	8	8	10,5	29	38	21,5	28	17	24	12,07	FI-LE-12S3/8N-W3
	.47	9135		0.31	0.31	0.41	1.14	1.50	0.85	1.10	0.67	0.94	26.55	
	14	630	1/2 NPT	10	10	14	30	40	22	34	19	27	15,11	FI-LE-14S1/2N-W3
	.55	9135		0.39	0.39	0.55	1.18	1.57	0.87	1.34	0.75	1.06	33.25	
	16	630	1/2 NPT	12	12	14	33	43	24,5	36	24	30	20,16	FI-LE-16S1/2N-W3
	.63	9135		0.47	0.47	0.55	1.30	1.69	0.96	1.42	0.94	1.18	44.35	
	20	400	3/4 NPT	16	16	14	37	48	26,5	42	27	36	35,00	FI-LE-20S3/4N-W3
	.79	5800		0.63	0.63	0.55	1.46	1.89	1.04	1.65	1.06	1.42	77.00	
	25	400	1 NPT	20	20	17,5	42	54	30	48	36	46	56,00	FI-LE-25S1N-W3
	.98	5800		0.79	0.79	0.69	1.65	2.13	1.18	1.89	1.42	1.81	123.20	
	30	400	1 1/4 NPT	25	32	18	49	62	35,5	54	41	50	74,20	FI-LE-30S1-1/4N-W3
	1.18	5800		0.98	1.26	0.71	1.93	2.44	1.40	2.13	1.61	1.97	163.24	
	38	400	1 1/2 NPT	32	32	18	57	72	41	61	50	60	145,00	FI-LE-38S1-1/2N-W3
	1.50	5800		1.26	1.26	0.71	2.24	2.83	1.61	2.40	1.97	2.36	319.00	

<sup>1</sup> Approximate dimension in assembled condition.  
<sup>2</sup> Weight excluding cutting rings and union nuts.  
<sup>3</sup> Standard scope of delivery: Fitting body only.

Male stud acc. to ANSI/ASME B1.20.1-1983  
 Port acc. to ANSI/ASME B1.20.1-1983  
 Suitable liquid / plastic sealant required.

Male threaded studs were designed for female threaded ports in components made of steel. For applications with components made of softer mating materials (e.g. Aluminium), the use of connectors with additionally rolled male threads is recommended. Please contact STAUFF prior to the assembly for further information.

### Ordering Codes

**\*FI-LE\*-10\*S\*3/8N\*-W3\*-MS**



- \* Male Stud Barrel Tee **FI-LE**
- \* Outside Tube Diameter D1 (in mm) **-10**
- \* Series: Extra-Light Series (page 92) **LL**, Light Series (page 92) **L**, Heavy Series (page 93) **S**
- \* Thread Size: acc. to dimension table **3/8**
- Please always indicate thread sizes, e.g. 1/4!
- \* Thread Type: NPT Thread **N**
- \* Material Code: Steel, zinc/nickel-plated **-W3**
- Please contact STAUFF for alternative materials and surface finishings.
- \* Assembling / Kitting: Fitting body only **—**
- Fitting body supplied with cutting rings and union nuts **-MS**
- Fitting body supplied with soft-sealing cutting rings and union nuts **-MSV**

### Connecting Parts

- Cutting Ring Type **FI-DS** Page 28
- Soft-Sealing Cutting Ring Type **FI-WDDS** Page 29
- Support Sleeve Type **FI-VH** Page 31
- STAUFF Form EVO Sealing Ring Type **FI-FD** Page 32
- Union Nut Type **FI-M** Page 33
- 37° Flared Tube Fitting Set Type **FI-AB** Page 37





	<b>Straight Union</b> FI-G	96
	<b>Straight Reducer</b> FI-G	97
	<b>Equal Elbow</b> FI-W	99
	<b>Equal Tee</b> FI-T	100
	<b>Tee Reducer</b> FI-T	101
	<b>Equal Cross</b> FI-K	104

D



**Straight Union**  
Type FI-G ▪ Series LL / L / S

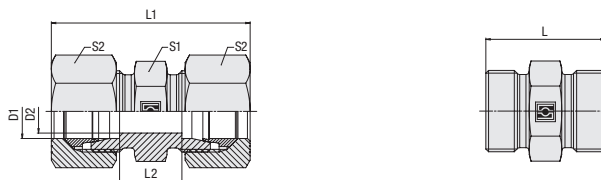

D

**Ordering Codes**

**\*FI-G\*-10\*L\*-W3\*-MS**

- \* Straight Union **FI-G**
- \* Outside Tube Diameter D1 (in mm) **-10**
- \* Series **LL**  
 Extra-Light Series **L**  
 Light Series **S**  
 Heavy Series
- \* Material Code **-W3**  
 Steel, zinc/nickel-plated
- Please contact STAUFF for alternative materials and surface finishings.
- \* Assembling / Kitting **—**  
 Fitting body only
- MS**  
 Fitting body supplied with cutting rings and union nuts
- MSV**  
 Fitting body supplied with soft-sealing cutting rings and union nuts

**Connecting Parts**

-  Cutting Ring  
Type **FI-DS** Page 28
-  Soft-Sealing Cutting Ring  
Type **FI-WDDS** Page 29
-  Support Sleeve  
Type **FI-VH** Page 31
-  STAUFF Form EVO Sealing Ring  
Type **FI-FD** Page 32
-  Union Nut  
Type **FI-M** Page 33
-  37° Flared Tube Fitting Set  
Type **FI-AB** Page 37

<sup>1</sup> Approximate dimension in assembled condition.

<sup>2</sup> Weight excluding cutting rings and union nuts.

<sup>3</sup> Standard scope of delivery: Fitting body only.

Series	Tube OD	PN	Dimensions						Weight ( <sup>kg</sup> / <sub>lbs</sub> ) ca. per 100	Ordering Codes <sup>3</sup>	
	( <sup>mm</sup> / <sub>in</sub> ) D1		( <sup>mm</sup> / <sub>in</sub> ) D2	L	L1 <sup>1</sup>	L2	S1	S2			
LL	4	100	3	20	31	12	9	10	0,53	FI-G-04LL-W3	
	.16	1450	.12	.79	1.22	.47	.35	.39	1.16	FI-G-06LL-W3	
	6	100	4,5	20	32	9	11	12	0,79	FI-G-08LL-W3	
	.24	1450	.18	.79	1.26	.35	.43	.47	1.74	FI-G-10LL-W3	
	8	100	6	23	35	12	12	14	1,05	FI-G-12LL-W3	
	.31	1450	.24	.91	1.38	.47	.47	.55	2.30	FI-G-14LL-W3	
	10	100	8	23	35	12	14	17	1,29	FI-G-16LL-W3	
	.39	1450	.31	.91	1.38	.47	.55	.67	2.83	FI-G-18LL-W3	
	12	100	10	23	35	11	17	19	1,83	FI-G-20LL-W3	
	.47	1450	.39	.91	1.38	.43	.67	.75	4.03	FI-G-22LL-W3	
	L	6	500	4	24	39	10	12	14	1,44	FI-G-06L-W3
		.24	7250	.16	.94	1.54	.39	.47	.55	3.17	FI-G-08L-W3
8		500	6	25	40	11	14	17	1,90	FI-G-10L-W3	
.31		7250	.24	.98	1.57	.43	.55	.67	4.18	FI-G-12L-W3	
10		500	8	27	42	13	17	19	2,60	FI-G-14L-W3	
.39		7250	.31	1.06	1.65	.51	.67	.75	5.72	FI-G-16L-W3	
12		400	10	28	43	14	19	22	2,67	FI-G-18L-W3	
.47		5800	.39	1.10	1.69	.55	.75	.87	5.87	FI-G-20L-W3	
15		400	12	30	46	16	24	27	4,81	FI-G-22L-W3	
.59		5800	.47	1.18	1.81	.63	.94	1.06	10.57	FI-G-24L-W3	
18		400	15	31	48	16	27	32	6,65	FI-G-26L-W3	
.71		5800	.59	1.22	1.89	.63	1.06	1.26	14.63	FI-G-28L-W3	
22		250	19	35	52	20	32	36	8,94	FI-G-30L-W3	
.87		3625	.75	1.38	2.05	.79	1.26	1.42	19.66	FI-G-32L-W3	
28		250	24	36	54	21	41	41	13,90	FI-G-34L-W3	
1.10		3625	.94	1.42	2.13	.83	1.61	1.61	30.57	FI-G-36L-W3	
35		250	30	41	63	20	46	50	21,11	FI-G-38L-W3	
1.38		3625	1.18	1.61	2.48	.79	1.81	1.97	46.43	FI-G-40L-W3	
42		250	36	43	66	21	55	60	29,26	FI-G-42L-W3	
1.65		3625	1.42	1.69	2.60	.83	2.17	2.36	64.38	FI-G-44L-W3	
S	6	800	4	30	45	16	14	17	2,52	FI-G-06S-W3	
	.24	11600	.16	1.18	1.77	.63	.55	.67	5.54	FI-G-08S-W3	
	8	800	5	32	47	18	17	19	3,67	FI-G-10S-W3	
	.31	11600	.20	1.26	1.85	.71	.67	.75	8.08	FI-G-12S-W3	
	10	800	7	32	49	17	19	22	4,23	FI-G-14S-W3	
	.39	11600	.28	1.26	1.93	.67	.75	.87	9.30	FI-G-16S-W3	
	12	630	8	34	51	19	22	24	5,88	FI-G-18S-W3	
	.47	9135	.31	1.34	2.01	.75	.87	.94	12.94	FI-G-20S-W3	
	14	630	10	38	57	22	24	27	7,52	FI-G-22S-W3	
	.55	9135	.39	1.50	2.24	.87	.94	1.06	16.54	FI-G-24S-W3	
	16	630	12	38	57	21	27	30	9,20	FI-G-26S-W3	
	.63	9135	.47	1.50	2.24	.83	1.06	1.18	20.25	FI-G-28S-W3	
	20	420	16	44	66	23	32	36	14,27	FI-G-30S-W3	
	.79	6091	.63	1.73	2.60	.91	1.26	1.42	31.40	FI-G-32S-W3	
	25	420	20	50	74	26	41	46	24,99	FI-G-34S-W3	
	.98	6091	.79	1.97	2.91	1.02	1.61	1.81	54.97	FI-G-36S-W3	
	30	420	25	54	80	27	46	50	33,08	FI-G-38S-W3	
	1.18	6091	.98	2.13	3.15	1.06	1.81	1.97	72.77	FI-G-40S-W3	
38	420	32	61	90	29	55	60	53,80	FI-G-42S-W3		
1.50	6091	1.26	2.40	3.54	1.14	2.17	2.36	118.36	FI-G-44S-W3		





### Straight Reducer Type FI-G ▪ Series LL / L

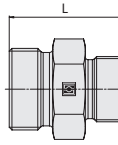
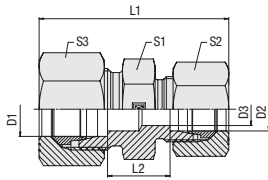

D

Series	Tube OD (mm/in)		PN (bar/psi)	Dimensions (mm/in)							Weight (kg/lbs) ca. per 100	Ordering Codes <sup>3</sup>
	D1	D2		D3	L	L1 <sup>1</sup>	L2	S1	S2	S3		
LL	6	4	100	3	20	32	10,5	11	10	12	0,70	FI-G-06/04LL-W3
	.24	.16	1450	.12	.79	1.26	.41	.43	.39	.47	1.54	
	8	4	100	3	22	34	12,5	12	10	14	1,00	FI-G-08/04LL-W3
	.31	.16	1450	.12	.87	1.34	.49	.47	.39	.55	2.20	
L	8	6	100	4	22	34	11	12	12	14	0,99	FI-G-08/06LL-W3
	.31	.24	1450	.16	.87	1.34	.43	.47	.47	.55	2.18	
	8	6	500	4	25	40	11	14	14	17	1,61	FI-G-08/06L-W3
	.31	.24	7250	.16	.98	1.57	.43	.55	.55	.67	3.54	
10	6	500	4	26	41	12	17	14	19	1,99	FI-G-10/06L-W3	
.39	.24	7250	.16	1.02	1.61	.47	.67	.55	.75	4.37		
10	8	500	6	26	41	12	17	17	19	2,21	FI-G-10/08L-W3	
.39	.31	7250	.24	1.02	1.61	.47	.67	.67	.75	4.86		
12	6	400	4	27	42	13	19	14	22	2,47	FI-G-12/06L-W3	
.47	.24	5800	.16	1.06	1.65	.51	.75	.55	.87	5.43		
12	8	400	6	27	42	13	19	17	22	2,63	FI-G-12/08L-W3	
.47	.31	5800	.24	1.06	1.65	.51	.75	.67	.87	5.78		
12	10	400	8	28	43	14	19	19	22	2,81	FI-G-12/10L-W3	
.47	.39	5800	.31	1.10	1.69	.55	.75	.75	.87	6.19		
15	6	400	4	29	47	15	24	14	27	4,55	FI-G-15/06L-W3	
.59	.24	5800	.16	1.14	1.85	.59	.94	.55	1.06	10.03		
15	8	400	6	29	47	15	24	17	27	4,56	FI-G-15/08L-W3	
.59	.31	5800	.24	1.14	1.85	.59	.94	.67	1.06	10.05		
15	10	400	8	29	45	15	24	19	27	4,36	FI-G-15/10L-W3	
.59	.39	5800	.31	1.14	1.77	.59	.94	.75	1.06	9.59		
15	12	400	10	29	45	15	24	22	27	4,42	FI-G-15/12L-W3	
.59	.47	5800	.39	1.14	1.77	.59	.94	.87	1.06	9.73		
18	8	400	6	30	48	15,5	27	17	32	6,25	FI-G-18/08L-W3	
.71	.31	5800	.24	1.18	1.89	.61	1.06	.67	1.26	13.78		
18	10	400	8	30	46	15,5	27	19	32	6,01	FI-G-18/10L-W3	
.71	.39	5800	.31	1.18	1.81	.61	1.06	.75	1.26	13.22		
18	12	400	10	30	46	15,5	27	22	32	5,56	FI-G-18/12L-W3	
.71	.47	5800	.39	1.18	1.81	.61	1.06	.87	1.26	12.22		
18	15	400	12	31	48	16,5	27	27	32	6,73	FI-G-18/15L-W3	
.71	.59	5800	.47	1.22	1.89	.65	1.06	1.06	1.26	14.81		
22	8	250	6	31	50	16,5	32	17	36	7,56	FI-G-22/08L-W3	
.87	.31	3625	.24	1.22	1.97	.65	1.26	.67	1.42	16.67		
22	10	250	8	32	51	17,5	32	19	36	1,36	FI-G-22/10L-W3	
.87	.39	3625	.31	1.26	2.01	.69	1.26	.75	1.42	3.00		
22	12	250	10	32	48	17,5	32	22	36	7,99	FI-G-22/12L-W3	
.87	.47	3625	.39	1.26	1.89	.69	1.26	.87	1.42	17.57		
22	15	250	12	33	50	18,5	32	27	36	8,37	FI-G-22/15L-W3	
.87	.59	3625	.47	1.30	1.97	.73	1.26	1.06	1.42	18.41		
22	18	250	15	33	50	18	32	32	36	8,76	FI-G-22/18L-W3	
.87	.71	3625	.59	1.30	1.97	.71	1.26	1.26	1.42	19.26		
28	10	250	8	33	53	18,5	41	19	41	12,12	FI-G-28/10L-W3	
1,1	.39	3625	.31	1.3	2.09	.73	1.61	.75	1.61	26.72		
28	12	250	10	33,5	54	19	41	22	41	13,02	FI-G-28/12L-W3	
1,1	.47	3625	.39	1.32	2.13	.75	1.61	.87	1.61	28.70		
28	15	250	12	34	55	19,5	41	27	41	13,12	FI-G-28/15L-W3	
1,1	.59	3625	.47	1.34	2.17	.77	1.61	1.06	1.61	28.92		
28	18	250	15	34	52	19	41	32	41	13,29	FI-G-28/18L-W3	
1.10	.71	3625	.59	1.34	2.05	.75	1.61	1.26	1.61	29.24		
28	22	250	19	36	54	21	41	36	41	13,61	FI-G-28/22L-W3	
1.10	.87	3625	.75	1.42	2.13	.83	1.61	1.42	1.61	29.94		
35	18	250	15	37	60	19	46	32	50	19,74	FI-G-35/18L-W3	
1.38	.71	3625	.59	1.46	2.36	.75	1.81	1.26	1.97	43.52		
35	22	250	19	39	59	21	46	36	50	19,99	FI-G-35/22L-W3	
1.38	.87	3625	.75	1.54	2.32	.83	1.81	1.42	1.97	43.99		
35	28	250	24	39	59	21	46	41	50	19,71	FI-G-35/28L-W3	
1.38	1.10	3625	.94	1.54	2.32	.83	1.81	1.61	1.97	43.35		

### Ordering Codes

**\*FI-G\*-10/\*08\*L\*-W3\*-MS**

- \* Straight Reducer FI-G
  - \* Outside Tube Diameter D1 (in mm) -10
  - \* Outside Tube Diameter D2 (in mm) 08
  - \* Series LL  
     Extra-Light Series (page 97)  
     Light Series (pages 97/98) L  
     Heavy Series (page 98) S
  - \* Material Code -W3  
     Steel, zinc/nickel-plated
- Please contact STAUFF for alternative materials and surface finishings.
- \* Assembling / Kitting —  
     Fitting body only
  - MS  
     Fitting body supplied with cutting rings and union nuts
  - MSV  
     Fitting body supplied with soft-sealing cutting rings and union nuts

### Connecting Parts

-  Cutting Ring  
Type **FI-DS** Page 28
-  Soft-Sealing Cutting Ring  
Type **FI-WDDS** Page 29
-  Support Sleeve  
Type **FI-VH** Page 31
-  STAUFF Form EVO Sealing Ring  
Type **FI-FD** Page 32
-  Union Nut  
Type **FI-M** Page 33
-  37° Flared Tube Fitting Set  
Type **FI-AB** Page 37

<sup>1</sup> Approximate dimension in assembled condition.  
<sup>2</sup> Weight excluding cutting rings and union nuts.  
<sup>3</sup> Standard scope of delivery: Fitting body only.



## Straight Reducer Type FI-G ▪ Series L / S

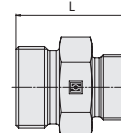
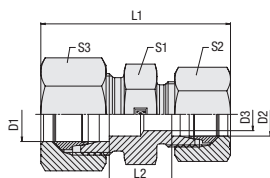

### Ordering Codes

#### \*FI-G\*-10/\*08\*L\*-W3\*-MS

- \* Straight Reducer **FI-G**
- \* Outside Tube Diameter D1 (in mm) **-10**
- \* Outside Tube Diameter D2 (in mm) **08**
- \* Series **LL**  
 Extra-Light Series (page 97)  
**L** Light Series (pages 97/98)  
**S** Heavy Series (page 98)
- \* Material Code **-W3**  
 Steel, zinc/nickel-plated
- Please contact STAUFF for alternative materials and surface finishings.
- \* Assembling / Kitting **—**  
 Fitting body only
- Fitting body supplied with cutting rings and union nuts **-MS**
- Fitting body supplied with soft-sealing cutting rings and union nuts **-MSV**

### Connecting Parts

- Cutting Ring  
Type **FI-DS** Page 28
- Soft-Sealing Cutting Ring  
Type **FI-WDDS** Page 29
- Support Sleeve  
Type **FI-VH** Page 31
- STAUFF Form EVO Sealing Ring  
Type **FI-FD** Page 32
- Union Nut  
Type **FI-M** Page 33
- 37° Flared Tube Fitting Set  
Type **FI-AB** Page 37

<sup>1</sup> Approximate dimension in assembled condition.

<sup>2</sup> Weight excluding cutting rings and union nuts.

<sup>3</sup> Standard scope of delivery: Fitting body only.

Series	Tube OD (mm/in)		PN (bar/psi)	Dimensions (mm/in)						Weight (kg/lbs) ca. per 100	Ordering Codes <sup>3</sup>	
	D1	D2		D3	L	L1 <sup>1</sup>	L2	S1	S2			S3
L	42	18	250	15	37,5	60	19	55	32	60	29,95	FI-G-42/18L-W3
	1,65	.71	3625	.59	1.48	2.36	.75	2.17	1.26	2.36	66.03	
	42	22	250	19	39,5	63	21	55	36	60	22,68	FI-G-42/22L-W3
	1,65	.87	3625	.75	1.56	2.48	.83	2.17	1.42	2.36	55.00	
	42	28	250	24	39,5	66	21	55	41	60	27,03	FI-G-42/28L-W3
	1,65	1.1	3625	.94	1.56	2.6	.83	2.17	1.61	2.36	59.59	
42	35	250	30	42,5	66	21	55	50	60	29,78	FI-G-42/35L-W3	
1,65	1.38	3625	1.18	1.67	2.60	.83	2.17	1.97	2.36	65.52		
S	8	6	800	4	32	47	18	17	17	19	3,46	FI-G-08/06S-W3
	.31	.24	11600	.16	1.26	1.85	.71	.67	.67	.75	7.60	
	10	6	800	4	32	48	17,5	19	17	22	4,40	FI-G-10/06S-W3
	.39	.24	11600	.16	1.26	1.89	.69	.75	.67	.87	9.68	
	10	8	800	5	32	48	17,5	19	19	22	4,26	FI-G-10/08S-W3
	.39	.31	11600	.20	1.26	1.89	.69	.75	.75	.87	9.37	
	12	6	630	4	34	50	19,5	22	17	24	5,56	FI-G-12/06S-W3
	.47	.24	9135	.16	1.34	1.97	.77	.87	.67	.94	12.24	
	12	8	630	5	34	50	19,5	22	19	24	4,03	FI-G-12/08S-W3
	.47	.31	9135	.20	1.34	1.97	.77	.87	.75	.94	8.87	
	12	10	630	7	34	51	19	22	22	24	5,86	FI-G-12/10S-W3
	.47	.39	9135	.28	1.34	2.01	.75	.87	.87	.94	12.90	
	14	10	630	7	36	54	20,5	24	22	27	7,16	FI-G-14/10S-W3
	.55	.39	9135	.28	1.42	2.13	.81	.94	.87	1.06	15.76	
	14	12	630	8	36	54	20,5	24	24	27	7,34	FI-G-14/12S-W3
	.55	.47	9135	.31	1.42	2.13	.81	.94	.94	1.06	16.15	
	16	6	630	35,5	35,5	55	20	27	17	30	7,78	FI-G-16/06S-W3
	.63	.24	9135	1.4	1.4	2.17	.79	1.06	.67	1.18	17.15	
	16	8	630	5	35,5	55	20	27	19	30	7,86	FI-G-16/08S-W3
	.63	.31	9135	.2	1.4	2.17	.79	1.06	.75	1.18	17.33	
	16	10	630	7	36	54	20	27	22	30	7,95	FI-G-16/10S-W3
	.63	.39	9135	.28	1.42	2.13	.79	1.06	.87	1.18	17.49	
	16	12	630	8	36	54	20	27	24	30	9,32	FI-G-16/12S-W3
	.63	.47	9135	.31	1.42	2.13	.79	1.06	.94	1.18	20.50	
	16	14	630	10	38	57	21,5	27	27	30	8,95	FI-G-16/14S-W3
	.63	.55	9135	.39	1.50	2.24	.85	1.06	1.06	1.18	19.69	
	20	10	420	7	40	60	22	32	22	36	12,93	FI-G-20/10S-W3
	.79	.39	6091	.28	1.57	2.36	.87	1.26	.87	1.42	28.44	
	20	12	420	8	40	60	22	32	24	36	13,19	FI-G-20/12S-W3
	.79	.47	6091	.31	1.57	2.36	.87	1.26	.94	1.42	29.02	
	20	16	420	12	42	63	23	32	30	36	13,38	FI-G-20/16S-W3
	.79	.63	6091	.47	1.65	2.48	.91	1.26	1.18	1.42	29.44	
	25	12	420	8	45	68	25,5	41	24	46	23,92	FI-G-25/12S-W3
	.98	.47	6091	.31	1.77	2.68	1.00	1.61	.94	1.81	52.73	
	25	16	420	12	46	68	25,5	41	30	46	22,87	FI-G-25/16S-W3
	.98	.63	6091	.47	1.81	2.68	1.00	1.61	1.18	1.81	50.31	
25	20	420	16	48	71	25,5	41	36	46	23,66	FI-G-25/20S-W3	
.98	.79	6091	.63	1.89	2.80	1.00	1.61	1.42	1.81	52.05		
30	12	420	8	46	71	25	46	24	50	29,2	FI-G-30/12S-W3	
1,18	.47	6091	.31	1.81	2.8	.95	1.81	.94	1.97	64.37		
30	16	420	12	48	74	26	46	30	50	29,61	FI-G-30/16S-W3	
1,18	.63	6091	.47	1.89	2.91	1.02	1.81	1.18	1.97	65.28		
30	20	420	16	50	74	26	46	36	50	30,33	FI-G-30/20S-W3	
1,18	.79	6091	.63	1.97	2.91	1.02	1.81	1.42	1.97	66.73		
30	25	420	20	52	77	26,5	46	46	50	31,79	FI-G-30/25S-W3	
1,18	.98	6091	.79	2.05	3.03	1.04	1.81	1.81	1.97	69.95		
38	16	420	12	53	80	28,5	55	30	60	46,99	FI-G-38/16S-W3	
1,5	.63	6091	.47	2.09	3.15	1.12	2.17	1.18	2.36	103.60		
38	20	420	16	55	84	28,5	55	36	60	49,57	FI-G-38/20S-W3	
1,5	.79	6091	.63	2.17	3.31	1.12	2.17	1.42	2.36	109.28		
38	25	420	20	57	87	29	55	46	60	51,3	FI-G-38/25S-W3	
1,5	.98	6091	.79	2.24	3.43	1.14	2.17	1.81	2.36	113.10		
38	30	420	25	59	87	29,5	55	50	60	50,90	FI-G-38/30S-W3	
1,50	1.18	6091	.98	2.32	3.43	1.16	2.17	1.97	2.36	111.98		



Equal Elbow  
Type FI-W ▪ Series LL / L / S

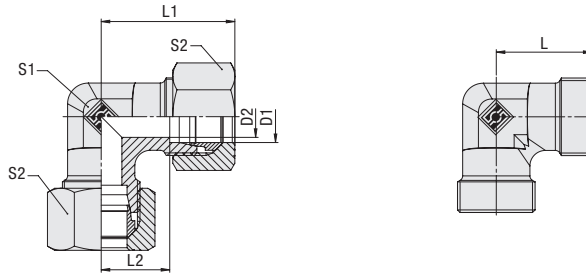

Series	Tube OD		PN (bar/PSI)	Dimensions (mm/in)					Weight (%/lbs) ca. per 100	Ordering Codes <sup>3</sup>	
	D1	D2		L	L1 <sup>1</sup>	L2	S1	S2			
LL	4	100	3	15	21	11	9	10	1,29	FI-W-04LL-W3-PR	
	.16	1450	.12	.59	.83	.43	.35	.39	2.83		
	6	100	4,5	15	21	9,5	11	12	1,57	FI-W-06LL-W3-PR	
	.24	1450	.18	.59	.83	.37	.43	.47	3.45		
	8	100	6	17	23	11,5	12	14	2,22	FI-W-08LL-W3-PR	
	.31	1450	.24	.67	.91	.45	.47	.55	4.88		
	10	100	8	18	23	12,5	12	17	2,70	FI-W-10LL-W3-PR	
	.39	1450	.31	.71	.91	.49	.47	.67	5.95		
	12	100	10	21	27	15	14	19	2,20	FI-W-12LL-W3-PR	
	.47	1450	.39	.83	1.06	.59	.55	.75	4.85		
	L	6	500	4	19	27	12	12	14	1,94	FI-W-06L-W3
		.24	7250	.16	.75	1.06	.47	.47	.55	4.27	
8		500	6	21	29	14	12	17	2,35	FI-W-08L-W3	
.31		7250	.24	.83	1.14	.55	.47	.67	5.17		
10		500	8	22	30	15	14	19	3,06	FI-W-10L-W3	
.39		7250	.31	.87	1.18	.59	.55	.75	6.72		
12		400	10	24	32	17	17	22	4,34	FI-W-12L-W3	
.47		5800	.39	.94	1.26	.67	.67	.87	9.55		
15		400	12	28	36	21	19	27	5,13	FI-W-15L-W3	
.59		5800	.47	1.10	1.42	.83	.75	1.06	11.29		
18		400	15	31	40	23,5	24	32	11,63	FI-W-18L-W3	
.71		5800	.59	1.22	1.57	.93	.94	1.26	25.59		
22		250	19	35	44	27,5	27	36	15,35	FI-W-22L-W3	
.87		3625	.75	1.38	1.73	1.08	1.06	1.42	33.77		
28		250	24	38	47	30,5	36	41	25,45	FI-W-28L-W3	
1.10		3625	.94	1.50	1.85	1.20	1.42	1.61	56.00		
35		250	30	45	56	34,5	41	50	42,04	FI-W-35L-W3	
1.38		3625	1.18	1.77	2.20	1.36	1.61	1.97	92.48		
42		250	36	51	63	40	50	60	63,20	FI-W-42L-W3	
1.65		3625	1.42	2.01	2.48	1.57	1.97	2.36	139.04		
S	6	800	4	23	31	16	12	17	3,32	FI-W-06S-W3	
	.24	11600	.16	.91	1.22	.63	.47	.67	7.30		
	8	800	5	24	32	17	14	19	4,68	FI-W-08S-W3	
	.31	11600	.20	.94	1.26	.67	.55	.75	10.30		
	10	800	7	25	34	17,5	17	22	6,02	FI-W-10S-W3	
	.39	11600	.28	.98	1.34	.69	.67	.87	13.24		
	12	630	8	29	38	21,5	17	24	8,14	FI-W-12S-W3	
	.47	9135	.31	1.14	1.50	.85	.67	.94	17.91		
	14	630	10	30	40	22	19	27	9,86	FI-W-14S-W3	
	.55	9135	.39	1.18	1.57	.87	.75	1.06	21.69		
	16	630	12	33	43	24,5	24	30	14,13	FI-W-16S-W3	
	.63	9135	.47	1.30	1.69	.96	.94	1.18	31.09		
	20	420	16	37	48	26,5	27	36	20,50	FI-W-20S-W3	
	.79	6091	.63	1.46	1.89	1.04	1.06	1.42	45.10		
	25	420	20	42	54	30	36	46	36,09	FI-W-25S-W3	
	.98	6091	.79	1.65	2.13	1.18	1.42	1.81	79.40		
	30	420	25	49	62	35,5	41	50	40,20	FI-W-30S-W3	
	1.18	6091	.98	1.93	2.44	1.40	1.61	1.97	102.11		
38	420	32	57	72	41	50	60	89,05	FI-W-38S-W3		
1.50	6091	1.26	2.24	2.83	1.61	1.97	2.36	196.90			

Ordering Codes

\*FI-W\*-10\*L\*-W3\*-MS

* Equal Elbow		FI-W
* Outside Tube Diameter D1 (in mm)		-10
* Series	Extra-Light Series	LL
	Light Series	L
	Heavy Series	S
* Material Code	Steel, zinc/nickel-plated	-W3
Please contact STAUFF for alternative materials and surface finishings.		
* Design	Made from forging blanks	—
	Made from profile material	PR
* Assembling / Kitting	Fitting body only	—
	Fitting body supplied with cutting rings and union nuts	-MS
	Fitting body supplied with soft-sealing cutting rings and union nuts	-MSV

Connecting Parts

	Cutting Ring Type FI-DS	Page 28
	Soft-Sealing Cutting Ring Type FI-WDDS	Page 29
	Support Sleeve Type FI-VH	Page 31
	STAUFF Form EVO Sealing Ring Type FI-FD	Page 32
	Union Nut Type FI-M	Page 33
	37° Flared Tube Fitting Set Type FI-AB	Page 37

<sup>1</sup> Approximate dimension in assembled condition.

<sup>2</sup> Weight excluding cutting rings and union nuts.

<sup>3</sup> Standard scope of delivery: Fitting body only.



**Equal Tee**  
Type FI-T ▪ Series LL / L / S

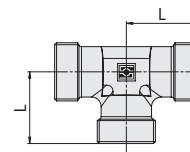
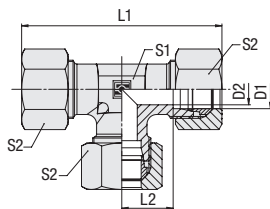

D

**Ordering Codes**

**\*FI-T\*-10\*L\*-W3\*-MS**

- \* Equal Tee **FI-T**
- \* Outside Tube Diameter D1 (in mm) **-10**
- \* Series **LL**  
     Extra-Light Series **L**  
     Light Series **S**  
     Heavy Series
- \* Material Code **-W3**  
     Steel, zinc/nickel-plated
- Please contact STAUFF for alternative materials and surface finishings.
- \* Assembling / Kitting **—**  
     Fitting body only
- MS**  
     Fitting body supplied with cutting rings and union nuts
- MSV**  
     Fitting body supplied with soft-sealing cutting rings and union nuts

**Connecting Parts**

- Cutting Ring  
Type **FI-DS** Page 28
- Soft-Sealing Cutting Ring  
Type **FI-WDDS** Page 29
- Support Sleeve  
Type **FI-VH** Page 31
- STAUFF Form EVO Sealing Ring  
Type **FI-FD** Page 32
- Union Nut  
Type **FI-M** Page 33
- 37° Flared Tube Fitting Set  
Type **FI-AB** Page 37

Series	Tube OD	PN	Dimensions					Weight	Ordering Codes <sup>3</sup>		
	(mm/in) D1		(bar/psi) D2	(mm/in) L	(mm/in) L1 <sup>1</sup>	L2	S1			S2	(kg/lbs) ca. per 100
LL	4	100	3	15	42	11	9	10	1,00	FI-T-04LL-W3	
	.16	1450	.12	.59	1.65	.43	.35	.39	2.20	FI-T-06LL-W3	
	6	100	4,5	15	42	9,5	9	12	1,23	FI-T-08LL-W3	
	.24	1450	.18	.59	1.65	.37	.35	.47	2.70	FI-T-10LL-W3	
	8	100	6	17	46	11,5	12	14	1,91	FI-T-12LL-W3	
	.31	1450	.24	.67	1.81	.45	.47	.55	4.19	FI-T-14LL-W3	
	10	100	8	21,5	54	16	14	17	3,42	FI-T-16LL-W3	
	.39	1450	.31	.85	2.13	.63	.55	.67	7.54	FI-T-18LL-W3	
	12	100	10	21,5	59	15	14	19	3,80	FI-T-20LL-W3	
	.47	1450	.39	.85	2.32	.59	.55	.75	8.38	FI-T-22LL-W3	
	L	6	500	4	19	54	12	12	14	2,66	FI-T-06L-W3
		.24	7250	.16	.75	2.13	.47	.47	.55	5.86	FI-T-08L-W3
8		500	6	21	58	14	12	17	3,17	FI-T-10L-W3	
.31		7250	.24	.83	2.28	.55	.47	.67	6.97	FI-T-12L-W3	
10		500	8	22	60	15	14	19	4,06	FI-T-14L-W3	
.39		7250	.31	.87	2.36	.59	.55	.75	8.93	FI-T-16L-W3	
12		400	10	24	64	17	17	22	5,52	FI-T-18L-W3	
.47		5800	.39	.94	2.52	.67	.67	.87	12.15	FI-T-20L-W3	
15		400	12	28	72	21	19	27	9,98	FI-T-22L-W3	
.59		5800	.47	1.10	2.83	.83	.75	1.06	21.95	FI-T-24L-W3	
18		400	15	31	80	23,5	24	32	14,83	FI-T-26L-W3	
.71		5800	.59	1.22	3.15	.93	.94	1.26	32.63	FI-T-28L-W3	
22		250	19	35	88	27,5	27	36	18,81	FI-T-30L-W3	
.87		3625	.75	1.38	3.46	1.08	1.06	1.42	41.39	FI-T-32L-W3	
28		250	24	38	94	30,5	36	41	30,44	FI-T-34L-W3	
1.10		3625	.94	1.50	3.70	1.20	1.42	1.61	66.97	FI-T-36L-W3	
35		250	30	45	112	34,5	41	50	49,27	FI-T-38L-W3	
1.38		3625	1.18	1.77	4.41	1.36	1.61	1.97	108.39	FI-T-40L-W3	
42	250	36	51	126	40	50	60	72,20	FI-T-42L-W3		
1.65	3625	1.42	2.01	4.96	1.57	1.97	2.36	158.84	FI-T-44L-W3		
S	6	800	4	23	62	16	12	17	4,60	FI-T-06S-W3	
	.24	11600	.16	.91	2.44	.63	.47	.67	10.12	FI-T-08S-W3	
	8	800	5	24	64	17	14	19	6,21	FI-T-10S-W3	
	.31	11600	.20	.94	2.52	.67	.55	.75	13.65	FI-T-12S-W3	
	10	800	7	25	68	17,5	17	22	7,92	FI-T-14S-W3	
	.39	11600	.28	.98	2.68	.69	.67	.87	17.42	FI-T-16S-W3	
	12	630	8	29	76	21,5	17	24	10,88	FI-T-18S-W3	
	.47	9135	.31	1.14	2.99	.85	.67	.94	23.93	FI-T-20S-W3	
	14	630	10	30	80	22	19	27	12,97	FI-T-22S-W3	
	.55	9135	.39	1.18	3.15	.87	.75	1.06	28.53	FI-T-24S-W3	
	16	630	12	33	86	24,5	24	30	10,97	FI-T-26S-W3	
	.63	9135	.47	1.30	3.39	.96	.94	1.18	24.14	FI-T-28S-W3	
	20	420	16	37	96	26,5	27	36	25,58	FI-T-30S-W3	
	.79	6091	.63	1.46	3.78	1.04	1.06	1.42	56.28	FI-T-32S-W3	
	25	420	20	42	108	30	36	46	44,75	FI-T-34S-W3	
	.98	6091	.79	1.65	4.25	1.18	1.42	1.81	98.46	FI-T-36S-W3	
	30	420	25	49	124	35,5	41	50	68,20	FI-T-38S-W3	
	1.18	6091	.98	1.93	4.88	1.40	1.61	1.97	150.04	FI-T-40S-W3	
38	420	32	57	144	41	50	60	108,00	FI-T-42S-W3		
1.50	6091	1.26	2.24	5.67	1.61	1.97	2.36	237.60	FI-T-44S-W3		

<sup>1</sup> Approximate dimension in assembled condition.

<sup>2</sup> Weight excluding cutting rings and union nuts.

<sup>3</sup> Standard scope of delivery: Fitting body only.



**Tee Reducer**  
**Type FI-T • Series L**

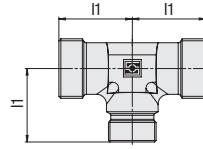
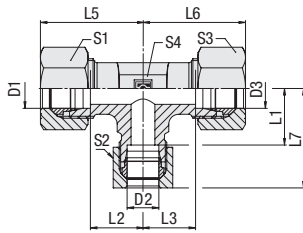

Sequence of connections  
in the ordering codes for  
tee reducers:



Series	Tube OD (mm/in)			PN (bar/psi)	Dimensions (mm/in)										Weight ( <sup>kg</sup> /lbs) ca. per 100	Ordering Codes <sup>3</sup>	
	D1	D2	D3		L1	L2	L3	L5 <sup>1</sup>	L6 <sup>1</sup>	L7 <sup>1</sup>	S1	S2	S3	S4			
L	6	8	6	500	21	14	14	14	29	29	29	17	14	12	12	3,81	FI-T-06/08/06L-W3
	.24	.31	.24	7250	.83	.55	.55	.55	1.14	1.14	1.14	.67	.55	.47	.47	8.38	
L	6	10	6	500	22	15	15	15	30	30	30	19	14	14	14	4,90	FI-T-06/10/06L-W3
	.24	.39	.24	7250	.87	.59	.59	.59	1.18	1.18	1.18	.75	.55	.55	.55	10.78	
L	8	6	8	500	21	14	14	14	29	29	29	14	17	12	12	3,27	FI-T-08/06/08L-W3
	.31	.24	.31	7250	.83	.55	.55	.55	1.14	1.14	1.14	.55	.67	.47	.47	7.20	
L	8	10	8	500	22	15	15	15	30	30	30	19	17	14	14	4,35	FI-T-08/10/08L-W3
	.31	.39	.31	7250	.87	.59	.59	.59	1.18	1.18	1.18	.75	.67	.55	.55	9.57	
L	8	12	8	400	24	17	17	17	32	32	32	22	17	17	17	5,94	FI-T-08/12/08L-W3
	.31	.47	.31	5800	.94	.67	.67	.67	1.26	1.26	1.26	.87	.67	.67	.67	13.06	
L	10	6	10	500	22	15	15	15	30	30	30	14	19	14	14	4,18	FI-T-10/06/10L-W3
	.39	.24	.39	7250	.87	.59	.59	.59	1.18	1.18	1.18	.55	.75	.55	.55	9.19	
L	10	8	10	500	22	15	15	15	30	30	30	17	19	14	14	4,11	FI-T-10/08/10L-W3
	.39	.31	.39	7250	.87	.59	.59	.59	1.18	1.18	1.18	.67	.75	.55	.55	9.05	
L	10	10	6	500	21	15	15	14	31	29	30	19	19	14	14	4,13	FI-T-10/10/06L-W3
	.39	.39	.24	7250	.83	.59	.59	.55	1.22	1.14	1.18	.75	.75	.55	.55	9.11	
L	10	12	10	400	24	17	17	17	31	31	32	19	22	19	17	5,81	FI-T-10/12/10L-W3
	.39	.47	.39	5800	.94	.67	.67	.67	1.22	1.22	1.26	.75	.87	.75	.67	12.81	
L	10	15	10	400	28	21	21	21	36	36	36	27	19	19	19	10,05	FI-T-10/15/10L-W3
	.39	.59	.39	5800	1.10	.83	.83	.83	1.42	1.42	1.42	1.06	.75	.75	.75	22.10	
L	12	6	12	400	24	17	17	17	32	32	32	14	22	17	17	5,66	FI-T-12/06/12L-W3
	.47	.24	.47	5800	.94	.67	.67	.67	1.26	1.26	1.26	.55	.87	.67	.67	12.44	
L	12	8	8	400	24	17	17	17	32	32	32	22	17	17	17	5,69	FI-T-12/08/08L-W3
	.47	.31	.31	5800	.94	.67	.67	.67	1.26	1.26	1.26	.87	.67	.67	.67	12.54	
L	12	8	12	400	24	17	17	17	32	32	32	17	22	17	17	5,68	FI-T-12/08/12L-W3
	.47	.31	.47	5800	.94	.67	.67	.67	1.26	1.26	1.26	.67	.87	.67	.67	12.50	
L	12	10	10	400	24	17	17	17	32	32	32	22	19	19	17	6,62	FI-T-12/10/10L-W3
	.47	.39	.39	5800	.94	.67	.67	.67	1.26	1.26	1.26	.87	.75	.75	.67	14.59	
L	12	10	12	400	24	17	17	17	32	32	32	19	22	17	17	5,58	FI-T-12/10/12L-W3
	.47	.39	.47	5800	.94	.67	.67	.67	1.26	1.26	1.26	.75	.87	.67	.67	12.28	
L	12	12	8	400	24	17	17	17	33	31	32	22	22	17	17	5,65	FI-T-12/12/08L-W3
	.47	.47	.31	5800	.94	.67	.67	.67	1.30	1.22	1.26	.87	.87	.67	.67	12.46	
L	12	15	12	400	28	21	21	21	36	36	36	27	22	19	19	9,73	FI-T-12/15/12L-W3
	.47	.59	.47	5800	1.10	.83	.83	.83	1.42	1.42	1.42	1.06	.87	.75	.75	21.41	
L	12	18	12	400	31	24	23,5	24	40	39	39	32	22	24	24	14,87	FI-T-12/18/12L-W3
	.47	.71	.47	5800	1.22	.94	.93	.94	1.57	1.54	1.54	1.26	.87	.94	.94	32.72	
L	15	6	15	400	28	21	21	21	36	36	36	14	27	19	19	10,06	FI-T-15/06/15L-W3
	.59	.24	.59	5800	1.10	.83	.83	.83	1.42	1.42	1.42	.55	1.06	.75	.75	22.14	
L	15	8	15	400	28	21	21	21	36	36	35	27	17	27	19	8,92	FI-T-15/08/15L-W3
	.59	.31	.59	5800	1.10	.83	.83	.83	1.42	1.42	1.38	1.06	.67	1.06	.75	19.66	
L	15	10	15	400	28	21	21	21	36	36	36	19	27	19	19	9,82	FI-T-15/10/15L-W3
	.59	.39	.59	5800	1.10	.83	.83	.83	1.42	1.42	1.42	.75	1.06	.75	.75	21.61	
L	15	12	12	400	28	21	21	21	37	36	36	27	22	22	19	9,41	FI-T-15/12/12L-W3
	.59	.47	.47	5800	1.10	.83	.83	.83	1.46	1.42	1.42	1.06	.87	.87	.75	20.75	
L	15	12	15	400	28	21	21	21	36	36	36	22	27	19	19	9,70	FI-T-15/12/15L-W3
	.59	.47	.59	5800	1.10	.83	.83	.83	1.42	1.42	1.42	.87	1.06	.75	.75	21.35	
L	15	15	12	400	28	21	21	21	36	36	36	27	27	22	19	2,10	FI-T-15/15/12L-W3
	.59	.59	.47	5800	1.10	.83	.83	.83	1.42	1.42	1.42	1.06	1.06	.87	.75	4.63	
L	15	18	15	400	31	24	23,5	24	40	39	39	32	27	24	24	15,22	FI-T-15/18/15L-W3
	.59	.71	.59	5800	1.22	.94	.93	.94	1.57	1.54	1.54	1.26	1.06	.94	.94	33.48	

<sup>1</sup> Approximate dimension in assembled condition.

<sup>2</sup> Weight excluding cutting rings and union nuts.

<sup>3</sup> Standard scope of delivery: Fitting body only.

**Ordering Codes**

**\*FI-T\*-10/\*08/\*10\*L\*-W3\*-MS**

- \* Tee Reducer FI-T
- \* Outside Tube Diameter D1 (in mm) -10
- \* Outside Tube Diameter D2 (in mm) 08
- \* Outside Tube Diameter D3 (in mm) 10
- \* Series L  
Light Series (page 101/102)
- Heavy Series (page 103) S
- \* Material Code -W3  
Steel, zinc/nickel-plated
- Please contact STAUFF for alternative materials and surface finishings.
- \* Assembling / Kitting —  
Fitting body only
- Fitting body supplied with cutting rings and union nuts -MS
- Fitting body supplied with soft-sealing cutting rings and union nuts -MSV

**Connecting Parts**

- Cutting Ring  
Type **FI-DS** Page 28
- Soft-Sealing Cutting Ring  
Type **FI-WDDS** Page 29
- Support Sleeve  
Type **FI-VH** Page 31
- STAUFF Form EVO Sealing Ring  
Type **FI-FD** Page 32
- Union Nut  
Type **FI-M** Page 33
- 37° Flared Tube Fitting Set  
Type **FI-AB** Page 37



### Tee Reducer Type FI-T ▪ Series L

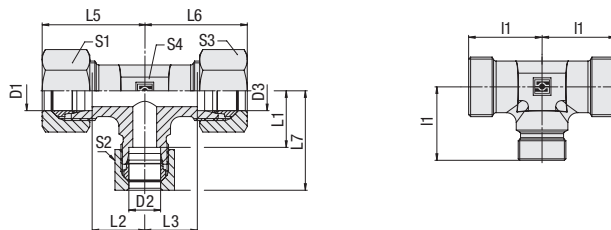

Sequence of connections  
in the ordering codes for  
tee reducers:



#### Ordering Codes

**\*FI-T\*-10/\*08/\*10\*L\*-W3\*-MS**

- \* Tee Reducer FI-T
- \* Outside Tube Diameter D1 (in mm) -10
- \* Outside Tube Diameter D2 (in mm) 08
- \* Outside Tube Diameter D3 (in mm) 10
- \* Series L  
Light Series (page 101/102)  
Heavy Series (page 103) S
- \* Material Code -W3  
Steel, zinc/nickel-plated
- Please contact STAUFF for alternative materials and surface finishings.
- \* Assembling / Kitting —  
Fitting body only
- Fitting body supplied with cutting rings and union nuts -MS
- Fitting body supplied with soft-sealing cutting rings and union nuts -MSV

#### Connecting Parts

- Cutting Ring  
Type **FI-DS** Page 28
- Soft-Sealing Cutting Ring  
Type **FI-WDDS** Page 29
- Support Sleeve  
Type **FI-VH** Page 31
- STAUFF Form EVO Sealing Ring  
Type **FI-FD** Page 32
- Union Nut  
Type **FI-M** Page 33
- 37° Flared Tube Fitting Set  
Type **FI-AB** Page 37

<sup>1</sup> Approximate dimension in assembled condition.

<sup>2</sup> Weight excluding cutting rings and union nuts.

<sup>3</sup> Standard scope of delivery: Fitting body only.

Series	Tube OD		PN	Dimensions										Weight (*90/ks) ca. per 100	Ordering Codes <sup>3</sup>		
	(mm/in)	(mm/in)		(bar/psi)	(mm/in)	(mm/in)	(mm/in)	(mm/in)	(mm/in)	(mm/in)	(mm/in)	(mm/in)	(mm/in)			(mm/in)	(mm/in)
L	D1	D2	D3	I1	L1	L2	L3	L5 <sup>1</sup>	L6 <sup>1</sup>	L7 <sup>1</sup>	S1	S2	S3	S4			
	18	8	18	400	31	23,5	24	23,5	40	40	39	32	17	32	24	14,80	FI-T-18/08/18L-W3
	.71	.31	.39	5800	1.22	.93	.94	.93	1.57	1.57	1.54	1.26	.67	1.26	.94	32.63	FI-T-18/10/10L-W3
	18	10	10	400	31	24	23,5	24	40	39	39	32	19	19	24	14,88	FI-T-18/10/18L-W3
	.71	.39	.39	5800	1.22	.94	.93	.94	1.57	1.54	1.54	1.26	.75	.75	.94	32.80	FI-T-18/10/12L-W3
	18	10	18	400	31	24	23,5	23,5	39	40	40	19	32	24	24	14,52	FI-T-18/12/18L-W3
	.71	.39	.71	5800	1.22	.94	.93	.93	1.54	1.57	1.57	.75	1.26	.94	.94	31.95	FI-T-18/12/22L-W3
	18	12	12	400	31	24	23,5	24	40	39	40	32	22	22	24	14,43	FI-T-18/12/18L-W3
	.71	.47	.47	5800	1.22	.94	.93	.94	1.57	1.54	1.57	1.26	.87	.87	.94	31.81	FI-T-18/12/18L-W3
	18	12	18	400	31	24	23,5	23,5	39	40	40	22	32	24	24	14,76	FI-T-18/15/15L-W3
	.71	.47	.71	5800	1.22	.94	.93	.93	1.54	1.57	1.57	.87	1.26	.94	.94	32.48	FI-T-18/15/18L-W3
	18	15	15	400	31	24	23,5	24	40	40	40	32	27	27	24	14,36	FI-T-18/15/18L-W3
	.71	.59	.59	5800	1.22	.94	.93	.94	1.57	1.57	1.57	1.26	1.06	1.06	.94	31.66	FI-T-18/15/18L-W3
	18	15	18	400	31	24	23,5	23,5	39	40	40	27	32	24	24	14,62	FI-T-18/15/18L-W3
	.71	.59	.71	5800	1.22	.94	.93	.93	1.54	1.57	1.57	1.06	1.26	.94	.94	32.16	FI-T-18/18/10L-W3
	18	18	10	400	31	23,5	23,5	24	40	39	40	32	32	19	24	14,31	FI-T-18/18/12L-W3
	.71	.71	.39	5800	1.22	.93	.93	.94	1.57	1.54	1.57	1.26	1.26	.75	.94	31.55	FI-T-18/18/12L-W3
	18	18	12	400	31	23,5	23,5	24	40	39	40	32	32	22	24	14,53	FI-T-18/18/12L-W3
	.71	.71	.47	5800	1.22	.93	.93	.94	1.57	1.54	1.57	1.26	1.26	.87	.94	32.03	FI-T-18/22/18L-W3
	18	22	18	250	35	27,5	27,5	27,5	43,5	43,5	41	32	36	32	27	21,60	FI-T-22/10/22L-W3
	.71	.87	.71	3625	1.38	1.08	1.08	1.08	1.71	1.71	1.61	1.26	1.42	1.26	1.06	47.62	FI-T-22/10/22L-W3
	22	10	22	250	35	28	27,5	27,5	43	44	44	19	36	27	27	19,89	FI-T-22/12/22L-W3
	.87	.39	.87	3625	1.38	1.10	1.08	1.08	1.69	1.73	1.73	.75	1.42	1.06	1.06	43.75	FI-T-22/12/22L-W3
	22	12	22	250	35	28	27,5	27,5	43	44	44	22	36	27	27	20,30	FI-T-22/15/15L-W3
	.87	.47	.87	3625	1.38	1.10	1.08	1.08	1.69	1.73	1.73	.87	1.42	1.06	1.06	44.66	FI-T-22/15/15L-W3
	22	15	15	250	35	28	27,5	28	44,5	42,5	43	36	27	27	27	21,11	FI-T-22/15/22L-W3
	.87	.59	.59	3625	1.38	1.10	1.08	1.10	1.75	1.67	1.69	1.42	1.06	1.06	1.06	46.54	FI-T-22/15/22L-W3
	22	15	22	250	35	28	27,5	27,5	43	44	44	27	36	27	27	20,19	FI-T-22/18/18L-W3
	0,87	.59	.87	3625	1.38	1.10	1.08	1.08	1.69	1.73	1.73	1.06	1.42	1.06	1.06	44.43	FI-T-22/18/18L-W3
	22	18	18	250	35	27,5	27,5	27,5	44,5	43,5	44	36	32	32	27	20,66	FI-T-22/18/22L-W3
	.87	.71	.71	3625	1.38	1.08	1.08	1.08	1.75	1.71	1.73	1.42	1.26	1.26	1.06	45.55	FI-T-22/18/22L-W3
	22	18	22	250	35	27,5	27,5	27,5	44	44	44	32	36	27	27	20,29	FI-T-22/28/22L-W3
	.87	.71	.87	3625	1.38	1.08	1.08	1.08	1.73	1.73	1.73	1.26	1.42	1.06	1.06	44.64	FI-T-22/28/22L-W3
	22	28	22	250	38	30,5	30,5	30,5	47,5	47,5	48	36	41	36	36	33,66	FI-T-28/10/28L-W3
	.87	1.10	.87	3625	1.50	1.20	1.20	1.20	1.87	1.87	1.89	1.42	1.61	1.42	1.42	74.21	FI-T-28/10/28L-W3
	28	10	28	250	38	30,5	31	30,5	46	47	47	19	41	36	36	32,82	FI-T-28/12/28L-W3
	1.10	.39	1.10	3625	1.50	1.20	1.22	1.20	1.81	1.85	1.85	.75	1.61	1.42	1.42	72.20	FI-T-28/12/28L-W3
	28	12	28	250	38	30,5	31	30,5	46	47	47	22	41	36	36	34,10	FI-T-28/15/28L-W3
	1.10	.47	1.10	3625	1.50	1.20	1.22	1.20	1.81	1.85	1.85	.87	1.61	1.42	1.42	75.02	FI-T-28/15/28L-W3
	28	15	28	250	38	31	30,5	30,5	46	47	47	27	41	36	36	22,97	FI-T-28/18/18L-W3
	1.10	.59	1.10	3625	1.50	1.22	1.20	1.20	1.81	1.85	1.85	1.06	1.61	1.42	1.42	50.54	FI-T-28/18/18L-W3
	28	18	18	250	38	30,5	30,5	30,5	47,5	46,5	47	41	32	32	36	36,07	FI-T-28/18/28L-W3
	1.10	.71	.71	3625	1.50	1.20	1.20	1.20	1.87	1.83	1.85	1.61	1.26	1.26	1.42	79.52	FI-T-28/18/28L-W3
	28	18	28	250	38	30,5	30,5	30,5	47	47	47	32	41	36	36	18,70	FI-T-28/22/22L-W3
	1.10	.71	1.10	3625	1.50	1.20	1.20	1.20	1.85	1.85	1.85	1.26	1.61	1.42	1.42	41.14	FI-T-28/22/22L-W3
	28	22	22	250	38	30,5	30,5	30,5	47,5	46,5	47	41	36	36	36	31,88	FI-T-28/22/22L-W3
	1.10	.87	.87	3625	1.50	1.20	1.20	1.20	1.87	1.83	1.85	1.61	1.42	1.42	1.42	70.28	FI-T-28/22/28L-W3
	28	22	28	250	38	30,5	30,5	30,5	47	47	47	36	41	36	36	31,70	FI-T-28/22/28L-W3
	1.10	.87	1.10	3625	1.50	1.20	1.20	1.20	1.85	1.85	1.85	1.42	1.61	1.42	1.42	69.74	FI-T-35/18/35L-W3
	35	18	35	250	45	34,5	37,5	34,5	54	56	56	32	50	41	41	59,68	FI-T-35/22/35L-W3
	1.38	.71	1.38	3625	1.77	1.36	1.48	1.36	2.13	2.20	2.20	1.26	1.97	1.61	1.61	131.30	FI-T-35/22/35L-W3
	35	22	35	250	45	34,5	37,5	34,5	54	56	56	36	50	41	41	55,00	FI-T-35/28/35L-W3
	1.38	.87	1.38	3625	1.77	1.36	1.48	1.36	2.13	2.20	2.20	1.42	1.97	1.61	1.61	121.00	FI-T-35/28/35L-W3
	35	28	35	250	45	34,5	37,5	34,5	54	56	56	41	50	41	41	49,74	FI-T-42/22/42L-W3
	1.38	1.10	1.38	3625	1.77	1.36	1.48	1.36	2.13	2.20	2.20	1.61	1.97	1.61	1.61	109.43	FI-T-42/22/42L-W3
	42	22	42	250	51	40	43,5	40	60	63	63	36	60	50	50	79,20	FI-T-42/28/42L-W3
	1.65	.87	1.65	3625	2.01	1.57	1.71	1.57	2.36	2.48	2.48	1.42	2.36	1.97	1.97	174.61	FI-T-42/28/42L-W3
	42	28	42	250	51	40	43,5	40	60	63	63	41	60	50	50	77,33	FI-T-42/35/42L-W3
	1.65	1.10	1.65	3625	2.01	1.57	1.71	1.57	2.36	2.48	2.48	1.61	2.36	1.97	1.97	170.13	FI-T-42/35/42L-W3
	42	35	42	250	51	40	40,5	40	62	63	63	50	60	50	50	80,30	FI-T-42/35/42L-W3
	1.65	1.38	1.65	3625	2.01	1.57	1.59	1.57	2.44	2.48	2.48	1.97	2.36	1.97	1.97	176.66	



**Tee Reducer**  
**Type FI-T • Series S**

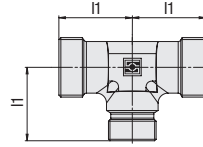
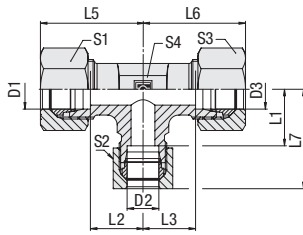

Sequence of connections  
in the ordering codes for  
tee reducers:



**D**

Series	Tube OD (mm/in)			PN (bar/psi)	Dimensions (mm/in)										Weight ( <sup>100</sup> /lbs) ca. per 100	Ordering Codes <sup>3</sup>	
	D1	D2	D3		L1	L2	L3	L5 <sup>1</sup>	L6 <sup>1</sup>	L7 <sup>1</sup>	S1	S2	S3	S4			
S	12	6	12	630	29	22	21,5	21,5	38,5	38,5	37	24	17	24	17	10,75	FI-T-12/06/12S-W3
	.47	.24	.47	9135	1.14	.87	.85	.85	1.52	1.52	1.46	.94	.67	.94	.67	23.70	
	12	8	12	630	29	22	21,5	21,5	38,5	38,5	37,5	24	19	24	17	10,59	FI-T-12/08/12S-W3
	.47	.31	.47	9135	1.14	.87	.85	.85	1.52	1.52	1.48	.94	.75	.94	.67	23.35	
	12	16	12	630	33	24,5	25,5	25,5	41	41	43	24	30	24	24	18,74	FI-T-12/16/12S-W3
	.47	.63	.47	9135	1.30	.96	1.00	1.00	1.61	1.61	1.69	.94	1.18	.94	.94	41.31	
	16	6	16	630	33	26	24,5	24,5	43	43	41	30	17	30	24	17,85	FI-T-16/06/16S-W3
	.63	.24	.63	9135	1.30	1.02	.96	.96	1.69	1.69	1.61	1.18	.67	1.18	.94	39.35	
	16	8	16	630	33	24,5	26	24,5	41	43	43	19	30	24	24	18,08	FI-T-16/08/16S-W3
	.63	.31	.63	9135	1.30	.96	1.02	.96	1.61	1.69	1.69	.75	1.18	.94	.94	39.78	
	16	10	16	630	33	25,5	24,5	24,5	42	43	43	22	30	24	24	18,12	FI-T-16/10/16S-W3
	.63	.39	.63	9135	1.30	1.00	.96	.96	1.65	1.69	1.69	.87	1.18	.94	.94	39.86	
	16	12	12	630	33	25,5	24,5	25,5	43	41	42	30	24	24	24	16,44	FI-T-16/12/12S-W3
	.63	.47	.47	9135	1.30	1.00	.96	1.00	1.69	1.61	1.65	1.18	.94	.94	.94	36.24	
	16	12	16	630	33	25,5	24,5	24,5	42	43	43	24	30	24	24	18,10	FI-T-16/12/16S-W3
	.63	.47	.63	9135	1.30	1.00	.96	.96	1.65	1.69	1.69	.94	1.18	.94	.94	39.82	
	16	16	10	630	33	24,5	24,5	25,5	43,5	39,5	43,5	30	30	22	24	17,98	FI-T-16/16/10S-W3
	.63	.63	.39	9135	1.30	.96	.96	1.00	1.71	1.56	1.71	1.18	1.18	.87	.94	39.64	
	16	20	16	420	37	26,5	28,5	28,5	47	47	47	30	36	30	27	26,02	FI-T-16/20/16S-W3
	.63	.79	.63	6091	1.46	1.04	1.12	1.12	1.85	1.85	1.85	1.18	1.42	1.18	1.06	57.36	
	20	10	20	420	37	29,5	26,5	26,5	46	48	48	22	36	27	27	28,30	FI-T-20/10/20S-W3
	.79	.39	.79	6091	1.46	1.16	1.04	1.04	1.81	1.89	1.89	.87	1.42	1.06	1.06	62.26	
	20	12	20	420	37	29,5	26,5	26,5	48	48	45,5	36	24	36	27	26,42	FI-T-20/12/20S-W3
	.79	.47	.79	6091	1.46	1.16	1.04	1.04	1.89	1.89	1.79	1.42	.94	1.42	1.06	58.25	
	20	16	20	420	37	28,5	26,5	26,5	47	48	48	30	36	27	27	26,21	FI-T-20/16/20S-W3
	.79	.63	.79	6091	1.46	1.12	1.04	1.04	1.85	1.89	1.89	1.18	1.42	1.06	1.06	57.66	
	20	25	20	420	42	30	31,5	31,5	52	52	54	36	46	36	36	45,59	FI-T-20/25/20S-W3
	.79	.98	.79	6091	1.65	1.18	1.24	1.24	2.05	2.05	2.13	1.42	1.81	1.42	1.42	100.51	
	25	12	25	420	42	34,5	30	30	54	54	51	46	24	46	36	40,90	FI-T-25/12/25S-W3
	.98	.47	.98	6091	1.65	1.36	1.18	1.18	2.13	2.13	2.01	1.81	.94	1.81	1.42	103.40	
	25	16	25	420	42	33,5	30	30	52	54	54	30	46	36	36	45,80	FI-T-25/16/25S-W3
	.98	.63	.98	6091	1.65	1.32	1.18	1.18	2.05	2.13	2.13	1.18	1.81	1.42	1.42	100.76	
	25	20	25	420	42	31,5	30	30	53	54	54	36	46	36	36	45,04	FI-T-25/20/25S-W3
	.98	.79	.98	6091	1.65	1.24	1.18	1.18	2.09	2.13	2.13	1.42	1.81	1.42	1.42	99.08	
	25	30	25	420	49	37	35,5	37	62	61	61	50	46	41	41	72,40	FI-T-25/30/25S-W3
	.98	1.18	.98	6091	1.93	1.46	1.40	1.46	2.44	2.40	2.40	1.97	1.81	1.61	1.61	159.28	
	30	20	30	420	49	35,5	38,5	35,5	48	62	62	36	50	41	41	80,00	FI-T-30/20/30S-W3
	1.18	.79	1.18	6091	1.93	1.40	1.52	1.40	1.89	2.44	2.44	1.42	1.97	1.61	1.61	176.00	
	38	20	38	420	57	46,5	41	41	72,5	72,5	68	60	36	60	50	108,90	FI-T-38/20/38S-W3
	1.18	.79	1.50	6091	2.24	1.83	1.61	1.61	2.85	2.85	2.68	2.36	1.42	2.36	1.97	240.08	
	38	25	38	420	57	41	45	41	69	72	72	46	60	50	50	134,72	FI-T-38/25/38S-W3
	1.50	.98	1.50	6091	2.24	1.61	1.77	1.61	2.72	2.83	2.83	1.81	2.36	1.97	1.97	296.38	
	38	30	38	400	57	41	43,5	41	70	72	72	50	60	50	50	125,00	FI-T-38/30/38S-W3
	1.50	1.18	1.50	5800	2.24	1.61	1.71	1.61	2.76	2.83	2.83	1.97	2.36	1.97	1.97	275.00	

**Ordering Codes**

**\*FI-T\*-12/\*06/\*12\*S\*-W3\*-MS**

- \* Tee Reducer FI-T
- \* Outside Tube Diameter D1 (in mm) -12
- \* Outside Tube Diameter D2 (in mm) 06
- \* Outside Tube Diameter D3 (in mm) 12
- \* Series L  
Light Series (page 101/102)
- S Heavy Series (page 103)
- \* Material Code -W3  
Steel, zinc/nickel-plated
- Please contact STAUFF for alternative materials and surface finishings.
- \* Assembling / Kitting —  
Fitting body only
- MS Fitting body supplied with cutting rings and union nuts
- MSV Fitting body supplied with soft-sealing cutting rings and union nuts

**Connecting Parts**

-  Cutting Ring  
Type **FI-DS** Page 28
-  Soft-Sealing Cutting Ring  
Type **FI-WDDS** Page 29
-  Support Sleeve  
Type **FI-VH** Page 31
-  STAUFF Form EVO Sealing Ring  
Type **FI-FD** Page 32
-  Union Nut  
Type **FI-M** Page 33
-  37° Flared Tube Fitting Set  
Type **FI-AB** Page 37

<sup>1</sup> Approximate dimension in assembled condition.

<sup>2</sup> Weight excluding cutting rings and union nuts.

<sup>3</sup> Standard scope of delivery: Fitting body only.



**Equal Cross**  
**Type FI-K • Series LL / L / S**

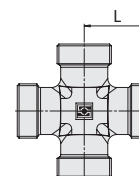
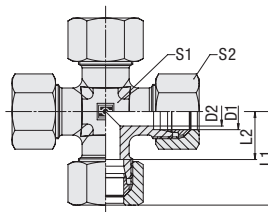

D

**Ordering Codes**

**\*FI-K\*-10\*L\*-W3\*-MS**

- \* Equal Cross **FI-K**
- \* Outside Tube Diameter D1 (in mm) **-10**
- \* Series **LL**  
 Extra-Light Series **L**  
 Light Series **S**  
 Heavy Series
- \* Material Code **-W3**  
 Steel, zinc/nickel-plated
- Please contact STAUFF for alternative materials and surface finishings.
- \* Assembling / Kitting **—**  
 Fitting body only
- Fitting body supplied with cutting rings and union nuts **-MS**
- Fitting body supplied with soft-sealing cutting rings and union nuts **-MSV**

**Connecting Parts**

- Cutting Ring  
Type **FI-DS** Page 28
- Soft-Sealing Cutting Ring  
Type **FI-WDDS** Page 29
- Support Sleeve  
Type **FI-VH** Page 31
- STAUFF Form EVO Sealing Ring  
Type **FI-FD** Page 32
- Union Nut  
Type **FI-M** Page 33
- 37° Flared Tube Fitting Set  
Type **FI-AB** Page 37

Series	Tube OD		Dimensions						Weight (kg/lbs) ca. per 100	Ordering Codes <sup>3</sup>
	(mm/in)	PN (bar/psi)	D1	D2	L	L1 <sup>1</sup>	L2	S1		
LL	4	100	3	15	21	11	9	10	1,68	FI-K-04LL-W3
	.16	1450	.12	.59	.83	.43	.35	.39	3.69	
	6	100	4,5	15	21	9,5	9	12	1,76	FI-K-06LL-W3
	.24	1450	.18	.59	.83	.37	.35	.47	3.87	
	8	100	6	17	23	11,5	12	14	2,85	FI-K-08LL-W3
L	.31	1450	.24	.67	.91	.45	.47	.55	6.27	
	6	500	4	19	27	12	12	14	3,40	FI-K-06L-W3
	.24	7250	.16	.75	1.06	.47	.47	.55	7.48	
	8	500	6	21	29	14	12	17	3,93	FI-K-08L-W3
	.31	7250	.24	.83	1.14	.55	.47	.67	8.64	
	10	500	8	22	30	15	14	19	5,01	FI-K-10L-W3
	.39	7250	.31	.87	1.18	.59	.55	.75	11.02	
	12	400	10	24	32	17	17	22	6,90	FI-K-12L-W3
	.47	5800	.39	.94	1.26	.67	.67	.87	15.19	
	15	400	12	28	36	21	19	27	12,36	FI-K-15L-W3
	.59	5800	.47	1.10	1.42	.83	.75	1.06	27.19	
	18	400	15	31	40	23,5	24	32	17,40	FI-K-18L-W3
	.71	5800	.59	1.22	1.57	.93	.94	1.26	38.28	
	22	250	19	35	44	27,5	27	36	22,60	FI-K-22L-W3
	.87	3625	.75	1.38	1.73	1.08	1.06	1.42	49.72	
	28	250	24	38	47	30,5	36	41	35,60	FI-K-28L-W3
	1.10	3625	.94	1.50	1.85	1.20	1.42	1.61	78.32	
	35	250	30	45	56	34,5	41	50	54,67	FI-K-35L-W3
1.38	3625	1.18	1.77	2.20	1.36	1.61	1.97	120.27		
42	250	36	51	63	40	50	60	92,70	FI-K-42L-W3	
1.65	3625	1.42	2.01	2.48	1.57	1.97	2.36	209.30		
S	6	800	4	23	31	16	12	17	5,79	FI-K-06S-W3
	.24	11600	.16	.91	1.22	.63	.47	.67	12.74	
	8	800	5	24	32	17	14	19	7,91	FI-K-08S-W3
	.31	11600	.20	.94	1.26	.67	.55	.75	17.41	
	10	800	7	25	34	17,5	17	22	10,13	FI-K-10S-W3
	.39	11600	.28	.98	1.34	.69	.67	.87	22.28	
	12	630	8	29	38	21,5	17	24	13,59	FI-K-12S-W3
	.47	9135	.31	1.14	1.50	.85	.67	.94	29.90	
	14	630	10	30	40	22	19	27	16,21	FI-K-14S-W3
	.55	9135	.39	1.18	1.57	.87	.75	1.06	35.65	
	16	630	12	33	43	24,5	24	30	22,15	FI-K-16S-W3
	.63	9135	.47	1.30	1.69	.96	.94	1.18	48.73	
	20	420	16	37	48	26,5	27	36	31,07	FI-K-20S-W3
	.79	6091	.63	1.46	1.89	1.04	1.06	1.42	68.35	
	25	420	20	42	54	30	36	46	53,00	FI-K-25S-W3
.98	6091	.79	1.65	2.13	1.18	1.42	1.81	116.60		
30	420	25	49	62	35,5	41	50	84,30	FI-K-30S-W3	
1.18	6091	.98	1.93	2.44	1.40	1.61	1.97	185.46		
38	420	32	57	72	41	50	60	135,10	FI-K-38S-W3	
1.50	6091	1.26	2.24	2.83	1.61	1.97	2.36	297.22		

<sup>1</sup> Approximate dimension in assembled condition.

<sup>2</sup> Weight excluding cutting rings and union nuts.

<sup>3</sup> Standard scope of delivery: Fitting body only.





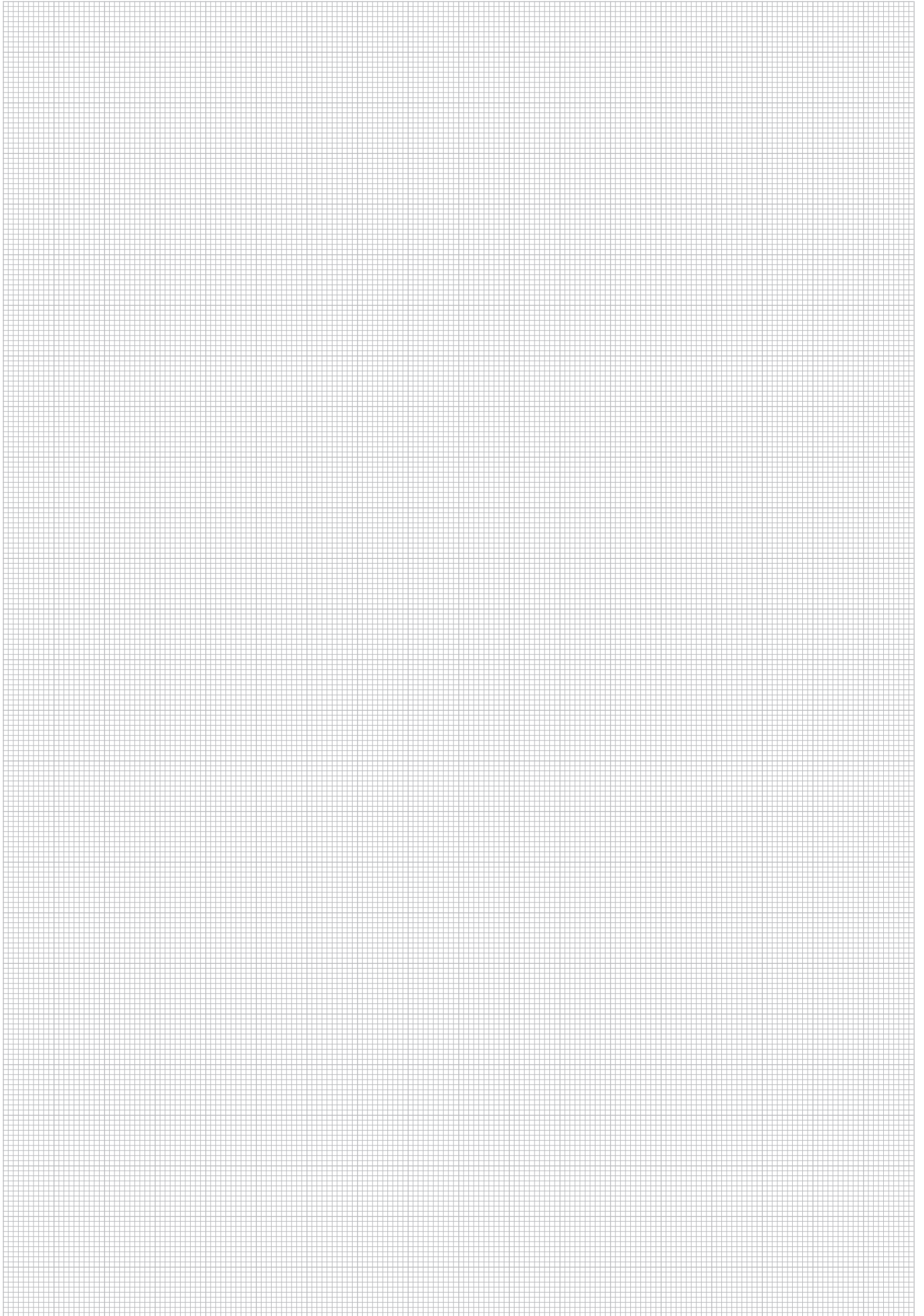



**Straight Bulkhead Fitting**

FI-GS

108

**Elbow Bulkhead Fittings**

FI-WS

109

**Straight Bulkhead Weld Fitting**

FI-ES

110



**Straight Bulkhead Fitting**  
Type FI-GS • Series L / S

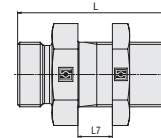
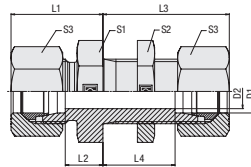

E

**Ordering Codes**

**\*FI-GS\*-10\*L\*-W3\*-MS**

- \* Straight Bulkhead Fitting FI-GS
- \* Outside Tube Diameter D1 (in mm) -10
- \* Series L  
S
  - Light Series
  - Heavy Series
- \* Material Code -W3
  - Steel, zinc/nickel-plated
- Please contact STAUFF for alternative materials and surface finishings.
- \* Assembling / Kitting —
  - Fitting body only
  - Fitting body supplied with hexagon lock nut -SKM
  - Fitting body supplied with cutting rings and union nuts -MS
  - Fitting body supplied with soft-sealing cutting rings and union nuts -MSV

**Connecting Parts**

-  Cutting Ring  
Type **FI-DS** Page 28
-  Soft-Sealing Cutting Ring  
Type **FI-WDDS** Page 29
-  Support Sleeve  
Type **FI-VH** Page 31
-  STAUFF Form EVO Sealing Ring  
Type **FI-FD** Page 32
-  Union Nut  
Type **FI-M** Page 33
-  37° Flared Tube Fitting Set  
Type **FI-AB** Page 37

**Spare Parts / Accessories**

-  Hexagon Lock Nut  
Type **FI-SKM** Page 237

Series	Tube OD (mm/in)	PN (bar/psi)	Dimensions (mm/in)											Weight (kg/lbs) Ca. per 100	Ordering Codes <sup>3</sup>
			D1	D2	L	L1 <sup>1</sup>	L2	L3 <sup>1</sup>	L4	L7 max	S1	S2	S3		
L	6	500	4	48	22	7	42	27	16	17	17	14	3,85	FI-GS-06L-W3-SKM	
	.24	7250	.16	1.89	.87	.28	1.65	1.06	.63	.67	.67	.55	8.48		
	8	500	6	49	23	8	42	27	16	19	19	17	4,93	FI-GS-08L-W3-SKM	
	.31	7250	.24	1.93	.91	.31	1.65	1.06	.63	.75	.75	.67	10.85		
	10	500	8	52	25	10	43	28	16	22	22	19	6,76	FI-GS-10L-W3-SKM	
	.39	7250	.31	2.05	.98	.39	1.69	1.10	.63	.87	.87	.75	14.87		
	12	400	10	53	25	10	44	29	16	24	24	22	7,81	FI-GS-12L-W3-SKM	
	.47	5800	.39	2.09	.98	.39	1.73	1.14	.63	.94	.94	.87	17.18		
	15	400	12	57	27	12	46	31	16	27	30	27	12,89	FI-GS-15L-W3-SKM	
	.59	5800	.47	2.24	1.06	.47	1.81	1.22	.63	1.06	1.18	1.06	28.37		
	18	400	15	61	30	13,5	49	32,5	16	32	36	32	19,87	FI-GS-18L-W3-SKM	
	.71	5800	.59	2.40	1.18	.53	1.93	1.28	.63	1.26	1.42	1.26	43.72		
	22	250	19	66	33	16,5	51	34,5	16	36	41	36	25,19	FI-GS-22L-W3-SKM	
	.87	3625	.75	2.60	1.30	.65	2.01	1.36	.63	1.42	1.61	1.42	55.42		
	28	250	24	69	35	18,5	52	35,5	16	41	46	41	34,12	FI-GS-28L-W3-SKM	
	1.10	3625	.94	2.72	1.38	.73	2.05	1.40	.63	1.61	1.81	1.61	75.07		
	35	250	30	76	40	18,5	58	36,5	16	50	55	50	55,40	FI-GS-35L-W3-SKM	
	1.38	3625	1.18	2.99	1.57	.73	2.28	1.44	.63	1.97	2.17	1.97	121.88		
42	250	36	77	42	19	59	36	16	60	65	60	75,30	FI-GS-42L-W3-SKM		
1.65	3625	1.42	3.03	1.65	.75	2.32	1.42	.63	2.36	2.56	2.36	165.66			
S	6	800	4	55	27	12	44	29	16	19	19	17	6,50	FI-GS-06S-W3-SKM	
	.24	11600	.16	2.17	1.06	.47	1.73	1.14	.63	.75	.75	.67	14.30		
	8	800	5	56	28	13	44	29	16	22	22	19	8,84	FI-GS-08S-W3-SKM	
	.31	11600	.20	2.20	1.10	.51	1.73	1.14	.63	.87	.87	.75	19.44		
	10	800	7	59	31	14,5	46	29,5	16	24	24	22	11,18	FI-GS-10S-W3-SKM	
	.39	11600	.28	2.32	1.22	.57	1.81	1.16	.63	.94	.94	.87	24.59		
	12	630	8	60	31	14,5	47	30,5	16	27	27	24	14,00	FI-GS-12S-W3-SKM	
	.47	9135	.31	2.36	1.22	.57	1.85	1.20	.63	1.06	1.06	.94	30.80		
	14	630	10	65	35	17	50	32	16	30	30	27	18,17	FI-GS-14S-W3-SKM	
	.55	9135	.39	2.56	1.38	.67	1.97	1.26	.63	1.18	1.18	1.06	39.97		
	16	630	12	65	35	16,5	50	31,5	16	32	32	30	20,12	FI-GS-16S-W3-SKM	
	.63	9135	.47	2.56	1.38	.65	1.97	1.24	.63	1.26	1.26	1.18	44.27		
	20	420	16	72	39	17,5	55	33,5	16	41	41	36	34,45	FI-GS-20S-W3-SKM	
	.79	6091	.63	2.83	1.54	.69	2.17	1.32	.63	1.61	1.61	1.42	75.79		
	25	420	20	79	44	20	59	35	16	46	46	46	49,56	FI-GS-25S-W3-SKM	
	.98	6091	.79	3.11	1.73	.79	2.32	1.38	.63	1.81	1.81	1.81	109.04		
	30	420	25	86	48	21,5	64	37,5	16	50	50	50	64,90	FI-GS-30S-W3-SKM	
	1.18	6091	.98	3.39	1.89	.85	2.52	1.48	.63	1.97	1.97	1.97	142.78		
38	420	32	91	53	22	68	37	16	65	65	60	108,30	FI-GS-38S-W3-SKM		
1.50	6091	1.26	3.58	2.09	.87	2.68	1.46	.63	2.56	2.56	2.36	238.26			

<sup>1</sup> Approximate dimension in assembled condition.  
<sup>2</sup> Weight excluding lock nut, cutting rings and union nuts.  
<sup>3</sup> Standard scope of delivery: Fitting body with hexagon lock nut.



Elbow Bulkhead Fittings  
Type FI-WS • Series L / S

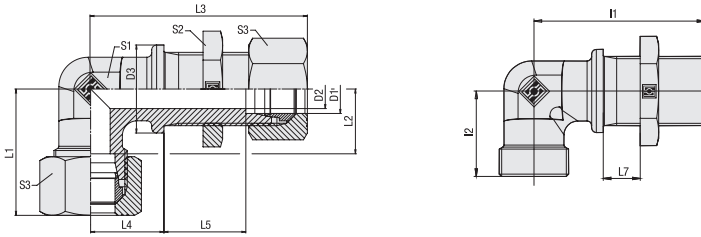

Series	Tube OD (mm/in)	PN (bar/PSI)	Dimensions (mm/in)													Weight (kg/lbs) ca. per 100	Ordering Codes <sup>3</sup>	
			D1	D2	L	i1	i2	L1 <sup>1</sup>	L2	L3 <sup>1</sup>	L4	L5	L7 <sub>min</sub>	L7 <sub>max</sub>	S1			S2
L	6	500	4	17	48	19	27	12	56	14	27	3	16	12	17	14	4,88	FI-WS-06L-W3-SKM
	.24	7252	.16	.67	1.89	.75	1.06	.47	2.20	.55	1.06	.12	.63	.47	.67	.55	10,74	
	8	500	6	19	51	21	29	14	59	17	27	3	16	12	19	17	6,11	FI-WS-08L-W3-SKM
	.31	7252	.24	.75	2.01	.83	1.14	.55	2.32	.67	1.06	.12	.63	.47	.75	.67	13,43	
	10	500	8	22	53	22	30	15	61	18	28	3	16	14	22	19	7,89	FI-WS-10L-W3-SKM
	.39	7252	.31	.87	2.09	.87	1.18	.59	2.40	.71	1.10	.12	.63	.55	.87	.75	17,35	
	12	400	10	24	56	24	32	17	64	20	29	3	16	17	24	22	9,65	FI-WS-12L-W3-SKM
	.47	5802	.39	.94	2.20	.94	1.26	.67	2.52	.79	1.14	.12	.63	.67	.94	.87	21,23	
	15	400	12	27	61	28	36	21	69	23	31	3	16	19	30	27	16,31	FI-WS-15L-W3-SKM
	.59	5802	.47	1.06	2.40	1.10	1.42	.83	2.72	.91	1.22	.12	.63	.75	1.18	1.06	35,88	
	18	400	15	32	64	31	40	23,5	73	24	32,5	3	16	24	36	32	23,82	FI-WS-18L-W3-SKM
	.71	5802	.59	1.26	2.52	1.22	1.57	.93	2.87	.94	1.28	.12	.63	.94	1.42	1.26	52,40	
	22	250	19	36	72	35	44	27,5	81	30	34,5	4	16	27	41	36	30,41	FI-WS-22L-W3-SKM
	.87	3626	.75	1.42	2.83	1.38	1.73	1.08	3.19	1.18	1.36	.16	.63	1.06	1.61	1.42	66,90	
	28	250	24	42	77	38	47	30,5	86	34	35,5	4	16	36	46	41	45,92	FI-WS-28L-W3-SKM
	1.10	3626	.94	1.65	3.03	1.50	1.85	1.20	3.39	1.34	1.40	.16	.63	1.42	1.81	1.61	101,03	
	35	250	30	50	86	45	56	34,5	97	39	36,5	4	16	41	55	50	75,00	FI-WS-35L-W3-SKM
	1.38	3626	1.18	1.97	3.39	1.77	2.20	1.36	3.82	1.54	1.44	.16	.63	1.61	2.17	1.97	165,00	
42	250	36	60	90	51	63	40	102	43	36	4	16	50	65	60	107,00	FI-WS-42L-W3-SKM	
1.65	3626	1.42	2.36	3.54	2.01	2.48	1.57	4.02	1.69	1.42	.16	.63	1.97	2.56	2.36	235,40		
S	6	800	4	19	53	23	31	16	61	17	29	3	16	12	19	17	7,34	FI-WS-06S-W3-SKM
	.24	11603	.16	.75	2.09	.91	1.22	.63	2.40	.67	1.14	.12	.63	.47	.75	.67	16,15	
	8	800	5	22	54	24	32	17	62	18	29	3	16	14	22	19	10,16	FI-WS-08S-W3-SKM
	.31	11603	.20	.87	2.13	.94	1.26	.67	2.44	.71	1.14	.12	.63	.55	.87	.75	22,35	
	10	800	7	24	57	25	34	17,5	66	20	29,5	3	16	17	24	22	12,59	FI-WS-10S-W3-SKM
	.39	11603	.28	.94	2.24	.98	1.34	.69	2.60	.79	1.16	.12	.63	.67	.94	.87	27,71	
	12	630	8	27	59	29	38	21,5	68	21	30,5	3	16	17	27	24	16,05	FI-WS-12S-W3-SKM
	.47	9137	.31	1.06	2.32	1.14	1.50	.85	2.68	.83	1.20	.12	.63	.67	1.06	.94	35,30	
	14	630	10	27	63	30	40	22	73	23	32	3	16	19	30	27	19,62	FI-WS-14S-W3-SKM
	.55	9137	.39	1.06	2.48	1.18	1.57	.87	2.87	.91	1.26	.12	.63	.75	1.18	1.06	43,17	
	16	630	12	30	64	33	43	24,5	74	24	31,5	3	16	24	32	30	24,14	FI-WS-16S-W3-SKM
	.63	9137	.47	1.18	2.52	1.30	1.69	.96	2.91	.94	1.24	.12	.63	.94	1.26	1.18	53,10	
	20	400	16	36	74	37	48	26,5	85	30	33,5	4	16	27	41	36	38,01	FI-WS-20S-W3-SKM
	.79	5802	.63	1.42	2.91	1.46	1.89	1.04	3.35	1.18	1.32	.16	.63	1.06	1.61	1.42	83,63	
	25	400	20	42	81	42	54	30	93	34	35	4	16	36	46	46	61,10	FI-WS-25S-W3-SKM
	.98	5802	.79	1.65	3.19	1.65	2.13	1.18	3.66	1.34	1.38	.16	.63	1.42	1.81	1.81	134,42	
	30	400	25	50	90	49	62	35,5	103	39	37,5	4	16	41	50	50	91,00	FI-WS-30S-W3-SKM
	1.18	5802	.98	1.97	3.54	1.93	2.44	1.40	4.06	1.54	1.48	.16	.63	1.61	1.97	1.97	200,20	
38	400	32	60	96	57	72	41	112	43	37	4	16	50	65	60	138,90	FI-WS-38S-W3-SKM	
1.50	5802	1.26	2.36	3.78	2.24	2.83	1.61	4.41	1.69	1.46	.16	.63	1.97	2.56	2.36	305,58		

<sup>1</sup> Approximate dimension in assembled condition.  
<sup>2</sup> Weight excluding cutting rings and union nuts.  
<sup>3</sup> Standard scope of delivery: Fitting body only.

### Ordering Codes

**\*FI-WS\*-10\*L\*-W3\*-MS**

- \* Elbow Bulkhead Fitting **FI-WS**
- \* Outside Tube Diameter D1 (in mm) **-10**
- \* Series Light Series **L**  
Heavy Series **S**
- \* Material Code Steel, zinc/nickel-plated **-W3**

Please contact STAUFF for alternative materials and surface finishings.

\* Assembling / Kitting Fitting body only **—**

- Fitting body supplied with hexagon lock nut **-SKM**
- Fitting body supplied with cutting rings and union nuts **-MS**
- Fitting body supplied with soft-sealing cutting rings and union nuts **-MSV**

### Connecting Parts

- Cutting Ring Type **FI-DS** Page 28
- Soft-Sealing Cutting Ring Type **FI-WDDS** Page 29
- Support Sleeve Type **FI-VH** Page 31
- STAUFF Form EVO Sealing Ring Type **FI-FD** Page 32
- Union Nut Type **FI-M** Page 33
- 37° Flared Tube Fitting Set Type **FI-AB** Page 37

### Spare Parts / Accessories

- Hexagon Lock Nut Type **FI-SKM** Page 237

E



**Straight Bulkhead Weld Fitting**  
Type FI-ES • Series L / S

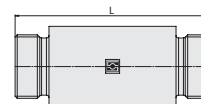
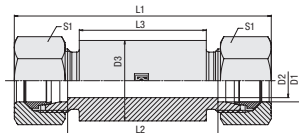

E

**Ordering Codes**

**\*FI-ES\*-10\*L\*-W159\*-MS**

- \* Straight Bulkhead Weld Fitting **FI-ES**
- \* Outside Tube Diameter D1 (in mm) **-10**
- \* Series **L**  
Light Series  
Heavy Series **S**
- \* Material Code **-W2**  
Steel, phosphated  
Fitting body:  
Steel, phosphated **-W159**  
Connecting parts:  
Steel, zinc/nickel-plated **-MSV**
- Please contact STAUFF for alternative materials and surface finishings.
- \* Assembling / Kitting **—**  
Fitting body only  
Fitting body supplied with cutting rings and union nuts **-MS**  
Fitting body supplied with soft-sealing cutting rings and union nuts **-MSV**

**Connecting Parts**

- Cutting Ring  
Type **FI-DS** Page 28
- Soft-Sealing Cutting Ring  
Type **FI-WDDS** Page 29
- Support Sleeve  
Type **FI-VH** Page 31
- STAUFF Form EVO Sealing Ring  
Type **FI-FD** Page 32
- Union Nut  
Type **FI-M** Page 33
- 37° Flared Tube Fitting Set  
Type **FI-AB** Page 37

Series	Tube OD	PN	Dimensions							Weight (kg/lbs) ca. per 100	Ordering Codes <sup>3</sup>
	(mm/in) D1		(mm/in) D2	(mm/in) D3	L	L1 <sup>1</sup>	L2	L3	S1		
L	6	500	4	18	70	85	56	50	14	10,33	FI-ES-06L-W2
	.24	7252	.16	.71	2.76	3.35	2.20	1.97	.55	22.73	
	8	500	6	20	70	85	56	50	17	12,21	FI-ES-08L-W2
	.31	7252	.24	.79	2.76	3.35	2.20	1.97	.67	26.87	
	10	500	8	22	72	87	58	50	19	14,30	FI-ES-10L-W2
	.39	7252	.31	.87	2.83	3.43	2.28	1.97	.75	31.46	
	12	400	10	25	72	87	58	50	22	17,75	FI-ES-12L-W2
	.47	5802	.39	.98	2.83	3.43	2.28	1.97	.87	39.05	
	15	400	12	28	84	100	70	60	27	26,69	FI-ES-15L-W2
	.59	5802	.47	1.10	3.31	3.94	2.76	2.36	1.06	58.73	
	18	400	15	32	84	101	69	60	32	33,60	FI-ES-18L-W2
	.71	5802	.59	1.26	3.31	3.98	2.72	2.36	1.26	73.92	
	22	250	19	36	88	105	73	60	36	39,92	FI-ES-22L-W2
	.87	3626	.75	1.42	3.46	4.13	2.87	2.36	1.42	87.83	
	28	250	24	40	88	106	73	60	41	45,18	FI-ES-28L-W2
	1.10	3626	.94	1.57	3.46	4.17	2.87	2.36	1.61	99.40	
	35	250	30	50	92	114	71	60	50	72,80	FI-ES-35L-W2
	1.38	3626	1.18	1.97	3.62	4.49	2.80	2.36	1.97	160.16	
	42	250	36	60	92	115	70	60	60	100,60	FI-ES-42L-W2
	1.65	3626	1.42	2.36	3.62	4.53	2.76	2.36	2.36	221.32	
S	6	800	4	20	74	89	60	50	17	13,56	FI-ES-06S-W2
	.24	11603	.16	.79	2.91	3.50	2.36	1.97	.67	29.83	
	8	800	5	22	74	89	60	50	19	16,35	FI-ES-08S-W2
	.31	11603	.20	.87	2.91	3.50	2.36	1.97	.75	35.96	
	10	800	7	25	74	91	59	50	22	20,24	FI-ES-10S-W2
	.39	11603	.28	.98	2.91	3.58	2.32	1.97	.87	44.52	
	12	630	8	28	74	91	59	50	24	25,17	FI-ES-12S-W2
	.47	9137	.31	1.10	2.91	3.58	2.32	1.97	.94	55.38	
	14	630	10	30	88	107	72	60	27	33,72	FI-ES-14S-W2
	.55	9137	.39	1.18	3.46	4.21	2.83	2.36	1.06	74.18	
	16	630	12	35	88	107	71	60	30	44,42	FI-ES-16S-W2
	.63	9137	.47	1.38	3.46	4.21	2.80	2.36	1.18	97.72	
	20	420	16	38	92	114	71	60	36	51,50	FI-ES-20S-W2
	.79	6091	.63	1.50	3.62	4.49	2.80	2.36	1.42	113.30	
	25	420	20	45	96	120	72	60	46	72,50	FI-ES-25S-W2
	.98	6091	.79	1.77	3.78	4.72	2.83	2.36	1.81	159.50	
	30	420	25	50	100	126	73	60	50	87,80	FI-ES-30S-W2
	1.18	6091	.98	1.97	3.94	4.96	2.87	2.36	1.97	193.16	
38	420	32	60	104	133	72	60	60	125,30	FI-ES-38S-W2	
1.50	6091	1.26	2.36	4.09	5.24	2.83	2.36	2.36	275.66		

<sup>1</sup> Approximate dimension in assembled condition.

<sup>2</sup> Weight excluding cutting rings and union nuts.



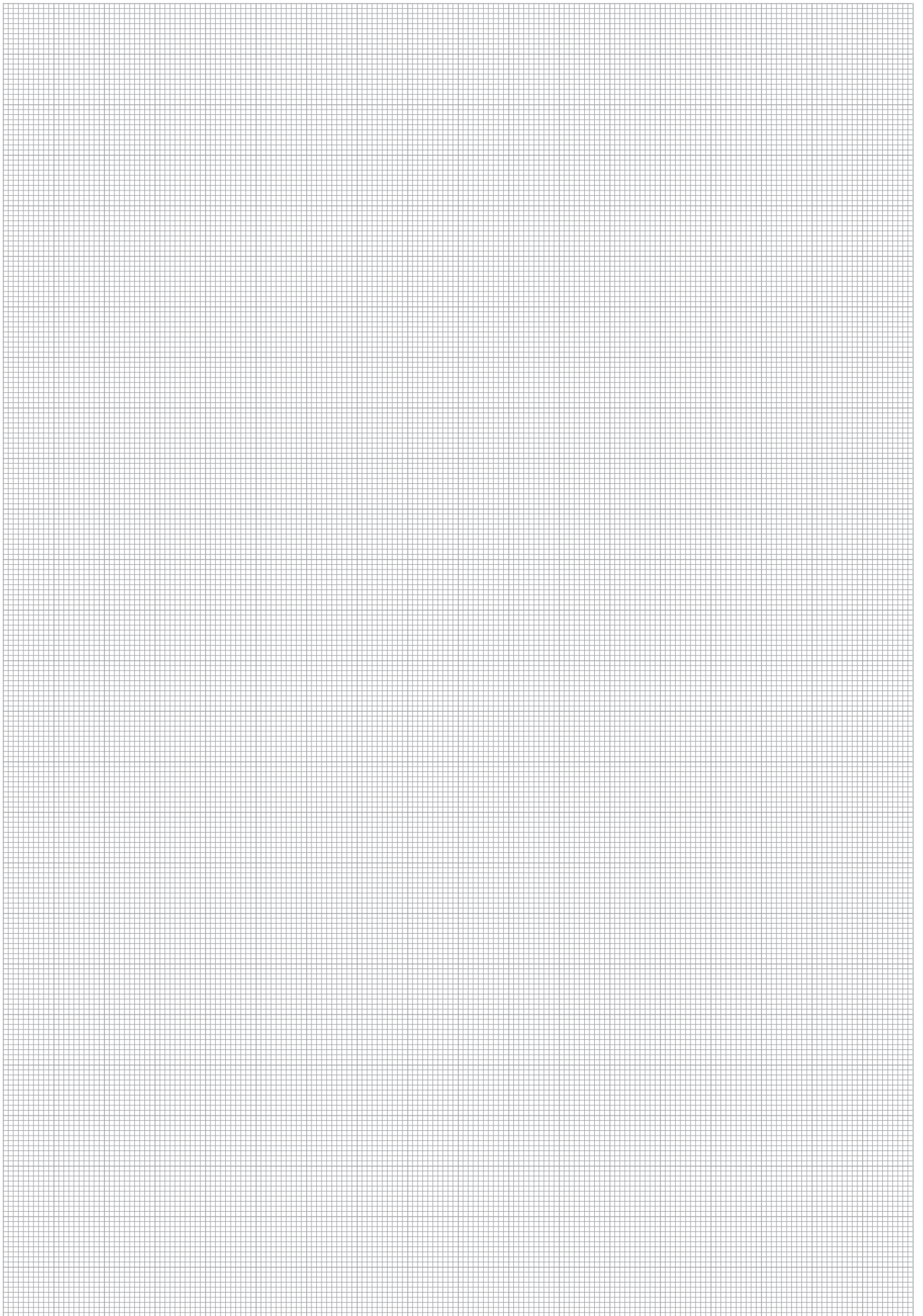

<sup>3</sup> Standard scope of delivery: Fitting body only.









	<b>Straight Weld Fitting</b> FI-AS	114
	<b>Elbow Weld Fitting</b> FI-WAS	115
	<b>24° Weld Cone with O-Ring</b> FI-SN	116
	<b>24° Weld Cone Reducer with O-Ring</b> FI-SNR	118
	<b>Straight Weld Fitting for Tubes</b> FI-ASV	120

**Straight Weld Fitting**  
Type FI-AS • Series L / S

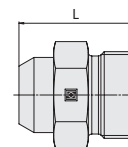
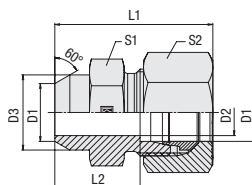

F

**Ordering Codes**

**\*FI-AS\*-10\*L\*-W159\*-MS**

- \* Straight Weld Fitting FI-AS
- \* Outside Tube Diameter D1 (in mm) -10
- \* Series L  
S
  - Light Series
  - Heavy Series
- \* Material Code -W2
  - Steel, phosphated
- W159
  - Fitting body:  
Steel, phosphated
  - Connecting parts:  
Steel, zinc/nickel-plated
- Please contact STAUFF for alternative materials and surface finishings.
- \* Assembling / Kitting —
  - Fitting body only
  - Fitting body supplied with cutting ring and union nut -MS
  - Fitting body supplied with soft-sealing cutting ring and union nut -MSV

**Connecting Parts**

- Cutting Ring  
Type **FI-DS** Page 28
- Soft-Sealing Cutting Ring  
Type **FI-WDDS** Page 29
- Support Sleeve  
Type **FI-VH** Page 31
- STAUFF Form EVO Sealing Ring  
Type **FI-FD** Page 32
- Union Nut  
Type **FI-M** Page 33
- 37° Flared Tube Fitting Set  
Type **FI-AB** Page 37

Series	Tube OD (mm/in)	PN (bar/psi)	Dimensions (mm/in)								Weight (kg/lbs) ca. per 100	Ordering Codes <sup>3</sup>
			D1	D2	D3	L	L <sup>1</sup>	L2	S1	S2		
L	6	500	4	10	21	29	14	12	14	1,06	FI-AS-06L-W2	
	.24	7252	.16	.39	.83	1.14	.55	.47	.55	2.33	FI-AS-08L-W2	
	8	500	6	12	23	31	16	14	17	1.52	FI-AS-08L-W2	
	.31	7252	.24	.47	.91	1.22	.63	.55	.67	3.35	FI-AS-10L-W2	
	10	500	8	14	25	33	18	17	19	2.20	FI-AS-10L-W2	
	.39	7252	.31	.55	.98	1.30	.71	.67	.75	4.83	FI-AS-12L-W2	
	12	400	10	16	25	33	18	19	22	2.57	FI-AS-12L-W2	
	.47	5802	.39	.63	.98	1.30	.71	.75	.87	5.66	FI-AS-15L-W2	
	15	400	12	19	29	37	22	22	27	4.37	FI-AS-15L-W2	
	.59	5802	.47	.75	1.14	1.46	.87	.87	1.06	9.62	FI-AS-18L-W2	
	18	400	15	22	31	40	23,5	27	32	6.70	FI-AS-18L-W2	
	.71	5802	.59	.87	1.22	1.57	.93	1.06	1.26	14.75	FI-AS-22L-W2	
	22	250	19	27	36	45	28,5	32	36	9.87	FI-AS-22L-W2	
	.87	3626	.75	1.06	1.42	1.77	1.12	1.26	1.42	21.72	FI-AS-28L-W2	
	28	250	24	32	38	47	30,5	41	41	16,10	FI-AS-28L-W2	
	1.10	3626	.94	1.26	1.50	1.85	1.20	1.61	1.61	35,42	FI-AS-35L-W2	
	35	250	30	40	43	54	32,5	46	50	23,43	FI-AS-35L-W2	
	1.38	3626	1.18	1.57	1.69	2.13	1.28	1.81	1.97	51,55	FI-AS-42L-W2	
	42	250	36	46	46	58	35	55	60	32,82	FI-AS-42L-W2	
	1.65	3626	1.42	1.81	1.81	2.28	1.38	2.17	2.36	72,21	FI-AS-06S-W2	
S	6	800	4	11	26	34	19	14	17	2,06	FI-AS-06S-W2	
	.24	11603	.16	.43	1.02	1.34	.75	.55	.67	4.53	FI-AS-08S-W2	
	8	800	5	13	28	36	21	17	19	3,12	FI-AS-08S-W2	
	.31	11603	.20	.51	1.10	1.42	.83	.67	.75	6.87	FI-AS-10S-W2	
	10	800	7	15	30	39	22,5	19	22	4,12	FI-AS-10S-W2	
	.39	11603	.28	.59	1.18	1.54	.89	.75	.87	9.06	FI-AS-12S-W2	
	12	630	8	17	32	41	24,5	22	24	4,80	FI-AS-12S-W2	
	.47	9137	.31	.67	1.26	1.61	.96	.87	.94	10,56	FI-AS-14S-W2	
	14	630	10	19	35	45	27	24	27	7,11	FI-AS-14S-W2	
	.55	9137	.39	.75	1.38	1.77	1.06	.94	1.06	15,64	FI-AS-16S-W2	
	16	630	12	21	35	45	26,5	27	30	8,36	FI-AS-16S-W2	
	.63	9137	.47	.83	1.38	1.77	1.04	1.06	1.18	18,38	FI-AS-20S-W2	
	20	400	16	26	40	51	29,5	32	36	13,01	FI-AS-20S-W2	
	.79	5802	.63	1.02	1.57	2.01	1.16	1.26	1.42	28,61	FI-AS-25S-W2	
	25	400	20	31	44	56	32	41	46	22,16	FI-AS-25S-W2	
	.98	5802	.79	1.22	1.73	2.20	1.26	1.61	1.81	48,75	FI-AS-30S-W2	
	30	400	25	36	49	62	35,5	46	50	23,12	FI-AS-30S-W2	
	1.18	5802	.98	1.42	1.93	2.44	1.40	1.81	1.97	50,86	FI-AS-38S-W2	
38	400	32	44	54	69	38	55	60	45,26	FI-AS-38S-W2		
1.50	5802	1.26	1.73	2.13	2.72	1.50	2.17	2.36	99,57			

<sup>1</sup> Approximate dimension in assembled condition.

<sup>2</sup> Weight excluding cutting ring and union nut.

<sup>3</sup> Standard scope of delivery: Fitting body only.

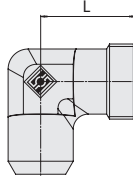
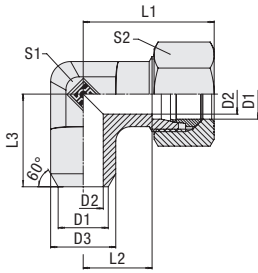

**Elbow Weld Fitting  
Type FI-WAS • Series L / S**

Series	Tube OD (mm/in)	PN (bar/PSI)	Dimensions (mm/in)								Weight (kg/lbs) ca. per 100	Ordering Codes <sup>3</sup>
			D1	D2	D3	L	L1 <sup>1</sup>	L2	L3	S1		
L	6	315	4	10	19	28	12	19	12	14	23	FI-WAS-06L-W2
	.24	4568	.16	.39	.75	1.10	.47	.75	.47	.55	50.71	FI-WAS-06L-W2
	8	315	6	12	21	29	14	23	12	17	2,56	FI-WAS-08L-W2
	.31	4568	.24	.47	.83	1.14	.55	.91	.47	.67	5.64	FI-WAS-08L-W2
	10	315	8	14	22	30	15	24	14	19	3,34	FI-WAS-10L-W2
	.39	4568	.31	.55	.87	1.18	.59	.94	.55	.75	7.34	FI-WAS-10L-W2
	12	315	10	16	24	32	17	25	17	22	4,52	FI-WAS-12L-W2
	.47	4568	.39	.63	.94	1.26	.67	.98	.67	.87	9.94	FI-WAS-12L-W2
	15	315	12	19	28	36	21	30	19	27	7,88	FI-WAS-15L-W2
	.59	4568	.47	.75	1.10	1.42	.83	1.18	.75	1.06	17.34	FI-WAS-15L-W2
	18	315	15	22	31	40	23,5	33	24	32	11,53	FI-WAS-18L-W2
	.71	4568	.59	.87	1.22	1.57	.93	1.30	.94	1.26	25.37	FI-WAS-18L-W2
	22	160	19	27	35	44	27,5	37	27	36	16,10	FI-WAS-22L-W2
	.87	2320	.75	1.06	1.38	1.73	1.08	1.46	1.06	1.42	35.41	FI-WAS-22L-W2
	28	160	24	32	38	47	30,5	42	36	41	5,99	FI-WAS-28L-W2
	1.10	2320	.94	1.26	1.50	1.85	1.20	1.65	1.42	1.61	13.17	FI-WAS-28L-W2
	35	160	30	40	45	56	34,5	49	41	50	42,27	FI-WAS-35L-W2
	1.38	2320	1.18	1.57	1.77	2.20	1.36	1.93	1.61	1.97	92.99	FI-WAS-35L-W2
42	160	36	46	51	63	40	57	50	60	65,80	FI-WAS-42L-W2	
1.65	2320	1.42	1.81	2.01	2.48	1.57	2.24	1.97	2.36	144.76	FI-WAS-42L-W2	
S	6	400	4	11	23	30	16	23	12	17	30,96	FI-WAS-06S-W2
	.24	5800	.16	.43	.91	1.18	.63	.91	.47	.67	68.26	FI-WAS-06S-W2
	8	400	5	13	24	31	17	24	14	19	43,75	FI-WAS-08S-W2
	.31	5800	.20	.51	.94	1.22	.67	.94	.55	.75	96.45	FI-WAS-08S-W2
	10	400	7	15	25	33	17,5	25	17	22	56,74	FI-WAS-10S-W2
	.39	5800	.28	.59	.98	1.30	.69	.98	.67	.87	125.10	FI-WAS-10S-W2
	12	400	8	17	29	38	21,5	29	17	24	8,03	FI-WAS-12S-W2
	.47	5800	.31	.67	1.14	1.50	.85	1.14	.67	.94	17.67	FI-WAS-12S-W2
	16	400	12	21	33	43	24,5	33	24	30	13,89	FI-WAS-16S-W2
	.63	5800	.47	.83	1.30	1.69	.96	1.30	.94	1.18	30.56	FI-WAS-16S-W2
	20	400	16	26	37	48	26,5	37	27	36	20,24	FI-WAS-20S-W2
	.79	5800	.63	1.02	1.46	1.89	1.04	1.46	1.06	1.42	44.54	FI-WAS-20S-W2
	25	400	20	31	42	54	30	42	36	46	35,01	FI-WAS-25S-W2
	.98	5800	.79	1.22	1.65	2.13	1.18	1.65	1.42	1.81	77.03	FI-WAS-25S-W2
	30	400	25	36	49	62	35,5	49	41	50	53,00	FI-WAS-30S-W2
1.18	5800	.98	1.42	1.93	2.44	1.40	1.93	1.61	1.97	116.60	FI-WAS-30S-W2	
38	315	32	44	57	72	41	57	50	60	83,70	FI-WAS-38S-W2	
1.50	4568	1.26	1.73	2.24	2.83	1.61	2.24	1.97	2.36	184.14	FI-WAS-38S-W2	

<sup>1</sup> Approximate dimension in assembled condition.

<sup>2</sup> Weight excluding cutting ring and union nut.

<sup>3</sup> Standard scope of delivery: Fitting body only.

**Ordering Codes**
**\*FI-WAS\*-10\*L\*-W159\*-MS**

* Elbow Weld Fitting	FI-WAS
* Outside Tube Diameter D1 (in mm)	-10
* Series	Light Series L Heavy Series S
* Material Code	Steel, phosphated -W2
	Fitting body: Steel, phosphated -W159
	Connecting parts: Steel, zinc/nickel-plated

Please contact STAUFF for alternative materials and surface finishings.

* Assembling / Kitting	Fitting body only	—
	Fitting body supplied with cutting ring and union nut	-MS
	Fitting body supplied with soft-sealing cutting ring and union nut	-MSV

**Connecting Parts**

	Cutting Ring Type FI-DS	Page 28
	Soft-Sealing Cutting Ring Type FI-WDDS	Page 29
	Support Sleeve Type FI-VH	Page 31
	STAUFF Form EVO Sealing Ring Type FI-FD	Page 32
	Union Nut Type FI-M	Page 33
	37° Flared Tube Fitting Set Type FI-AB	Page 37



24° Weld Cone with O-Ring  
Type FI-SN • Series L / S

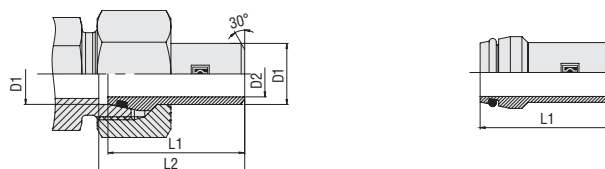

F

Ordering Codes

**\*FI-SN\*-10x1.5\*-B\*-W2**

- \* 24° Weld Cone with O-Ring **FI-SN**
- \* Outside Tube Diameter (in mm) **-10**
- \* Wall Thickness (in mm) **x1.5**
- \* Seal Material NBR (Buna-N®) **-B**  
FKM (Viton®) **-V**  
EPDM **-E**
- \* Material Code Steel, phosphated **-W2**

Please contact STAUFF for alternative materials and surface finishings.

**\*FI-SN\*-10\*L\*x1.5\*-B\*-W159\*-M**

- \* 24° Weld Cone with O-Ring **FI-SN**
- \* Outside Tube Diameter (in mm) **-10**
- \* Series Light Series (page 116) **L**  
Heavy Series (pages 117) **S**
- \* Wall Thickness (in mm) **x1.5**
- \* Seal Material NBR (Buna-N®) **-B**  
FKM (Viton®) **-V**  
EPDM **-E**
- \* Material Code Weld cone:  
Steel, phosphated **-W159**  
Union nut:  
Steel, zinc/nickel-plated

Please contact STAUFF for alternative materials and surface finishings.

- \* Assembling / Kitting 24° weld cone with O-ring supplied with union nut **-M**

Connecting Parts



Union Nut  
Type **FI-M**

Page 33

Spare Parts / Accessories



O-Ring  
Type **O-RING**

Page 239

Series	Tube OD		PN ( <sup>bar</sup> / <sub>psi</sub> )	Dimensions			Weight ( <sup>kg</sup> / <sub>lbs</sub> ) ca. per 100	Ordering Codes <sup>3</sup>
	D1	for Tube		D2	L1	L2		
L/S	6	6 x 1,5	400	3	31	32	0,70	FI-SN-6x1.5-B-W2
	.24	.24 x .06	5800	.12	1.22	1.26	1.54	
	8	8 x 1,5	315	5	31	32	0,90	FI-SN-8x1.5-B-W2
	.31	.31 x .06	4568	.20	1.22	1.26	1.98	
	8	8 x 2,0	400	4	31	32	1,10	FI-SN-8x2-B-W2
	.31	.31 x .08	5800	.16	1.22	1.26	2.42	
	10	10 x 1,0	250	8	32,5	33,5	0,89	FI-SN-10x1-B-W2
	.39	.39 x .03	3625	.31	1.28	1.32	1.96	
	10	10 x 1,5	250	7	32,5	33,5	1,30	FI-SN-10x1.5-B-W2
	.39	.39 x .06	3625	.28	1.28	1.32	2.86	
	10	10 x 2,0	315	6	32,5	33,5	1,60	FI-SN-10x2-B-W2
	.39	.39 x .08	4568	.24	1.28	1.32	3.52	
	10	10 x 2,5	400	5	32,5	33,5	1,80	FI-SN-10x2.5-B-W2
	.39	.39 x .10	5800	.20	1.28	1.32	3.96	
	12	12 x 1,5	160	9	32,5	33,5	1,60	FI-SN-12x1.5-B-W2
	.47	.47 x .06	2320	.35	1.28	1.32	3.52	
	12	12 x 2,0	250	8	32,5	33,5	1,90	FI-SN-12x2-B-W2
	.47	.47 x .08	3625	.31	1.28	1.32	4.18	
	12	12 x 2,5	315	7	32,5	33,5	2,20	FI-SN-12x2.5-B-W2
	.47	.47 x .10	4568	.28	1.28	1.32	4.84	
12	12 x 3,0	400	6	32,5	33,5	2,4	FI-SN-12x3-B-W2	
.47	.47 x .11	5800	.24	1.28	1.32	5.29		
L	15	15 x 2,0	250	11	35	36	2,70	FI-SN-15x2-B-W2
	.59	.59 x .08	3625	.43	1.38	1.42	5.93	
	15	15 x 2,5	315	10	35	36	3,00	FI-SN-15x2.5-B-W2
	.59	.59 x .10	4568	.39	1.38	1.42	6.60	
	18	18 x 2,0	160	14	36	37	3,76	FI-SN-18x2-B-W2
	.71	.71 x .08	2320	.55	1.42	1.46	8.27	
	18	18 x 2,5	315	18	36	37	3,79	FI-SN-18x2.5-B-W2
	.71	.71 x .10	4568	.71	1.42	1.46	8.36	
	22	22 x 2,0	160	22	38,5	39,5	4,46	FI-SN-22x2-B-W2
	.87	.87 x .08	2320	.87	1.52	1.56	9.83	
	22	22 x 2,5	160	17	38,5	39,5	5,21	FI-SN-22x2.5-B-W2
	.87	.87 x .10	2320	.67	1.52	1.56	11.45	
	22	22 x 3,0	160	16	38,5	39,5	5,72	FI-SN-22x3-B-W2
	.87	.87 x .12	2320	.63	1.52	1.56	12.61	
	28	28 x 2,5	160	23	41,5	42,5	7,27	FI-SN-28x2.5-B-W2
	1.10	1.10 x .10	2320	.91	1.63	1.67	15.99	
	28	28 x 3,0	160	22	41,5	42,5	8,34	FI-SN-28x3-B-W2
	1.10	1.1 x .12	2320	.87	1.63	1.67	18.34	
	35	35 x 3,0	160	29	47	49,5	12,62	FI-SN-35x3-B-W2
	1.38	1.38 x .12	2320	1.14	1.85	1.95	27.76	
35	35 x 3,5	160	28	47	49,5	14,05	FI-SN-35x3.5-B-W2	
1.38	1.38 x .14	2320	1.10	1.85	1.95	30.97		
35	35 x 4,0	160	27	47	49,5	15,59	FI-SN-35x4-B-W2	
1.38	1.38 x .16	2320	1.06	1.85	1.95	34.30		
42	42 x 3,0	160	36	47	50	15,13	FI-SN-42x3-B-W2	
1.65	1.65 x .12	2320	1.42	1.85	1.97	33.29		
42	42 x 4,0	160	34	47	50	19,10	FI-SN-42x4-B-W2	
1.65	1.65 x .16	2320	1.34	1.85	1.97	42.02		

<sup>1</sup> Approximate dimension in assembled condition.

<sup>2</sup> Weight excluding union nut.

<sup>3</sup> Standard scope of delivery: 24° weld cone and O-ring.

Standard seal material is NBR (Buna-N®).

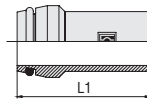
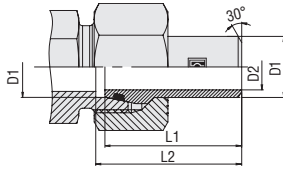

**24° Weld Cone with O-Ring  
Type FI-SN • Series S**

Series	Tube OD		PN (bar/psi)	Dimensions			Weight ( <sup>kg</sup> /lbs) ca. per 100	Ordering Codes <sup>3</sup>
	D1 (mm/in)	for Tube		D2 (mm/in)	L1	L2		
S	14	14 x 2,0	315	10	38,5	39,5	2,75	FI-SN-14x2-B-W2
	.55	.55 x .08	4568	.39	1.52	1.56	6.06	FI-SN-14x2.5-B-W2
	14	14 x 2,5	400	9	38,5	39,5	3,17	
	.55	.55 x .10	5800	.35	1.52	1.56	6.98	FI-SN-14x3-B-W2
	14	14 x 3,0	400	8	38,5	39,5	3,56	
	.55	.55 x .12	5800	.31	1.52	1.56	7.83	FI-SN-16x1.5-B-W2
	16	16 x 1,5	250	13	39	41	2,69	
	.63	.63 x .06	3625	.51	1.54	1.61	5.93	FI-SN-16x2-B-W2
	16	16 x 2,0	315	12	39	41	3,29	
	.63	.63 x .08	4568	.47	1.54	1.61	7.24	FI-SN-16x2.5-B-W2
	16	16 x 2,5	400	11	39	41	3,81	
	.63	.63 x .10	5800	.43	1.54	1.61	8.38	FI-SN-16x3-B-W2
	16	16 x 3,0	400	10	39	41	4,23	
	.63	.63 x .12	5800	.39	1.54	1.61	9.31	FI-SN-20x2-B-W2
	20	20 x 2,0	160	16	44,5	47	4,77	
	.79	.79 x .08	2320	.63	1.75	1.85	10.50	FI-SN-20x2.5-B-W2
	20	20 x 2,5	250	15	44,5	47	5,48	
	.79	.79 x .10	3625	.59	1.75	1.85	12.05	FI-SN-20x3-B-W2
	20	20 x 3,0	400	14	44,5	47	6,39	
	.79	.79 x .12	5800	.55	1.75	1.85	14.05	FI-SN-20x3.5-B-W2
	20	20 x 3,5	400	13	44,5	47	7,15	
	.79	.79 x .14	5800	.51	1.75	1.85	15.76	FI-SN-20x4-B-W2
	20	20 x 4,0	400	12	44,5	47	7,73	
	.79	.79 x .16	5800	.47	1.75	1.85	17.01	FI-SN-25x2.5-B-W2
	25	25 x 2,5	250	20	49,5	53,5	7,89	
	.98	.98 x .10	3625	.79	1.95	2.11	17.39	FI-SN-25x3-B-W2
	25	25 x 3,0	315	19	49,5	53,5	9,00	
	.98	.98 x .12	4568	.75	1.95	2.11	19.80	FI-SN-25x4-B-W2
	25	25 x 4,0	400	17	49,5	53,5	10,89	
	.98	.98 x .16	5800	.67	1.95	2.11	23.97	FI-SN-25x5-B-W2
	25	25 x 5,0	400	15	49,5	53,5	12,90	
	.98	.98 x .20	5800	.59	1.95	2.11	28.38	FI-SN-30x3-B-W2
30	30 x 3,0	160	24	52	57,5	11,55		
1.18	1.18 x .12	2320	.94	2.05	2.26	25.40	FI-SN-30x4-B-W2	
30	30 x 4,0	250	22	52	57,5	14,65		
1.18	1.18 x .16	3625	.87	2.05	2.26	32.23	FI-SN-30x5-B-W2	
30	30 x 5,0	315	20	52	57,5	16,91		
1.18	1.18 x .20	4568	.79	2.05	2.26	37.21	FI-SN-38x3-B-W2	
38	38 x 3,0	160	32	56,5	64,5	16,02		
1.50	1.50 x .12	2320	1.26	2.22	2.54	35.32	FI-SN-38x4-B-W2	
38	38 x 4,0	315	30	56,5	64,5	20,29		
1.50	1.50 x .16	4568	1.18	2.22	2.54	44.64	FI-SN-38x5-B-W2	
38	38 x 5,0	315	28	56,5	64,5	24,05		
1.50	1.50 x .20	4568	1.10	2.22	2.54	52.91	FI-SN-38x6-B-W2	
38	38 x 6,0	315	26	56,5	64,5	27,91		
1.50	1.50 x .24	4568	1.02	2.22	2.54	61.41		

<sup>1</sup> Approximate dimension in assembled condition.

<sup>2</sup> Weight excluding union nut.

<sup>3</sup> Standard scope of delivery: 24° weld cone and O-ring.

Standard seal material is NBR (Buna-N®).

**Ordering Codes**
**\*FI-SN\*-14x2\*-B\*-W2**

- \* 24° Weld Cone with O-Ring **FI-SN**
- \* Outside Tube Diameter (in mm) **-14**
- \* Wall Thickness (in mm) **x2**
- \* Seal Material NBR (Buna-N®) **-B**  
FKM (Viton®) **-V**  
EPDM **-E**
- \* Material Code Steel, phosphated **-W2**

Please contact STAUFF for alternative materials and surface finishings.

**\*FI-SN\*-14Sx2\*-B\*-W159\*-M**

- \* 24° Weld Cone with O-Ring **FI-SN**
- \* Outside Tube Diameter (in mm) **-14**
- \* Wall Thickness (in mm) **x2**
- \* Series Light Series (page 116) **L**  
Heavy Series (pages 117) **S**
- \* Seal Material NBR (Buna-N®) **-B**  
FKM (Viton®) **-V**  
EPDM **-E**
- \* Material Code Weld cone:  
Steel, phosphated **-W159**  
Union nut:  
Steel, zinc/nickel-plated

Please contact STAUFF for alternative materials and surface finishings.

- \* Assembling / Kitting 24° weld cone with O-ring supplied with union nut **-M**

**Connecting Parts**

 Union Nut  
Type **FI-M**

Page 33

**Spare Parts / Accessories**

 O-Ring  
Type **O-RING**

Page 239

**F**

## 24° Weld Cone Reducer with O-Ring Type FI-SNR • Series L / S

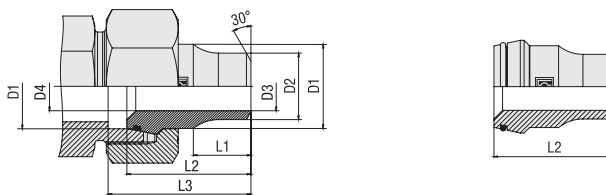

F

### Ordering Codes

#### \*FI-SNR\*-10/\*08\*x2.5\*-B\*-W2

- \* 24° Weld Cone Reducer with O-Ring **FI-SNR**
- \* Outside Tube Diameter D1 (in mm) **-10/**
- \* Outside Tube Diameter D2 (in mm) **-08**
- \* Wall Thickness (in mm) **x2.5**
- \* Seal Material **NBR (Buna-N®) -B**  
**FKM (Viton®) -V**  
**EPDM -E**
- \* Material Code **Steel, phosphated -W2**

Please contact STAUFF for alternative materials and surface finishings.

#### \*FI-SNR\*-10\*L/\*08\*x2.5\*-B\*-W159\*-M

- \* 24° Weld Cone Reducer with O-Ring **FI-SNR**
- \* Outside Tube Diameter D1 (in mm) **-10**
- \* Series **Light Series L**  
**Heavy Series S**
- \* Outside Tube Diameter D2 (in mm) **-08**
- \* Wall Thickness (in mm) **x2.5**
- \* Seal Material **NBR (Buna-N®) -B**  
**FKM (Viton®) -V**  
**EPDM -E**
- \* Material Code **Weld cone: -W159**  
**Steel, phosphated**  
**Union nut:**  
**Steel, zinc/nickel-plated**

Please contact STAUFF for alternative materials and surface finishings.

- \* Assembling / Kitting **24° weld cone with O-ring supplied with union nut -M**

Series	Tube OD		PN (bar/psi)	Dimensions (mm/in)						Weight (%/lbs) ca. per 100	Ordering Codes <sup>3</sup>
	D1	for Tube		D2	D3	D4	L1	L2	L3		
L/S	8	6 x 2,0	400	6	2	5	12	31	32	1,45	FI-SNR-08/06x2-B-W2
	.31	.24 x .08	5800	.24	.08	.20	.47	1.22	1.26	3.19	
	10	8 x 2,5	400	8	3	6,50	12	32,5	33,5	1,75	FI-SNR-10/08x2.5-B-W2
	.39	.31 x .10	5800	.31	.12	.26	.47	1.28	1.32	3.85	
	12	10 x 3,0	400	10	4	8	14	32,5	33,5	2,19	FI-SNR-12/10x3-B-W2
.47	.39 x .12	5800	.39	.16	.31	.55	1.28	1.32	4.82		
S	14	12 x 3,5	400	12	5	9	15	38,5	39,5	3,56	FI-SNR-14/12x3.5-B-W2
	.55	.47 x .14	5800	.47	.20	.35	.59	1.52	1.56	7.83	
	16	12 x 2,0	250	12	8	11	17	38,5	41	4,70	FI-SNR-16/12x2-B-W2
	.63	.47 x .08	3625	.47	.31	.43	.67	1.52	1.61	10.34	
	20	12 x 3,5	400	12	5	14	17	44,5	47	8,55	FI-SNR-20/12x3.5-B-W2
	.79	.47 x .14	5800	.47	.20	.55	.67	1.75	1.85	18.85	
	20	16 x 2,0	315	16	12	14	17	44,5	47	6,65	FI-SNR-20/16x2-B-W2
	.79	.63 x .08	4568	.63	.47	.55	.67	1.75	1.85	14.66	
	20	16 x 3,0	315	16	10	14	17	44,5	47	7,73	FI-SNR-20/16x3-B-W2
	.79	.63 x .12	4568	.63	.39	.55	.67	1.75	1.85	17.01	
	25	16 x 2,0	315	16	12	18	20	49,5	53	11,72	FI-SNR-25/16x2-B-W2
	.98	.63 x .08	4568	.63	.47	.71	.79	1.95	2.09	25.84	
	25	16 x 3,0	315	16	10	18	20	49,5	53	12,96	FI-SNR-25/16x3-B-W2
	.98	.63 x .12	4568	.63	.39	.71	.79	1.95	2.09	28.57	
	25	20 x 2,0	160	20	16	18	20	49,5	53	11,72	FI-SNR-25/20x2-B-W2
	.98	.79 x .08	2320	.79	.63	.71	.79	1.95	2.09	21.94	
	25	20 x 4,0	400	20	12	18	20	49,5	53	12,82	FI-SNR-25/20x4-B-W2
	.98	.79 x .16	5800	.79	.47	.71	.79	1.95	2.09	28.26	
	30	16 x 3,0	315	16	10	22	22	52	57,5	19,04	FI-SNR-30/16x3-B-W2
	1.18	.63 x .12	4568	.63	.39	.87	.87	2.05	2.26	41.98	
	30	20 x 4,0	315	20	12	22	22	52	57,5	19,31	FI-SNR-30/20x4-B-W2
	1.18	.79 x .16	4568	.79	.47	.87	.87	2.05	2.26	42.57	
	30	25 x 5,0	315	25	15	22	22	52	57,5	16,91	FI-SNR-30/25x5-B-W2
	1.18	.98 x .20	4568	.98	.59	.87	.87	2.05	2.26	37.21	
	38	16 x 3,0	315	16	10	30	26	56	62	29,79	FI-SNR-38/16x3-B-W2
1.50	.63 x .12	4568	.63	.39	1.18	1.02	2.20	2.44	65.68		
38	20 x 4,0	315	20	12	30	26	56	62	30,32	FI-SNR-38/20x4-B-W2	
1.50	.79 x .16	4568	.79	.47	1.18	1.02	2.20	2.44	66.84		
38	25 x 5,0	315	25	15	30	26	56	62	30,95	FI-SNR-38/25x5-B-W2	
1.50	.98 x .20	4568	.98	.59	1.18	1.02	2.20	2.44	68.23		
38	30 x 4,0	315	30	22	30	26	56	62	26,36	FI-SNR-38/30x4-B-W2	
1.50	1.18 x .16	4568	1.18	.87	1.18	1.02	2.20	2.44	58.11		

<sup>1</sup> Approximate dimension in assembled condition.

<sup>2</sup> Weight excluding union nut.

<sup>3</sup> Standard scope of delivery: 24° weld cone and O-ring.

Standard seal material is NBR (Buna-N®).

### Connecting Parts



Union Nut  
Type FI-M

Page 33

### Spare Parts / Accessories



O-Ring  
Type O-RING

Page 239



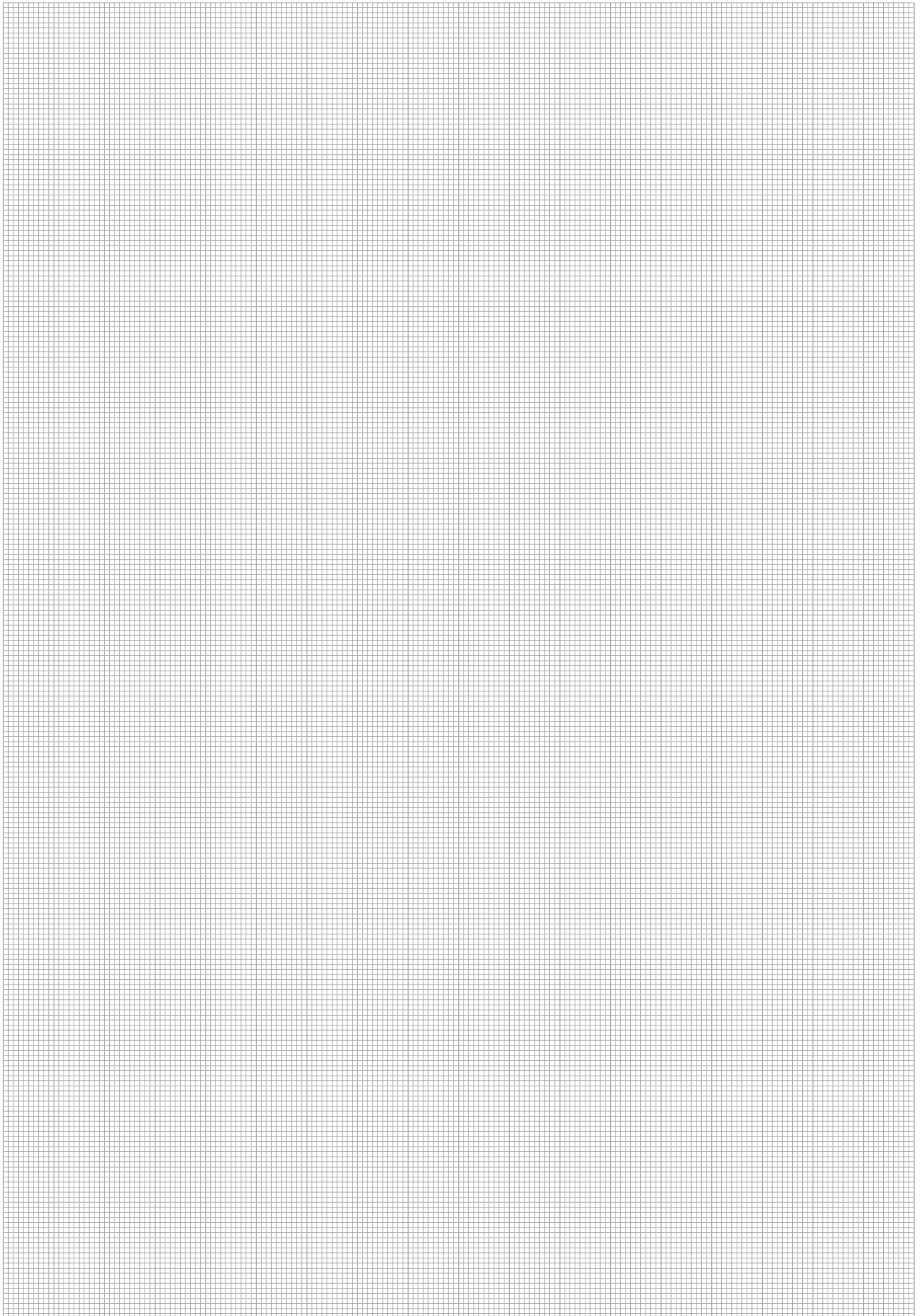

### Straight Weld Fitting for Tubes Type FI-ASV • Series S

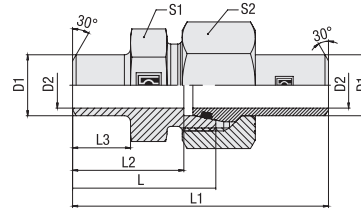

F

#### Ordering Codes

**\*FI-ASV\*-06\*S\*x1.5\*-B\*-W159\*-MSN**

- \* Straight Weld Fitting for Tubes **FI-ASV**
  - \* Outside Tube Diameter (in mm) **-06**
  - \* Series Heavy Series **S**
  - \* Wall Thickness (in mm) **x1.5**
  - \* Seal Material NBR (Buna-N®) **-B**  
FKM (Viton®) **-V**  
EPDM **-E**
  - \* Material Code Steel, phosphated **-W2**  
Fitting body / weld cone: Steel, phosphated **-W159**  
Union nut: Steel, zinc/nickel-plated
- Please contact STAUFF for alternative materials and surface finishings.
- \* Assembling / Kitting Straight weld fitting for tubes supplied with 24° weld cone with O-ring and union nut **-MSN**

#### Connecting Parts



Union Nut  
Type **FI-M**

Page 33

#### Spare Parts / Accessories



O-Ring  
Type **O-RING**

Page 239

Series	Tube OD		PN (bar/psi)	Dimensions							Weight (kg/lbs) ca. per 100	Ordering Codes <sup>3</sup>
	D1	for Tube		D2	L	L1 <sup>1</sup>	L2	L3	S1	S2		
S	10	10 x 1,0	249	8	32	58	24,5	10	19	22	8,11	FI-ASV-10Sx1-B-W159-MSN
	.39	.39 x .04	3610	.31	1.26	2.28	.96	.39	.75	.87	17.84	
	10	10 x 1,5	358	7	32	58	24,5	10	19	22	8,54	FI-ASV-10Sx1.5-B-W159-MSN
	.39	.39 x .06	5191	.28	1.26	2.28	.96	.39	.75	.87	18.79	
	10	10 x 2,0	460	6	32	58	24,5	10	19	22	8,99	FI-ASV-10Sx2-B-W159-MSN
	.39	.39 x .08	6670	.24	1.26	2.28	.96	.39	.75	.87	19.78	
	12	12 x 1,5	305	9	37	63	29,5	15	22	24	10,47	FI-ASV-12Sx1.5-B-W159-MSN
	.47	.47 x .06	4423	.35	1.46	2.48	1.16	.59	.87	.94	23.03	
	12	12 x 2,0	393	8	37	63	29,5	15	22	24	11,00	FI-ASV-12Sx2-B-W159-MSN
	.47	.47 x .08	5699	.31	1.46	2.48	1.16	.59	.87	.94	24.20	
	12	12 x 2,5	476	7	37	63	29,5	15	22	24	11,54	FI-ASV-12Sx2.5-B-W159-MSN
	.47	.47 x .10	6902	.28	1.46	2.48	1.16	.59	.87	.94	25.39	
	16	16 x 1,5	234	13	41,5	74	33	16,5	27	30	17,40	FI-ASV-16Sx1.5-B-W159-MSN
	.63	.63 x .06	3393	.51	1.63	2.91	1.30	.65	1.06	1.18	38.28	
	16	16 x 2,0	305	12	41,5	74	33	16,5	27	30	18,30	FI-ASV-16Sx2-B-W159-MSN
	.63	.63 x .08	4423	.47	1.63	2.91	1.30	.65	1.06	1.18	40.26	
	16	16 x 2,5	372	11	41,5	74	33	16,5	27	30	19,27	FI-ASV-16Sx2.5-B-W159-MSN
	.63	.63 x .10	5394	.43	1.63	2.91	1.30	.65	1.06	1.18	42.39	
	16	16 x 3,0	400	10	41,5	74	33	16,5	27	30	20,09	FI-ASV-16Sx3-B-W159-MSN
	.63	.63 x .12	5800	.39	1.63	2.91	1.30	.65	1.06	1.18	44.20	
	20	20 x 2,0	249	16	47	84	36,5	19	32	36	28,18	FI-ASV-20Sx2-B-W159-MSN
	.79	.79 x .08	3611	.63	1.85	3.31	1.44	.75	1.26	1.42	62.00	
	20	20 x 2,5	305	15	47	84	36,5	19	32	36	29,67	FI-ASV-20Sx2.5-B-W159-MSN
	.79	.79 x .10	4423	.59	1.85	3.31	1.44	.75	1.26	1.42	65.27	
	20	20 x 3,0	358	14	47	84	36,5	19	32	36	31,08	FI-ASV-20Sx3-B-W159-MSN
	.79	.79 x .12	5191	.55	1.85	3.31	1.44	.75	1.26	1.42	68.38	
	20	20 x 4,0	400	12	47	84	36,5	19	32	36	33,10	FI-ASV-20Sx4-B-W159-MSN
	.79	.79 x .16	5800	.47	1.85	3.31	1.44	.75	1.26	1.42	72.82	
	25	25 x 3,0	294	19	51,5	93	39,5	19,5	41	46	53,44	FI-ASV-25Sx3-B-W159-MSN
	.98	.98 x .12	4263	.75	2.03	3.66	1.56	.77	1.61	1.81	117.57	
	25	25 x 4,0	379	17	51,5	93	39,5	19,5	41	46	57,29	FI-ASV-25Sx4-B-W159-MSN
	.98	.98 x .16	5496	.67	2.03	3.66	1.56	.77	1.61	1.81	126.04	
	25	25 x 5,0	400	15	51,5	93	39,5	19,5	41	46	59,90	FI-ASV-25Sx5-B-W159-MSN
	.98	.98 x .20	5800	.59	2.03	3.66	1.56	.77	1.61	1.81	131.78	
30	30 x 3,0	249	24	58	102	44,5	23	46	50	66,38	FI-ASV-30Sx3-B-W159-MSN	
1.18	1.18 x .12	3611	.94	2.28	4.02	1.75	.91	1.81	1.97	146.04		
30	30 x 4,0	323	22	58	102	44,5	23	46	50	71,62	FI-ASV-30Sx4-B-W159-MSN	
1.18	1.18 x .16	4684	.87	2.28	4.02	1.75	.91	1.81	1.97	157.56		
30	30 x 5,0	393	20	58	102	44,5	23	46	50	75,33	FI-ASV-30Sx5-B-W159-MSN	
1.18	1.18 x .20	5699	.79	2.28	4.02	1.75	.91	1.81	1.97	165.73		
30	30 x 6,0	400	18	58	102	44,5	23	46	50	79,03	FI-ASV-30Sx6-B-W159-MSN	
1.18	1.18 x .24	5800	.71	2.28	4.02	1.75	.91	1.81	1.97	173.87		
38	38 x 4,0	261	30	60	109	44	22	55	60	102,93	FI-ASV-38Sx4-B-W159-MSN	
1.50	1.50 x .16	3785	1.18	2.36	4.29	1.73	.87	2.17	2.36	226.45		
38	38 x 5,0	315	28	60	109	44	22	55	60	108,61	FI-ASV-38Sx5-B-W159-MSN	
1.50	1.50 x .20	4568	1.10	2.36	4.29	1.73	.87	2.17	2.36	238.94		
38	38 x 6,0	315	26	60	109	44	22	55	60	114,48	FI-ASV-38Sx6-B-W159-MSN	
1.50	1.50 x .24	4568	1.02	2.36	4.29	1.73	.87	2.17	2.36	251.86		
38	38 x 7,0	315	24	60	109	44	22	55	60	119,83	FI-ASV-38Sx7-B-W159-MSN	
1.50	1.50 x .28	4568	.94	2.36	4.29	1.73	.87	2.17	2.36	263.63		

<sup>1</sup> Approximate dimension in assembled condition.

<sup>2</sup> Weight including 24° weld cone and union nut.

<sup>3</sup> Standard scope of delivery:

24° weld cone, O-ring and union nut.





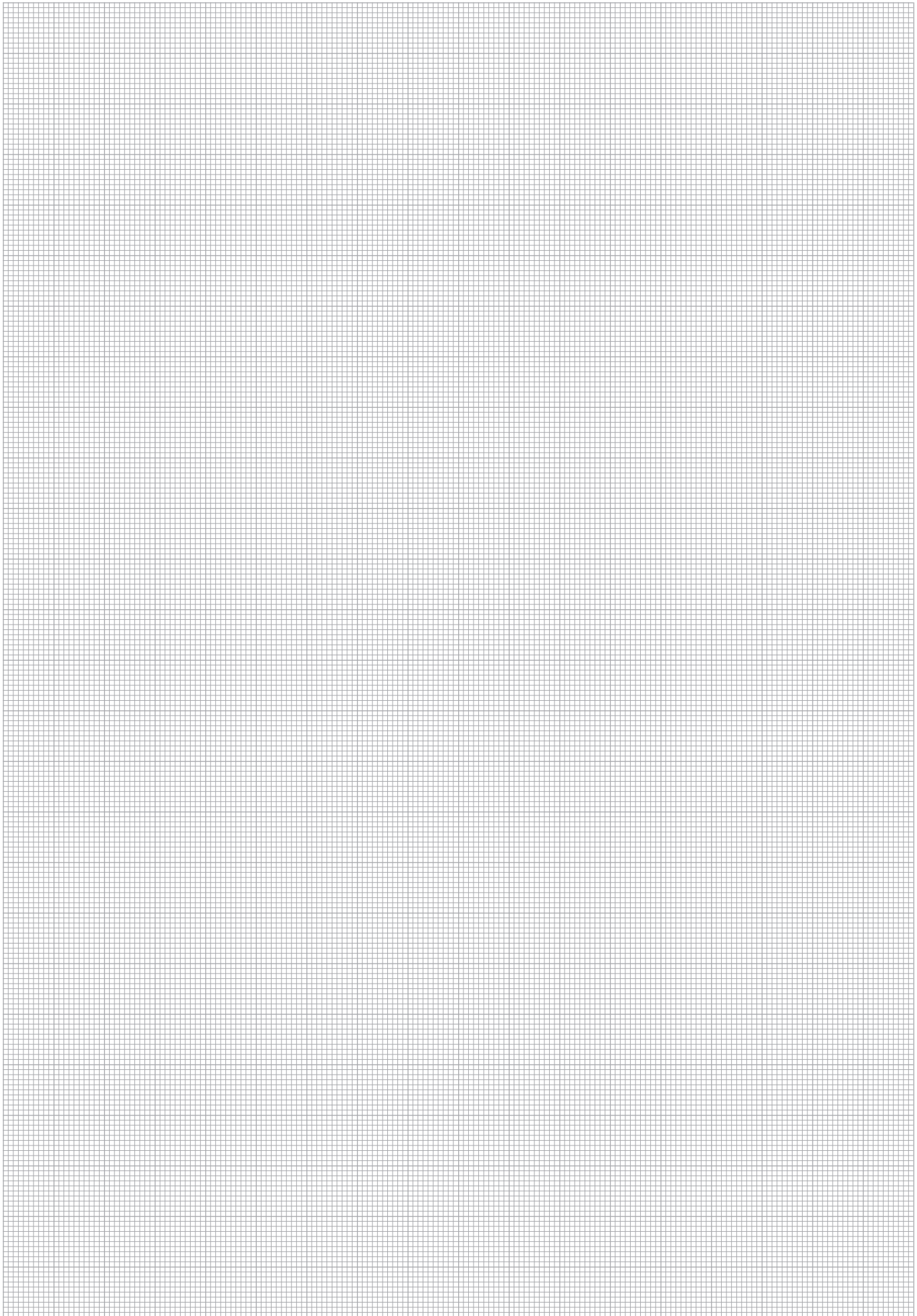

Standard seal material is NBR (Buna-N®).









	<b>Straight Female Stud Fitting</b>	124-127
	FI-GA	
	<b>Female Whitworth Parallel Pipe Thread (BSPP)</b>	124
	FI-GA-...-R	
	<b>Female Metric Parallel Thread</b>	126
	FI-GA-...-M	
	<b>Female NPT Thread</b>	127
	FI-GA-...-N	
	<b>Gauge Fitting</b>	129
	FI-MA	
	<b>Female Whitworth Parallel Pipe Thread (BSPP) / Internal Metallic Sealing Ring</b>	129
	FI-MA-...-R	
	<b>Gauge Fitting with 24° Taper / O-Ring</b>	130
	FI-EMAD	
	<b>Female Whitworth Parallel Pipe Thread (BSPP) / Internal Metallic Sealing Ring</b>	130
	FI-EMAD-...-R	
	<b>Gauge Standpipe Fitting</b>	131
	FI-EMA	
	<b>Female Whitworth Parallel Pipe Thread (BSPP) / Internal Metallic Sealing Ring</b>	131
	FI-EMA-...-R	



**Straight Female Stud Fitting**  
Type FI-GA-...-R ■ Series L

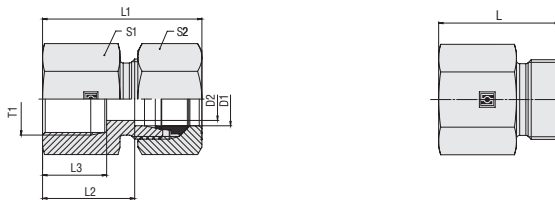

**Female Whitworth Parallel Pipe Thread (BSPP)**

**Ordering Codes**

**\*FI-GA\*-10\*L\*R\*-W3\*-MS**

- \* Straight Female Stud Fitting **FI-GA**
- \* Outside Tube Diameter D1 (in mm) **-10**
- \* Series **L**  
Light Series (page 124)  
Heavy Series (page 125) **S**
- \* Thread Type **R**  
Female Whitworth Parallel  
Pipe Thread (BSPP)
- If required, please indicate special sizes, e.g. R3/8!
- \* Material Code **-W3**  
Steel, zinc/nickel-plated
- Please contact STAUFF for alternative  
materials and surface finishings.
- \* Assembling / Kitting **—**  
Fitting body only
- Fitting body supplied with  
cutting ring and union nut **-MS**
- Fitting body supplied with  
soft-sealing cutting ring  
and union nut **-MSV**

**Connecting Parts**

-  Cutting Ring  
Type **FI-DS** Page 28
-  Soft-Sealing Cutting Ring  
Type **FI-WDDS** Page 29
-  Support Sleeve  
Type **FI-VH** Page 31
-  STAUFF Form EVO Sealing Ring  
Type **FI-FD** Page 32
-  Union Nut  
Type **FI-M** Page 33
-  37° Flared Tube Fitting Set  
Type **FI-AB** Page 37

Series	Tube OD		PN	Dimensions								Weight (kg/lbs) ca. per 100	Ordering Codes <sup>3</sup>
	(mm/in)	(mm/in)		(bar/PSI)	(mm/in)	Thread T	D2	L	L1 <sup>1</sup>	L2	L3		
L	6	315		G 1/8	4	26	34	19	12	14	14	3,26	FI-GA-06LR-W3
	.24	4568			.16	1.02	1.34	.75	.47	.55	.55	7.16	
6	6	315		G 1/4	4	31	39	24	18	19	14	3,78	FI-GA-06LR1/4-W3
	.24	4568			.16	1.22	1.54	.94	.71	.75	.55	8.32	
6	6	315		G3/8	6	26	34	19	12	14	17	5,88	FI-GA-06LR3/8-W3
	.24	4568			.24	1.02	1.34	.75	.47	.55	.67	12.96	
8	8	315		G 1/8	6	26	34	19	12	14	17	1,95	FI-GA-08LR1/8-W3
	.31	4568			.24	1.02	1.34	.75	.47	.55	.67	4.30	
8	8	315		G 1/4	6	31	39	24	17	19	17	3,91	FI-GA-08LR-W3
	.31	4568			.24	1.22	1.54	.94	.67	.75	.67	8.61	
8	8	315		G 3/8	6	31	39	24	16	24	17	2,28	FI-GA-08LR3/8-W3
	.31	4568			.24	1.22	1.54	.94	.63	.94	.67	5.02	
8	8	315		G 1/2	6	36	44	29	20	27	17	8,35	FI-GA-08LR1/2-W3
	.31	4568			.24	1.42	1.73	1.14	.79	1.06	.67	18.37	
10	10	315		G 1/4	8	32	40	25	17	19	19	3,95	FI-GA-10LR-W3
	.39	4568			.31	1.26	1.57	.98	.67	.75	.75	8.69	
10	10	315		G 3/8	8	32	40	25	16	24	19	4,94	FI-GA-10LR3/8-W3
	.39	4568			.31	1.26	1.57	.98	.63	.94	.75	10.86	
10	10	315		G 1/2	8	37	45	30	20	27	19	8,36	FI-GA-10LR1/2-W3
	.39	4568			.31	1.46	1.77	1.18	.79	1.06	.75	18.39	
12	12	315		G 1/4	8	33	41	26	17	19	22	4,44	FI-GA-12LR1/4-W3
	.47	4568			.31	1.3	1.61	1.02	.67	.75	.87	9.76	
12	12	315		G 3/8	10	33	41	26	17	24	22	6,43	FI-GA-12LR-W3
	.47	4568			.39	1.3	1.61	1.02	.67	.94	.87	14.14	
12	12	315		G 1/2	10	37	45	30	20	27	22	8,38	FI-GA-12LR1/2-W3
	.47	4568			.39	1.46	1.77	1.18	.79	1.06	.87	18.44	
15	15	315		G 3/8	12	34	43	27	17	24	27	6,95	FI-GA-15LR3/8-W3
	.59	4568			0.47	1.34	1.69	1.06	0.67	0.94	1.06	15.32	
15	15	315		G 1/2	12	38	46	31	20	27	27	8,84	FI-GA-15LR-W3
	.59	4568			.47	1.50	1.81	1.22	.79	1.06	1.06	19.46	
15	15	315		G 3/4	12	38	46	31	20	30	27	19,13	FI-GA-15LR3/4-W3
	.59	4568			.47	1.5	1.81	1.22	.79	1.18	1.06	42.17	
18	18	315		G 3/8	15	34	43	26,5	20	27	32	9,61	FI-GA-18LR3/8-W3
	.71	4568			.59	1.34	1.69	1.04	.79	1.06	1.26	21.15	
18	18	315		G 1/2	15	38	47	30,5	20	27	32	9,15	FI-GA-18LR-W3
	.71	4568			.59	1.50	1.85	1.20	.79	1.06	1.26	20.14	
22	22	160		G 1/2	18,5	39	48,5	31,5	15,5	32	36	14,1	FI-GA-22LR1/2-W3
	.87	2320			.73	1.54	1.91	1.24	.61	1.26	1.42	31.09	
22	22	160		G 3/4	19	43	52	35,5	22	36	36	17,87	FI-GA-22LR-W3
	.87	2320			.75	1.69	2.05	1.40	.87	1.42	1.42	39.31	
22	22	160		G1	19	45,5	54,5	38	24,5	41	36	21,68	FI-GA-22LR1-W3
	.87	2320			.75	1.79	2.15	1.5	.96	1.61	1.42	47.80	
28	28	160		G 1	24	45,5	54,5	38	24,5	41	41	21,80	FI-GA-28LR-W3
	1.1	2320			.94	1.79	2.15	1.50	.96	1.61	1.61	47.96	
35	35	160		G 1 1/4	30	51,5	62,5	41	26,5	55	50	47,49	FI-GA-35LR-W3
	1.38	2320			1.18	2.03	2.46	1.61	1.04	2.17	1.97	104.47	
42	42	160		G 1 1/4	36	53,5	67	42,5	26,5	55	60	48,83	FI-GA-42LR1-1/4-W3
	1.65	2320			1.42	2.11	2.64	1.67	1.04	2.17	2.36	107.65	
42	42	160		G 1 1/2	36	53,5	65,5	42,5	28,5	60	60	53,90	FI-GA-42LR-W3
	1.65	2320			1.42	2.11	2.58	1.67	1.12	2.36	2.36	118.58	

<sup>1</sup> Approximate dimension in assembled condition.

<sup>2</sup> Weight excluding cutting ring and union nut.

<sup>3</sup> Standard scope of delivery: Fitting body only.



Straight Female Stud Fitting  
Type FI-GA-...-R • Series S

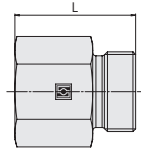
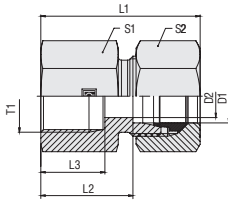

Female Whitworth Parallel Pipe Thread (BSPP)

Series	Tube OD (mm/in)	PN (bar/PSI)	Dimensions (mm/in)								Weight (kg/lbs) ca. per 100	Ordering Codes <sup>3</sup>
			Thread T	D2	L	L1 <sup>1</sup>	L2	L3	S1	S2		
S	6	630	G 1/4	4	33	41	26	17	19	17	4,33	FI-GA-06SR-W3
	.24	9135		.16	1.3	1.61	1.02	.67	.75	.67	9,52	
8	630	630	G 1/4	5	33	41	26	17	19	19	4,53	FI-GA-08SR-W3
	.31	9135		.2	1.30	1.61	1.02	.67	.75	.75	9,96	
8	630	630	G 3/8	5	34	41,5	26,5	17	24	19	7	FI-GA-08SR3/8-W3
	.31	9135		.2	1.34	1.63	1.04	.67	.94	.75	15,43	
10	630	630	G 1/4	7	33	43,5	25,5	17	19	22	4,68	FI-GA-10SR1/4-W3
	.39	9135		.28	1.3	1.71	1.00	.67	.75	.87	10,32	
10	630	630	G 3/8	7	34	43	26,5	17	24	22	6,99	FI-GA-10SR-W3
	.39	9135		.28	1.34	1.69	1.04	.67	.94	.87	15,37	
12	630	630	G 1/4	8	33	43,5	25,5	17	22	24	6,58	FI-GA-12SR1/4-W3
	.47	9135		.31	1.3	1.71	1.00	.67	.87	.94	14,51	
12	630	630	G 3/8	8	34	43	26,5	17	24	24	7,08	FI-GA-12SR-W3
	.47	9135		.31	1.34	1.69	1.04	.67	.94	.94	15,57	
12	630	630	G 1/2	8	38	47	30,5	20	27	24	9,23	FI-GA-12SR1/2-W3
	.47	9135		.31	1.50	1.85	1.20	.79	1.06	.94	20,31	
14	630	630	G 1/2	10	40	50	32	20	27	27	9,64	FI-GA-14SR-W3
	.55	9135		.39	1.57	1.97	1.26	.79	1.06	1.06	21,20	
16	630	630	G 3/8	12	36	52	27,5	17	24	30	7,77	FI-GA-16SR3/8-W3
	.63	9135		.47	1.42	2.05	1.08	.67	.94	1.18	12,13	
16	630	630	G 1/2	12	40	50	31,5	20	27	30	9,70	FI-GA-16SR-W3
	.63	9135		.47	1.57	1.97	1.24	.79	1.06	1.18	21,33	
20	400	400	G 3/4	16	45	56	34,5	22	36	36	19,50	FI-GA-20SR-W3
	.79	5800		.63	1.77	2.20	1.36	.87	1.42	1.42	42,90	
25	400	400	G 3/4	20	47	59	35	22	41	46	28,74	FI-GA-25SR3/4-W3
	.98	5800		.79	1.85	2.32	1.38	.87	1.61	1.81	63,36	
25	400	400	G 1	20	49,5	61,5	37,5	24,5	41	46	25,14	FI-GA-25SR-W3
	.98	5800		.79	1.95	2.42	1.48	.96	1.61	1.81	55,30	
30	400	400	G 1 1/4	25	55,5	68,5	42	26,5	55	50	51,30	FI-GA-30SR-W3
	1.18	5800		.98	2.19	2.70	1.65	1.04	2.17	1.97	112,86	
38	315	315	G 1 1/2	32	59,5	74,5	43,5	28,5	60	60	62,80	FI-GA-38SR-W3
	1.50	4568		1.26	2.34	2.93	1.71	1.12	2.36	2.36	138,16	

<sup>1</sup> Approximate dimension in assembled condition.

<sup>2</sup> Weight excluding cutting ring and union nut.

<sup>3</sup> Standard scope of delivery: Fitting body only.

Ordering Codes

**\*FI-GA\*-10\*S\*R\*-W3\*-MS**

* Straight Female Stud Fitting	FI-GA
* Outside Tube Diameter D1 (in mm)	-10
* Series	Light Series (page 124) L Heavy Series (page 125) S
* Thread Type	Female Whitworth Parallel Pipe Thread (BSPP) R
If required, please indicate special sizes, e.g. R3/8!	
* Material Code	Steel, zinc/nickel-plated -W3
Please contact STAUFF for alternative materials and surface finishings.	
* Assembling / Kitting	Fitting body only —
	Fitting body supplied with cutting ring and union nut -MS
	Fitting body supplied with soft-sealing cutting ring and union nut -MSV

Connecting Parts

	Cutting Ring Type FI-DS	Page 28
	Soft-Sealing Cutting Ring Type FI-WDDS	Page 29
	Support Sleeve Type FI-VH	Page 31
	STAUFF Form EVO Sealing Ring Type FI-FD	Page 32
	Union Nut Type FI-M	Page 33
	37° Flared Tube Fitting Set Type FI-AB	Page 37



**Straight Female Stud Fitting**  
Type FI-GA-...-M ▪ Series L / S

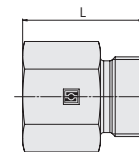
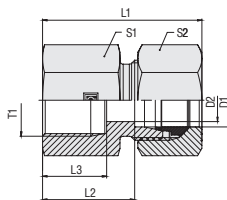

**Female Metric Parallel Thread**

**Ordering Codes**

**\*FI-GA\*-10\*L\*M\*-W3\*-MS**

- \* Straight Female Stud Fitting **FI-GA**
- \* Outside Tube Diameter D1 (in mm) **-10**
- \* Series **L**  
Light Series  
Heavy Series **S**
- \* Thread Type **M**  
Female Metric Parallel Thread
- If required, please indicate special sizes, e.g. M12x1.5!
- \* Material Code **-W3**  
Steel, zinc/nickel-plated
- Please contact STAUFF for alternative materials and surface finishings.
- \* Assembling / Kitting **—**  
Fitting body only
- Fitting body supplied with cutting ring and union nut **-MS**
- Fitting body supplied with soft-sealing cutting ring and union nut **-MSV**

**Connecting Parts**

- Cutting Ring  
Type **FI-DS** Page 28
- Soft-Sealing Cutting Ring  
Type **FI-WDDS** Page 29
- Support Sleeve  
Type **FI-VH** Page 31
- STAUFF Form EVO Sealing Ring  
Type **FI-FD** Page 32
- Union Nut  
Type **FI-M** Page 33
- 37° Flared Tube Fitting Set  
Type **FI-AB** Page 37

Series	Tube OD		PN	Dimensions								Weight ( <sup>kg</sup> / <sub>lbs</sub> ) ca. per 100	Ordering Codes <sup>3</sup>
	(mm/in)	(bar/psi)		(mm/in)	Thread	T	D2	L	L1 <sup>1</sup>	L2	L3		
L	6	315	4568	M10 x 1	4	26,5	34,5	19,5	12,5	14	14	1,89	FI-GA-06LM-W3
	.24				.16	1.04	1.36	.77	.49	.55	.55	4.15	
	8	315	4568	M12 x 1,5	6	31	39	24	17	17	17	3,40	FI-GA-08LM-W3
	.31				.24	1.22	1.54	.94	.67	.67	.67	7.48	
	10	315	4568	M14 x 1,5	8	32	40	25	17	19	19	3,73	FI-GA-10LM-W3
	.39				.31	1.26	1.57	.98	.67	.75	.75	8.20	
	12	315	4568	M16 x 1,5	10	33	41	26	17	22	22	5,29	FI-GA-12LM-W3
	.47				.39	1.30	1.61	1.02	.67	.87	.87	11.64	
	12	315	4568	M18 x 1,5	10	33	42,5	26	17	24	22	6	FI-GA-12LM18x1.5-W3
	.47				.39	1.3	1.67	1.02	.67	.94	.87	13.23	
	15	315	4568	M18 x 1,5	12	35	43	28	17	24	27	6,77	FI-GA-15LM-W3
	.59				.47	1.38	1.69	1.10	.67	.94	1.06	14.89	
	18	315	4568	M22 x 1,5	15	37	46	29,5	19	30	32	11,20	FI-GA-18LM-W3
	.71				.59	1.46	1.81	1.16	.75	1.18	1.26	24.63	
	22	160	2320	M26 x 1,5	19	42	51	34,5	21	32	36	12,42	FI-GA-22LM-W3
	.87				.75	1.65	2.01	1.36	.83	1.26	1.42	27.33	
	28	160	2320	M33 x 2	24	45	54	37,5	24	41	41	21,35	FI-GA-28LM-W3
	1.10				.94	1.77	2.13	1.48	.94	1.61	1.61	46.97	
35	160	2320	M42 x 2	30	51	62	40,5	26	55	50	46,20	FI-GA-35LM-W3	
1.38				1.18	2.01	2.44	1.59	1.02	2.17	1.97	101.64		
42	160	2320	M48 x 2	36	53	65	42	28	60	60	52,10	FI-GA-42LM-W3	
1.65				1.42	2.09	2.56	1.65	1.10	2.36	2.36	114.62		
S	6	630	9135	M12 x 1,5	4	33	41,5	26	17	17	3,49	FI-GA-06SM-W3	
	.24				.16	1.3	1.63	1.02	.67	.67	.67		7.69
	8	630	9135	M14 x 1,5	5	33	41	26	17	19	4,36	FI-GA-08SM-W3	
	.31				.20	1.30	1.61	1.02	.67	.75	.75		9.59
	10	630	9135	M16 x 1,5	7	34	43	26,5	17	22	22	1,31	FI-GA-10SM-W3
	.39				.28	1.34	1.69	1.04	.67	.87	.87	2.89	
	12	630	9135	M18 x 1,5	8	35	44	27,5	17	24	24	7,01	FI-GA-12SM-W3
	.47				.31	1.38	1.73	1.08	.67	.94	.94	15.41	
	14	630	9135	M20 x 1,5	10	39	49	31	19	27	27	9,54	FI-GA-14SM-W3
	.55				.39	1.54	1.93	1.22	.75	1.06	1.06	20.99	
	16	630	9135	M22 x 1,5	12	39	49	30,5	19	30	30	11,71	FI-GA-16SM-W3
	.63				.47	1.54	1.93	1.20	.75	1.18	1.18	25.76	
	20	400	5800	M27 x 2	16	45	56	34,5	22	36	36	18,68	FI-GA-20SM-W3
	.79				.63	1.77	2.20	1.36	.87	1.42	1.42	41.09	
	25	400	5800	M33 x 2	20	49	61	37	24	41	46	24,73	FI-GA-25SM-W3
	.98				.79	1.93	2.40	1.46	.94	1.61	1.81	54.40	
	30	400	5800	M42 x 2	25	55	68	41,5	26	55	50	50,30	FI-GA-30SM-W3
	1.18				.98	2.17	2.68	1.63	1.02	2.17	1.97	110.66	
38	400	5800	M48 x 2	32	59	74	43	28	60	60	62,80	FI-GA-38SM-W3	
1.50				1.26	2.32	2.91	1.69	1.10	2.36	2.36	138.16		

<sup>1</sup> Approximate dimension in assembled condition.

<sup>2</sup> Weight excluding cutting ring and union nut.

<sup>3</sup> Standard scope of delivery: Fitting body only.



**Straight Female Stud Fitting**  
Type FI-GA-...-N • Series L / S

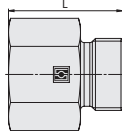
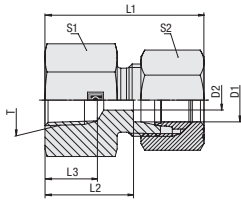

NPT Thread

Series	Tube OD (mm/in)	PN (bar/PSI)	Dimensions (mm/in)									Weight (kg/lbs) ca. per 100	Ordering Codes <sup>3</sup>
			Thread T	D2	L	L1 <sup>1</sup>	L2	L3	S1	S2			
L	6	315	1/4 NPT	4	30,5	38	23,5	16,4	19	14	4,20	FI-GA-06L1/4N-W3	
	.24	4568		.16	1.20	1.50	.93	.65	.75	.55	9.24		
	8	315	1/4 NPT	6	30,5	38	23,5	16,4	19	17	4,30	FI-GA-08L1/4N-W3	
	.31	4568		.24	1.20	1.50	.93	.65	.75	.67	9.46		
	10	315	1/4 NPT	8	31	39	24,0	16,4	19	19	4,10	FI-GA-10L1/4N-W3	
	.39	4568		.31	1.22	1.54	.95	.65	.75	.75	9.02		
	12	315	3/8 NPT	10	34	42	27	20,8	24	22	6,6	FI-GA-12L3/8N-W3	
	.47	4568		.39	1.34	1.65	1.06	.82	.94	.87	14.55		
	18	315	1/2 NPT	15	40	49	32	28,5	27	32	9,71	FI-GA-18L1/2N-W3	
.71	4568		.59	1.57	1.93	1.26	1.12	1.06	1.26	21.41			
S	14	400	1/2 NPT	10	43	49	35	26	27	27	9,58	FI-GA-14S1/2N-W3	
	.55	5800		.39	1.69	1.93	1.38	1.02	1.06	1.06	21.12		
	16	400	1/2 NPT	12	43	50	34,5	22,6	27	30	11,70	FI-GA-16S1/2N-W3	
	.63	5800		.47	1.69	1.97	1.36	.89	1.06	1.18	25.74		
	20	315	1/2 NPT	16	44	55	33,5	23,1	32	36	16,00	FI-GA-20S1/2N-W3	
	.79	4568		.63	1.73	2.17	1.32	.91	1.26	1.42	35.20		
	20	315	3/4 NPT	16	46	57	35,5	23,1	36	36	20,29	FI-GA-20S3/4N-W3	
.79	4568		.63	1.81	2.24	1.40	.91	1.42	1.42	44.63			

<sup>1</sup> Approximate dimension in assembled condition.

<sup>2</sup> Weight excluding cutting ring and union nut.

<sup>3</sup> Standard scope of delivery: Fitting body only.

**Ordering Codes**

**\*FI-GA\*-10\*L\*1/4\*N\*-W3\*-MS**

* Straight Female Stud Fitting	FI-GA
* Outside Tube Diameter D1 (in mm)	-10
* Series	Light Series L Heavy Series S
* Thread Size	acc. to dimension table 1/4
Please always indicate thread sizes, e.g. 1/4!	
* Thread Type	NPT Thread N
* Material Code	Steel, zinc/nickel-plated -W3
Please contact STAUFF for alternative materials and surface finishings.	
* Assembling / Kitting	Fitting body only —
	Fitting body supplied with cutting ring and union nut -MS
	Fitting body supplied with soft-sealing cutting ring and union nut -MSV

**Connecting Parts**

	Cutting Ring Type FI-DS	Page 28
	Soft-Sealing Cutting Ring Type FI-WDDS	Page 29
	Support Sleeve Type FI-VH	Page 31
	STAUFF Form EVO Sealing Ring Type FI-FD	Page 32
	Union Nut Type FI-M	Page 33
	37° Flared Tube Fitting Set Type FI-AB	Page 37



G

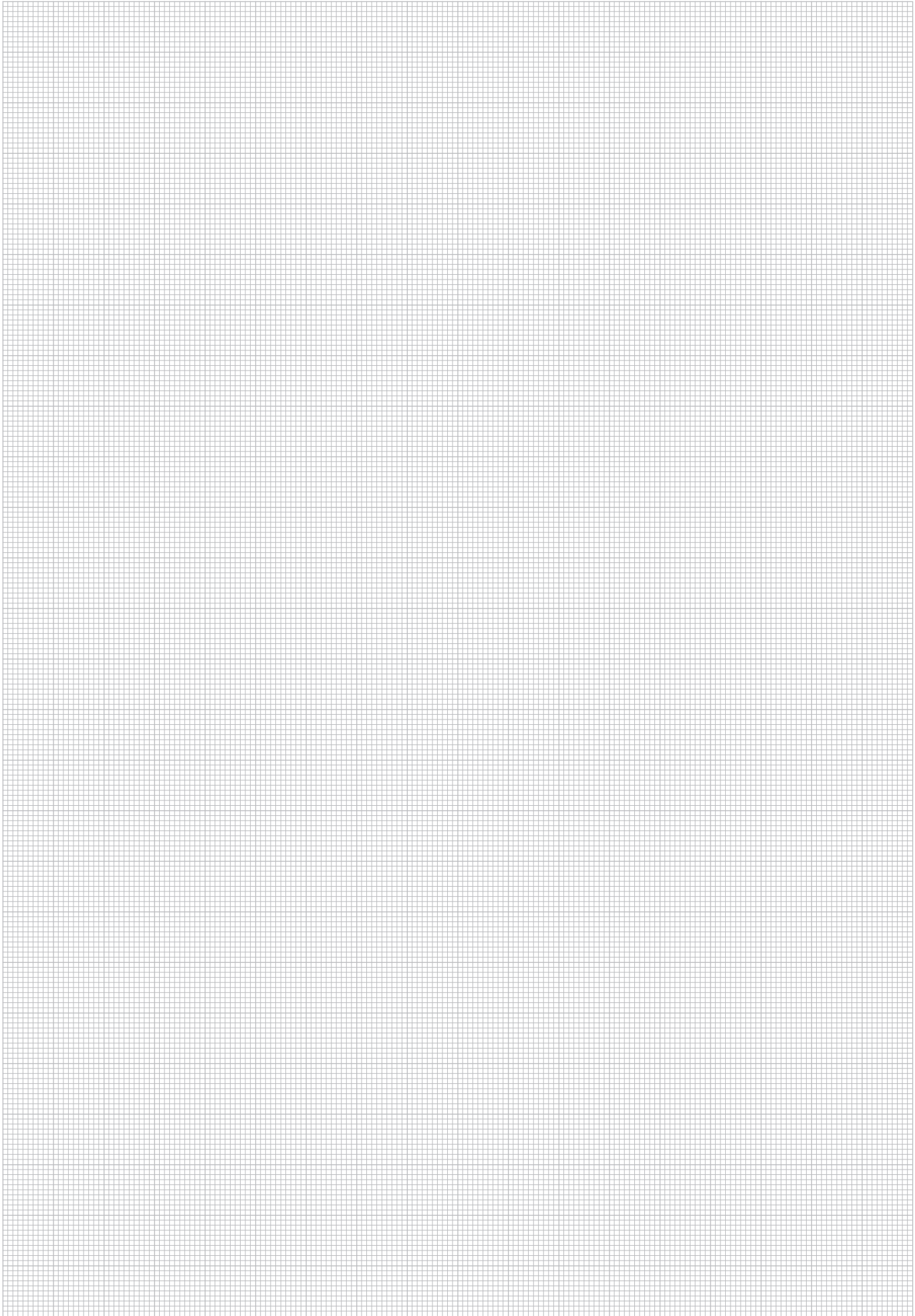



Gauge Fitting  
Type FI-MA-...-R • Series L / S

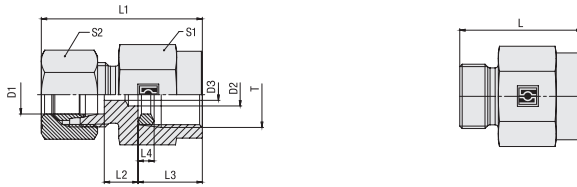

Internal Metallic Sealing Ring

Female Whitworth Parallel Pipe Thread (BSPP)

Series	Tube OD (mm/in)	PN (bar/PSI)	Dimensions (mm/in)	Dimensions										Weight (% ca.) per 100	Ordering Codes <sup>3</sup>
				Thread	T	D2	D3	L	L1 <sup>1</sup>	L2	L3	L4	S1		
L	6	500	G 1/4	5,5	4	29	37	7,5	14,5	4,5	19	14	3,76	FI-MA-06LR-W3-DKI	
	.24	7250		.22	.16	1.14	1.46	.30	.57	.18	.75	.55	8,27		
	8	500	G 1/4	5,5	5,5	29	37	7,5	14,5	4,5	19	17	3,74	FI-MA-08LR-W3-DKI	
	.31	7250		.22	.22	1.14	1.46	.30	.57	.18	.75	.67	8,23		
	10	500	G 1/4	5,5	5,5	30	38	8,5	14,5	4,5	19	19	4,05	FI-MA-10LR-W3-DKI	
	.39	7250		.22	.22	1.18	1.50	.33	.57	.18	.75	.75	8,92		
	12	400	G 1/4	5,5	5,5	30	38	8,5	14,5	4,5	19	22	4,31	FI-MA-12LR-W3-DKI	
	.47	5801		.22	.22	1.18	1.50	.33	.57	.18	.75	.87	9,48		
	S	6	800	G 1/2	7	4	38	46	11	20	5	27	17	9,16	FI-MA-06SR-W3-DKI
		.24	11600		.28	.16	1.50	1.81	.43	.79	.20	1.06	.67	2,16	
8		800	G 1/4	6	3,5	31	39	9,5	14,5	4,5	19	19	4,38	FI-MA-08SR1/4-W3-DKI	
.31		11600		.24	.14	1.22	1.54	.37	.57	.18	.75	.75	9,66		
8		800	G 1/2	7	5	38	46	11	20	5	27	19	9,30	FI-MA-08SR-W3-DKI	
.31		11600		.28	.20	1.50	1.81	.43	.79	.20	1.06	.75	2,46		
10		800	G 1/2	7	3,5	38	47	10,5	20	5	27	22	9,39	FI-MA-10SR-W3-DKI	
.39		11600		.28	.14	1.50	1.85	.41	.79	.20	1.06	.87	2,65		
12		630	G 1/4	5,5	5,5	34	43,5	12	14,5	4,5	22	24	6,72	FI-MA-12SR1/4-W3-DKI	
.47		9135		.22	.22	1.34	1.71	.47	.57	.18	.87	.94	14,82		
12	630	G 1/2	7	3,5	38	47	10,5	20	5	27	24	9,76	FI-MA-12SR-W3-DKI		
.47	9135		.28	.14	1.50	1.85	.41	.79	.20	1.06	.94	21,47			

<sup>1</sup> Approximate dimension in assembled condition.

<sup>2</sup> Weight excluding cutting ring and union nut.

<sup>3</sup> Standard scope of delivery: Fitting body only.

Ordering Codes

\*FI-MA\*-10\*L\*R\*-W3\*-DKI

* Gauge Fitting	FI-MA
* Outside Tube Diameter D1 (in mm)	-10
* Series	Light Series L Heavy Series S
* Thread Type	Female Whitworth Parallel Pipe Thread (BSPP) R
If required, please indicate special sizes, e.g. R1/2!	
* Material Code	Steel, zinc/nickel-plated -W3
Please contact STAUFF for alternative materials and surface finishings.	
* Internal Seal Type	Internal metallic sealing ring -DKI
* Assembling / Kitting	Fitting body only —
	Fitting body supplied with cutting ring and union nut -MS
	Fitting body supplied with soft-sealing cutting ring and union nut -MSV

Connecting Parts

	Cutting Ring Type FI-DS	Page 28
	Soft-Sealing Cutting Ring Type FI-WDDS	Page 29
	Support Sleeve Type FI-VH	Page 31
	STAUFF Form EVO Sealing Ring Type FI-FD	Page 32
	Union Nut Type FI-M	Page 33
	37° Flared Tube Fitting Set Type FI-AB	Page 37

Spare Parts / Accessories

	Internal Metallic Sealing Ring Type FI-DKI	Page 246
--	---	----------



Gauge Fitting with 24° Taper / O-Ring  
Type FI-EMAD-...-R ▪ Series L / S

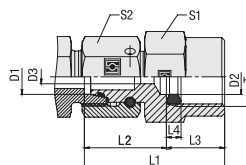

Female Whitworth Parallel Pipe Thread (BSPP)

Internal Metallic Sealing Ring

Ordering Codes

**\*FI-EMAD\*-10\*L\*R\*-V\*-W3\*-DKI-DKO**

- \* Gauge Fitting with 24° Taper / O-Ring **FI-EMAD**
- \* Outside Tube Diameter D1 (in mm) **-10**
- \* Series **L**  
Light Series  
Heavy Series **S**
- \* Thread Type **R**  
Female Whitworth Parallel  
Pipe Thread (BSPP)
- If required, please indicate special sizes, e.g. R1/2!
- \* Seal Material **-V**  
FKM (Viton®)  
**-E**  
EPDM
- \* Material Code **-W3**  
Steel, zinc/nickel-plated
- Please contact STAUFF for alternative materials and surface finishings.
- \* Internal Seal Type **-DKI**  
Internal metallic sealing ring
- \* Assembling / Kitting **-DKO**  
Fitting body supplied with  
swivel nut and O-ring

Series	Tube OD (mm/in) D1	PN (bar/psi)	Dimensions (mm/in)										Weight (kg/lbs) ca. per 100	Ordering Codes
			Thread	T	D2	D3	L1	L2	L3	L4	S1	S2		
L	6	500	G 1/4	5,5	3	38,5	24	14,5	4,5	19	14	6,34	FI-EMAD-06LR-V-W3-DKI-DKO	
	.24	7251		.22	.12	1.52	.94	.57	.18	.75	.55	13.95		
	8	500	G 1/4	5,5	3	38,5	24	14,5	4,5	19	17	6,16	FI-EMAD-08LR-V-W3-DKI-DKO	
	.31	7251		.22	.14	1.52	.94	.57	.18	.75	.67	13.56		
	10	500	G 1/4	5,5	3,5	39,5	25	14,5	4,5	19	19	7,22	FI-EMAD-10LR-V-W3-DKI-DKO	
	.39	7251		.22	.14	1.56	.98	.57	.18	.75	.75	15.88		
	12	315	G 1/4	5,5	3,5	41	26,5	14,5	4,5	19	22	8,48	FI-EMAD-12LR-V-W3-DKI-DKO	
	.47	4568		.22	.14	1.61	1.04	.57	.18	.75	.87	18.66		
	12	315	G 1/2	7	3,5	44,5	24,5	20	5	27	22	12,8	FI-EMAD-12LR1/2-V-W3-DKI-DKO	
	.47	4568		.28	.14	1.75	.96	.79	.2	1.06	.87	28,15		
	S	6	630	G 1/4	5,5	3,0	38	23,5	14,5	4,5	19	17	6,08	FI-EMAD-06SR1/4-V-W3-DKI-DKO
		.24	9135		.22	.12	1.50	.93	.57	.18	.75	.67	13.38	
6		630	G 1/2	7	3	45	25	20	5	27	17	11,49	FI-EMAD-06SR-V-W3-DKI-DKO	
.24		9135		.28	.12	1.77	.98	.79	.20	1.06	.67	25.29		
8		630	G 1/4	5,5	3,5	38	24	14,5	4,5	19	19	6,55	FI-EMAD-08SR1/4-V-W3-DKI-DKO	
.31		9135		.22	.14	1.50	.94	.57	.18	.75	.75	14.41		
8		630	G 1/2	7	3,5	43,5	23,5	20	5	27	19	10,87	FI-EMAD-08SR-V-W3-DKI-DKO	
.31		9135		.28	.14	1.71	.93	.79	.20	1.06	.75	23.92		
10		630	G 1/4	5,5	3,5	39,5	25	14,5	4,5	19	22	7,66	FI-EMAD-10SR1/4-V-W3-DKI-DKO	
.39		9135		.22	.14	1.56	.98	.57	.18	.75	.87	16.86		
10		630	G 1/2	7	3,5	44	24	20	5	27	22	12,19	FI-EMAD-10SR-V-W3-DKI-DKO	
.39		9135		.28	.14	1.73	.94	.79	.20	1.06	.87	26.83		
12	630	G 1/4	5,5	3,5	40	25,5	14,5	4,5	19	24	9,40	FI-EMAD-12SR1/4-V-W3-DKI-DKO		
.47	9135		.22	.14	1.57	1.00	.57	.18	.75	.94	20.69			
12	630	G 1/2	7	3,5	45,5	25,5	20	5	27	24	13,98	FI-EMAD-12SR-V-W3-DKI-DKO		
.47	9135		.28	.14	1.79	1.00	.79	.20	1.06	.94	30.76			

Standard seal material is FKM (Viton®).

Spare Parts / Accessories



O-Ring  
Type **O-RING** Page 239



Internal Metallic Sealing Ring  
Type **FI-DKI** Page 246



Gauge Standpipe Fitting  
Type FI-EMA-...-R ▪ Series L / S

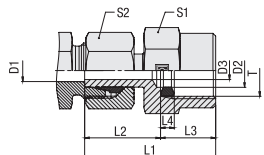

Internal Metallic Sealing Ring

Female Whitworth Parallel Pipe Thread (BSPP)

Series	Tube OD (mm/in)	PN (bar/PSI)	Dimensions (mm/in)	Dimensions										Weight (kg/lbs) Ca. per 100 <sup>1</sup>	Ordering Codes
				Thread T	D2	D3	L1	L2	L3	L4	S1	S2			
L	6	315	G 1/4	5,5	3,3	38	23,5	14,5	4,5	19	14	4,65	FI-EMA-06LR-W3-DKI-SV		
	.24	4568		.22	.13	1.5	.93	.57	.18	.75	.55	10.23			
	8	315	G 1/4	5,5	3,5	38	23,5	14,5	4,5	19	17	5,53	FI-EMA-08LR-W3-DKI-SV		
	.31	4568		.22	.14	1.5	.93	.57	.18	.75	.67	12.16			
	10	315	G 1/4	5,5	3,5	39,5	25	14,5	4,5	19	19	6,40	FI-EMA-10LR-W3-DKI-SV		
	.39	4568		.22	.14	1.56	.98	.57	.18	.75	.75	14.08			
	12	315	G 1/4	5,5	3,5	40,5	26	14,5	4,5	19	22	8,01	FI-EMA-12LR-W3-DKI-SV		
	.47	4568		.22	.14	1.59	1.02	.57	.18	.75	.87	17.63			
	12	315	G 1/2	12	5,5	46,5	26,5	20	5	27	22	11,89	FI-EMA-12LR1/2-W3-DKI-SV		
	.47	4568		.47	.22	1.83	1.04	.79	.2	1.06	.87	26.21			
S	6	630	G 1/2	7	3,5	45	25	20	5	27	17	10,73	FI-EMA-06SR-W3-DKI-SV		
	.24	9135		.28	.14	1.77	.98	.79	.2	1.06	.67	23.61			
	8	630	G 1/2	7	3,5	45	25	20	5	27	19	10,95	FI-EMA-08SR-W3-DKI-SV		
	.31	9135		.28	.14	1.77	.98	.79	.2	1.06	.75	24.09			
	10	630	G 1/2	7	3,5	47	27	20	5	27	22	12,15	FI-EMA-10SR-W3-DKI-SV		
	.39	9135		.28	.14	1.85	1.06	.79	.2	1.06	.87	26.73			
	12	630	G 1/4	5,5	3,5	40,2	25,7	14,5	4,5	19	24	8,78	FI-EMA-12SR1/4-W3-DKI-SV		
	.47	9135		.22	.14	1.58	1.01	.57	.18	.75	.94	19.36			
	12	630	G 1/2	7	3,5	47,5	27,5	20	5	27	24	13,43	FI-EMA-12SR-W3-DKI-SV		
	.47	9135		.28	.14	1.87	1.08	.79	.2	1.06	.94	29.55			

Ordering Codes

\*FI-EMA\*-10\*L\*R\*-W3\*-DKI-SV

- \* Gauge Standpipe Fitting FI-EMA
- \* Outside Tube Diameter D1 (in mm) -10
- \* Series L  
S
  - Light Series
  - Heavy Series
- \* Thread Type R
  - Female Whitworth Parallel Pipe Thread (BSPP)
- If required, please indicate special sizes, e.g. R1/2!
- \* Material Code -W3
  - Steel, zinc/nickel-plated
- Please contact STAUFF for alternative materials and surface finishings.
- \* Internal Seal Type -DKI
  - Internal metallic sealing ring
- \* Assembling / Kitting -SV
  - Standpipe factory-assembled with cutting ring and union nut

<sup>1</sup> Weight including cutting ring and union nut.

Please note: Standpipes are always factory-assembled with cutting rings and union nuts.

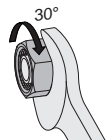

The union nut assembled on the standpipe has to be tightened by only 1/12 a turn (equivalent to 30°) beyond the fixed point.

Spare Parts / Accessories



Internal Metallic Sealing Ring  
Type FI-DKI Page 246



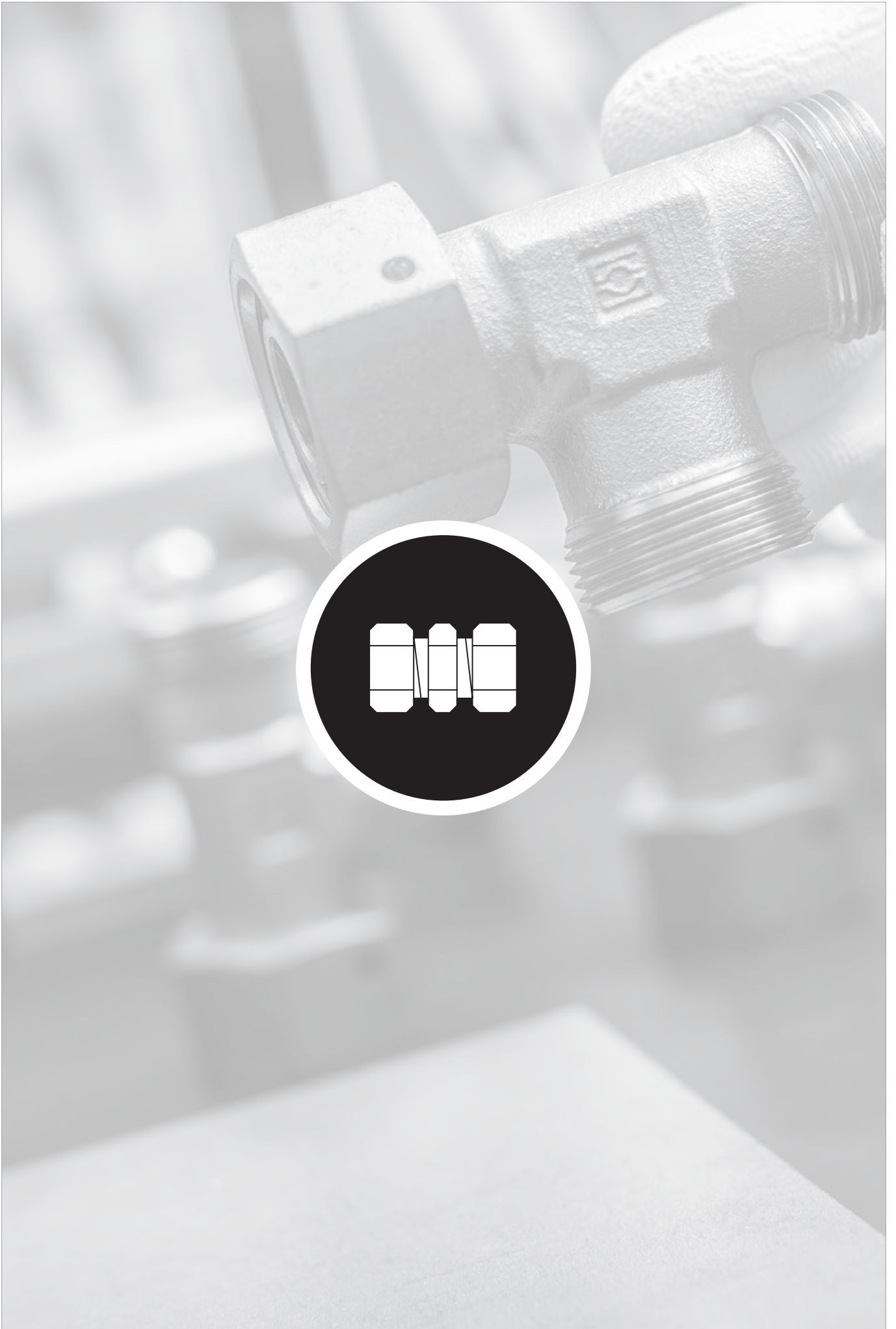

	<b>Straight Male Stud Fitting with 24° Taper / O-Ring</b>	134-137
	FI-EGED	
	<b>Whitworth Parallel Pipe Thread (BSPP) / Profile Sealing Ring</b>	134
	FI-EGED-...-R-WD	
	<b>Metric Parallel Thread / Profile Sealing Ring</b>	136
	FI-EGED-...-M-WD	
	<b>NPT Thread</b>	137
	FI-EGED-...-N	
	<b>Straight Fitting with 24° Taper / O-Ring</b>	138
	FI-SNV	
	<b>Straight Reducer with 24° Taper / O-Ring</b>	140
	FI-SNV	
	<b>Straight Reducer for Tube Ends with 24° Taper / O-Ring</b>	144
	FI-RESD	
	<b>Distance Adaptors with 24° Taper / O-Ring</b>	148
	FI-RESD	
	<b>Adjustable Elbow (90°) with 24° Taper / O-Ring</b>	150
	FI-EWD	
	<b>Adjustable Elbow (45°) with 24° Taper / O-Ring</b>	151
	FI-EVD	
	<b>Adjustable Branch Tee with 24° Taper / O-Ring</b>	152
	FI-ETD	
	<b>Adjustable Barrel Tee with 24° Taper / O-Ring</b>	153
	FI-ELD	



**Straight Male Stud Fitting with 24° Taper / O-Ring  
Type FI-EGED-...-R-WD ▪ Series L**

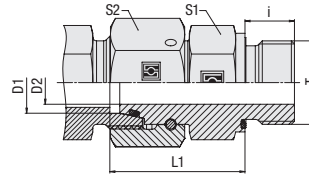

**Whitworth Parallel Pipe Thread (BSPP)**

**Profile Sealing Ring**

**Ordering Codes**

**\*FI-EGED\*-10\*L\*R\*-WD\*-BV\*-W3\*-DKO**

\* Straight Male Stud Fitting with 24° Taper / O-Ring (DKO) **FI-EGED**

\* Outside Tube Diameter D1 (in mm) **-10**

\* Series Light Series (page 134) **L**  
Heavy Series (page 135) **S**

\* Thread Type Whitworth Parallel Pipe Thread (BSPP) **R**

If required, please indicate special sizes, e.g. R3/8!

\* Seal Type Profile Sealing Ring **-WD**

\* Seal Material Male Stud: NBR (Buna-N®) **-BV**  
24° Taper: FKM (Viton®)  
FKM (Viton®) **-V**  
EPDM **-E**

\* Material Code Steel, zinc/nickel-plated **-W3**

Please contact STAUFF for alternative materials and surface finishings.

\* Assembling / Kitting Fitting body supplied with swivel nut and O-ring **-DKO**

**Spare Parts / Accessories**



O-Ring  
Type **O-RING** Page 239



Profile Sealing Ring  
Type **WDG** Page 238

Series	Tube OD (mm/in) D1	PN (bar/psi)	Dimensions (mm/in)						Torque (Nm/ft-lb) Thread T	Weight (% / lbs) ca. per 100	Ordering Codes
			Thread T	D2	i	L1	S1	S2			
L	6	500	G 1/8	2,5	8	24,5	14	14	18	3,74	FI-EGED-06LR-WD-BV-W3-DKO
	.24	7250		.10	.31	.96	.55	.55	13.3	8.22	
	6	500	G 1/4	2,5	12	27,5	19	14	35	5,42	FI-EGED-06LR1/4-WD-BV-W3-DKO
	.24	7250		.1	.47	1.08	.75	.55	25.9	11.95	
	8	500	G 1/8	4	8	25,5	14	17	18	3,96	FI-EGED-08LR1/8-WD-BV-W3-DKO
	.31	7250		.16	.31	1.0	.55	.67	13.3	8.73	
	8	500	G 1/4	4	12	29,5	19	17	35	5,23	FI-EGED-08LR-WD-BV-W3-DKO
	.31	7250		.16	.47	1.16	.75	.67	25.9	11.50	
	8	400	G 3/8	5	12	28,5	22	17	70	7,16	FI-EGED-08LR3/8-WD-BV-W3-DKO
	.31	5800		.2	.47	1.12	.87	.67	51.8	15.79	
	10	500	G 1/4	6	12	27,5	19	19	35	5,68	FI-EGED-10LR-WD-BV-W3-DKO
	.39	7250		.24	.47	1.08	.75	.75	25.9	12.49	
	10	400	G 3/8	6,5	12	34,5	22	19	70	7,69	FI-EGED-10LR3/8-WD-BV-W3-DKO
	.39	5800		.26	.47	1.36	.87	.75	51.8	16.95	
	10	400	G 1/2	6,5	14	36	27	19	90	13,5	FI-EGED-10LR1/2-WD-BV-W3-DKO
	.39	5800		.26	.55	1.42	1.06	.75	66.6	29.76	
	12	500	G 1/4	6	12	29,5	19	22	35	7,02	FI-EGED-12LR1/4-WD-BV-W3-DKO
	.47	7250		.24	.47	1.1	.75	.87	25.9	15.48	
	12	400	G 3/8	8	12	34	22	22	70	9,78	FI-EGED-12LR-WD-BV-W3-DKO
	.47	5800		.31	.47	1.34	.87	.87	51.8	21.52	
	12	400	G 1/2	8	14	29,5	27	22	90	11,71	FI-EGED-12LR1/2-WD-BV-W3-DKO
	.47	5800		.31	.55	1.16	1.06	.87	66.6	25.76	
	15	400	G 3/8	9	12	31,5	22	27	70	10,74	FI-EGED-15LR3/8-WD-BV-W3-DKO
	.59	5800		.35	.47	1.24	.87	1.06	51.8	23.68	
	15	400	G 1/2	10	14	32	27	27	90	13,70	FI-EGED-15LR-WD-BV-W3-DKO
	.59	5800		.39	.55	1.26	1.06	1.06	66.6	30.14	
	15	250	G 3/4	11	16	31	32	27	180	14,89	FI-EGED-15LR3/4-WD-BV-W3-DKO
	.59	3625		.43	.63	1.22	1.26	1.06	133.2	32.83	
	18	400	G 1/2	13	14	31,5	27	32	90	14,86	FI-EGED-18LR-WD-BV-W3-DKO
	.71	5800		.51	.55	1.24	1.06	1.26	66.6	32.69	
	18	250	G 3/4	13	16	31	32	32	180	17,92	FI-EGED-18LR3/4-WD-BV-W3-DKO
	.71	3625		.51	.63	1.22	1.26	1.26	133.2	39.51	
	22	250	G 1/2	17	14	34,5	32	36	90	19	FI-EGED-22LR1/2-WD-BV-W3-DKO
	.87	3625		.67	.55	1.36	1.26	1.42	66.6	41.89	
	22	250	G 3/4	17	16	32,5	32	36	180	20,98	FI-EGED-22LR-WD-BV-W3-DKO
	.87	3625		.67	.63	1.28	1.26	1.42	133.2	46.15	
	22	250	G 1	17	18	34,5	41	36	310	31,66	FI-EGED-22LR1-WD-BV-W3-DKO
	.87	3625		.67	.71	1.36	1.61	1.42	229.4	69.80	
	28	250	G 3/4	23	16	35	36	41	180	22,99	FI-EGED-28LR3/4-WD-BV-W3-DKO
	1.10	3625		.91	.63	1.38	1.42	1.61	133.2	50.68	
	28	250	G 1	22	18	35	41	41	310	22,78	FI-EGED-28LR-WD-BV-W3-DKO
	1.10	3625		.87	.71	1.38	1.61	1.61	229.4	50.12	
	35	250	G 1 1/4	28	20	42,5	50	50	450	51,00	FI-EGED-35LR-WD-BV-W3-DKO
	1.38	3625		1.10	.79	1.67	1.97	1.97	333.0	112.20	
	35	250	G 1 1/2	28	22	46,5	55	50	540	61,3	FI-EGED-35LR1-1/2-WD-BV-W3-DKO
	1.38	3625		1.1	.87	1.83	2.17	1.97	399.6	135.14	
	42	250	G 1 1/4	35	20	47	55	60	450	62,8	FI-EGED-42LR1-1/4-WD-BV-W3-DKO
	1.65	3625		1.38	.79	1.85	2.17	2.36	333.0	138.45	
	42	250	G 1 1/2	34	22	46,5	55	60	540	68,60	FI-EGED-42LR-WD-BV-W3-DKO
	1.65	3625		1.34	.87	1.83	2.17	2.36	399.6	150.92	

Standard seal material: See Ordering Code BV.

Male stud acc. to ISO 1179-2 (Type E)  
Port acc. to ISO 1179-1

Male threaded studs were designed for female threaded ports in components made of steel. For applications with components made of softer mating materials (e.g. Aluminium), the use of connectors with additionally rolled male threads is recommended.

Torque recommendations for Steel mating material.

Please contact STAUFF prior to the assembly for further information.

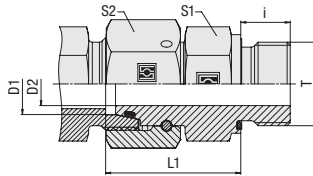

Straight Male Stud Fitting with 24° Taper / O-Ring  
 Type FI-EGED-...-R-WD ▪ Series S

## Whitworth Parallel Pipe Thread (BSPP)

## Profile Sealing Ring

Series	Tube OD (mm/in)	PN (bar/PSI)	Dimensions (mm/in)					Torque (Nm/ft-lb)	Weight (kg/lbs) ca.	Ordering Codes	
			Thread T	D2	i	L1	S1				S2
S	6	800	G 1/4	2,5	12	27	19	17	55	5,55	FI-EGED-06SR-WD-BV-W3-DKO
	.24	11600		.10	.47	1.06	.75	.67	40.7	12.21	
8	800	11600	G 1/4	4	12	29,5	19	19	55	6,52	FI-EGED-08SR-WD-BV-W3-DKO
	.31			.16	.47	1.16	.75	.75	40.7	14.34	
8	800	11600	G 3/8	4	12	32	22	19	80	8,25	FI-EGED-08SR3/8-WD-BV-W3-DKO
	.31			.16	.47	1.26	.87	.75	59.2	18.19	
10	800	11600	G 1/4	6	12	29,5	19	22	55	7,19	FI-EGED-10SR1/4-WD-BV-W3-DKO
	.39			.24	.47	1.16	.75	.87	40.7	15.85	
10	800	11600	G 3/8	6	12	32	22	22	80	9,63	FI-EGED-10SR-WD-BV-W3-DKO
	.39			.24	.47	1.26	.87	.87	59.2	21.19	
12	630	9135	G 1/4	5	12	33	19	24	55	9,05	FI-EGED-12SR1/4-WD-BV-W3-DKO
	.47			.2	.47	1.3	.75	.94	40.7	19.95	
12	630	9135	G 3/8	8	12	34	22	24	80	7,03	FI-EGED-12SR-WD-BV-W3-DKO
	.47			.31	.47	1.34	.87	.94	59.2	15.46	
12	630	9135	G 1/2	8	14	36	27	24	115	6,36	FI-EGED-12SR1/2-WD-BV-W3-DKO
	.47			.31	.55	1.42	1.06	.94	85.1	14.02	
14	630	9135	G 1/2	9	14	37	27	27	115	14,39	FI-EGED-14SR-WD-BV-W3-DKO
	.55			.35	.55	1.46	1.06	1.06	85.1	31.67	
16	630	9135	G 3/8	8	12	37,5	27	30	80	16,88	FI-EGED-16SR3/8-WD-BV-W3-DKO
	.63			.31	.47	1.48	1.06	1.18	59.2	37.21	
16	630	9135	G 1/2	11	14	37	27	30	115	17,03	FI-EGED-16SR-WD-BV-W3-DKO
	.63			.43	.55	1.46	1.06	1.18	85.1	37.46	
16	420	6091	G 3/4	11	16	39,5	32	30	180	23,9	FI-EGED-16SR3/4-WD-BV-W3-DKO
	.63			.43	.63	1.56	1.26	1.18	133.2	52.69	
20	420	6091	G 1/2	12	14	40,5	27	36	115	22,47	FI-EGED-20SR1/2-WD-BV-W3-DKO
	.79			.47	.55	1.59	1.06	1.42	85.1	49.54	
20	420	6091	G 3/4	14	16	43	32	36	180	27,34	FI-EGED-20SR-WD-BV-W3-DKO
	.79			.55	.63	1.69	1.26	1.42	133.2	60.15	
25	420	6091	G 3/4	17	16	49	36	46	180	42,11	FI-EGED-25SR3/4-WD-BV-W3-DKO
	.98			.67	.63	1.93	1.42	1.81	133.2	92.84	
25	420	6091	G 1	18	18	48	41	46	310	50,20	FI-EGED-25SR-WD-BV-W3-DKO
	.98			.71	.71	1.89	1.61	1.81	229.4	110.44	
30	420	6091	G 1 1/4	23	20	51	50	50	450	70,40	FI-EGED-30SR-WD-BV-W3-DKO
	1.18			.91	.79	2.01	1.97	1.97	333.0	154.88	
30	420	6091	G 1 1/2	22	22	53,5	55	50	540	83,5	FI-EGED-30SR1-1/2-WD-BV-W3-DKO
	1.18			.87	.87	2.11	2.17	1.97	399.6	184.09	
30	420	6091	G 1	20	18	50,5	41	50	310	54,7	FI-EGED-30SR1-WD-BV-W3-DKO
	1.18			.79	.71	1.99	1.61	1.97	229.4	120.59	
38	420	6091	G 1 1/4	30	20	56	55	60	450	92,4	FI-EGED-38SR1-1/4-WD-BV-W3-DKO
	1.50			1.18	.79	2.2	2.17	2.36	333.0	203.71	
38	420	6091	G 1 1/2	30	22	60	55	60	540	93,50	FI-EGED-38SR-WD-BV-W3-DKO
	1.50			1.18	.87	2.36	2.17	2.36	399.6	205.70	

## Ordering Codes

**\*FI-EGED\*-10\*S\*R\*-WD\*-BV\*-W3\*-DKO**

- \* Straight Male Stud Fitting with 24° Taper / O-Ring (DKO) FI-EGED
- \* Outside Tube Diameter D1 (in mm) -10
- \* Series L  
S
  - Light Series (page 134)
  - Heavy Series (page 135)
- \* Thread Type R
  - Whitworth Parallel Pipe Thread (BSPP)
- If required, please indicate special sizes, e.g. R3/8!
- \* Seal Type -WD
  - Profile Sealing Ring
- \* Seal Material -BV  
-V  
-E
  - Male Stud: NBR (Buna-N®)
  - 24° Taper: FKM (Viton®)
  - FKM (Viton®)
  - EPDM
- \* Material Code -W3
  - Steel, zinc/nickel-plated
- Please contact STAUFF for alternative materials and surface finishings.
- \* Assembling / Kitting -DKO
  - Fitting body supplied with swivel nut and O-ring

## Spare Parts / Accessories

- O-Ring  
Type **O-RING** Page 239
- Profile Sealing Ring  
Type **WDG** Page 238

Standard seal material: See Ordering Code BV.

 Male stud acc. to ISO 1179-2 (Type E)  
 Port acc. to ISO 1179-1

Male threaded studs were designed for female threaded ports in components made of steel. For applications with components made of softer mating materials (e.g. Aluminium), the use of connectors with additionally rolled male threads is recommended.

Please contact STAUFF prior to the assembly for further information.

Torque recommendations for Steel mating material.



**Straight Male Stud Fitting with 24° Taper / O-Ring**  
**Type FI-EGED-...-M-WD ▪ Series L / S**

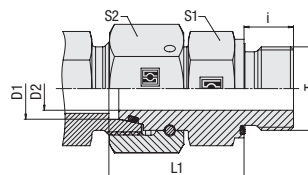

**Profile Sealing Ring**

**Metric Parallel Thread**

**Ordering Codes**

**\*FI-EGED\*-10\*L\*M\*-WD\*-BV\*-W3\*-DKO**

\* Straight Male Stud Fitting with 24° Taper / O-Ring (DKO) **FI-EGED**

\* Outside Tube Diameter D1 (in mm) **-10**

\* Series Light Series **L**  
 Heavy Series **S**

\* Thread Type Metric Parallel Thread **M**

If required, please indicate special sizes, e.g. M12x1.5!

\* Seal Type Profile Sealing Ring **-WD**

\* Seal Material Male Stud: NBR (Buna-N®) **-BV**  
 24° Taper: FKM (Viton®) **-V**  
 FKM (Viton®) **-E**  
 EPDM **-E**

\* Material Code Steel, zinc/nickel-plated **-W3**

Please contact STAUFF for alternative materials and surface finishings.

\* Assembling / Kitting Fitting body supplied with swivel nut and O-ring **-DKO**

**Spare Parts / Accessories**



O-Ring  
 Type **O-RING** Page 239



Profile Sealing Ring  
 Type **WDG** Page 238

Series	Tube OD (mm/in) D1	PN (bar/PSI)	Dimensions (mm/in)							Torque (Nm/ft-lb)	Weight (kg/lbs) ca. per 100	Ordering Codes
			Thread T	D2	i	L1	S1	S2	Thread T			
L	6	500	M10x1	2,5	8	24,5	14	14	18	3,76	FI-EGED-06LM-WD-BV-W3-DKO	
	.24	7250		.10	.31	.96	.55	.55	13.3	8.27		
	8	500	M12x1,5	4	12	26,5	17	17	25	4,64	FI-EGED-08LM-WD-BV-W3-DKO	
	.31	7250		.16	.47	1.04	.67	.67	18.5	10.21		
	10	500	M14x1,5	6	12	27,5	19	19	45	5,97	FI-EGED-10LM-WD-BV-W3-DKO	
	.39	7250		.24	.47	1.08	.75	.75	33.3	13.14		
	12	400	M16x1,5	8	12	30,5	22	22	55	9,58	FI-EGED-12LM-WD-BV-W3-DKO	
	.47	5800		.31	.47	1.20	.87	.87	40.7	21.08		
	12	400	M18x1,5	8	12	31	24	22	90	9,78	FI-EGED-12LM18x1.5-WD-BV-W3-DKO	
	.47	5800		.31	.47	1.22	.94	.87	66.6	21.56		
	15	400	M18x1,5	10	12	31,5	24	27	90	12,62	FI-EGED-15LM-WD-BV-W3-DKO	
	.59	5800		.39	.47	1.24	.94	1.06	66.6	27.76		
	15	400	M22x1,5	11	14	34	27	27	125	14,26	FI-EGED-15LM22x1.5-WD-BV-W3-DKO	
	.59	5800		.43	.55	1.34	1.06	1.06	92.5	31.44		
	18	400	M22x1,5	13	14	31,5	27	32	125	15,28	FI-EGED-18LM-WD-BV-W3-DKO	
	.71	5800		.51	.55	1.24	1.06	1.26	92.5	33.62		
	22	250	M26x1,5	17	16	32,5	32	36	180	20,75	FI-EGED-22LM-WD-BV-W3-DKO	
	.87	3625		.67	.63	1.28	1.26	1.42	133.2	45.64		
	28	250	M33x2	22	18	35	41	41	310	28,61	FI-EGED-28LM-WD-BV-W3-DKO	
	1.10	3625		.87	.71	1.38	1.61	1.61	229.4	62.95		
35	250	M42x2	28	20	42,5	50	50	450	52,30	FI-EGED-35LM-WD-BV-W3-DKO		
1.38	3625		1.10	.79	1.67	1.97	1.97	333.0	115.06			
42	250	M48x2	34	22	46,5	55	60	540	72,56	FI-EGED-42LM-WD-BV-W3-DKO		
1.65	3625		1.34	.87	1.83	2.17	2.36	399.6	159.62			
S	6	800	M12x1,5	2,5	12	27	17	17	35	4,88	FI-EGED-06SM-WD-BV-W3-DKO	
	.24	11600		.10	.47	1.06	.67	.67	25.9	10.73		
	8	800	M14x1,5	4	12	29,5	19	19	55	6,59	FI-EGED-08SM-WD-BV-W3-DKO	
	.31	11600		.16	.47	1.16	.75	.75	40.7	14.49		
	10	800	M16x1,5	6	12	32	22	22	70	9,34	FI-EGED-10SM-WD-BV-W3-DKO	
	.39	11600		.24	.47	1.26	.87	.87	51.80	20.54		
	12	630	M18x1,5	8	12	34	24	24	90	10,44	FI-EGED-12SM-WD-BV-W3-DKO	
	.47	9135		.31	.47	1.34	.94	.94	66.6	22.97		
	14	630	M20x1,5	9	14	36,5	27	27	125	16,00	FI-EGED-14SM-WD-BV-W3-DKO	
	.55	9135		.35	.55	1.44	1.06	1.06	92.5	35.21		
	16	630	M22x1,5	11	14	37	27	30	135	17,32	FI-EGED-16SM-WD-BV-W3-DKO	
	.63	9135		.43	.55	1.46	1.06	1.18	99.9	38.11		
	20	420	M27x2	14	16	43	32	36	180	27,99	FI-EGED-20SM-WD-BV-W3-DKO	
	.79	6091		.55	.63	1.69	1.26	1.42	133.2	61.58		
	25	420	M33x2	18	18	48	41	46	310	50,00	FI-EGED-25SM-WD-BV-W3-DKO	
	.98	6091		.71	.71	1.89	1.61	1.81	229.4	110.00		
	30	420	M42x2	23	20	51	50	50	450	70,30	FI-EGED-30SM-WD-BV-W3-DKO	
	1.18	6091		.91	.79	2.01	1.97	1.97	333.0	154.66		
	38	420	M48x2	30	22	60	55	60	540	94,50	FI-EGED-38SM-WD-BV-W3-DKO	
	1.50	6091		1.18	.87	2.36	2.17	2.36	399.6	207.90		

Standard seal material: See Ordering Code BV.

Male stud acc. to ISO 9974-2 (Type E)  
 Port acc. to ISO 9974-1

Male threaded studs were designed for female threaded ports in components made of steel. For applications with components made of softer mating materials (e.g. Aluminium), the use of connectors with additionally rolled male threads is recommended.

Torque recommendations for Steel mating material.

Please contact STAUFF prior to the assembly for further information.



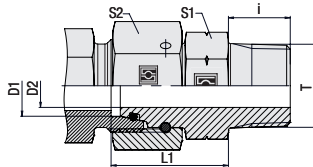

Straight Male Stud Fitting with 24° Taper / O-Ring  
 Type FI-EGED-...-N • Series L / S

NPT Thread

Series	Tube OD		Dimensions (mm/in)	Dimensions						Weight (kg/lbs) ca. per 100	Ordering Codes
	(mm/in)	PN (bar/PSI)		Thread	T	D2	i	L1	S1		
L	6	315	1/8 NPT	3	10	33	14	14	3,75	FI-EGED-06L1/8N-V-W3-DKO	
	.24	4567		.12	.39	1.3	.55	.55	8.27		
	8	315	1/4 NPT	5	15	41,5	14	17	4,53	FI-EGED-08L1/4N-V-W3-DKO	
	.31	4567		.2	.59	1.63	.55	.67	9.99		
	10	315	1/4 NPT	6,5	15	41,5	17	19	5,34	FI-EGED-10L1/4N-V-W3-DKO	
	.39	4567		.26	.59	1.63	.67	.75	11.77		
	12	315	3/8 NPT	8	15	46	19	22	8,42	FI-EGED-12L3/8N-V-W3-DKO	
	.47	4567		.31	.59	1.81	.75	.87	18.56		
	15	315	1/2 NPT	11	20	50	22	27	12,06	FI-EGED-15L1/2N-V-W3-DKO	
	.59	4567		.43	.79	1.97	.87	1.06	26.59		
	18	315	1/2 NPT	12	20	48	27	32	15,73	FI-EGED-18L1/2N-V-W3-DKO	
	.71	4567		.47	.79	1.89	1.06	1.26	34.68		
	22	160	3/4 NPT	17	20	51	30	36	20,22	FI-EGED-22L3/4N-V-W3-DKO	
	.87	2320		.67	.79	2.01	1.18	1.42	44.58		
	28	160	1 NPT	23	25	60	41	41	29,5	FI-EGED-28L1N-V-W3-DKO	
	1.10	2320		.91	.98	2.36	1.61	1.61	65.04		
	35	160	1 1/4 NPT	28	26	66,5	50	50	53,2	FI-EGED-35L1-1/4N-V-W3-DKO	
	1.38	2320		1.1	1.02	2.62	1.97	1.97	117.29		
	42	160	1 1/2 NPT	35	26	70	55	66	69,45	FI-EGED-42L1-1/2N-V-W3-DKO	
	1.65	2320		1.38	1.02	2.76	2.17	2.6	153.11		
S	6	630	1/4 NPT	3	15	42	17	17	4,2	FI-EGED-06S1/4N-V-W3-DKO	
	.24	9135		.12	.59	1.65	.67	.67	9.25		
	8	630	1/4 NPT	4	15	43	17	19	5,94	FI-EGED-08S1/4N-V-W3-DKO	
	.31	9135		.16	.59	1.69	.67	.75	13.1		
	10	630	3/8 NPT	6,5	15	44,5	19	22	8,42	FI-EGED-10S3/8N-V-W3-DKO	
	.39	9135		.26	.59	1.75	.75	.87	18.56		
	12	630	3/8 NPT	8	15	47	19	24	9,34	FI-EGED-12S3/8N-V-W3-DKO	
	.47	9135		.31	.59	1.85	.75	.94	20.59		
	14	630	1/2 NPT	9	20	54	24	27	15,1	FI-EGED-14S1/2N-V-W3-DKO	
	.55	9135		.35	.79	2.13	.94	1.06	33.29		
	16	400	1/2 NPT	11	20	54	24	27	15,63	FI-EGED-16S1/2N-V-W3-DKO	
	.63	5800		.43	.79	2.13	.94	1.06	34.46		
	20	400	3/4 NPT	14	20	57	30	36	25,5	FI-EGED-20S3/4N-V-W3-DKO	
	.79	5800		.55	.79	2.24	1.18	1.42	56.22		
	25	400	1 NPT	18	25	67	36	46	44,71	FI-EGED-25S1N-V-W3-DKO	
	.98	5800		.71	.98	2.64	1.42	1.81	98.57		
	30	400	1 1/4 NPT	22	26	71	50	50	72,11	FI-EGED-30S1-1/4N-V-W3-DKO	
	1.18	5800		.87	1.02	2.80	1.97	1.97	158.98		
38	315	1 1/2 NPT	30	26	79	55	60	95	FI-EGED-38S1-1/2N-V-W3-DKO		
1.50	4568		1.18	1.02	3.11	2.17	2.36	209.44			

## Ordering Codes

**\*FI-EGED\*-10\*L\*1/4\*N\*-V\*-W3\*-DKO**

- \* Straight Male Stud Fitting with 24° Taper / O-Ring (DKO) FI-EGED
- \* Outside Tube Diameter D1 (in mm) -10
- \* Series Light Series L  
Heavy Series S
- \* Thread Size acc. to dimension table 1/4
- Please always indicate thread sizes, e.g. 1/4!
- \* Thread Type NPT Thread N
- \* Seal Material FKM (Viton®) -V  
EPDM -E
- \* Material Code Steel, zinc/nickel-plated -W3
- Please contact STAUFF for alternative materials and surface finishings.
- \* Assembling / Kitting Fitting body supplied with swivel nut and O-ring -DKO

## Spare Parts / Accessories

 O-Ring  
 Type **O-RING**

Page 239

Standard seal material: See Ordering Code V.

 Male stud acc. to ANSI/ASME B1.20.1-1983  
 Port acc. to ANSI/ASME B1.20.1-1983

Male threaded studs were designed for female threaded ports in components made of steel. For applications with components made of softer mating materials (e.g. Aluminium), the use of connectors with additionally rolled male threads is recommended.

Suitable liquid / plastic sealant required.

Please contact STAUFF prior to the assembly for further information.

Torque recommendations for Steel mating material.



**Straight Fitting with 24° Taper / O-Ring  
Type FI-SNV • Series L**

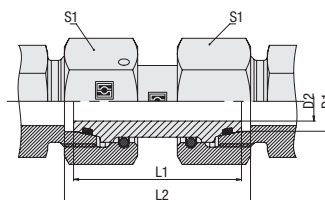

**Ordering Codes**

**\*FI-SNV\*-10\*L\*-V\*-W3\*-DKO**

- \* Straight Fitting with 24° Taper / O-Ring (DKO) **FI-SNV**
- \* Outside Tube Diameter D1 (in mm) **-10**
- \* Series **L**  
Light Series (page 138)  
Heavy Series (page 139) **S**
- \* Seal Material **-V**  
FKM (Viton®)  
EPDM **-E**
- \* Material Code **-W3**  
Steel, zinc/nickel-plated
- Please contact STAUFF for alternative materials and surface finishings.
- \* Assembling / Kitting **-DKO**  
Fitting body supplied with swivel nuts and O-rings
- \* Total length **-GLA**  
dimension see table **-GLB**  
dimension see table

**Spare Parts / Accessories**



O-Ring  
Type **O-RING**

Page 239

Series	Tube OD (mm/in)	PN (bar/PSI)	Dimensions (mm/in)				Weight (kg/lbs) ca. per 100	Ordering Codes
	D1		D2	L1	L2	S1		
L	6	500	3	30,8	33,5	14	2,81	FI-SNV-06L-V-W3-DKO-GLB
	.24	7250	.12	1.21	1.32	.55	6.19	
	6	500	3	34	36,7	14	3,82	FI-SNV-06L-V-W3-DKO
	.24	7250	.12	1.34	1.44	.55	8.42	
	6	500	3	36,3	39	14	2,99	FI-SNV-06L-V-W3-DKO-GLA
	.24	7250	.12	1.43	1.54	.55	6.59	
	8	500	5	30,8	33,5	17	4,19	FI-SNV-08L-V-W3-DKO-GLB
	.31	7250	.20	1.21	1.32	.67	9.24	
	8	500	5	34	36,7	17	4,29	FI-SNV-08L-V-W3-DKO
	.31	7250	.20	1.34	1.44	.67	9.46	
	8	500	5	36,8	39,5	17	4,45	FI-SNV-08L-V-W3-DKO-GLA
	.31	7250	.20	1.45	1.56	.67	9.81	
	10	500	6	32,2	34	19	5,56	FI-SNV-10L-V-W3-DKO-GLB
	.39	7250	.24	1.27	1.34	.75	12.26	
	10	500	6	36	37,8	19	5,78	FI-SNV-10L-V-W3-DKO
	.39	7250	.24	1.42	1.49	.75	12.74	
	10	500	6	37,7	39,5	19	6	FI-SNV-10L-V-W3-DKO-GLA
	.39	7250	.24	1.48	1.56	.75	13.23	
	12	400	8	32,2	34	22	7,5	FI-SNV-12L-V-W3-DKO-GLB
	.47	5800	.31	1.27	1.34	.87	16.53	
	12	400	8	36	37,8	22	7	FI-SNV-12L-V-W3-DKO
	.47	5800	.31	1.42	1.49	.87	15.40	
	12	400	8	39,5	41,3	22	8,04	FI-SNV-12L-V-W3-DKO-GLA
	.47	5800	.31	1.56	1.63	.87	17.73	
	15	400	11	39	40,8	27	12,58	FI-SNV-15L-V-W3-DKO
	.59	5800	.43	1.54	1.61	1.06	27.68	
	15	400	11	40,7	42,5	27	12,62	FI-SNV-15L-V-W3-DKO-GLA
	.59	5800	.43	1.60	1.67	1.06	27.82	
	18	400	13	36,2	39	32	17	FI-SNV-18L-V-W3-DKO-GLB
	.71	5800	.51	1.43	1.54	1.26	37.48	
	18	400	13	40,5	43,3	32	17,59	FI-SNV-18L-V-W3-DKO
	.71	5800	.51	1.59	1.70	1.26	38.70	
	18	400	13	42,2	45	32	18,16	FI-SNV-18L-V-W3-DKO-GLA
	.71	5800	.51	1.66	1.77	1.26	40.04	
	22	250	17	41,2	44	36	24,12	FI-SNV-22L-V-W3-DKO-GLB
	.87	3625	.67	1.62	1.73	1.42	53.18	
	22	250	17	45	47,8	36	24,91	FI-SNV-22L-V-W3-DKO
	.87	3625	.67	1.77	1.88	1.42	54.80	
	22	250	17	46,7	49,5	36	25,4	FI-SNV-22L-V-W3-DKO-GLA
	.87	3625	.67	1.84	1.95	1.42	56	
	28	250	23	46	48,8	41	27,4	FI-SNV-28L-V-W3-DKO
	1.10	3625	.91	1.81	1.92	1.61	60.28	
	28	250	23	48,7	51,5	41	28,57	FI-SNV-28L-V-W3-DKO-GLA
	1.10	3625	.91	1.92	2.03	1.61	62.99	
	35	250	28	46	52	50	43,36	FI-SNV-35L-V-W3-DKO-GLB
	1.38	3625	1.10	1.81	2.05	1.97	95.59	
	35	250	28	53	59	50	45,98	FI-SNV-35L-V-W3-DKO
	1.38	3625	1.10	2.09	2.32	1.97	101.15	
	35	250	28	55	61	50	47,1	FI-SNV-35L-V-W3-DKO-GLA
	1.38	3625	1.10	2.17	2.40	1.97	103.84	
	42	250	35	53	60	60	69,5	FI-SNV-42L-V-W3-DKO
	1.65	3625	1.38	2.09	2.36	2.36	152.90	
	42	250	34	55,5	62,5	60	71,5	FI-SNV-42L-V-W3-DKO-GLA
	1.65	3625	1.34	2.19	2.46	2.36	157.63	

Standard seal material is FKM (Viton®).

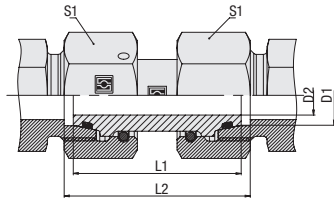

**Straight Fitting with 24° Taper / O-Ring  
Type FI-SNV • Series S**

Series	Tube OD	PN	Dimensions				Weight ( <sup>kg</sup> / <sub>lbs</sub> ) ca. per 100	Ordering Codes
	( <sup>mm</sup> / <sub>in</sub> ) D1		( <sup>bar</sup> / <sub>PSI</sub> ) D2	( <sup>mm</sup> / <sub>in</sub> ) L1	( <sup>mm</sup> / <sub>in</sub> ) L2	( <sup>mm</sup> / <sub>in</sub> ) S1		
S	6	800	3	30,3	33	17	4,21	FI-SNV-06S-V-W3-DKO-GLB
	.24	11600	.12	1.19	1.30	.67	9.28	FI-SNV-06S-V-W3-DKO
6	800	800	3	37	39,7	17	4,52	FI-SNV-06S-V-W3-DKO-GLA
	.24	11600	.12	1.46	1.56	.67	9.96	FI-SNV-06S-V-W3-DKO
6	800	800	3	37,8	40,5	17	0,46	FI-SNV-06S-V-W3-DKO-GLA
	.24	11600	.12	1.49	1.59	.67	1.01	FI-SNV-06S-V-W3-DKO
8	800	800	4	31,3	34	19	5,63	FI-SNV-08S-V-W3-DKO-GLB
	.31	11600	.16	1.23	1.34	.75	12.41	FI-SNV-08S-V-W3-DKO
8	800	800	4	37	39,7	19	6,03	FI-SNV-08S-V-W3-DKO-GLA
	.31	11600	.16	1.46	1.56	.75	13.29	FI-SNV-08S-V-W3-DKO
8	800	800	4	37,8	40,5	19	6,13	FI-SNV-08S-V-W3-DKO-GLA
	.31	11600	.16	1.49	1.59	.75	13.51	FI-SNV-08S-V-W3-DKO
10	800	800	6	32,2	35	22	7,63	FI-SNV-10S-V-W3-DKO-GLB
	.39	11600	.24	1.27	1.38	.87	16.82	FI-SNV-10S-V-W3-DKO
10	800	800	6	41	43,8	22	8,39	FI-SNV-10S-V-W3-DKO-GLA
	.39	11600	.24	1.61	1.72	.87	18.5	FI-SNV-10S-V-W3-DKO
12	630	630	8	35,2	38	24	6,52	FI-SNV-12S-V-W3-DKO-GLB
	.47	9135	.31	1.39	1.50	.94	14.37	FI-SNV-12S-V-W3-DKO
12	630	630	8	42	44,8	24	10,51	FI-SNV-12S-V-W3-DKO-GLA
	.47	9135	.31	1.65	1.76	.94	23.17	FI-SNV-12S-V-W3-DKO
14	630	630	9	37,2	41	27	2,9	FI-SNV-14S-V-W3-DKO-GLB
	.55	9135	.35	1.46	1.61	1.06	6.39	FI-SNV-14S-V-W3-DKO
14	630	630	9	45	48,8	27	13,9	FI-SNV-14S-V-W3-DKO-GLA
	.55	9135	.35	1.77	1.92	1.06	30.64	FI-SNV-14S-V-W3-DKO
16	630	630	10	37,2	42	30	16,09	FI-SNV-16S-V-W3-DKO-GLB
	.63	9135	.39	1.46	1.65	1.18	35.47	FI-SNV-16S-V-W3-DKO
16	630	630	10	46	50,8	30	17,57	FI-SNV-16S-V-W3-DKO-GLA
	.63	9135	.39	1.81	2.00	1.18	38.74	FI-SNV-16S-V-W3-DKO
20	420	420	13	42	48	36	26,3	FI-SNV-20S-V-W3-DKO-GLB
	.79	6091	.51	1.65	1.89	1.42	57.98	FI-SNV-20S-V-W3-DKO
20	420	420	13	55	61	36	24,36	FI-SNV-20S-V-W3-DKO-GLA
	.79	6091	.51	2.17	2.40	1.42	53.7	FI-SNV-20S-V-W3-DKO
25	420	420	18	45,5	54,4	46	45,05	FI-SNV-25S-V-W3-DKO-GLB
	.98	6091	.71	1.79	2.14	1.81	99.32	FI-SNV-25S-V-W3-DKO
25	420	420	18	56,5	65,4	46	50,1	FI-SNV-25S-V-W3-DKO-GLA
	.98	6091	.71	2.22	2.57	1.81	110.45	FI-SNV-25S-V-W3-DKO
25	420	420	18	58	67	46	49,45	FI-SNV-25S-V-W3-DKO-GLA
	.98	6091	.71	2.28	2.64	1.81	109.02	FI-SNV-25S-V-W3-DKO
30	420	420	20	50	62	50	57,2	FI-SNV-30S-V-W3-DKO-GLB
	1.18	6091	.79	1.97	2.44	1.97	126.1	FI-SNV-30S-V-W3-DKO
30	420	420	20	62	74	50	61,4	FI-SNV-30S-V-W3-DKO-GLA
	1.18	6091	.79	2.44	2.91	1.97	135.36	FI-SNV-30S-V-W3-DKO
38	420	420	30	50	67	60	74,2	FI-SNV-38S-V-W3-DKO-GLB
	1.50	6091	1.18	1.97	2.64	2.36	163.58	FI-SNV-38S-V-W3-DKO
38	420	420	30	67	84	60	86,7	FI-SNV-38S-V-W3-DKO-GLA
	1.50	6091	1.18	2.64	3.31	2.36	191.14	FI-SNV-38S-V-W3-DKO

Standard seal material is FKM (Viton®).

**Ordering Codes**
**\*FI-SNV\*-10\*S\*-V\*-W3\*-DKO**

- \* Straight Fitting with 24° Taper / O-Ring (DKO) FI-SNV
- \* Outside Tube Diameter D1 (in mm) -10
- \* Series Light Series (page 138) L  
Heavy Series (page 139) S
- \* Seal Material FKM (Viton®) -V  
EPDM -E
- \* Material Code Steel, zinc/nickel-plated -W3
- Please contact STAUFF for alternative materials and surface finishings.
- \* Assembling / Kitting Fitting body supplied with swivel nuts and O-rings -DKO
- \* Total length dimension see table -GLA  
dimension see table -GLB

**Spare Parts / Accessories**

 O-Ring  
Type **O-RING**

Page 239



**Straight Reducer with 24° Taper / O-Ring  
Type FI-SNV • Series L**

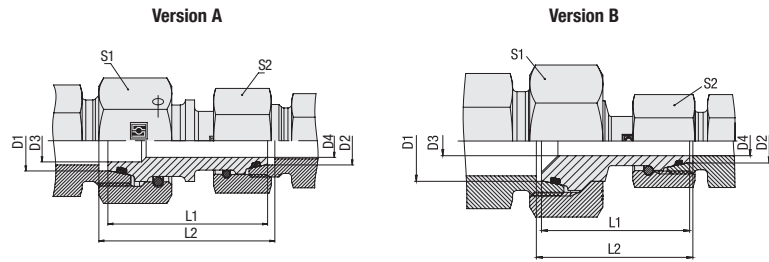

**Ordering Codes**

**\*FI-SNV\*-10/\*08\*L\*-V\*-W3\*-DKO**

- \* Straight Reducer with 24° Taper / O-Ring (DKO) **FI-SNV**
- \* Outside Tube Diameter D1 (in mm) **-10**
- \* Outside Tube Diameter D2 (in mm) **08**
- \* Series **L**  
 Light Series (pages 140/141)  
 Heavy Series (page 142) **S**
- \* Seal Material **-V**  
 FKM (Viton®)  
 EPDM **-E**
- \* Material Code **-W3**  
 Steel, zinc/nickel-plated
- Please contact STAUFF for alternative materials and surface finishings.
- \* Assembling / Kitting **-DKO**  
 Fitting body supplied with swivel nuts and O-rings
- \* Total length **-GLB**  
 dimension see table

**Spare Parts / Accessories**



O-Ring  
Type **O-RING**

Page 239

Series	Tube OD		PN (bar/psi)	Dimensions (mm/in)						Version	Weight (kg/lbs) Ca. per 100	Ordering Codes
	D1	D2		D3	D4	L1	L2	S1	S2			
L	8 L	6 L	500	3	3	34	36,7	17	14	A	4,72	FI-SNV-08/06L-V-W3-DKO
			7250	.12	.12	1.34	1.44	.67	.55		10.38	
	10 L	6 L	500	3	3	35	37,3	19	14	A	5,50	FI-SNV-10/06L-V-W3-DKO
			7250	.12	.12	1.38	1.47	.75	.55		12.10	
	10 L	8 L	500	5	5	35	37,3	19	17	A	5,21	FI-SNV-10/08L-V-W3-DKO
			7250	.20	.20	1.38	1.47	.75	.67		11.47	
	12 L	6 L	400	3	3	35	37,3	22	14	B	18,04	FI-SNV-12/06L-V-W3-DKO
			5800	.12	.12	1.38	1.47	.87	.55		39.68	
	12 L	8 L	400	5	5	36	38,3	22	17	B	6,22	FI-SNV-12/08L-V-W3-DKO
			5800	.20	.20	1.42	1.51	.87	.67		13.69	
	12 L	10 L	400	6,5	6,5	36,5	38,3	22	19	A	6,96	FI-SNV-12/10L-V-W3-DKO
			5800	.26	.26	1.44	1.51	.87	.75		15.31	
	12 L	12 S	400	8	8	39	41,3	24	22	B	9,42	FI-SNV-12L/12S-V-W3-DKO
			5800	.31	.31	1.54	1.63	.94	.87		20.77	
	15 L	8 L	400	5	5	36,5	38,8	27	17	B	1,96	FI-SNV-15/08L-V-W3-DKO
			5800	.20	.20	1.44	1.53	1.06	.67		4.30	
	15 L	10 L	400	6,5	6,5	37,5	39,3	27	19	B	4,40	FI-SNV-15/10L-V-W3-DKO
			5800	.26	.26	1.48	1.55	1.06	.75		9.69	
15 L	12 L	400	8	8	37	38,8	27	22	B	11,06	FI-SNV-15/12L-V-W3-DKO-GLB	
		5800	.31	.31	1.46	1.53	1.06	.87		24.38		
15 L	12 L	400	8	8	44	45,8	27	22	A	11,69	FI-SNV-15/12L-V-W3-DKO	
		5800	.31	.31	1.73	1.80	1.06	.87		25.73		
18 L	10 L	400	6,5	6,5	38	40,3	32	19	B	12,68	FI-SNV-18/10L-V-W3-DKO	
		5800	.26	.26	1.50	1.59	1.26	.75		27.89		
18 L	12 L	400	8	8	38	40,3	32	22	B	13,51	FI-SNV-18/12L-V-W3-DKO	
		5800	.31	.31	1.50	1.59	1.26	.87		29.72		
18 L	15 L	400	11	11	42,5	44,8	32	27	A	15,38	FI-SNV-18/15L-V-W3-DKO-GLB	
		5800	.43	.43	1.67	1.76	1.26	1.06		33.91		
18 L	15 L	400	11	11	45	47,3	32	27	A	16,60	FI-SNV-18/15L-V-W3-DKO	
		5800	.43	.43	1.77	1.86	1.26	1.06		36.51		
18 L	16 S	400	11	11	43,5	47,3	32	30	A	17,95	FI-SNV-18L/16S-V-W3-DKO	
		5800	.43	.43	1.71	1.86	1.26	1.18		39.57		

Standard seal material is FKM (Viton®).

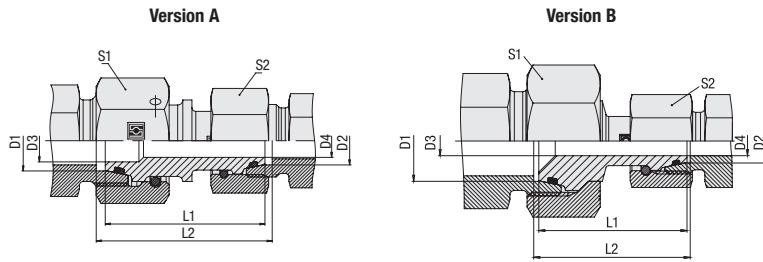

 Straight Reducer with 24° Taper / O-Ring  
 Type FI-SNV • Series L

Series	Tube OD (mm/in)		PN (bar/psi)	Dimensions (mm/in)						Version	Weight (kg/lbs) ca. per 100	Ordering Codes
	D1	D2		D3	D4	L1	L2	S1	S2			
L	22 L	12 L	250	8	8	40,5	42,8	36	22	B	17,52	FI-SNV-22/12L-V-W3-DKO
			3625	.31	.31	1.59	1.69	1.42	.87		38.55	
	22 L	15 L	250	11	11	42	44,3	36	27	B	19,83	FI-SNV-22/15L-V-W3-DKO
			3625	.43	.43	1.65	1.74	1.42	1.06		43.63	
	22 L	18 L	250	13	13	45	47,8	36	32	A	23,35	FI-SNV-22/18L-V-W3-DKO
			3625	.51	.51	1.77	1.88	1.42	1.26		51.37	
	22 L	20 S	250	14	14	50	54,4	36	32	A	27,82	FI-SNV-22L/20S-V-W3-DKO
			3625	.55	.55	1.97	2.14	1.42	1.26		61.33	
	28 L	15 L	250	11	11	43	45,3	41	27	B	23,86	FI-SNV-28/15L-V-W3-DKO
			3625	.43	.43	1.69	1.78	1.61	1.06		52.50	
	28 L	18 L	250	13	13	45	47,8	41	32	B	26,44	FI-SNV-28/18L-V-W3-DKO
			3625	.51	.51	1.77	1.88	1.61	1.26		58.16	
	28 L	22 L	250	17	17	46	48,8	41	36	B	28,93	FI-SNV-28/22L-V-W3-DKO
			3625	.67	.67	1.81	1.92	1.61	1.42		63.65	
	28 L	25 S	250	18	18	52,5	58,4	41	46	A	41,48	FI-SNV-28L/25S-V-W3-DKO
			3625	.71	.71	2.07	2.30	1.61	1.81		91.45	
	35 L	18 L	250	13	13	48	52,4	50	32	B	39,52	FI-SNV-35/18L-V-W3-DKO
			3625	.51	.51	1.89	2.06	1.97	1.26		86.94	
	35 L	22 L	250	17	17	49,5	53,9	50	36	B	41,34	FI-SNV-35/22L-V-W3-DKO
			3625	.67	.67	1.95	2.12	1.97	1.42		90.95	
35 L	28 L	250	23	23	50	54,4	50	41	B	40,71	FI-SNV-35/28L-V-W3-DKO	
		3625	.91	.91	1.97	2.14	1.97	1.61		89.57		
35 L	30 S	250	22	22	61	70	50	50	A	59,77	FI-SNV-35L/30S-V-W3-DKO	
		3625	.87	.87	2.40	2.76	1.97	1.97		131.77		
42 L	22 L	250	17	17	49,5	54,4	60	36	B	56,50	FI-SNV-42/22L-V-W3-DKO	
		3625	.67	.67	1.95	2.14	2.36	1.42		124.30		
42 L	28 L	250	23	23	50	54,9	60	41	B	56,10	FI-SNV-42/28L-V-W3-DKO	
		3625	.91	.91	1.97	2.16	2.36	1.61		123.42		
42 L	35 L	250	28	28	53	59,5	60	50	B	60,70	FI-SNV-42/35L-V-W3-DKO	
		3625	1.10	1.10	2.09	2.34	2.36	1.97		133.54		
42 L	38 S	250	30	30	55	67	60	60	A	78,2	FI-SNV-42L/38S-V-W3-DKO	
		3625	1.18	1.18	2.17	2.64	2.36	2.36		172.40		

Standard seal material is FKM (Viton®).

## Ordering Codes

**\*FI-SNV\*-10/\*08\*L\*-V\*-W3\*-DKO**

* Straight Reducer with 24° Taper / O-Ring (DKO)	<b>FI-SNV</b>
* Outside Tube Diameter D1 (in mm)	<b>-10</b>
* Outside Tube Diameter D2 (in mm)	<b>08</b>
* Series	Light Series (pages 140/141) <b>L</b> Heavy Series (page 142) <b>S</b>
* Seal Material	FKM (Viton®) <b>-V</b> EPDM <b>-E</b>
* Material Code	Steel, zinc/nickel-plated <b>-W3</b>

Please contact STAUFF for alternative materials and surface finishings.

* Assembling / Kitting	Fitting body supplied with swivel nuts and O-rings <b>-DKO</b>
------------------------	--

## Spare Parts / Accessories

 O-Ring  
 Type **O-RING**

Page 239



**Straight Reducer with 24° Taper / O-Ring  
Type FI-SNV ▪ Series S**

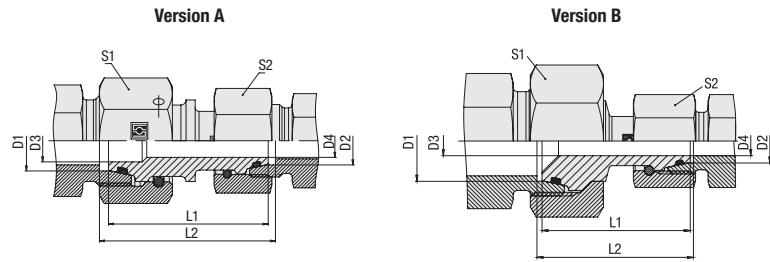

**Ordering Codes**

**\*FI-SNV\*-10/\*08\*S\*-V\*-W3\*-DKO**

- \* Straight Reducer with 24° Taper / O-Ring (DKO) **FI-SNV**
- \* Outside Tube Diameter D1 (in mm) **-10**
- \* Outside Tube Diameter D2 (in mm) **08**
- \* Series **L**  
Light Series (pages 140/141)  
**S**  
Heavy Series (page 142)
- \* Seal Material **-V**  
FKM (Viton®)  
**-E**  
EPDM
- \* Material Code **-W3**  
Steel, zinc/nickel-plated
- Please contact STAUFF for alternative materials and surface finishings.
- \* Assembling / Kitting **-DKO**  
Fitting body supplied with swivel nuts and O-rings
- \* Total length **-GLB**  
dimension see table

**Spare Parts / Accessories**



O-Ring  
Type **O-RING**

Page 239

Series	Tube OD (mm/in)		PN (bar/psi)	Dimensions (mm/in)						Version	Weight (kg/lbs) Ca. per 100	Ordering Codes
	D1	D2		D3	D4	L1	L2	S1	S2			
S	6S	6L	500	3	3	35,5	38,2	17	14	A	3,70	FI-SNV-06S/06L-V-W3-DKO
			7250	.12	.12	1.40	1.50	.67	.55	8.14		
	8 S	6S	800	3	3	37	39,7	19	17	A	5,43	FI-SNV-08/06S-V-W3-DKO
			11600	.12	.12	1.46	1.56	.75	.67	11.97		
	8 S	8 L	500	4	4	35,5	38,2	17	19	A	5,27	FI-SNV-08S/08L-V-W3-DKO
			7250	.16	.16	1.40	1.50	.67	.75	11.60		
	10 S	6 S	800	3	3	40,5	43,2	22	17	A	6,30	FI-SNV-10/06S-V-W3-DKO
			11600	.12	.12	1.59	1.70	.87	.67	13.86		
	10 S	8 S	800	4	4	39	41,7	22	19	A	7,60	FI-SNV-10/08S-V-W3-DKO
			11600	.16	.16	1.54	1.64	.87	.75	16.72		
	10 S	10 L	500	6,5	6,5	38,5	40,8	22	19	A	6,98	FI-SNV-10S/10L-V-W3-DKO
			7250	.26	.26	1.52	1.61	.87	.75	15.39		
	12 S	6 S	630	3	3	39	41,7	24	17	B	7,79	FI-SNV-12/06S-V-W3-DKO
			9135	.12	.12	1.54	1.64	.94	.67	17.13		
	12 S	8 S	630	4	4	44	46,7	24	19	A	9,42	FI-SNV-12/08S-V-W3-DKO
			9135	.16	.16	1.73	1.84	.94	.75	20.72		
	12 S	10 S	630	6,5	6,5	41,5	44,3	24	22	A	9,73	FI-SNV-12/10S-V-W3-DKO
			9135	.26	.26	1.63	1.74	.94	.87	21.40		
	16 S	10 S	630	6,5	6,5	43,5	47,3	30	22	B	14,11	FI-SNV-16/10S-V-W3-DKO
			9135	.26	.26	1.71	1.86	1.18	.87	31.03		
	16 S	12 S	630	8	8	47,5	51,3	30	24	A	15,32	FI-SNV-16/12S-V-W3-DKO
			9135	.31	.31	1.87	2.02	1.18	.94	33.70		
	16 S	15 L	400	11	11	42,5	45,8	30	27	A	14,66	FI-SNV-16S/15L-V-W3-DKO
			5800	.43	.43	1.67	1.80	1.18	1.06	32.32		
	20 S	12 S	400	8	8	48,5	52,9	36	24	B	21,90	FI-SNV-20/12S-V-W3-DKO
			5800	.31	.31	1.91	2.08	1.42	.94	48.18		
	20 S	16 S	400	11	11	52,5	57,9	36	30	A	24,68	FI-SNV-20/16S-V-W3-DKO
			5800	.43	.43	2.07	2.28	1.42	1.18	54.30		
	20 S	18 L	400	13	13	47,5	51,9	36	32	A	23,43	FI-SNV-20S/18L-V-W3-DKO
			5800	.51	.51	1.87	2.04	1.42	1.26	51.65		
	25 S	16 S	400	11	11	52	58,9	46	30	A	34,02	FI-SNV-25/16S-V-W3-DKO
			5800	.43	.43	2.05	2.32	1.81	1.18	74.84		
	25 S	18 L	400	13	13	41,5	47,5	46	32	B	36,2	FI-SNV-25S/18L-V-W3-DKO-GLB
			5800	.51	.51	1.63	1.87	1.81	1.26	79.81		
	25 S	18 L	400	13	13	50	56,3	46	32		38,4	FI-SNV-25S/18L-V-W3-DKO
			5800	.51	.51	1.97	2.22	1.81	1.26	84.66		
	25 S	20 S	400	14	14	58	65,5	46	36	A	39,77	FI-SNV-25/20S-V-W3-DKO
			5800	.55	.55	2.28	2.58	1.81	1.42	87.49		
	25 S	22 L	250	17	17	57	62,9	46	36	A	39,15	FI-SNV-25S/22L-V-W3-DKO
			3625	.67	.67	2.24	2.48	1.81	1.42	86.31		
	30 S	16 S	400	11	11	54	62,4	50	30	B	47,00	FI-SNV-30/16S-V-W3-DKO
			5800	.43	.43	2.13	2.46	1.97	1.18	103.40		
	30 S	20 S	400	14	14	58,5	67,5	50	36	B	51,00	FI-SNV-30/20S-V-W3-DKO
			5800	.55	.55	2.30	2.66	1.97	1.42	112.20		
	30 S	25 S	400	17	17	60	70,5	50	46	A	56,80	FI-SNV-30/25S-V-W3-DKO
			5800	.67	.67	2.36	2.78	1.97	1.81	124.96		
	30 S	28 L	250	22	22	59	66,4	50	41	A	45,5	FI-SNV-30S/28L-V-W3-DKO
			3625	.87	.87	2.32	2.61	1.97	1.61	100.31		
	38 S	20 S	400	14	14	61	72,5	60	36	B	71,30	FI-SNV-38/20S-V-W3-DKO
			5800	.55	.55	2.40	2.85	2.36	1.42	156.86		
	38 S	25 S	400	17	17	62,5	75,5	60	46	B	80,70	FI-SNV-38/25S-V-W3-DKO
			5800	.67	.67	2.46	2.97	2.36	1.81	177.54		
	38 S	30 S	400	22	22	64,5	79	60	50	A	76,90	FI-SNV-38/30S-V-W3-DKO
			5800	.87	.87	2.54	3.11	2.36	1.97	169.18		
	38 S	35 L	250	28	28	62	73,5	60	50	A	69,86	FI-SNV-38S/35L-V-W3-DKO
			3625	1.10	1.10	2.44	2.89	2.36	1.97	154.01		

Standard seal material is FKM (Viton®).



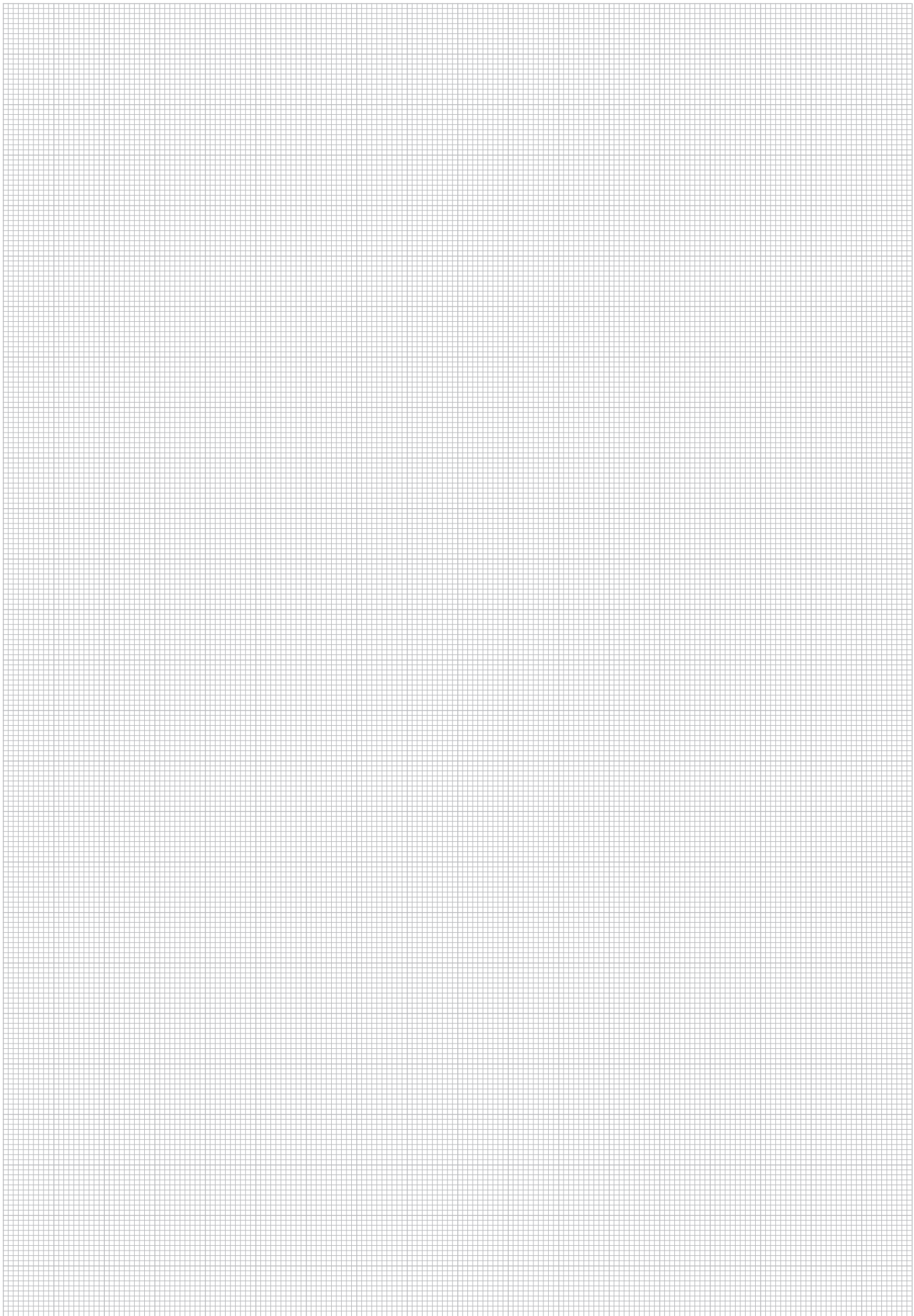

H





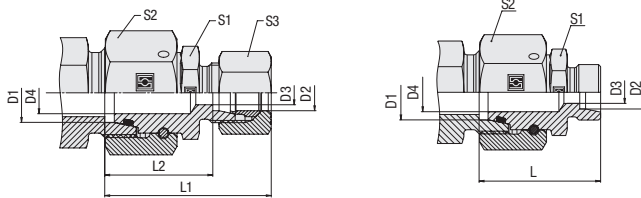

**Straight Reducer for Tube Ends with 24° Taper / O-Ring  
Type FI-RESDS - Series L**

Series	Tube OD (mm/in)		PN (bar/psi)	Dimensions (mm/in)							Weight (*10/lbs) ca. per 100	Ordering Codes <sup>3</sup>	
	D1	D2		D3	D4	L	L1 <sup>1</sup>	L2	S1	S2			S3
L	35	6	250	4	28	41	52	37	46	50	14	7,82	FI-RESDS-35/06L-V-W3-DKO
	1.38	.24	3625	.16	1.10	1.61	2.05	1.46	1.81	1.97	.55	17,20	
L	35	8	250	6	28	41	52	37	46	50	17	35,43	FI-RESDS-35/08L-V-W3-DKO
	1.38	.31	3625	.24	1.10	1.61	2.05	1.46	1.81	1.97	.67	77,95	
L	35	10	250	8	28	42	53	38	46	50	19	35,35	FI-RESDS-35/10L-V-W3-DKO
	1.38	.39	3625	.31	1.10	1.65	2.09	1.50	1.81	1.97	.75	77,77	
L	35	12	250	10	28	42	53	38	46	50	22	33,34	FI-RESDS-35/12L-V-W3-DKO
	1.38	.47	3625	.39	1.10	1.65	2.09	1.50	1.81	1.97	.87	73,34	
L	35	15	250	12	28	43	54	39	46	50	27	15,22	FI-RESDS-35/15L-V-W3-DKO
	1.38	.59	3625	.47	1.10	1.69	2.13	1.54	1.81	1.97	1.06	33,49	
L	35	18	250	15	28	44	55	39	46	50	32	34,32	FI-RESDS-35/18L-V-W3-DKO
	1.38	.71	3625	.59	1.10	1.73	2.17	1.54	1.81	1.97	1.26	75,50	
L	35	22	250	19	28	46	57	41	46	50	36	34,80	FI-RESDS-35/22L-V-W3-DKO
	1.38	.87	3625	.75	1.10	1.81	2.24	1.61	1.81	1.97	1.42	76,57	
L	35	28	250	24	24	46	57	41	46	50	41	38,10	FI-RESDS-35/28L-V-W3-DKO
	1.38	1.10	3625	.94	.94	1.81	2.24	1.61	1.81	1.97	1.61	83,82	
L	42	6	250	4	35	36	48	41	50	60	14	52,66	FI-RESDS-42/06L-V-W3-DKO
	1.65	.24	3625	.16	1.38	1.42	1.89	1.61	1.97	2.36	.55	115,85	
L	42	8	250	6	35	36	48	41	50	60	17	52,58	FI-RESDS-42/08L-V-W3-DKO
	1.65	.31	3625	.24	1.38	1.42	1.89	1.61	1.97	2.36	.67	115,67	
L	42	10	250	8	35	44	56	42	50	60	19	52,58	FI-RESDS-42/10L-V-W3-DKO
	1.65	.39	3625	.31	1.38	1.73	2.20	1.65	1.97	2.36	.75	115,68	
L	42	12	250	10	35	44	56	42	50	60	22	52,60	FI-RESDS-42/12L-V-W3-DKO
	1.65	.47	3625	.39	1.38	1.73	2.20	1.65	1.97	2.36	.87	115,72	
L	42	15	250	12	35	46	58	43	50	60	27	52,30	FI-RESDS-42/15L-V-W3-DKO
	1.65	.59	3625	.47	1.38	1.81	2.28	1.69	1.97	2.36	1.06	115,06	
L	42	18	250	15	35	46	58	42	50	60	32	52,00	FI-RESDS-42/18L-V-W3-DKO
	1.65	.71	3625	.59	1.38	1.81	2.28	1.65	1.97	2.36	1.26	114,40	
L	42	22	250	19	35	48	60	44	50	60	36	50,10	FI-RESDS-42/22L-V-W3-DKO
	1.65	.87	3625	.75	1.38	1.89	2.36	1.73	1.97	2.36	1.42	110,21	
L	42	28	250	24	35	49	61	44	50	60	41	50,19	FI-RESDS-42/28L-V-W3-DKO
	1.65	1.10	3625	.94	1.38	1.93	2.40	1.73	1.97	2.36	1.61	110,43	
L	42	35	250	30	30	53	65	43	50	60	50	55,90	FI-RESDS-42/35L-V-W3-DKO
	1.65	1.38	3625	1.18	1.18	2.09	2.56	1.69	1.97	2.36	1.97	122,98	

<sup>1</sup> Approximate dimension in assembled condition.

<sup>2</sup> Weight excluding cutting ring and union nut.

<sup>3</sup> Standard scope of delivery: Fitting body only.

Standard seal material is FKM (Viton®).

**Ordering Codes**
**\*FI-RESDS\*-10/\*08\*L\*-V\*-W3\*-DKO\*-MS**

- \* Straight Reducer for Tube Ends with 24° Taper / O-Ring (DKO) **FI-RESDS**
- \* Outside Tube Diameter D1 (in mm) **-10**
- \* Outside Tube Diameter D2 (in mm) **08**
- \* Series Light Series (pages 144/145) **L**  
Heavy Series (pages 146/147) **S**
- \* Seal Material FKM (Viton®) **-V**  
EPDM **-E**
- \* Material Code Steel, zinc/nickel-plated **-W3**

Please contact STAUFF for alternative materials and surface finishings.

- \* Assembling / Kitting Fitting body supplied with swivel nut and O-ring **-DKO**  
Fitting body supplied with cutting ring and union nut **-MS**  
Fitting body supplied with soft-sealing cutting ring and union nut **-MSV**

**Connecting Parts**

-  Cutting Ring Type **FI-DS** Page 28
-  Soft-Sealing Cutting Ring Type **FI-WDDS** Page 29
-  Support Sleeve Type **FI-VH** Page 31
-  STAUFF Form EVO Sealing Ring Type **FI-FD** Page 32
-  Union Nut Type **FI-M** Page 33
-  37° Flared Tube Fitting Set Type **FI-AB** Page 37

**Spare Parts / Accessories**

-  O-Ring Type **O-RING** Page 239



## Straight Reducer for Tube Ends with 24° Taper / O-Ring Type FI-RESDS • Series S

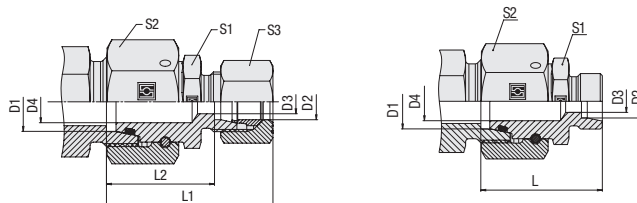

### Ordering Codes

**\*FI-RESDS\*-10/\*08\*S\*-V\*-W3\*-DKO\*-MS**

\* Straight Reducer for Tube Ends with 24° Taper / O-Ring (DKO) **FI-RESDS**

\* Outside Tube Diameter D1 (in mm) **-10**

\* Outside Tube Diameter D2 (in mm) **08**

\* Series Light Series (pages 144/145) **L**  
Heavy Series (pages 146/147) **S**

\* Seal Material FKM (Viton®) **-V**  
EPDM **-E**

\* Material Code Steel, zinc/nickel-plated **-W3**

Please contact STAUFF for alternative materials and surface finishings.

\* Assembling / Kitting Fitting body supplied with swivel nut and O-ring **-DKO**

Fitting body supplied with cutting ring and union nut **-MS**

Fitting body supplied with soft-sealing cutting ring and union nut **-MSV**

### Connecting Parts

	Cutting Ring Type <b>FI-DS</b>	Page 28
	Soft-Sealing Cutting Ring Type <b>FI-WDDS</b>	Page 29
	Support Sleeve Type <b>FI-VH</b>	Page 31
	STAUFF Form EVO Sealing Ring Type <b>FI-FD</b>	Page 32
	Union Nut Type <b>FI-M</b>	Page 33
	37° Flared Tube Fitting Set Type <b>FI-AB</b>	Page 37

Series	Tube OD (mm/in)		PN (bar/psi)	Dimensions (mm/in)									Weight (kg/lbs) ca. per 100	Ordering Codes <sup>3</sup>
	D1	D2		D3	D4	L	L <sup>1</sup>	L2	S1	S2	S3			
S	8	6	800	4	4	34	42	27	14	19	17	4,46	FI-RESDS-08/06S-V-W3-DKO	
	.31	.24	11600	.16	.16	1.34	1.65	1.06	.55	.75	.67	9.80	FI-RESDS-10/06S-V-W3-DKO	
	10	6	800	4	4	33	42	27,5	17	22	17	5,93	FI-RESDS-10/08S-V-W3-DKO	
	.39	.24	11600	.16	.16	1.30	1.65	1.08	.67	.87	.67	13.05	FI-RESDS-12/06S-V-W3-DKO	
	10	8	800	5	5	33	42	27,5	17	22	19	6,07	FI-RESDS-12/08S-V-W3-DKO	
	.39	.31	11600	.20	.20	1.30	1.65	1.08	.67	.87	.75	13.35	FI-RESDS-12/10S-V-W3-DKO	
	12	6	630	4	4	33	44	29	19	24	17	7,96	FI-RESDS-14/06S-V-W3-DKO	
	.47	.24	9135	.16	.16	1.30	1.73	1.14	.75	.94	.67	17.52	FI-RESDS-14/08S-V-W3-DKO	
	12	8	630	5	5	33	44	29	19	24	19	8,04	FI-RESDS-14/10S-V-W3-DKO	
	.47	.31	9135	.20	.20	1.30	1.73	1.14	.75	.94	.75	17.68	FI-RESDS-14/12S-V-W3-DKO	
	12	10	630	7	7	35	46	29,5	19	24	22	7,90	FI-RESDS-16/06S-V-W3-DKO	
	.47	.39	9135	.28	.28	1.38	1.81	1.16	.75	.94	.87	17.38	FI-RESDS-16/08S-V-W3-DKO	
	14	6	630	4	4	36	46	32	22	27	17	10,46	FI-RESDS-16/10S-V-W3-DKO	
	.55	.24	9135	.16	.16	1.42	1.81	1.26	.87	1.06	.67	23.02	FI-RESDS-16/12S-V-W3-DKO	
	14	8	630	5	5	36	46	32	22	27	19	10,53	FI-RESDS-16/14S-V-W3-DKO	
	.55	.31	9135	.20	.20	1.42	1.81	1.26	.87	1.06	.75	23.16	FI-RESDS-16/16S-V-W3-DKO	
	14	10	630	7	7	37	47	31	22	27	22	10,12	FI-RESDS-16/18S-V-W3-DKO	
	.55	.39	9135	.28	.28	1.46	1.85	1.22	.87	1.06	.87	22.27	FI-RESDS-20/06S-V-W3-DKO	
	14	12	630	8	8	37	47	31	22	27	24	10,44	FI-RESDS-20/08S-V-W3-DKO	
	.55	.47	9135	.31	.31	1.46	1.85	1.22	.87	1.06	.94	22.97	FI-RESDS-20/10S-V-W3-DKO	
	16	6	630	4	11	37	47	32	22	30	17	10,79	FI-RESDS-20/12S-V-W3-DKO	
	.63	.24	9135	.16	.43	1.46	1.85	1.26	.87	1.18	.67	23.74	FI-RESDS-20/14S-V-W3-DKO	
	16	8	630	5	11	37	47	32	22	30	19	11,04	FI-RESDS-20/16S-V-W3-DKO	
	.63	.31	9135	.20	.43	1.46	1.85	1.26	.87	1.18	.75	24.29	FI-RESDS-20/18S-V-W3-DKO	
16	10	630	7	7	38	48	31,5	22	30	22	7,67	FI-RESDS-20S/15L-V-W3-DKO		
.63	.39	9135	.28	.28	1.50	1.89	1.24	.87	1.18	.87	16.87	FI-RESDS-20S/18L-V-W3-DKO		
16	12	630	8	8	38	48	31,5	22	30	24	12,07	FI-RESDS-20S/20S-V-W3-DKO		
.63	.47	9135	.31	.31	1.50	1.89	1.24	.87	1.18	.94	26.55	FI-RESDS-20S/25S-V-W3-DKO		
16	14	630	10	10	41	51	33	24	30	27	12,64	FI-RESDS-20S/30S-V-W3-DKO		
.63	.55	9135	.39	.39	1.61	2.01	1.30	.94	1.18	1.06	27.80	FI-RESDS-20S/35S-V-W3-DKO		
S / L	16	15	400	11	11	40	47	32	24	30	27	11,66	FI-RESDS-20S/40S-V-W3-DKO	
.63	.59	5800	.43	.43	1.57	1.85	1.26	.94	1.18	1.06	25.71	FI-RESDS-20S/45S-V-W3-DKO		
20	6	420	4	14	40	51	36	27	36	17	17,16	FI-RESDS-20S/50S-V-W3-DKO		
.79	.24	6091	.16	.55	1.57	2.01	1.42	1.06	1.42	.67	37.75	FI-RESDS-20S/55S-V-W3-DKO		
20	8	420	5	14	40	51	36	27	36	19	17,61	FI-RESDS-20S/60S-V-W3-DKO		
.79	.31	6091	.20	.55	1.57	2.01	1.42	1.06	1.42	.75	38.74	FI-RESDS-20S/65S-V-W3-DKO		
20	10	420	7	14	41	52	35,5	27	36	22	17,49	FI-RESDS-20S/70S-V-W3-DKO		
.79	.39	6091	.28	.55	1.61	2.05	1.40	1.06	1.42	.87	38.48	FI-RESDS-20S/75S-V-W3-DKO		
20	12	420	8	14	41	52	35,5	27	36	24	17,76	FI-RESDS-20S/80S-V-W3-DKO		
.79	.47	6091	.31	.55	1.61	2.05	1.40	1.06	1.42	.94	39.08	FI-RESDS-20S/85S-V-W3-DKO		
20	14	420	10	14	44	55	37	27	36	27	19,83	FI-RESDS-20S/90S-V-W3-DKO		
.79	.55	6091	.39	.55	1.73	2.17	1.46	1.06	1.42	1.06	43.62	FI-RESDS-20S/95S-V-W3-DKO		
S / L	20	15	400	12	12	43	51	35	27	36	30	18,38	FI-RESDS-20S/100S-V-W3-DKO	
.79	.59	5800	.47	.47	1.69	2.01	1.38	1.06	1.42	1.18	40.52	FI-RESDS-20S/105S-V-W3-DKO		
20	16	420	12	12	44	55	36,5	27	36	30	19,34	FI-RESDS-20S/110S-V-W3-DKO		
.79	.63	6091	.47	.47	1.73	2.17	1.44	1.06	1.42	1.18	42.56	FI-RESDS-20S/115S-V-W3-DKO		
S / L	20	18	400	14	14	43	54	35	27	36	32	18,10	FI-RESDS-20S/120S-V-W3-DKO	
.79	.71	5800	.55	.55	1.69	2.13	1.38	1.06	1.42	1.26	39.90	FI-RESDS-20S/125S-V-W3-DKO		

### Spare Parts / Accessories

	O-Ring Type <b>O-RING</b>	Page 239
--	------------------------------	----------

<sup>1</sup> Approximate dimension in assembled condition.

<sup>2</sup> Weight excluding cutting ring and union nut.

<sup>3</sup> Standard scope of delivery: Fitting body only.

Standard seal material is FKM (Viton®).

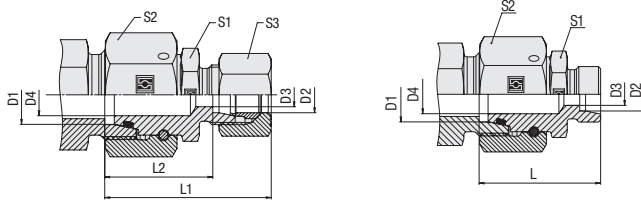

**Straight Reducer for Tube Ends with 24° Taper / O-Ring  
Type FI-RESDS • Series S**

Series	Tube OD (mm/in)		PN (bar/psi)	Dimensions (mm/in)									Weight (*10/100) ca.	Ordering Codes <sup>3</sup>
	D1	D2		D3	D4	L	L1 <sup>1</sup>	L2	S1	S2	S3			
S	25	6	420	4	18	41	53	38,5	36	46	17	29,87	FI-RESDS-25/06S-V-W3-DKO	
	.98	.24	6091	.16	.71	1.61	2.09	1.52	1.42	1.81	.67	65.72		
	25	8	420	5	18	41	53	38,5	36	46	19	30,39	FI-RESDS-25/08S-V-W3-DKO	
	.98	.31	6091	.20	.71	1.61	2.09	1.52	1.42	1.81	.75	66.85		
	25	10	420	7	18	42	54	38	36	46	22	16,95	FI-RESDS-25/10S-V-W3-DKO	
	.98	.39	6091	.28	.71	1.65	2.13	1.50	1.42	1.81	.87	37.29		
	25	12	420	8	18	42	54	38	36	46	24	30,41	FI-RESDS-25/12S-V-W3-DKO	
	.98	.47	6091	.31	.71	1.65	2.13	1.50	1.42	1.81	.94	66.91		
	25	14	420	10	18	45	57	40	36	46	27	30,95	FI-RESDS-25/14S-V-W3-DKO	
	.98	.55	6091	.39	.71	1.77	2.24	1.57	1.42	1.81	1.06	68.09		
	25	16	420	12	18	45	57	39	36	46	30	30,29	FI-RESDS-25/16S-V-W3-DKO	
	.98	.63	6091	.47	.71	1.77	2.24	1.54	1.42	1.81	1.18	66.65		
S / L	25	18	400	15	18	45	53	37	36	46	32	30,54	FI-RESDS-25S/18L-V-W3-DKO	
	.98	.71	5800	.59	.71	1.77	2.09	1.46	1.42	1.81	1.26	67.33		
	25	20	420	16	16	49	61	39	36	46	36	32,97	FI-RESDS-25/20S-V-W3-DKO	
	.98	.79	6091	.63	.63	1.93	2.40	1.54	1.42	1.81	1.42	72.53		
	30	6	420	4	22	46	59	44	41	50	17	37,93	FI-RESDS-30/06S-V-W3-DKO	
	1.18	.24	6091	.16	.87	1.81	2.32	1.73	1.61	1.97	.67	83.45		
	30	8	420	5	22	46	59	44	41	50	19	31,17	FI-RESDS-30/08S-V-W3-DKO	
	1.18	.31	6091	.20	.87	1.81	2.32	1.73	1.61	1.97	.75	68.57		
	30	10	420	7	22	47	60	43,5	41	50	22	38,28	FI-RESDS-30/10S-V-W3-DKO	
	1.18	.39	6091	.28	.87	1.85	2.36	1.71	1.61	1.97	.87	84.22		
	30	12	420	8	22	47	60	43,5	41	50	24	38,65	FI-RESDS-30/12S-V-W3-DKO	
	1.18	.47	6091	.31	.87	1.85	2.36	1.71	1.61	1.97	.94	85.03		
	30	14	420	10	22	50	63	45	41	50	27	38,88	FI-RESDS-30/14S-V-W3-DKO	
	1.18	.55	6091	.39	.87	1.97	2.48	1.77	1.61	1.97	1.06	85.53		
	30	16	420	12	22	50	63	44,5	41	50	30	38,59	FI-RESDS-30/16S-V-W3-DKO	
	1.18	.63	6091	.47	.87	1.97	2.48	1.75	1.61	1.97	1.18	84.89		
	30	20	420	16	22	53	66	44,5	41	50	36	39,86	FI-RESDS-30/20S-V-W3-DKO	
	1.18	.79	6091	.63	.87	2.09	2.60	1.75	1.61	1.97	1.42	87.69		
	30	25	420	20	20	56	69	45	41	50	46	42,96	FI-RESDS-30/25S-V-W3-DKO	
	1.18	.98	6091	.79	.79	2.20	2.72	1.77	1.61	1.97	1.81	94.51		
	38	6	420	4	30	47	62	47,5	50	60	17	55,50	FI-RESDS-38/06S-V-W3-DKO	
	1.50	.24	6091	.16	1.18	1.85	2.44	1.87	1.97	2.36	.67	122.10		
	38	8	420	5	30	47	62	47,5	50	60	19	55,50	FI-RESDS-38/08S-V-W3-DKO	
	1.50	.31	6091	.20	1.18	1.85	2.44	1.87	1.97	2.36	.75	122.10		
38	10	420	7	30	48	63	47	50	60	22	56,40	FI-RESDS-38/10S-V-W3-DKO		
1.50	.39	6091	.28	1.18	1.89	2.48	1.85	1.97	2.36	.87	124.08			
38	12	420	8	30	48	63	47	50	60	24	55,50	FI-RESDS-38/12S-V-W3-DKO		
1.50	.47	6091	.31	1.18	1.89	2.48	1.85	1.97	2.36	.94	122.10			
38	14	420	10	30	51	66	49	50	60	27	62,87	FI-RESDS-38/14S-V-W3-DKO		
1.50	.55	6091	.39	1.18	2.01	2.60	1.93	1.97	2.36	1.06	138.32			
38	16	420	12	30	51	66	48	50	60	30	55,80	FI-RESDS-38/16S-V-W3-DKO		
1.50	.63	6091	.47	1.18	2.01	2.60	1.89	1.97	2.36	1.18	122.76			
38	20	420	16	30	55	70	48	50	60	36	57,40	FI-RESDS-38/20S-V-W3-DKO		
1.50	.79	6091	.63	1.18	2.17	2.76	1.89	1.97	2.36	1.42	126.28			
38	25	420	20	30	58	73	48,5	50	60	46	59,30	FI-RESDS-38/25S-V-W3-DKO		
1.50	.98	6091	.79	1.18	2.28	2.87	1.91	1.97	2.36	1.81	130.46			
38	30	420	25	25	61	76	49	50	60	50	63,70	FI-RESDS-38/30S-V-W3-DKO		
1.50	1.18	6091	.98	.98	2.40	2.99	1.93	1.97	2.36	1.97	140.14			

**Ordering Codes**
**\*FI-RESDS\*-10/\*08\*S\*-V\*-W3\*-DKO\*-MS**

- \* Straight Reducer for Tube Ends with 24° Taper / O-Ring (DKO) **FI-RESDS**
- \* Outside Tube Diameter D1 (in mm) **-10**
- \* Outside Tube Diameter D2 (in mm) **08**
- \* Series Light Series (pages 144/145) **L**  
Heavy Series (pages 146/147) **S**
- \* Seal Material FKM (Viton®) **-V**  
EPDM **-E**
- \* Material Code Steel, zinc/nickel-plated **-W3**

- Please contact STAUFF for alternative materials and surface finishings.
- \* Assembling / Kitting Fitting body supplied with swivel nut and O-ring **-DKO**  
Fitting body supplied with cutting ring and union nut **-MS**  
Fitting body supplied with soft-sealing cutting ring and union nut **-MSV**

**Connecting Parts**

- Cutting Ring Type **FI-DS** Page 28
- Soft-Sealing Cutting Ring Type **FI-WDDS** Page 29
- Support Sleeve Type **FI-VH** Page 31
- STAUFF Form EVO Sealing Ring Type **FI-FD** Page 32
- Union Nut Type **FI-M** Page 33
- 37° Flared Tube Fitting Set Type **FI-AB** Page 37

**Spare Parts / Accessories**

- O-Ring Type **O-RING** Page 239

<sup>1</sup> Approximate dimension in assembled condition.  
<sup>2</sup> Weight excluding cutting ring and union nut.  
<sup>3</sup> Standard scope of delivery: Fitting body only.

Standard seal material is FKM (Viton®).



Distance Adaptors with 24° Taper / O-Ring  
Type FI-RESDS • Series L / S

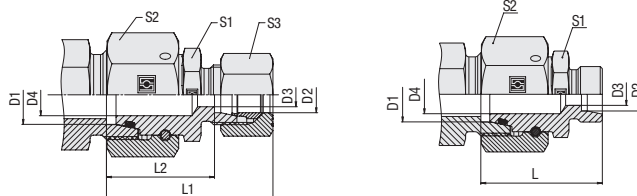

Ordering Codes

**\*FI-RESDS\*-08\*L\*-V\*-W3\*-DKO\*-MS**

\* Distance Adaptors with 24° Taper / O-Ring (DKO) **FI-RESDS**

\* Outside Tube Diameter D1/D2 (in mm) **-08**

\* Series Light Series **L**  
Heavy Series **S**

\* Seal Material FKM (Viton®) **-V**  
EPDM **-E**

\* Material Code Steel, zinc/nickel-plated **-W3**

Please contact STAUFF for alternative materials and surface finishings.

\* Assembling / Kitting Fitting body supplied with swivel nut and O-ring **-DKO**

Fitting body supplied with cutting ring and union nut **-MS**

Fitting body supplied with soft-sealing cutting ring and union nut **-MSV**

Connecting Parts

-  Cutting Ring Type **FI-DS** Page 28
-  Soft-Sealing Cutting Ring Type **FI-WDDS** Page 29
-  Support Sleeve Type **FI-VH** Page 31
-  STAUFF Form EVO Sealing Ring Type **FI-FD** Page 32
-  Union Nut Type **FI-M** Page 33
-  37° Flared Tube Fitting Set Type **FI-AB** Page 37

Spare Parts / Accessories

-  O-Ring Type **O-RING** Page 239

Series	Tube OD (mm/in)		PN (bar/psi)	Dimensions (mm/in)									Weight (kg/lbs) ca. per 100	Ordering Codes <sup>3</sup>
	D1	D2		D3	D4	L	L1 <sup>1</sup>	L2	S1	S2	S3			
L	6	6	500	3	3	43	52	36	12	14	14	4,33	FI-RESDS-06L-V-W3-DKO	
	.24	.24	7250	.12	.12	1.69	2.05	1.42	.47	.55	.55	9.55		
	8	8	500	5	5	43	51	36	14	17	17	4,63	FI-RESDS-08L-V-W3-DKO	
	.31	.31	7250	.2	.2	1.69	2.01	1.42	.55	.67	.67	10.21		
	10	10	500	6,5	6,5	44	51	37	17	19	19	6,15	FI-RESDS-10L-V-W3-DKO	
	.39	.39	7250	.26	.26	1.73	2.01	1.46	.67	.75	.75	13.56		
	12	12	400	8	8	43,5	52	36,5	19	22	22	7,85	FI-RESDS-12L-V-W3-DKO	
	.47	.47	5800	.31	.31	1.71	2.05	1.44	.75	.87	.87	17.31		
	15	15	400	11	11	38	55	38	24	27	27	12,05	FI-RESDS-15L-V-W3-DKO	
	.59	.59	5800	.43	.43	1.50	2.17	1.50	.94	1.06	1.06	26.57		
	18	18	400	13	13	43	53	36	27	32	32	15,61	FI-RESDS-18L-V-W3-DKO	
	.71	.71	5800	.51	.51	1.69	2.09	1.42	1.06	1.26	1.26	34.41		
	22	22	250	17	17	50	59	42	32	36	36	21,63	FI-RESDS-22L-V-W3-DKO	
	.87	.87	3625	.67	.67	1.97	2.32	1.65	1.26	1.42	1.42	47.69		
	28	28	250	23	23	51	61	43	41	41	41	27,45	FI-RESDS-28L-V-W3-DKO	
	1.10	1.10	3625	.91	.91	2.01	2.40	1.69	1.61	1.61	1.61	60.52		
	35	35	250	24	24	62	74	51	46	50	50	53,4	FI-RESDS-35L-V-W3-DKO	
	1.38	1.38	3625	.94	.94	2.44	2.91	2.01	1.81	1.97	1.97	117.73		
42	42	250	35	35	72	83	61	55	60	60	77,7	FI-RESDS-42L-V-W3-DKO		
1.65	1.65	3625	1.38	1.38	2.83	3.27	2.40	2.17	2.36	2.36	171.3			
S	6	6	800	3	3	44	50	37	14	17	17	4,91	FI-RESDS-06S-V-W3-DKO	
	.24	.24	11600	.12	.12	1.73	1.97	1.46	.55	.67	.67	10.82		
	8	8	800	4	4	44	51	37	17	19	19	6,64	FI-RESDS-08S-V-W3-DKO	
	.31	.31	11600	.16	.16	1.73	2.01	1.46	.67	.75	.75	14.64		
	10	10	800	6,5	6,5	44	52	36	19	22	22	8,18	FI-RESDS-10S-V-W3-DKO	
	.39	.39	11600	.26	.26	1.73	2.05	1.42	.75	.87	.87	18.03		
	12	12	630	8	8	45	54	38	22	24	24	10,28	FI-RESDS-12S-V-W3-DKO	
	.47	.47	9135	.31	.31	1.77	2.13	1.50	.87	.94	.94	22.66		
	14	14	630	9	9	49	58	41	24	27	27	13,75	FI-RESDS-14S-V-W3-DKO	
	.55	.55	9135	.35	.35	1.93	2.28	1.61	.94	1.06	1.06	30.31		
	16	16	630	11	11	49	58	41	27	30	30	16,53	FI-RESDS-16S-V-W3-DKO	
	.63	.63	9135	.43	.43	1.93	2.28	1.61	1.06	1.18	1.18	36.44		
	20	20	420	14	14	56	67	46	32	36	36	26,97	FI-RESDS-20S-V-W3-DKO	
	.79	.79	6091	.55	.55	2.20	2.64	1.81	1.26	1.42	1.42	59.46		
	25	25	420	18	18	61	73	49	41	46	46	46,37	FI-RESDS-25S-V-W3-DKO	
	.98	.98	6091	.71	.71	2.40	2.87	1.93	1.61	1.81	1.81	102.23		
	30	30	420	22	22	67	80	54	46	50	50	60	FI-RESDS-30S-V-W3-DKO	
	1.18	1.18	6091	.87	.87	2.64	3.15	2.13	1.81	1.97	1.97	132.28		
38	38	420	32	32	72	87	56	55	60	60	82,5	FI-RESDS-38S-V-W3-DKO		
1.50	1.50	6091	1.26	1.26	2.83	3.43	2.20	2.17	2.36	2.36	181.88			

<sup>1</sup> Approximate dimension in assembled condition.

<sup>2</sup> Weight excluding cutting ring and union nut.

<sup>3</sup> Standard scope of delivery: Fitting body only.

Standard seal material is FKM (Viton®).



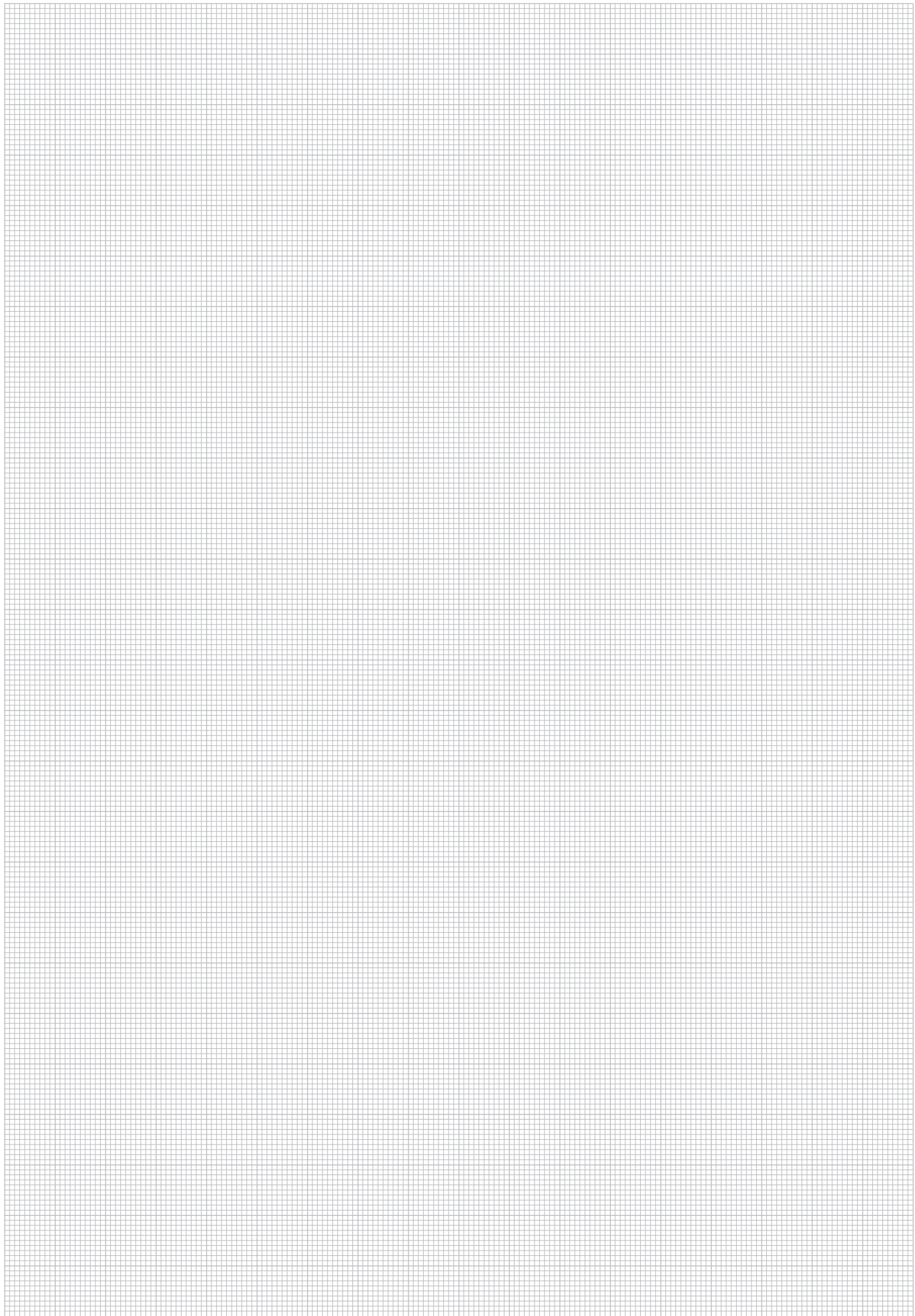

H



**Adjustable Elbow (90°) with 24° Taper / O-Ring**  
**Type FI-EWD ▪ Series L / S**

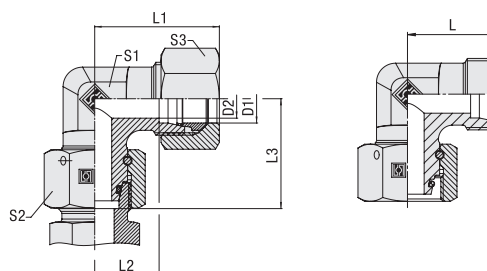

**Ordering Codes**

**\*FI-EWD\*-10\*L\*-V\*-W3\*-DKO\*-MS**

\* Adjustable Elbow (90°) with 24° Taper / O-Ring (DKO) **FI-EWD**

\* Outside Tube Diameter D1 (in mm) **-10**

\* Series Light Series **L**  
 Heavy Series **S**

\* Seal Material FKM (Viton®) **-V**  
 EPDM **-E**

\* Material Code Steel, zinc/nickel-plated **-W3**

Please contact STAUFF for alternative materials and surface finishings.

\* Assembling / Kitting Fitting body supplied with swivel nut and O-ring **-DKO**

Fitting body supplied with cutting ring and union nut **-MS**

Fitting body supplied with soft-sealing cutting ring and union nut **-MSV**

**Connecting Parts**

Cutting Ring  
 Type **FI-DS** Page 28

Soft-Sealing Cutting Ring  
 Type **FI-WDDS** Page 29

Support Sleeve  
 Type **FI-VH** Page 31

STAUFF Form EVO Sealing Ring  
 Type **FI-FD** Page 32

Union Nut  
 Type **FI-M** Page 33

37° Flared Tube Fitting Set  
 Type **FI-AB** Page 37

**Spare Parts / Accessories**

O-Ring  
 Type **O-RING** Page 239

Series	Tube OD (mm/in)	PN (bar/psi)	Dimensions (mm/in)							Weight (kg/lbs) ca. per 100	Ordering Codes <sup>3</sup>	
			D1	D2	L	L1 <sup>1</sup>	L2	L3	S1			S2
L	6	500	4	19	27	12	26	12	14	14	4,00	FI-EWD-06L-V-W3-DKO
	.24	7250	.16	.75	1.06	.47	1.02	.47	.55	.55	8.81	
	8	500	6	21	29	14	27,5	12	17	17	4,03	FI-EWD-08L-V-W3-DKO
	.31	7250	.24	.83	1.14	.55	1.08	.47	.67	.67	8.86	
	10	500	8	22	30	15	29	14	19	19	5,36	FI-EWD-10L-V-W3-DKO
	.39	7250	.31	.87	1.18	.59	1.14	.55	.75	.75	11.78	
	12	400	10	24	32	17	29,5	17	22	22	7,60	FI-EWD-12L-V-W3-DKO
	.47	5800	.39	.94	1.26	.67	1.16	.67	.87	.87	16.72	
	15	400	12	28	36	21	32,5	19	27	27	12,50	FI-EWD-15L-V-W3-DKO
	.59	5800	.47	1.10	1.42	.83	1.28	.75	1.06	1.06	27.50	
	18	400	15	31	40	23,5	35,5	24	32	32	18,23	FI-EWD-18L-V-W3-DKO
	.71	5800	.59	1.22	1.57	.93	1.40	.94	1.26	1.26	40.11	
	22	400	19	35	44	27,5	38,5	27	36	36	24,57	FI-EWD-22L-V-W3-DKO
	.87	5800	.75	1.38	1.73	1.08	1.52	1.06	1.42	1.42	54.05	
	28	250	24	38	47	30,5	41,5	36	41	41	34,95	FI-EWD-28L-V-W3-DKO
	1.10	3625	.94	1.50	1.85	1.20	1.63	1.42	1.61	1.61	76.89	
	35	250	30	45	56	34,5	51	41	50	50	56,50	FI-EWD-35L-V-W3-DKO
	1.38	3625	1.18	1.77	2.20	1.36	2.01	1.61	1.97	1.97	124.30	
42	250	36	51	63	40	56	50	60	60	85,10	FI-EWD-42L-V-W3-DKO	
1.65	3625	1.42	2.01	2.48	1.57	2.20	1.97	2.36	2.36	187.22		
S	6	800	4	23	31	16	27	12	17	17	4,67	FI-EWD-06S-V-W3-DKO
	.24	11600	.16	.91	1.22	.63	1.06	.47	.67	.67	10.27	
	8	800	5	24	32	17	27,5	14	19	19	6,29	FI-EWD-08S-V-W3-DKO
	.31	11600	.20	.94	1.26	.67	1.08	.55	.75	.75	13.84	
	10	800	7	25	34	17,5	30	17	22	22	8,58	FI-EWD-10S-V-W3-DKO
	.39	11600	.28	.98	1.34	.69	1.18	.67	.87	.87	18.87	
	12	630	8	29	38	21,5	31	17	24	24	11,02	FI-EWD-12S-V-W3-DKO
	.47	9135	.31	1.14	1.50	.85	1.22	.67	.94	.94	24.24	
	14	630	10	30	40	22	35	19	27	27	14,34	FI-EWD-14S-V-W3-DKO
	.55	9135	.39	1.18	1.57	.87	1.38	.75	1.06	1.06	31.54	
	16	630	12	33	43	24,5	36,5	24	30	30	19,26	FI-EWD-16S-V-W3-DKO
	.63	9135	.47	1.30	1.69	.96	1.44	.94	1.18	1.18	42.38	
	20	420	16	37	48	26,5	44,5	27	36	36	29,86	FI-EWD-20S-V-W3-DKO
	.79	6091	.63	1.46	1.89	1.04	1.75	1.06	1.42	1.42	65.70	
	25	420	20	42	54	30	50	36	46	46	53,20	FI-EWD-25S-V-W3-DKO
	.98	6091	.79	1.65	2.13	1.18	1.97	1.42	1.81	1.81	117.04	
	30	420	25	49	62	35,5	55	41	50	50	72,50	FI-EWD-30S-V-W3-DKO
	1.18	6091	.98	1.93	2.44	1.40	2.17	1.61	1.97	1.97	159.50	
38	420	32	57	72	41	63	50	60	60	109,40	FI-EWD-38S-V-W3-DKO	
1.50	6091	1.26	2.24	2.83	1.61	2.48	1.97	2.36	2.36	240.68		

<sup>1</sup> Approximate dimension in assembled condition.

<sup>2</sup> Weight excluding cutting ring and union nut.

<sup>3</sup> Standard scope of delivery: Fitting body only.

Standard seal material is FKM (Viton®).



Typical application with a Straight Male Stud Fitting FI-GE-...

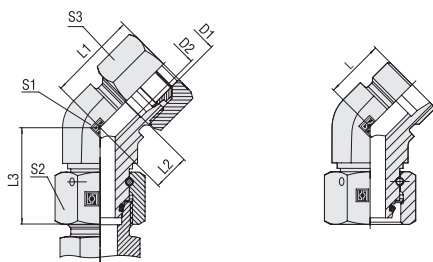

**Adjustable Elbow (45°) with 24° Taper / O-Ring  
Type FI-EVD • Series L / S**

Series	Tube OD		Dimensions									Weight (*9/10) ca. per 100	Ordering Codes <sup>3</sup>
	(mm/in)	PN (bar/PSI)	(mm/in)	L	L1 <sup>1</sup>	L2	L3	S1	S2	S3			
L	6	500	4	16	24	9	26	14	14	14	4,63	FI-EVD-06L-V-W3-DKO	
	.24	7250	.16	.63	.94	.35	1.02	.55	.55	.55	10.19		
	8	500	6	19	27	12	27,5	14	17	17	4,72	FI-EVD-08L-V-W3-DKO	
	.31	7250	.24	.75	1.06	.47	1.08	.55	.67	.67	10.37		
	10	500	8	19	27	12	29	19	19	19	7,56	FI-EVD-10L-V-W3-DKO	
	.39	7250	.31	.75	1.06	.47	1.14	.75	.75	.75	16.63		
	12	400	10	21	29	14	29,5	19	22	22	8,66	FI-EVD-12L-V-W3-DKO	
	.47	5800	.39	.83	1.14	.55	1.16	.75	.87	.87	19.06		
	15	400	12	24	32	17	32,5	22	27	27	12,96	FI-EVD-15L-V-W3-DKO	
	.59	5800	.47	.94	1.26	.67	1.28	.87	1.06	1.06	28.52		
	18	400	15	24	33	17	35,5	27	32	32	20,64	FI-EVD-18L-V-W3-DKO	
	.71	5800	.59	.94	1.30	.67	1.40	1.06	1.26	1.26	45.42		
	22	400	19	26	35	19	38,5	30	36	36	26,41	FI-EVD-22L-V-W3-DKO	
	.87	5800	.75	1.02	1.38	.75	1.52	1.18	1.42	1.42	58.11		
	28	250	24	30,5	40	23	41,5	36	41	41	34,69	FI-EVD-28L-V-W3-DKO	
	1.10	3625	.94	1.20	1.57	.91	1.63	1.42	1.61	1.61	76.32		
	35	250	30	37	48	27	51	50	50	50	79,60	FI-EVD-35L-V-W3-DKO	
	1.38	3625	1.18	1.46	1.89	1.06	2.01	1.97	1.97	1.97	175.12		
42	250	36	37	49	26	56	50	60	60	83,20	FI-EVD-42L-V-W3-DKO		
1.65	3625	1.42	1.46	1.93	1.02	2.20	1.97	2.36	2.36	183.04			
S	6	630	4	16	24	9	27	14	17	17	4,90	FI-EVD-06S-V-W3-DKO	
	.24	9135	.16	.63	.94	.35	1.06	.55	.67	.67	10.77		
	8	630	5	19	27	12	27,5	19	19	19	5,17	FI-EVD-08S-V-W3-DKO	
	.31	9135	.20	.75	1.06	.47	1.08	.75	.75	.75	11.37		
	10	630	7	21	30	13	30	19	22	22	9,44	FI-EVD-10S-V-W3-DKO	
	.39	9135	.28	.83	1.18	.51	1.18	.75	.87	.87	20.76		
	12	630	8	24	33	17	31	19	24	24	12,90	FI-EVD-12S-V-W3-DKO	
	.47	9135	.31	.94	1.30	.67	1.22	.75	.94	.94	28.38		
	14	400	10	24	34	16	33,5	22	27	27	14,4	FI-EVD-14S-V-W3-DKO	
	.55	5800	.39	.94	1.34	.63	1.32	.87	1.06	1.06	31.68		
	16	400	12	24	34	16	36,5	19	30	30	16,76	FI-EVD-16S-V-W3-DKO	
	.63	5800	.47	.94	1.34	.63	1.44	.75	1.18	1.18	36.87		
	20	400	16	26,5	37,5	16	44,5	27	36	36	30,72	FI-EVD-20S-V-W3-DKO	
	.79	5800	.63	1.04	1.48	.63	1.75	1.06	1.42	1.42	67.58		
	25	400	20	30,5	42,5	19	50	36	46	46	50,10	FI-EVD-25S-V-W3-DKO	
	.98	5800	.79	1.20	1.67	.75	1.97	1.42	1.81	1.81	110.22		
	30	400	25	37	50	24	55	50	50	50	92,90	FI-EVD-30S-V-W3-DKO	
	1.18	5800	.98	1.46	1.97	.94	2.17	1.97	1.97	1.97	204.38		
38	315	32	37	52	21	63	50	60	60	98,50	FI-EVD-38S-V-W3-DKO		
1.50	4568	1.26	1.46	2.05	.83	2.48	1.97	2.36	2.36	216.70			

### Ordering Codes

**\*FI-EVD\*-10\*L\*-V\*-W3\*-DKO\*-MS**

- \* Adjustable Elbow (45°) with 24° Taper / O-Ring (DKO) **FI-EVD**
- \* Outside Tube Diameter D1 (in mm) **-10**
- \* Series Light Series **L**  
Heavy Series **S**
- \* Seal Material FKM (Viton®) **-V**  
EPDM **-E**
- \* Material Code Steel, zinc/nickel-plated **-W3**

Please contact STAUFF for alternative materials and surface finishings.

- \* Assembling / Kitting Fitting body supplied with swivel nut and O-ring **-DKO**  
Fitting body supplied with cutting ring and union nut **-MS**  
Fitting body supplied with soft-sealing cutting ring and union nut **-MSV**

### Connecting Parts

- Cutting Ring Type **FI-DS** Page 28
- Soft-Sealing Cutting Ring Type **FI-WDDS** Page 29
- Support Sleeve Type **FI-VH** Page 31
- STAUFF Form EVO Sealing Ring Type **FI-FD** Page 32
- Union Nut Type **FI-M** Page 33
- 37° Flared Tube Fitting Set Type **FI-AB** Page 37

### Spare Parts / Accessories

- O-Ring Type **O-RING** Page 239

<sup>1</sup> Approximate dimension in assembled condition.  
<sup>2</sup> Weight excluding cutting ring and union nut.  
<sup>3</sup> Standard scope of delivery: Fitting body only.



Standard seal material is FKM (Viton®).

**Adjustable Branch Tee with 24° Taper / O-Ring (DKO)**  
**Type FI-ETD ▪ Series L / S**

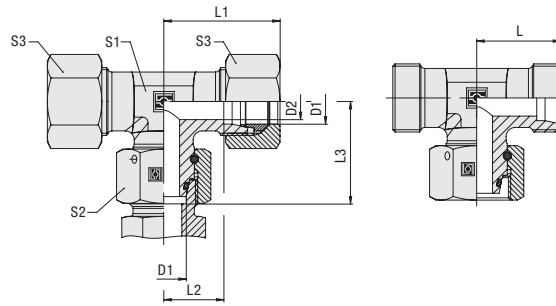

**Ordering Codes**

**\*FI-ETD\*-10\*L\*-V\*-W3\*-DKO\*-MS**

- \* Adjustable Branch Tee with 24° Taper / O-Ring (DKO) **FI-ETD**
- \* Outside Tube Diameter D1 (in mm) **-10**
- \* Series **L**  
 Light Series **L**  
 Heavy Series **S**
- \* Seal Material **-V**  
 FKM (Viton®) **-E**  
 EPDM
- \* Material Code **-W3**  
 Steel, zinc/nickel-plated
- Please contact STAUFF for alternative materials and surface finishings.
- \* Assembling / Kitting **-DKO**  
 Fitting body supplied with swivel nut and O-ring
- MS**  
 Fitting body supplied with cutting ring and union nut
- MSV**  
 Fitting body supplied with soft-sealing cutting ring and union nut

**Connecting Parts**

- Cutting Ring  
Type **FI-DS** Page 28
- Soft-Sealing Cutting Ring  
Type **FI-WDDS** Page 29
- Support Sleeve  
Type **FI-VH** Page 31
- STAUFF Form EVO Sealing Ring  
Type **FI-FD** Page 32
- Union Nut  
Type **FI-M** Page 33
- 37° Flared Tube Fitting Set  
Type **FI-AB** Page 37

**Spare Parts / Accessories**

- O-Ring  
Type **O-RING** Page 239

Series	Tube OD (mm/in)	PN (bar/psi)	Dimensions (mm/in)							Weight (kg/lbs) ca. per 100	Ordering Codes <sup>3</sup>	
			D1	D2	L	L1 <sup>1</sup>	L2	L3	S1			S2
L	6	500	4	19	27	12	26	12	14	14	3,02	FI-ETD-06L-V-W3-DKO
	.24	7250	.16	.75	1.06	.47	1.02	.47	.55	.55	6,64	
	8	500	6	21	29	14	27,5	12	17	17	4,82	FI-ETD-08L-V-W3-DKO
	.31	7250	.24	.83	1.14	.55	1.08	.47	.67	.67	10,61	
	10	500	8	22	30	15	29	14	19	19	6,27	FI-ETD-10L-V-W3-DKO
	.39	7250	.31	.87	1.18	.59	1.14	.55	.75	.75	13,79	
	12	400	10	24	32	17	29,5	17	22	22	8,73	FI-ETD-12L-V-W3-DKO
	.47	5800	.39	.94	1.26	.67	1.16	.67	.87	.87	19,21	
	15	400	12	28	36	21	32,5	19	27	27	14,55	FI-ETD-15L-V-W3-DKO
	.59	5800	.47	1.10	1.42	.83	1.28	.75	1.06	1.06	32,01	
	18	400	15	31	40	23,5	35,5	24	32	32	20,89	FI-ETD-18L-V-W3-DKO
	.71	5800	.59	1.22	1.57	.93	1.40	.94	1.26	1.26	45,95	
	22	400	19	35	44	27,5	38,5	27	36	36	28,27	FI-ETD-22L-V-W3-DKO
	.87	5800	.75	1.38	1.73	1.08	1.52	1.06	1.42	1.42	62,20	
	28	250	24	38	47	30,5	41,5	36	41	41	39,85	FI-ETD-28L-V-W3-DKO
	1.10	3625	.94	1.50	1.85	1.20	1.63	1.42	1.61	1.61	87,67	
	35	250	30	45	56	34,5	51	41	50	50	64,20	FI-ETD-35L-V-W3-DKO
	1.38	3625	1.18	1.77	2.20	1.36	2.01	1.61	1.97	1.97	141,24	
42	250	36	51	63	40	56	50	60	60	94,90	FI-ETD-42L-V-W3-DKO	
1.65	3625	1.42	2.01	2.48	1.57	2.20	1.97	2.36	2.36	208,78		
S	6	800	4	23	31	16	27	12	17	17	5,99	FI-ETD-06S-V-W3-DKO
	.24	11600	.16	.91	1.22	.63	1.06	.47	.67	.67	13,18	
	8	800	5	24	32	17	27,5	14	19	19	7,80	FI-ETD-08S-V-W3-DKO
	.31	11600	.20	.94	1.26	.67	1.08	.55	.75	.75	17,15	
	10	800	7	25	34	17,5	30	17	22	22	10,60	FI-ETD-10S-V-W3-DKO
	.39	11600	.28	.98	1.34	.69	1.18	.67	.87	.87	23,32	
	12	630	8	29	38	21,5	31	17	24	24	13,63	FI-ETD-12S-V-W3-DKO
	.47	9135	.31	1.14	1.50	.85	1.22	.67	.94	.94	29,98	
	14	630	10	30	40	22	35	19	27	27	17,37	FI-ETD-14S-V-W3-DKO
	.55	9135	.39	1.18	1.57	.87	1.38	.75	1.06	1.06	38,21	
	16	630	12	33	43	24,5	36,5	24	30	30	22,95	FI-ETD-16S-V-W3-DKO
	.63	9135	.47	1.30	1.69	.96	1.44	.94	1.18	1.18	50,49	
	20	420	16	37	48	26,5	44,5	27	36	36	35,51	FI-ETD-20S-V-W3-DKO
	.79	6091	.63	1.46	1.89	1.04	1.75	1.06	1.42	1.42	78,13	
	25	420	20	42	54	30	50	36	46	46	62,40	FI-ETD-25S-V-W3-DKO
	.98	6091	.79	1.65	2.13	1.18	1.97	1.42	1.81	1.81	137,28	
	30	420	25	49	62	35,5	55	41	50	50	85,60	FI-ETD-30S-V-W3-DKO
	1.18	6091	.98	1.93	2.44	1.40	2.17	1.61	1.97	1.97	188,32	
38	420	32	57	72	41	63	50	60	60	128,10	FI-ETD-38S-V-W3-DKO	
1.50	6091	1.26	2.24	2.83	1.61	2.48	1.97	2.36	2.36	281,82		

<sup>1</sup> Approximate dimension in assembled condition.  
<sup>2</sup> Weight excluding cutting ring and union nut.  
<sup>3</sup> Standard scope of delivery: Fitting body only.



Typical application with a Straight Male Stud Fitting FI-GE-...

Standard seal material is FKM (Viton®).



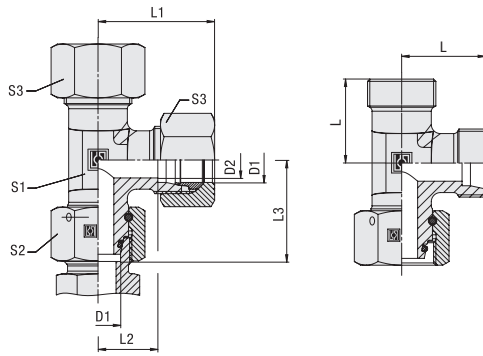

**Adjustable Barrel Tee with 24° Taper / O-Ring (DKO)  
Type FI-ELD • Series L / S**

Series	Tube OD		PN		Dimensions							Weight (*9/10s) ca. per 100	Ordering Codes <sup>3</sup>
	(mm/in)	(mm/in)	(bar/PSI)	(mm/in)	D1	D2	L	L <sup>1</sup>	L2	L3	S1		
L	6	500	4	19	27	12	26	12	14	14	4,79	FI-ELD-06L-V-W3-DKO	
	.24	7250	.16	.75	1.06	.47	1.02	.47	.55	.55	10.53	FI-ELD-06L-V-W3-DKO	
	8	500	6	21	29	14	27,5	12	17	17	4,88	FI-ELD-08L-V-W3-DKO	
	.31	7250	.24	.83	1.14	.55	1.08	.47	.67	.67	10.74	FI-ELD-08L-V-W3-DKO	
	10	500	8	22	30	15	29	14	19	19	6,45	FI-ELD-10L-V-W3-DKO	
	.39	7250	.31	.87	1.18	.59	1.14	.55	.75	.75	14.19	FI-ELD-10L-V-W3-DKO	
	12	400	10	24	32	17	29,5	17	22	22	8,58	FI-ELD-12L-V-W3-DKO	
	.47	5800	.39	.94	1.26	.67	1.16	.67	.87	.87	18.88	FI-ELD-12L-V-W3-DKO	
	15	400	12	28	36	21	32,5	19	27	27	14,60	FI-ELD-15L-V-W3-DKO	
	.59	5800	.47	1.10	1.42	.83	1.28	.75	1.06	1.06	32.12	FI-ELD-15L-V-W3-DKO	
	18	400	15	31	40	23,5	35,5	24	32	32	20,83	FI-ELD-18L-V-W3-DKO	
	.71	5800	.59	1.22	1.57	.93	1.40	.94	1.26	1.26	45.82	FI-ELD-18L-V-W3-DKO	
	22	400	19	35	44	27,5	38,5	27	36	36	28,02	FI-ELD-22L-V-W3-DKO	
	.87	5800	.75	1.38	1.73	1.08	1.52	1.06	1.42	1.42	61.64	FI-ELD-22L-V-W3-DKO	
	28	250	24	38	47	30,5	41,5	36	41	41	39,66	FI-ELD-28L-V-W3-DKO	
	1.10	3625	.94	1.50	1.85	1.20	1.63	1.42	1.61	1.61	87.25	FI-ELD-28L-V-W3-DKO	
	35	250	30	45	56	34,5	51	41	50	50	64,60	FI-ELD-35L-V-W3-DKO	
	1.38	3625	1.18	1.77	2.20	1.36	2.01	1.61	1.97	1.97	142.12	FI-ELD-35L-V-W3-DKO	
	42	250	36	51	63	40	56	50	60	60	94,70	FI-ELD-42L-V-W3-DKO	
	1.65	3625	1.42	2.01	2.48	1.57	2.20	1.97	2.36	2.36	208.34	FI-ELD-42L-V-W3-DKO	
S	6	800	4	23	31	16	27	12	17	17	6,04	FI-ELD-06S-V-W3-DKO	
	.24	11600	.16	.91	1.22	.63	1.06	.47	.67	.67	13.30	FI-ELD-06S-V-W3-DKO	
	8	800	5	24	32	17	27,5	14	19	19	8,14	FI-ELD-08S-V-W3-DKO	
	.31	11600	.20	.94	1.26	.67	1.08	.55	.75	.75	17.90	FI-ELD-08S-V-W3-DKO	
	10	800	7	25	34	17,5	30	17	22	22	10,53	FI-ELD-10S-V-W3-DKO	
	.39	11600	.28	.98	1.34	.69	1.18	.67	.87	.87	23.16	FI-ELD-10S-V-W3-DKO	
	12	630	8	29	38	21,5	31	17	24	24	13,80	FI-ELD-12S-V-W3-DKO	
	.47	9135	.31	1.14	1.50	.85	1.22	.67	.94	.94	30.36	FI-ELD-12S-V-W3-DKO	
	14	630	10	30	40	22	35	19	27	27	20,27	FI-ELD-14S-V-W3-DKO	
	.55	9135	.39	1.18	1.57	.87	1.38	.75	1.06	1.06	44.59	FI-ELD-14S-V-W3-DKO	
	16	630	12	33	43	24,5	36,5	24	30	30	23,13	FI-ELD-16S-V-W3-DKO	
	.63	9135	.47	1.30	1.69	.96	1.44	.94	1.18	1.18	50.88	FI-ELD-16S-V-W3-DKO	
	20	420	16	37	48	26,5	44,5	27	36	36	35,53	FI-ELD-20S-V-W3-DKO	
	.79	6091	.63	1.46	1.89	1.04	1.75	1.06	1.42	1.42	78.17	FI-ELD-20S-V-W3-DKO	
	25	420	20	42	54	30	50	36	46	46	61,90	FI-ELD-25S-V-W3-DKO	
.98	6091	.79	1.65	2.13	1.18	1.97	1.42	1.81	1.81	136.18	FI-ELD-25S-V-W3-DKO		
30	420	25	49	62	35,5	55	41	50	50	85,10	FI-ELD-30S-V-W3-DKO		
1.18	6091	.98	1.93	2.44	1.40	2.17	1.61	1.97	1.97	187.22	FI-ELD-30S-V-W3-DKO		
38	420	32	57	72	41	63	50	60	60	128,00	FI-ELD-38S-V-W3-DKO		
1.50	6091	1.26	2.24	2.83	1.61	2.48	1.97	2.36	2.36	281.60	FI-ELD-38S-V-W3-DKO		

<sup>1</sup> Approximate dimension in assembled condition.  
<sup>2</sup> Weight excluding cutting ring and union nut.  
<sup>3</sup> Standard scope of delivery: Fitting body only.



Typical application with a  
Straight Male Stud Fitting FI-GE...

Standard seal material is FKM (Viton®).

**Ordering Codes**
**\*FI-ELD\*-10\*L\*-V\*-W3\*-DKO\*-MS**

- \* Adjustable Barrel Tee with 24° Taper / O-Ring (DKO) FI-ELD
  - \* Outside Tube Diameter D1 (in mm) -10
  - \* Series L  
S
  - \* Seal Material FKM (Viton®) -V  
EPDM -E
  - \* Material Code Steel, zinc/nickel-plated -W3
- Please contact STAUFF for alternative materials and surface finishings.
- \* Assembling / Kitting Fitting body supplied with swivel nut and O-ring -DKO  
Fitting body supplied with cutting ring and union nut -MS  
Fitting body supplied with soft-sealing cutting ring and union nut -MSV

**Connecting Parts**







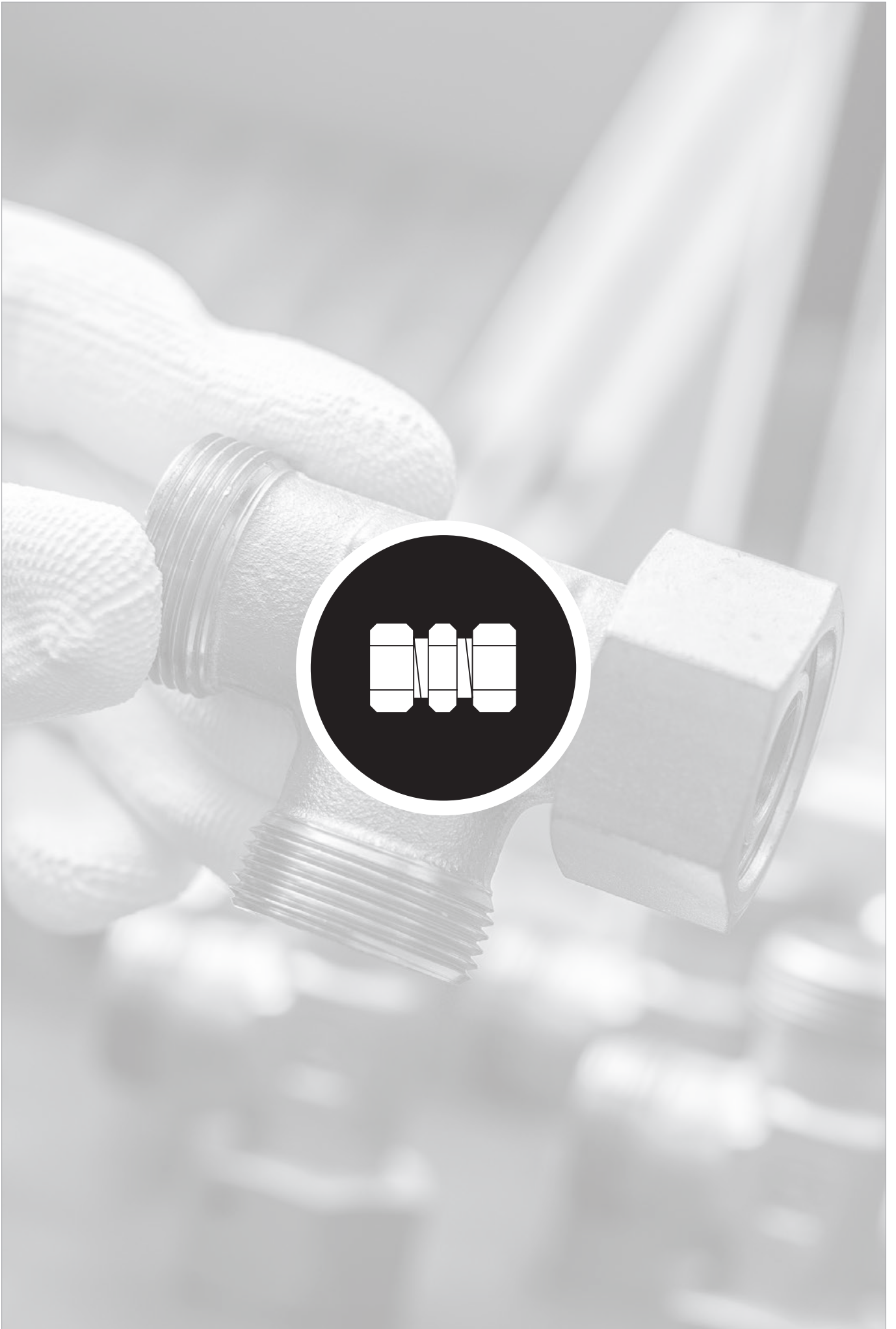

-  Cutting Ring  
Type **FI-DS** Page 28
-  Soft-Sealing Cutting Ring  
Type **FI-WDDS** Page 29
-  Support Sleeve  
Type **FI-VH** Page 31
-  STAUFF Form EVO Sealing Ring  
Type **FI-FD** Page 32
-  Union Nut  
Type **FI-M** Page 33
-  37° Flared Tube Fitting Set  
Type **FI-AB** Page 37

**Spare Parts / Accessories**

-  O-Ring  
Type **O-RING** Page 239





	<b>Straight Male Stud Standpipe Fitting</b>	<b>156-161</b>
	FI-EGE	
	<b>Whitworth Parallel Pipe Thread (BSPP) / Metallic Sealing Edge</b>	<b>156</b>
	FI-EGE-...-R	
	<b>Metric Parallel Thread / Metallic Sealing Edge</b>	<b>157</b>
	FI-EGE-...-M	
	<b>Whitworth Parallel Pipe Thread (BSPP) / Profile Sealing Ring</b>	<b>158</b>
	FI-EGE-...-R-WD	
	<b>Metric Parallel Thread / Profile Sealing Ring</b>	<b>160</b>
	FI-EGE-...-M-WD	
	<b>NPT Thread</b>	<b>161</b>
	FI-EGE-...-N	
	<b>Straight Standpipe Reducer</b>	<b>162</b>
	FI-REDS	
	<b>Adjustable Standpipe Elbow</b>	<b>166</b>
	FI-EW	
	<b>Adjustable Standpipe Branch Tee</b>	<b>167</b>
	FI-ET	
	<b>Adjustable Standpipe Barrel Tee</b>	<b>168</b>
	FI-EL	

**Straight Male Stud Standpipe Fitting**  
**Type FI-EGE-...-R • Series L / S**

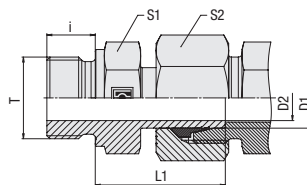

**Ordering Codes**

**\*FI-EGE\*-10\*L\*R\*-W3\*-SV**

- \* Straight Male Stud Standpipe Fitting **FI-EGE**
- \* Outside Tube Diameter D1 (in mm) **-10**
- \* Series **L**  
 Light Series  
**S**  
 Heavy Series
- \* Thread Type **R**  
 Whitworth Parallel  
 Pipe Thread (BSPP)
- If required, please indicate special sizes, e.g. R1/8!
- \* Material Code **-W3**  
 Steel, zinc/nickel-plated
- Please contact STAUFF for alternative materials and surface finishings.
- \* Assembling / Kitting **-SV**  
 Fitting body assembled with cutting ring and union nut on the standpipe

**Whitworth Parallel Pipe Thread (BSPP)**

**Metallic Sealing Edge**

Series	Tube OD		PN (PB)	Dimensions					Torque	Weight	Ordering Codes <sup>2</sup>
	(mm/in)	(mm/in)		(mm/in)	(mm/in)	(mm/in)	(mm/in)	(mm/in)			
	D1	Thread T		D2	L1	i	S1	S2	Thread T	per 100 <sup>1</sup>	
L	6	400	G 1/8	3,5	24,5	8	14	14	25	2,50	FI-EGE-06LR-W3-SV
	.24	5800		.14	.96	.31	.55	.55	18.4	5.50	
	8	400	G 1/4	4,5	29,5	12	19	17	55	5,53	FI-EGE-08LR-W3-SV
	.31	5800		.18	1.16	.47	.75	.67	40.7	12.17	
	10	400	G 1/4	7	27,5	12	19	19	55	5,11	FI-EGE-10LR-W3-SV
	.39	5800		.28	1.08	.47	.75	.75	40.7	11.23	
	12	400	G 3/8	7,5	34	12	22	22	95	8,25	FI-EGE-12LR-W3-SV
	.47	5800		.30	1.34	.47	.87	.87	70.1	18.15	
	15	400	G 1/2	11	32	14	27	27	185	13,02	FI-EGE-15LR-W3-SV
	.59	5800		.43	1.26	.55	1.06	1.06	136.5	28.65	
	18	400	G 1/2	14	31,5	14	27	32	185	13,86	FI-EGE-18LR-W3-SV
	.71	5800		.55	1.24	.55	1.06	1.26	136.5	30.48	
	22	250	G 3/4	18	32,5	16	32	36	250	19,98	FI-EGE-22LR-W3-SV
	.87	3625		.71	1.28	.63	1.26	1.42	184.4	43.96	
	28	250	G 1	23	35	18	41	41	400	27,39	FI-EGE-28LR-W3-SV
	1.10	3625		.91	1.38	.71	1.61	1.61	295	60.26	
	35	250	G 1 1/4	29,5	42,5	20	50	50	670	47,03	FI-EGE-35LR-W3-SV
	1.38	3625		1.16	1.67	.79	1.97	1.97	494.2	103.47	
42	250	G 1 1/2	35,5	46,5	22	55	60	800	72,00	FI-EGE-42LR-W3-SV	
1.65	3625		1.40	1.83	.87	2.17	2.36	590	158.40		
S	6	PB630	G 1/4	3,5	27	12	19	17	80	4,98	FI-EGE-06SR-W3-SV
	.24	PB9135		.14	1.06	.47	.75	.67	59	10.96	
	8	PB630	G 1/4	4,5	29,5	12	19	19	80	5,98	FI-EGE-08SR-W3-SV
	.31	PB9135		.18	1.16	.47	.75	.75	59	13.16	
	10	PB630	G 3/8	6,5	32	12	22	22	130	8,81	FI-EGE-10SR-W3-SV
	.39	PB9135		.26	1.26	.47	.87	.87	95.9	19.39	
	12	PB630	G 3/8	7,5	34	12	22	24	130	10,01	FI-EGE-12SR-W3-SV
	.47	PB9135		.30	1.34	.47	.87	.94	95.9	22.01	
	14	PB630	G 1/2	9,5	36,5	14	27	27	220	13,95	FI-EGE-14SR-W3-SV
	.55	PB9135		.37	1.44	.55	1.06	1.06	162.3	30.69	
	16	PB400	G 1/2	11,5	37	14	27	30	220	16,94	FI-EGE-16SR-W3-SV
	.63	PB5800		.45	1.46	.55	1.06	1.18	162.3	37.28	
	20	PB400	G 3/4	15,5	43	16	32	36	350	26,98	FI-EGE-20SR-W3-SV
	.79	PB5800		.61	1.69	.63	1.26	1.42	258.1	59.36	
	25	PB400	G 1	18	48	18	41	46	700	49,03	FI-EGE-25SR-W3-SV
	.98	PB5800		.71	1.89	.71	1.61	1.81	518	107.87	
	30	PB400	G 1 1/4	23,5	51	20	50	50	850	69,13	FI-EGE-30SR-W3-SV
	1.18	PB5800		.93	2.01	.79	1.97	1.97	627	152.08	
38	PB250	G 1 1/2	29	60	22	55	60	1000	98,20	FI-EGE-38SR-W3-SV	
1.50	PB3625		1.14	2.36	.87	2.17	2.36	737.5	216.04		

<sup>1</sup>Weight including cutting ring and union nut on the standpipe.

<sup>2</sup>Standard scope of delivery: Fitting body assembled with cutting ring and union nut on the standpipe.

Please note: Standpipes are always factory-assembled with cutting rings and union nuts.

The union nut assembled on the standpipe has to be tightened by only 1/12 a turn (equivalent to 30°) beyond the fixed point.

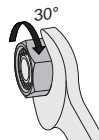

Male stud acc. to DIN 3852-2 (Form B) / ISO 1179-4 (Type B)  
 Port acc. to DIN 3852-2 (Form X) / ISO 1179-1

Torque recommendations for Steel mating material.

Male threaded studs were designed for female threaded ports in components made of steel. For applications with components made of softer mating materials (e.g. Aluminium), the use of connectors with additionally rolled male threads is recommended. Please contact STAUFF prior to the assembly for further information.

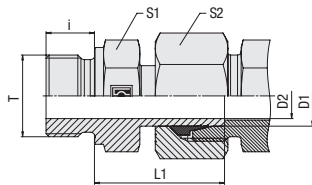

**Straight Male Stud Standpipe Fitting  
Type FI-EGE-...-M • Series L / S**

**Metallic Sealing Edge**
**Metric Parallel Thread**

Series	Tube OD		PN (PB) (bar/PSI)	Dimensions			Torque (N-m/ft-lb)	Weight (kg/lbs) ca. per 100 <sup>1</sup>	Ordering Codes <sup>2</sup>		
	(mm/in)	(mm/in)		Thread T	D2	L1				i	S1
L	6	315	M 10 x 1	3,5	24,5	8	14	14	950	2,54	FI-EGE-06LM-W3-SV
	.24	4568		.14	.96	.31	.55	.55	700.7	5.59	
	8	315	M 12 x 1,5	5,5	26,5	12	17	17	35	4,34	FI-EGE-08LM-W3-SV
	.31	4568		.22	1.04	.47	.67	.67	25.8	9.55	
	10	315	M 14 x 1,5	7	27,5	12	19	19	55	5,29	FI-EGE-10LM-W3-SV
	.39	4568		.28	1.08	.47	.75	.75	40.5	11.63	
	12	315	M 16 x 1,5	9	30,5	12	22	22	80	7,95	FI-EGE-12LM-W3-SV
	.47	4568		.35	1.24	.47	.87	.87	59.2	17.48	
	15	315	M 18 x 1,5	11	31,5	12	24	27	100	10,25	FI-EGE-15LM-W3-SV
	.59	4568		.43	1.24	.47	.94	1.06	73.7	22.55	
	18	315	M 22 x 1,5	14	31,5	14	27	32	170	14,82	FI-EGE-18LM-W3-SV
	.71	4568		.55	1.24	.55	1.06	1.26	125.8	32.60	
	22	160	M 26 x 1,5	18	32,5	16	32	36	230	19,57	FI-EGE-22LM-W3-SV
	.87	2320		.71	1.28	.63	1.26	1.42	169.6	43.06	
	28	160	M 33 x 2	23	35	18	41	41	400	28,94	FI-EGE-28LM-W3-SV
	1.10	2320		.91	1.38	.71	1.61	1.61	295	63.67	
	35	160	M 42 x 2	29,5	42,5	20	50	50	700	47,56	FI-EGE-35LM-W3-SV
	1.38	2320		1.16	1.67	.79	1.97	1.97	518	104.63	
	42	160	M 48 x 2	35,5	46,5	22	55	60	900	67,00	FI-EGE-42LM-W3-SV
	1.65	2320		1.40	1.83	.87	2.17	2.36	663.8	147.40	
S	6	PB630	M 12 x 1,5	3,5	27	12	17	17	60	4,51	FI-EGE-06SM-W3-SV
	.24	PB9135		.14	1.06	.47	.67	.67	44.2	9.92	
	8	PB630	M 14 x 1,5	4,5	29,5	12	19	19	90	6,30	FI-EGE-08SM-W3-SV
	.31	PB9135		.18	1.16	.47	.75	.75	66.4	13.85	
	10	PB630	M 16 x 1,5	6,5	32	12	22	22	120	8,79	FI-EGE-10SM-W3-SV
	.39	PB9135		.26	1.26	.47	.87	.87	88.5	19.33	
	12	PB630	M 18 x 1,5	7,5	34	12	24	24	190	11,24	FI-EGE-12SM-W3-SV
	.47	PB9135		.30	1.34	.47	.94	.94	140.1	24.73	
	14	PB630	M 20 x 1,5	9,5	36,5	14	27	27	280	15,53	FI-EGE-14SM-W3-SV
	.55	PB9135		.37	1.44	.55	1.06	1.06	206.5	34.17	
	16	PB400	M 22 x 1,5	11,5	37	14	27	30	300	17,47	FI-EGE-16SM-W3-SV
	.63	PB5800		.45	1.46	.55	1.06	1.18	221.2	38.43	
	20	PB400	M 27 x 2	15,5	43	16	32	36	420	27,28	FI-EGE-20SM-W3-SV
	.79	PB5800		.61	1.69	.63	1.26	1.42	309.8	60.02	
	25	PB400	M 33 x 2	18	48	18	41	46	600	51,00	FI-EGE-25SM-W3-SV
	.98	PB5800		.71	1.89	.71	1.61	1.81	442.5	112.20	
	30	PB400	M 42 x 2	23,5	51	20	50	50	700	69,54	FI-EGE-30SM-W3-SV
	1.18	PB5800		.93	2.01	.79	1.97	1.97	518	152.98	
	38	PB315	M 48 x 2	29	60	22	55	60	900	99,38	FI-EGE-38SM-W3-SV
	1.50	PB4568		1.14	2.36	.87	2.17	2.36	663.8	218.64	

**Ordering Codes**
**\*FI-EGE\*-10\*L\*M\*-W3\*-SV**

- \* Straight Male Stud Standpipe Fitting **FI-EGE**
- \* Outside Tube Diameter D1 (in mm) **-10**
- \* Series **L**  
Light Series **L**  
Heavy Series **S**
- \* Thread Type **M**  
Metric Parallel Thread **M**
- If required, please indicate special sizes, e.g. M12x1.5!
- \* Material Code **-W3**  
Steel, zinc/nickel-plated **-W3**
- Please contact STAUFF for alternative materials and surface finishings.
- \* Assembling / Kitting **-SV**  
Fitting body assembled with cutting ring and union nut on the standpipe **-SV**

<sup>1</sup> Weight including cutting ring and union nut on the standpipe.

<sup>2</sup> Standard scope of delivery: Fitting body assembled with cutting ring and union nut on the standpipe.

Please note: Standpipes are always factory-assembled with cutting rings and union nuts.

The union nut assembled on the standpipe has to be tightened by only 1/12 a turn (equivalent to 30°) beyond the fixed point.



Male stud acc. to DIN 3852-1 (Form B) / ISO 9974-3 (Type B)  
Port acc. to DIN 3852-1 (Form X) / ISO 9974-1

Torque recommendations for Steel mating material.

Male threaded studs were designed for female threaded ports in components made of steel. For applications with components made of softer mating materials (e.g. Aluminium), the use of connectors with additionally rolled male threads is recommended.  
Please contact STAUFF prior to the assembly for further information.



**Straight Male Stud Standpipe Fitting**  
**Type FI-EGE-...-R-WD • Series L / S**

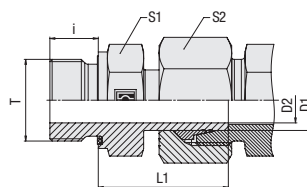

**Whitworth Parallel Pipe Thread (BSPP)**

**Profile Sealing Ring**

**Ordering Codes**

**\*FI-EGE\*-10\*L\*R\*-WD\*-B\*-W3\*-SV**

- \* Straight Male Stud Standpipe Fitting **FI-EGE**
- \* Outside Tube Diameter D1 (in mm) **-10**
- \* Series Light Series (page 158) **L**  
Heavy Series (page 159) **S**
- \* Thread Type Whitworth Parallel Pipe Thread (BSPP) **R**
- If required, please indicate special sizes, e.g. R1/8!
- \* Seal Type Profile Sealing Ring **-WD**
- \* Seal Material NBR (Buna-N®) **-B**  
FKM (Viton®) **-V**  
EPDM **-E**
- \* Material Code Steel, zinc/nickel-plated **-W3**
- Please contact STAUFF for alternative materials and surface finishings.
- \* Assembling / Kitting Fitting body assembled with cutting ring and union nut on the standpipe **-SV**

**Spare Parts / Accessories**



Profile Sealing Ring  
 Type **WDG**

Page 238

Series	Tube OD (mm/in)	PN (bar/psi)	Dimensions (mm/in)						Torque (N-m/ft-lb)	Weight (kg/lbs) ca. per 100 <sup>1</sup>	Ordering Codes <sup>2</sup>
			Thread T	D2	L1	i	S1	S2			
L	6	315	G 1/8	3,5	24,5	8	14	14	18	2,29	FI-EGE-06LR-WD-B-W3-SV
	.24	4568		.14	.96	.31	.55	.55	13.3	5.04	
	8	315	G 1/4	4,5	29,5	12	19	17	35	4,43	FI-EGE-08LR-WD-B-W3-SV
	.31	4568		.18	1.16	.47	.75	.67	25.8	9.75	
	10	315	G 1/4	7	27,5	12	19	19	35	5,04	FI-EGE-10LR-WD-B-W3-SV
	.39	4568		.28	1.08	.47	.75	.75	25.8	11.09	
	10	315	G 3/8	6	27,5	12	22	22	70	5,91	FI-EGE-10LR3/8-WD-B-W3-SV
	.39	4568		.24	1.08	.47	.87	.87	51.8	13.03	
	10	315	G 1/2	6	34,5	14	27	19	90	10,04	FI-EGE-10LR1/2-WD-B-W3-SV
	.39	4568		.24	1.36	.55	1.06	.75	66.6	22.13	
	12	315	G 1/4	7	27,5	12	19	22	35	6,07	FI-EGE-12LR1/4-WD-B-W3-SV
	.47	4568		.28	1.08	.47	.75	.87	25.8	13.38	
	12	315	G 3/8	7,5	34	12	22	22	70	9,23	FI-EGE-12LR-WD-B-W3-SV
	.47	4568		.30	1.34	.47	.87	.87	51.8	20.31	
	12	315	G 1/2	7	34,5	14	27	22	90	12,86	FI-EGE-12LR1/2-WD-B-W3-SV
	.47	4568		.28	1.36	.55	1.06	.87	66.6	28.35	
	15	315	G 3/8	10	31	12	22	27	70	9,72	FI-EGE-15LR3/8-WD-B-W3-SV
	.59	4568		.39	1.22	.47	.87	1.06	51.8	21.43	
	15	315	G 1/2	11	32	14	27	27	90	13,01	FI-EGE-15LR-WD-B-W3-SV
	.59	4568		.43	1.26	.55	1.06	1.06	66.6	28.62	
	18	315	G 1/2	14	31,5	14	27	27	90	13,89	FI-EGE-18LR-WD-B-W3-SV
	.71	4568		.55	1.24	.55	1.06	1.06	66.6	30.55	
	18	315	G 3/4	13	31,5	16	32	32	180	18,26	FI-EGE-18LR3/4-WD-B-W3-SV
	.71	4568		.51	1.24	.63	1.26	1.26	133.2	40.26	
22	160	G 3/4	18	32,5	16	32	36	180	19,63	FI-EGE-22LR-WD-B-W3-SV	
.87	2320		.71	1.28	.63	1.26	1.42	133.2	43.19		
28	160	G 1	23	35	18	41	41	310	28,64	FI-EGE-28LR-WD-B-W3-SV	
1.10	2320		.91	1.38	.71	1.61	1.61	229.4	63.02		
35	160	G 1 1/4	29,5	42,5	20	50	50	450	46,03	FI-EGE-35LR-WD-B-W3-SV	
1.38	2320		1.16	1.67	.79	1.97	1.97	333.0	101.26		
42	160	G 1 1/2	35,5	46,5	22	55	60	540	69,40	FI-EGE-42LR-WD-B-W3-SV	
1.65	2320		1.40	1.83	.87	2.17	2.36	399.6	152.68		

<sup>1</sup> Weight including cutting ring and union nut on the standpipe.

<sup>2</sup> Standard scope of delivery: Fitting body assembled with cutting ring and union nut on the standpipe.

Please note: Standpipes are always factory-assembled with cutting rings and union nuts.

The union nut assembled on the standpipe has to be tightened by only 1/12 a turn (equivalent to 30°) beyond the fixed point.



Male stud acc. to ISO 1179-2 (Type E)  
 Port acc. to ISO 1179-1

Torque recommendations for Steel mating material.

Male threaded studs were designed for female threaded ports in components made of steel. For applications with components made of softer mating materials (e.g. Aluminium), the use of connectors with additionally rolled male threads is recommended.  
 Please contact STAUFF prior to the assembly for further information.

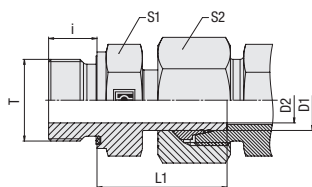

**Straight Male Stud Standpipe Fitting  
Type FI-EGE-...-R-WD • Series L / S**

**Whitworth Parallel Pipe Thread (BSPP)**
**Profile Sealing Ring**

Series	Tube OD		Dimensions (mm/in)	D2	L1	i	S1	S2	Torque (N•m/ft•lb)	Weight (kg/lbs) Ca.	Ordering Codes <sup>2</sup>
	(mm/in)	PN (bar/PSI)									
S	6	630	G 1/4	3,5	27	12	19	17	55	4,95	FI-EGE-06SR-WD-B-W3-SV
	.24	9135		.14	1.06	.47	.75	.67	40,7	10,89	
	8	630	G 1/4	4,5	29,5	12	19	19	55	5,95	FI-EGE-08SR-WD-B-W3-SV
	.31	9135		.18	1.16	.47	.75	.75	40,7	13,09	
	10	630	G 1/4	6	31,5	12	19	22	55	7,32	FI-EGE-10SR1/4-WD-B-W3-SV
	.39	9135		.24	1.24	.47	.75	.87	40,7	16,14	
	10	630	G 3/8	6,5	32	12	22	22	80	8,71	FI-EGE-10SR-WD-B-W3-SV
	.39	9135		.26	1.26	.47	.87	.87	59,2	19,15	
	12	630	G 1/4	5	34	12	19	24	55	8,98	FI-EGE-12SR1/4-WD-B-W3-SV
	.47	9135		.2	1.34	.47	.75	.94	40,7	19,80	
	12	630	G 3/8	7,5	34	12	22	24	80	10,02	FI-EGE-12SR-WD-B-W3-SV
	.47	9135		.30	1.34	.47	.87	.94	59,2	22,05	
	12	630	G 1/2	7,3	34,5	14	27	24	115	13,45	FI-EGE-12SR1/2-WD-B-W3-SV
	.47	9135		.29	1.36	.55	1.06	.94	85,1	29,65	
	14	630	G 1/2	9,5	36,5	14	27	27	115	15,40	FI-EGE-14SR-WD-B-W3-SV
	.55	9135		.37	1.44	.55	1.06	1.06	85,1	33,88	
	16	630	G 3/8	10,5	37	12	22	30	80	13,46	FI-EGE-16SR3/8-WD-B-W3-SV
	.63	9135		.41	1.46	.47	.87	1.18	59,2	36,29	
	16	400	G 1/2	11,5	37	14	27	30	115	16,88	FI-EGE-16SR-WD-B-W3-SV
	.63	5800		.45	1.46	.55	1.06	1.18	85,1	37,13	
	16	400	G 3/4	11,5	39	16	32	36	180	23,32	FI-EGE-16SR3/4-WD-B-W3-SV
	.63	5800		.45	1.54	.63	1.26	1.42	133,2	51,41	
	20	400	G 1/2	12	43	14	32	36	115	23,01	FI-EGE-20SR1/2-WD-B-W3-SV
	.79	5800		.47	1.69	.55	1.26	1.42	85,1	50,73	
	20	400	G 3/4	15,5	43	16	32	36	180	26,88	FI-EGE-20SR-WD-B-W3-SV
	.79	5800		.61	1.69	.63	1.26	1.42	133,2	59,14	
	25	400	G 1	18	48	18	41	46	310	48,81	FI-EGE-25SR-WD-B-W3-SV
	.98	5800		.71	1.89	.71	1.61	1.81	229,4	107,38	
	30	400	G 1 1/4	23,5	51	20	50	50	450	62,10	FI-EGE-30SR-WD-B-W3-SV
	1.18	5800		.93	2.01	.79	1.97	1.97	333,0	202,62	
38	315	G 1 1/2	29	60	22	55	60	540	97,70	FI-EGE-38SR-WD-B-W3-SV	
1.50	4568		1.14	2.36	.87	2.17	2.36	399,6	214,94		

**Ordering Codes**
**\*FI-EGE\*-10\*L\*R\*-WD\*-B\*-W3\*-SV**

- \* Straight Male Stud Standpipe Fitting **FI-EGE**
- \* Outside Tube Diameter D1 (in mm) **-10**
- \* Series Light Series (page 158) **L**  
Heavy Series (page 159) **S**
- \* Thread Type Whitworth Parallel Pipe Thread (BSPP) **R**

If required, please indicate special sizes, e.g. R1/8!

- \* Seal Type Profile Sealing Ring **-WD**
- \* Seal Material NBR (Buna-N®) **-B**  
FKM (Viton®) **-V**  
EPDM **-E**
- \* Material Code Steel, zinc/nickel-plated **-W3**

Please contact STAUFF for alternative materials and surface finishings.

- \* Assembling / Kitting Fitting body assembled with cutting ring and union nut on the standpipe **-SV**

**Spare Parts / Accessories**

 Profile Sealing Ring  
Type **WDG**

Page 238

<sup>1</sup> Weight including cutting ring and union nut on the standpipe.

<sup>2</sup> Standard scope of delivery: Fitting body assembled with cutting ring and union nut on the standpipe.

Please note: Standpipes are always factory-assembled with cutting rings and union nuts.

The union nut assembled on the standpipe has to be tightened by only 1/12 a turn (equivalent to 30°) beyond the fixed point.

 Male stud acc. to ISO 1179-2 (Type E)  
Port acc. to ISO 1179-1

Torque recommendations for Steel mating material.

 Male threaded studs were designed for female threaded ports in components made of steel. For applications with components made of softer mating materials (e.g. Aluminium), the use of connectors with additionally rolled male threads is recommended.  
Please contact STAUFF prior to the assembly for further information.

**Straight Male Stud Standpipe Fitting**  
**Type FI-EGE-...-M-WD • Series L / S**

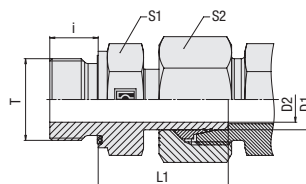

**Ordering Codes**

**\*FI-EGE\*-10\*L\*M\*-WD\*-B\*-W3\*-SV**

- \* Straight Male Stud Standpipe Fitting **FI-EGE**
- \* Outside Tube Diameter D1 (in mm) **-10**
- \* Series **L** Light Series  
**S** Heavy Series
- \* Thread Type **M** Metric Parallel Thread
- If required, please indicate special sizes, e.g. M12x1.5!
- \* Seal Type **-WD** Profile Sealing Ring
- \* Seal Material **-B** NBR (Buna-N®)  
**-V** FKM (Viton®)  
**-E** EPDM
- \* Material Code **-W3** Steel, zinc/nickel-plated
- Please contact STAUFF for alternative materials and surface finishings.
- \* Assembling / Kitting **-SV** Fitting body assembled with cutting ring and union nut on the standpipe

**Spare Parts / Accessories**



Profile Sealing Ring  
 Type **WDG**

Page 238

**Profile Sealing Ring**

**Metric Parallel Thread**

Series	Tube OD (mm/in)	PN (bar/psi)	Dimensions (mm/in)						Torque (N·m/ft·lb)	Weight (kg/lbs) ca. per 100 <sup>1</sup>	Ordering Codes <sup>2</sup>
			Thread T	D2	L1	i	S1	S2			
L	6	500	M 10 x 1	3,5	24,5	8	14	14	18	2,30	FI-EGE-06LM-WD-B-W3-SV
	.24	7251		.14	.96	.31	.55	.55	13.3	5,06	
	8	500	M 12 x 1,5	5,5	26,5	12	17	17	25	3,90	FI-EGE-08LM-WD-B-W3-SV
	.31	7251		.22	1.04	.47	.67	.67	18.5	8,58	
	10	500	M 14 x 1,5	7	27,5	12	19	19	45	4,99	FI-EGE-10LM-WD-B-W3-SV
	.39	7251		.28	1.08	.47	.75	.75	33.3	10,97	
	12	400	M 16 x 1,5	9	30,5	12	22	22	55	7,18	FI-EGE-12LM-WD-B-W3-SV
	.47	5800		.35	1.20	.47	.87	.87	40.7	15,79	
	15	400	M 18 x 1,5	11	31,5	12	24	27	90	10,25	FI-EGE-15LM-WD-B-W3-SV
	.59	5800		.43	1.24	.47	.94	1.06	66.6	22,55	
	18	400	M 22 x 1,5	14	31,5	14	27	32	125	13,62	FI-EGE-18LM-WD-B-W3-SV
	.71	5800		.55	1.24	.55	1.06	1.26	92.5	29,97	
	22	250	M 26 x 1,5	18	32,5	16	32	36	180	10,60	FI-EGE-22LM-WD-B-W3-SV
	.87	3625		.71	1.28	.63	1.26	1.42	133.2	23,32	
	28	250	M 33 x 2	23	35	18	41	41	310	30,26	FI-EGE-28LM-WD-B-W3-SV
	1.10	3625		.91	1.38	.71	1.61	1.61	229.4	66,57	
35	250	M 42 x 2	29,5	42,5	20	50	50	450	47,17	FI-EGE-35LM-WD-B-W3-SV	
1.38	3625		1.16	1.67	.79	1.97	1.97	333.0	103,77		
42	250	M 48 x 2	35,5	46,5	22	55	60	540	77,85	FI-EGE-42LM-WD-B-W3-SV	
1.65	3625		1.40	1.83	.87	2.17	2.36	399.6	171,26		
S	6	800	M 12 x 1,5	3,5	27	12	17	17	35	4,34	FI-EGE-06SM-WD-B-W3-SV
	.24	11603		.14	1.06	.47	.67	.67	25.9	9,54	
	8	800	M 14 x 1,5	4,5	29,5	12	19	19	55	5,90	FI-EGE-08SM-WD-B-W3-SV
	.31	11603		.18	1.16	.47	.75	.75	40.7	12,98	
	10	800	M 16 x 1,5	6,5	32	12	22	22	70	8,20	FI-EGE-10SM-WD-B-W3-SV
	.39	11603		.26	1.26	.47	.87	.87	51.8	18,04	
	12	630	M 18 x 1,5	7,5	34	12	24	24	90	10,97	FI-EGE-12SM-WD-B-W3-SV
	.47	9135		.30	1.34	.47	.94	.94	66.6	24,14	
	14	630	M 20 x 1,5	9,5	36,5	14	27	27	125	15,57	FI-EGE-14SM-WD-B-W3-SV
	.55	9135		.37	1.44	.55	1.06	1.06	92.5	34,25	
	16	630	M 22 x 1,5	11,5	37	14	27	30	135	16,20	FI-EGE-16SM-WD-B-W3-SV
	.63	9135		.45	1.46	.55	1.06	1.18	99.9	35,64	
	20	400	M 27 x 2	15,5	43	16	32	36	180	27,06	FI-EGE-20SM-WD-B-W3-SV
	.79	5800		.61	1.69	.63	1.26	1.42	133.2	59,54	
	25	400	M 33 x 2	18	48	18	41	46	310	48,60	FI-EGE-25SM-WD-B-W3-SV
	.98	5800		.71	1.89	.71	1.61	1.81	229.4	106,92	
30	400	M 42 x 2	23,5	51	20	50	50	450	69,15	FI-EGE-30SM-WD-B-W3-SV	
1.18	5800		.93	2.01	.79	1.97	1.97	333.0	152,13		
38	420	M 48 x 2	29	60	22	55	60	540	110,29	FI-EGE-38SM-WD-B-W3-SV	
1.50	6091		1.14	2.36	.87	2.17	2.36	399.6	242,65		

<sup>1</sup> Weight including cutting ring and union nut on the standpipe.

<sup>2</sup> Standard scope of delivery: Fitting body assembled with cutting ring and union nut on the standpipe.

Please note: Standpipes are always factory-assembled with cutting rings and union nuts.

The union nut assembled on the standpipe has to be tightened by only 1/12 a turn (equivalent to 30°) beyond the fixed point.



Male stud acc. to ISO 9974-2 (Type E)  
 Port acc. to ISO 9974-1

Torque recommendations for Steel mating material.

Male threaded studs were designed for female threaded ports in components made of steel. For applications with components made of softer mating materials (e.g. Aluminium), the use of connectors with additionally rolled male threads is recommended. Please contact STAUFF prior to the assembly for further information.





**Straight Male Stud Standpipe Fitting  
Type FI-EGE-...-N • Series L / S**

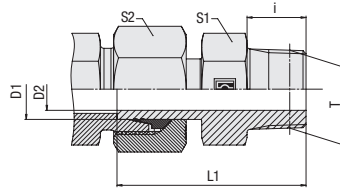

**NPT Thread**

Series	Tube OD		Dimensions (mm/in)	Weight (kg/lbs) Ca. per 100 <sup>1</sup>	Ordering Codes <sup>2</sup>					
	(mm/in)	PN (bar/PSI)								
L	D1		Thread T	D2	L1	i	S1	S2		
	L	6	315	1/8 NPT	3,3	33	10	11	14	2,27
.24		4567,5		.13	1.30	.39	.43	.55	4.99	
8		315	1/4 NPT	4	40	15,5	14	17	3,93	FI-EGE-08L1/4N-W3-SV
.31		4567,5		.16	1.57	.61	.55	.67	8.64	
10		315	1/4 NPT	6,5	41	15,5	14	19	4,46	FI-EGE-10L1/4N-W3-SV
.39		4567,5		.26	1.61	.61	.55	.75	9.81	
12		315	3/8 NPT	7	42	15,5	19	22	6,80	FI-EGE-12L3/8N-W3-SV
.47		4567,5		.28	1.65	.61	.75	.87	14.97	
15		315	1/2 NPT	10	46,5	20	22	27	10,48	FI-EGE-15L1/2N-W3-SV
.59		4567,5		.39	1.83	.79	.87	1.06	23.05	
18		315	1/2 NPT	13	49,5	20	22	32	13,44	FI-EGE-18L1/2N-W3-SV
.71		4567,5		.51	1.95	.79	.87	1.26	29.56	
22		160	3/4 NPT	16,5	49	20	27	36	18,41	FI-EGE-22L3/4N-W3-SV
.87		2320		.65	1.93	.79	1.06	1.42	40.51	
28		160	1 NPT	22	55,5	25	36	41	25,80	FI-EGE-28L1N-W3-SV
1.10		2320		.87	2.19	.98	1.42	1.61	56.76	
35		160	1 1/4 NPT	28	74,1	25,6	46	50	42,40	FI-EGE-35L1-1/4N-W3-SV
1.38		2320		1.10	2.92	1.01	1.81	1.97	93.28	
42	160	1 1/2 NPT	34	78,5	26	50	60	62,33	FI-EGE-42L1-1/2N-W3-SV	
1.65	2320		1.34	3.09	1.02	1.97	2.36	137.13		
S	6	630	1/4 NPT	3	45,1	14	14	17	1,92	FI-EGE-06S1/4N-W3-SV
	.24	9135		.12	1.78	.55	.55	.67	4.23	
	8	630	1/4 NPT	4,3	40	15,5	14	19	4,45	FI-EGE-08S1/4N-W3-SV
	.31	9135		.17	1.57	.61	.55	.75	9.78	
	10	630	3/8 NPT	6	44,5	15,5	19	22	7,29	FI-EGE-10S3/8N-W3-SV
	.39	9135		.24	1.75	.61	.75	.87	16.04	
	12	630	3/8 NPT	7,3	46,5	15,5	19	24	8,49	FI-EGE-12S3/8N-W3-SV
	.47	9135		.29	1.83	.61	.75	.94	18.67	
	14	630	1/2 NPT	10,5	53,5	20	22	27	12,81	FI-EGE-14S1/2N-W3-SV
	.55	9135		.41	2.11	.79	.87	1.06	28.19	
	16	630	1/2 NPT	13,5	58	20	22	30	16,52	FI-EGE-16S1/2N-W3-SV
	.63	9135		.53	2.28	.79	.87	1.18	36.34	
	20	400	3/4 NPT	17,5	68	20	27	36	24,50	FI-EGE-20S3/4N-W3-SV
	.79	5800		.69	2.68	.79	1.06	1.42	53.90	
	25	400	1 NPT	17,5	68	25	36	46	41,13	FI-EGE-25S1N-W3-SV
	.98	5800		.69	2.68	.98	1.42	1.81	90.49	
	30	400	1 1/4 NPT	22	70,5	26	46	50	52,80	FI-EGE-30S1-1/4N-W3-SV
	1.18	5800		.87	2.78	1.02	1.81	1.97	116.16	
38	400	1 1/2 NPT	29	92	26	50	60	83,60	FI-EGE-38S1-1/2N-W3-SV	
1.50	5800		1.14	3.62	1.02	1.97	2.36	183.92		

**Ordering Codes**

**\*FI-EGE\*-10\*L\*1/4\*N\*-W3\*-SV**

- \* Straight Male Stud Standpipe Fitting FI-EGE
- \* Outside Tube Diameter D1 (in mm) -10
- \* Series L  
S
  - Light Series
  - Heavy Series
- \* Thread Size 1/4
  - acc. to dimension table
- Please always indicate thread sizes, e.g. 1/4!
- \* Thread Type N
  - NPT Thread
- \* Material Code -W3
  - Steel, zinc/nickel-plated
- Please contact STAUFF for alternative materials and surface finishings.
- \* Assembling / Kitting -SV
  - Fitting body assembled with cutting ring and union nut on the standpipe

<sup>1</sup> Weight including cutting ring and union nut on the standpipe.

<sup>2</sup> Standard scope of delivery: Fitting body assembled with cutting ring and union nut on the standpipe.

Please note: Standpipes are always factory-assembled with cutting rings and union nuts.

The union nut assembled on the standpipe has to be tightened by only 1/12 a turn (equivalent to 30°) beyond the fixed point.

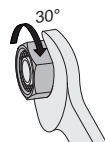

Male stud acc. to ANSI/ASME B1.20.1-1983  
Port acc. to ANSI/ASME B1.20.1-1983

Suitable liquid / plastic sealant required.

Male threaded studs were designed for female threaded ports in components made of steel. For applications with components made of softer mating materials (e.g. Aluminium), the use of connectors with additionally rolled male threads is recommended.  
Please contact STAUFF prior to the assembly for further information.



## Straight Standpipe Reducer Type FI-REDS • Series L

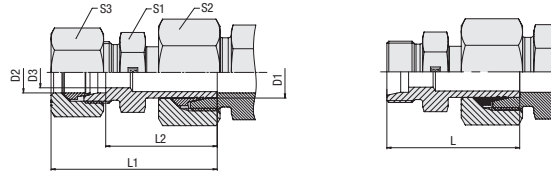

### Ordering Codes

**\*FI-REDS\*-10/\*08\*L\*-W3\*-MS+SV**

- \* Straight Standpipe Reducer **FI-REDS**
- \* Outside Tube Diameter D1 (in mm) **-10**
- \* Outside Tube Diameter D2 (in mm) **08**
- \* Series **L**  
Light Series (pages 162/163)  
Heavy Series (pages 164/165) **S**
- \* Material Code **-W3**  
Steel, zinc/nickel-plated
- Please contact STAUFF for alternative materials and surface finishings.
- \* Assembling / Kitting **-SV**  
Fitting body assembled with cutting ring and union nut on the standpipe
- MS+SV**  
Fitting body assembled with cutting rings and union nuts on all ends

### Connecting Parts

-  Cutting Ring  
Type **FI-DS** Page 28
-  Soft-Sealing Cutting Ring  
Type **FI-WDDS** Page 29
-  Support Sleeve  
Type **FI-VH** Page 31
-  STAUFF Form EVO Sealing Ring  
Type **FI-FD** Page 32
-  Union Nut  
Type **FI-M** Page 33
-  37° Flared Tube Fitting Set  
Type **FI-AB** Page 37

Series	Tube OD (mm/in)		PN (bar/psi)	Dimensions (mm/in)							Weight (%)/lbs ca. per 100	Ordering Codes <sup>3</sup>
	D1	D2		D3	L	L1 <sup>1</sup>	L2	S1	S2	S3		
L / LL	6	4	100	3	32,5	38,5	28,5	10	10	10	1,96	FI-REDS-06L/04LL-W3-SV
	.24	.16	1450	.12	1.28	1.52	1.12	.39	.39	.39	4.32	
L	8	6	500	4	33	40,5	27,5	12	17	14	3,15	FI-REDS-08/06L-W3-SV
	.31	.24	7250	.16	1.30	1.59	1.08	.47	.67	.55	6.93	
	10	6	500	4	34	41,5	28,5	12	19	14	4,00	FI-REDS-10/06L-W3-SV
	.39	.24	7250	.16	1.34	1.63	1.12	.47	.75	.55	8.79	
	10	8	500	6	35	42,5	28,5	14	19	17	3,97	FI-REDS-10/08L-W3-SV
	.39	.31	7250	.24	1.38	1.67	1.12	.55	.75	.67	8.74	
	12	6	400	4	37	44,5	28	14	22	14	4,75	FI-REDS-12/06L-W3-SV
	.47	.24	5800	.16	1.46	1.75	1.10	.55	.87	.55	10.44	
	12	8	400	6	36	44,5	29	14	22	17	5,35	FI-REDS-12/08L-W3-SV
	.47	.31	5800	.24	1.42	1.75	1.14	.55	.87	.67	11.78	
	12	10	400	8	37	45,5	30	17	22	19	5,48	FI-REDS-12/10L-W3-SV
	.47	.39	5800	.31	1.46	1.79	1.18	.67	.87	.75	12.05	
	15	6	400	4	38	46	28	17	27	14	7,53	FI-REDS-15/06L-W3-SV
	.59	.24	5800	.16	1.50	1.81	1.10	.67	1.06	.55	16.57	
	15	8	400	6	38	46	29	17	27	17	7,73	FI-REDS-15/08L-W3-SV
	.59	.31	5800	.24	1.50	1.81	1.14	.67	1.06	.67	17.01	
	15	10	400	8	37	47	30	17	27	19	8,24	FI-REDS-15/10L-W3-SV
	.59	.39	5800	.31	1.46	1.85	1.18	.67	1.06	.75	18.12	
	15	12	400	10	38	48	31	19	27	22	8,27	FI-REDS-15/12L-W3-SV
	.59	.47	5800	.39	1.50	1.89	1.22	.75	1.06	.87	18.19	
	18	6	400	4	37,5	45,5	30	19	32	14	10,36	FI-REDS-18/06L-W3-SV
	.71	.24	5800	.16	1.48	1.79	1.18	.75	1.26	.55	22.80	
	18	8	400	6	37,5	45,5	31	19	32	17	10,84	FI-REDS-18/08L-W3-SV
	.71	.31	5800	.24	1.48	1.79	1.22	.75	1.26	.67	23.85	
	18	10	400	8	39	46,5	32	19	32	19	10,98	FI-REDS-18/10L-W3-SV
	.71	.39	5800	.31	1.54	1.83	1.26	.75	1.26	.75	24.16	
	18	12	400	10	40,5	46,5	33,5	19	32	22	12,01	FI-REDS-18/12L-W3-SV
	.71	.47	5800	.39	1.59	1.83	1.32	.75	1.26	.87	26.43	
	18	15	400	12	41	47,5	34	24	32	27	12,76	FI-REDS-18/15L-W3-SV
	.71	.59	5800	.47	1.61	1.87	1.34	.94	1.26	1.06	28.07	
	22	6	250	4	39,5	47	32	24	36	14	13,75	FI-REDS-22/06L-W3-SV
	.87	.24	3625	.16	1.56	1.85	1.26	.94	1.42	.55	30.25	
	22	8	250	6	43	46,5	34	24	36	17	19,87	FI-REDS-22/08L-W3-SV
	.87	.31	3625	.24	1.69	1.83	1.34	.94	1.42	.67	43.72	
	22	10	250	8	41	47,5	34	24	36	19	15,17	FI-REDS-22/10L-W3-SV
	.87	.39	3625	.31	1.61	1.87	1.34	.94	1.42	.75	33.37	
	22	12	250	10	39,5	47,5	34,5	24	36	22	15,45	FI-REDS-22/12L-W3-SV
	.87	.47	3625	.39	1.56	1.87	1.36	.94	1.42	.87	34.00	
	22	15	250	12	40,5	48,5	36	24	36	27	16,02	FI-REDS-22/15L-W3-SV
	.87	.59	3625	.47	1.59	1.91	1.42	.94	1.42	1.06	35.24	
	22	18	250	15	44	50,5	36,5	27	36	32	17,93	FI-REDS-22/18L-W3-SV
	.87	.71	3625	.59	1.73	1.99	1.44	1.06	1.42	1.26	39.45	

<sup>1</sup> Approximate dimension in assembled condition.

<sup>2</sup> Weight including cutting ring and union nut on the standpipe.

<sup>3</sup> Standard scope of delivery: Fitting body assembled with cutting ring and union nut on the standpipe.

Please note: Standpipes are always factory-assembled with cutting rings and union nuts.

The union nut assembled on the standpipe has to be tightened by only 1/12 a turn (equivalent to 30°) beyond the fixed point.



Straight Standpipe Reducer  
Type FI-REDS ■ Series L

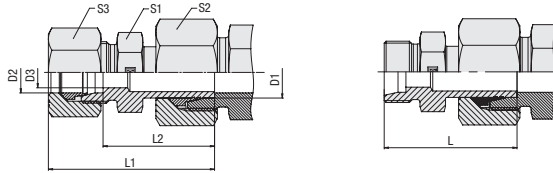

Series	Tube OD (mm/in)		PN (bar/psi)	Dimensions (mm/in)						Weight ( <sup>kg</sup> /lbs) ca. per 100	Ordering Codes <sup>3</sup>	
	D1	D2		D3	L	L1 <sup>1</sup>	L2	S1	S2			S3
L	28	6	250	4	41	49	34,5	30	41	14	18,12	FI-REDS-28/06L-W3-SV
	1.10	.24	3625	.16	1.61	1.93	1.36	1.18	1.61	.55	39.85	
L	28	8	250	6	42	50	34,5	30	41	17	18,24	FI-REDS-28/08L-W3-SV
	1.10	.31	3625	.24	1.65	1.97	1.36	1.18	1.61	.67	40.12	
L	28	10	250	8	41	49	35,5	30	41	19	18,45	FI-REDS-28/10L-W3-SV
	1.10	.39	3625	.31	1.61	1.93	1.40	1.18	1.61	.75	40.58	
L	28	12	250	10	41	49	35,5	30	41	22	19,79	FI-REDS-28/12L-W3-SV
	1.10	.47	3625	.39	1.61	1.93	1.40	1.18	1.61	.87	43.54	
L	28	15	250	12	42	50	36,5	30	41	27	20,30	FI-REDS-28/15L-W3-SV
	1.10	.59	3625	.47	1.65	1.97	1.44	1.18	1.61	1.06	44.66	
L	28	18	250	15	43,5	52	36	30	41	32	20,48	FI-REDS-28/18L-W3-SV
	1.10	.71	3625	.59	1.71	2.05	1.42	1.18	1.61	1.26	45.05	
L	28	22	250	19	45,5	54	38	32	41	36	23,25	FI-REDS-28/22L-W3-SV
	1.10	.87	3625	.75	1.79	2.13	1.50	1.26	1.61	1.42	51.14	
L	35	6	250	4	48	56	40,5	36	50	14	29,53	FI-REDS-35/06L-W3-SV
	1.38	.24	3625	.16	1.89	2.20	1.59	1.42	1.97	.55	64.97	
L	35	8	250	6	48	56	40,5	36	50	17	28,78	FI-REDS-35/08L-W3-SV
	1.38	.31	3625	.24	1.89	2.20	1.59	1.42	1.97	.67	63.32	
L	35	10	250	8	49	57	41,5	36	50	19	31,70	FI-REDS-35/10L-W3-SV
	1.38	.39	3625	.31	1.93	2.24	1.63	1.42	1.97	.75	69.74	
L	35	12	250	10	47	55	41,5	36	50	22	32,26	FI-REDS-35/12L-W3-SV
	1.38	.47	3625	.39	1.85	2.17	1.63	1.42	1.97	.87	70.97	
L	35	15	250	12	48,5	56,5	42,5	36	50	27	28,97	FI-REDS-35/15L-W3-SV
	1.38	.59	3625	.47	1.91	2.22	1.67	1.42	1.97	1.06	63.73	
L	35	18	250	15	49,5	58,5	42	36	50	32	32,20	FI-REDS-35/18L-W3-SV
	1.38	.71	3625	.59	1.95	2.30	1.65	1.42	1.97	1.26	70.83	
L	35	22	250	19	51,5	60,5	44	36	50	36	32,94	FI-REDS-35/22L-W3-SV
	1.38	.87	3625	.75	2.03	2.38	1.73	1.42	1.97	1.42	72.47	
L	35	28	250	24	52,5	61,5	44	41	50	41	34,18	FI-REDS-35/28L-W3-SV
	1.38	1.10	3625	.94	2.07	2.42	1.73	1.61	1.97	1.61	75.19	
L	42	10	250	8	51	59	45	46	60	19	45,84	FI-REDS-42/10L-W3-SV
	1.65	.39	3625	.31	2.01	2.32	1.77	1.81	2.36	.75	100.85	
L	42	12	250	10	52	60	45	46	60	22	56,37	FI-REDS-42/12L-W3-SV
	1.65	.47	3625	.39	2.05	2.36	1.77	1.81	2.36	.87	124.01	
L	42	15	250	12	52	60	46	46	60	27	58,28	FI-REDS-42/15L-W3-SV
	1.65	.59	3625	.47	2.05	2.36	1.81	1.81	2.36	1.06	115.06	
L	42	18	250	15	53	61	45,5	46	60	32	51,80	FI-REDS-42/18L-W3-SV
	1.65	.71	3625	.59	2.09	2.40	1.79	1.81	2.36	1.26	113.96	
L	42	22	250	19	54	63	47,5	46	60	36	58,28	FI-REDS-42/22L-W3-SV
	1.65	.87	3625	.75	2.13	2.48	1.87	1.81	2.36	1.42	128.22	
L	42	28	250	24	55	64	47,5	46	60	41	52,40	FI-REDS-42/28L-W3-SV
	1.65	1.10	3625	.94	2.17	2.52	1.87	1.81	2.36	1.61	115.28	
L	42	35	250	30	57	69	46,5	46	60	50	53,30	FI-REDS-42/35L-W3-SV
	1.65	1.38	3625	1.18	2.24	2.72	1.83	1.81	2.36	1.97	117.26	

Ordering Codes

\*FI-REDS\*-10/\*08\*L\*-W3\*-MS+SV

- \* Straight Standpipe Reducer **FI-REDS**
- \* Outside Tube Diameter D1 (in mm) **-10**
- \* Outside Tube Diameter D2 (in mm) **08**
- \* Series Light Series (pages 162/163) **L**  
Heavy Series (pages 164/165) **S**
- \* Material Code Steel, zinc/nickel-plated **-W3**

Please contact STAUFF for alternative materials and surface finishings.

- \* Assembling / Kitting Fitting body assembled with cutting ring and union nut on the standpipe **-SV**
- Fitting body assembled with cutting rings and union nuts on all ends **-MS+SV**

Connecting Parts

- Cutting Ring Type **FI-DS** Page 28
- Soft-Sealing Cutting Ring Type **FI-WDDS** Page 29
- Support Sleeve Type **FI-VH** Page 31
- STAUFF Form EVO Sealing Ring Type **FI-FD** Page 32
- Union Nut Type **FI-M** Page 33
- 37° Flared Tube Fitting Set Type **FI-AB** Page 37

<sup>1</sup> Approximate dimension in assembled condition.  
<sup>2</sup> Weight including cutting ring and union nut on the standpipe.  
<sup>3</sup> Standard scope of delivery: Fitting body assembled with cutting ring and union nut on the standpipe.

Please note: Standpipes are always factory-assembled with cutting rings and union nuts.

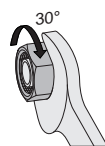

The union nut assembled on the standpipe has to be tightened by only 1/12 a turn (equivalent to 30°) beyond the fixed point.



## Straight Standpipe Reducer Type FI-REDS • Series S

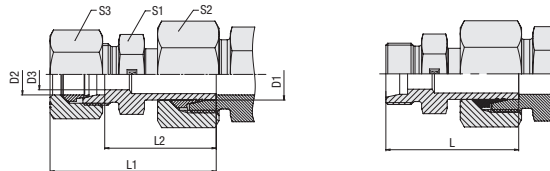

### Ordering Codes

**\*FI-REDS\*-10/\*08\*S\*-W3\*-MS+SV**

- \* Straight Standpipe Reducer **FI-REDS**
- \* Outside Tube Diameter D1 (in mm) **-10**
- \* Outside Tube Diameter D2 (in mm) **08**
- \* Series **L**  
Light Series (pages 162/163)  
**S** Heavy Series (pages 164/165)
- \* Material Code **-W3**  
Steel, zinc/nickel-plated
- Please contact STAUFF for alternative materials and surface finishings.
- \* Assembling / Kitting **-SV**  
Fitting body assembled with cutting ring and union nut on the standpipe
- MS+SV**  
Fitting body assembled with cutting rings and union nuts on all ends

### Connecting Parts

-  Cutting Ring  
Type **FI-DS** Page 28
-  Soft-Sealing Cutting Ring  
Type **FI-WDDS** Page 29
-  Support Sleeve  
Type **FI-VH** Page 31
-  STAUFF Form EVO Sealing Ring  
Type **FI-FD** Page 32
-  Union Nut  
Type **FI-M** Page 33
-  37° Flared Tube Fitting Set  
Type **FI-AB** Page 37

Series	Tube OD (mm/in)		PN (bar/psi)	Dimensions (mm/in)							Weight (%/lbs) ca. per 100	Ordering Codes <sup>3</sup>
	D1	D2		D3	L	L1 <sup>1</sup>	L2	S1	S2	S3		
S	8	6	800	4	37	45	30	14	19	17	4,42	FI-REDS-08/06S-W3-SV
	.31	.24	11600	.16	1.46	1.77	1.18	.55	.75	.67	9.73	
	10	6	800	4	39	47	34	14	22	17	6,26	FI-REDS-10/06S-W3-SV
	.39	.24	11600	.16	1.54	1.85	1.34	.55	.87	.67	13.78	
	10	8	800	5	41	49	34	17	22	19	6,81	FI-REDS-10/08S-W3-SV
	.39	.31	11600	.20	1.61	1.93	1.34	.67	.87	.75	14.98	
	12	6	630	4	39	47	36	14	24	17	6,70	FI-REDS-12/06S-W3-SV
	.47	.24	9135	.16	1.54	1.85	1.42	.55	.94	.67	14.74	
	12	8	630	5	41	49	31,5	17	24	19	7,46	FI-REDS-12/08S-W3-SV
	.47	.31	9135	.20	1.61	1.93	1.24	.67	.94	.75	16.41	
	12	10	630	7	41	50	36	19	24	22	7,80	FI-REDS-12/10S-W3-SV
	.47	.39	9135	.28	1.61	1.97	1.42	.75	.94	.87	17.16	
	14	6	630	4	42	50	37	17	27	17	9,61	FI-REDS-14/06S-W3-SV
	.55	.24	9135	.16	1.65	1.97	1.46	.67	1.06	.67	21.15	
	14	8	630	5	44	52	37	17	27	19	10,19	FI-REDS-14/08S-W3-SV
	.55	.31	9135	.20	1.73	2.05	1.46	.67	1.06	.75	22.42	
	14	10	630	7	44	53	36,5	19	27	22	11,24	FI-REDS-14/10S-W3-SV
	.55	.39	9135	.28	1.73	2.09	1.44	.75	1.06	.87	24.72	
	14	12	630	8	44	55	36,5	22	27	24	11,98	FI-REDS-14/12S-W3-SV
	.55	.47	9135	.31	1.73	2.17	1.44	.87	1.06	.94	26.36	
	16	6	630	4	45,5	50	38,5	17	30	17	12,14	FI-REDS-16/06S-W3-SV
	.63	.24	9135	.16	1.79	1.97	1.52	.67	1.18	.67	26.71	
	16	8	630	5	44	52	38,5	17	30	19	12,29	FI-REDS-16/08S-W3-SV
	.63	.31	9135	.20	1.73	2.05	1.52	.67	1.18	.75	27.03	
16	10	630	7	44	53	38	19	30	22	12,78	FI-REDS-16/10S-W3-SV	
.63	.39	9135	.28	1.73	2.09	1.50	.75	1.18	.87	28.12		
16	12	630	8	46	55	38	22	30	24	14,39	FI-REDS-16/12S-W3-SV	
.63	.47	9135	.31	1.81	2.17	1.50	.87	1.18	.94	31.66		
16	14	630	10	47,5	58	39,5	24	30	27	14,70	FI-REDS-16/14S-W3-SV	
.63	.55	9135	.39	1.87	2.28	1.56	.94	1.18	1.06	32.34		
20	6	400	4	47	55	46,5	22	36	17	20,15	FI-REDS-20/06S-W3-SV	
.79	.24	5800	.16	1.85	2.17	1.83	.87	1.42	.67	44.33		
20	8	400	5	48	56	46,5	22	36	19	17,67	FI-REDS-20/08S-W3-SV	
.79	.31	5800	.20	1.89	2.20	1.83	.87	1.42	.75	38.88		
20	10	400	7	53,5	57	46	22	36	22	16,90	FI-REDS-20/10S-W3-SV	
.79	.39	5800	.28	2.11	2.24	1.81	.87	1.42	.87	37.18		
20	12	400	8	50	59	46	22	36	24	18,10	FI-REDS-20/12S-W3-SV	
.79	.47	5800	.31	1.97	2.32	1.81	.87	1.42	.94	39.82		
20	14	400	10	52	62	47,5	24	36	27	19,20	FI-REDS-20/14S-W3-SV	
.79	.55	5800	.39	2.05	2.44	1.87	.94	1.42	1.06	42.24		
20	16	400	12	55,5	62	47	27	36	30	23,31	FI-REDS-20/16S-W3-SV	
.79	.63	5800	.47	2.19	2.44	1.85	1.06	1.42	1.18	51.27		

<sup>1</sup> Approximate dimension in assembled condition.

<sup>2</sup> Weight including cutting ring and union nut on the standpipe.

<sup>3</sup> Standard scope of delivery: Fitting body assembled with cutting ring and union nut on the standpipe.

Please note: Standpipes are always factory-assembled with cutting rings and union nuts.

The union nut assembled on the standpipe has to be tightened by only 1/12 a turn (equivalent to 30°) beyond the fixed point.

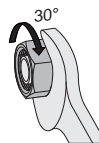

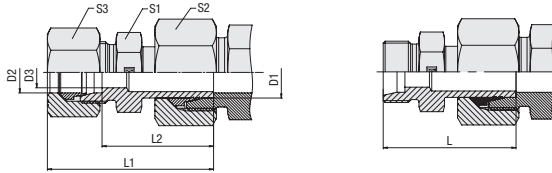
**Straight Standpipe Reducer  
Type FI-REDS ■ Series S**

Series	Tube OD (mm/in)		PN (bar/psi)	Dimensions (mm/in)							Weight (kg/lbs) ca. per 100	Ordering Codes <sup>3</sup>
	D1	D2		D3	L	L1 <sup>1</sup>	L2	S1	S2	S3		
S	25	6	400	4	50	58	51	27	46	17	31,38	FI-REDS-25/06S-W3-SV
	.98	.24	5800	.16	1.97	2.28	2.01	1.06	1.81	.67	69.04	
25	8	400	5	51	59	51	27	46	19	31,65	FI-REDS-25/08S-W3-SV	
	.98	.31	5800	.20	2.01	2.32	2.01	1.06	1.81	.75		69.62
25	10	400	7	58	60	50,5	27	46	22	35,51	FI-REDS-25/10S-W3-SV	
	.98	.39	5800	.28	2.28	2.36	1.99	1.06	1.81	.87		78.12
25	12	400	8	53	62	50,5	27	46	24	38,88	FI-REDS-25/12S-W3-SV	
	.98	.47	5800	.31	2.09	2.44	1.99	1.06	1.81	.94		85.54
25	14	400	10	60	65	52	27	46	27	41,86	FI-REDS-25/14S-W3-SV	
	.98	.55	5800	.39	2.36	2.56	2.05	1.06	1.81	1.06		92.10
25	16	400	12	60	65	51,5	27	46	30	35,70	FI-REDS-25/16S-W3-SV	
	.98	.63	5800	.47	2.36	2.56	2.03	1.06	1.81	1.18		78.54
25	20	400	16	62	70	51,5	32	46	36	39,99	FI-REDS-25/20S-W3-SV	
	.98	.79	5800	.63	2.44	2.76	2.03	1.26	1.81	1.42		87.97
30	6	400	4	53	61	52,5	32	50	17	42,88	FI-REDS-30/06S-W3-SV	
	1.18	.24	5800	.16	2.09	2.40	2.07	1.26	1.97	.67		94.33
30	8	400	5	53	61	52,5	32	50	19	38,19	FI-REDS-30/08S-W3-SV	
	1.18	.31	5800	.20	2.09	2.40	2.07	1.26	1.97	.75		84.01
30	10	400	7	53	62	52	32	50	22	43,13	FI-REDS-30/10S-W3-SV	
	1.18	.39	5800	.28	2.09	2.44	2.05	1.26	1.97	.87		94.88
30	12	400	8	59,5	65	52	32	50	24	38,53	FI-REDS-30/12S-W3-SV	
	1.18	.47	5800	.31	2.34	2.56	2.05	1.26	1.97	.94		84.76
30	14	400	10	61,5	68	53,5	32	50	27	39,19	FI-REDS-30/14S-W3-SV	
	1.18	.55	5800	.39	2.42	2.68	2.11	1.26	1.97	1.06		86.23
30	16	400	12	61,5	68	53	32	50	30	43,00	FI-REDS-30/16S-W3-SV	
	1.18	.63	5800	.47	2.42	2.68	2.09	1.26	1.97	1.18		94.59
30	20	400	16	62	73	53	32	50	36	55,33	FI-REDS-30/20S-W3-SV	
	1.18	.79	5800	.63	2.44	2.87	2.09	1.26	1.97	1.42		121.72
30	25	400	20	66	78	53,5	41	50	46	52,60	FI-REDS-30/25S-W3-SV	
	1.18	.98	5800	.79	2.60	3.07	2.11	1.61	1.97	1.81		115.72
38	6	315	4	60	68	56	41	60	17	64,17	FI-REDS-38/06S-W3-SV	
	1.50	.24	4568	.16	2.36	2.68	2.20	1.61	2.36	.67		141.16
38	8	315	5	60	68	56	41	60	19	64,88	FI-REDS-38/08S-W3-SV	
	1.50	.31	4568	.20	2.36	2.68	2.20	1.61	2.36	.75		142.73
38	10	315	7	62	71	55,5	41	60	22	63,89	FI-REDS-38/10S-W3-SV	
	1.50	.39	4568	.28	2.44	2.80	2.19	1.61	2.36	.87		140.55
38	12	315	8	62	69	55,5	41	60	24	64,80	FI-REDS-38/12S-W3-SV	
	1.50	.47	4568	.31	2.44	2.72	2.19	1.61	2.36	.94		142.56
38	14	315	10	65	75	57	41	60	27	67,79	FI-REDS-38/14S-W3-SV	
	1.50	.55	4568	.39	2.56	2.95	2.24	1.61	2.36	1.06		149.14
38	16	315	12	65	74	56,5	41	60	30	64,60	FI-REDS-38/16S-W3-SV	
	1.50	.63	4568	.47	2.56	2.91	2.22	1.61	2.36	1.18		142.12
38	20	315	16	68	79	56,5	41	60	36	72,99	FI-REDS-38/20S-W3-SV	
	1.50	.79	4568	.63	2.68	3.11	2.22	1.61	2.36	1.42		160.57
38	25	315	20	69	84	57	41	60	46	66,80	FI-REDS-38/25S-W3-SV	
	1.50	.98	4568	.79	2.72	3.31	2.24	1.61	2.36	1.81		146.96
38	30	315	25	74	87	57,5	46	60	50	71,80	FI-REDS-38/30S-W3-SV	
	1.50	1.18	4568	.98	2.91	3.43	2.26	1.81	2.36	1.97		157.96

**Ordering Codes**
**\*FI-REDS\*-10/\*08\*S\*-W3\*-MS+SV**

- \* Straight Standpipe Reducer **FI-REDS**
  - \* Outside Tube Diameter D1 (in mm) **-10**
  - \* Outside Tube Diameter D2 (in mm) **08**
  - \* Series Light Series (pages 162/163) **L**  
Heavy Series (pages 164/165) **S**
  - \* Material Code Steel, zinc/nickel-plated **-W3**
- Please contact STAUFF for alternative materials and surface finishings.
- \* Assembling / Kitting Fitting body assembled with cutting ring and union nut on the standpipe **-SV**
  - Fitting body assembled with cutting rings and union nuts on all ends **-MS+SV**

**Connecting Parts**

-  Cutting Ring Type **FI-DS** Page 28
-  Soft-Sealing Cutting Ring Type **FI-WDDS** Page 29
-  Support Sleeve Type **FI-VH** Page 31
-  STAUFF Form EVO Sealing Ring Type **FI-FD** Page 32
-  Union Nut Type **FI-M** Page 33
-  37° Flared Tube Fitting Set Type **FI-AB** Page 37

<sup>1</sup> Approximate dimension in assembled condition.

<sup>2</sup> Weight including cutting ring and union nut on the standpipe.

<sup>3</sup> Standard scope of delivery: Fitting body assembled with cutting ring and union nut on the standpipe.

Please note: Standpipes are always factory-assembled with cutting rings and union nuts.

The union nut assembled on the standpipe has to be tightened by only 1/12 a turn (equivalent to 30°) beyond the fixed point.

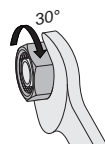

**Adjustable Standpipe Elbow**  
Type FI-EW ▪ Series L / S

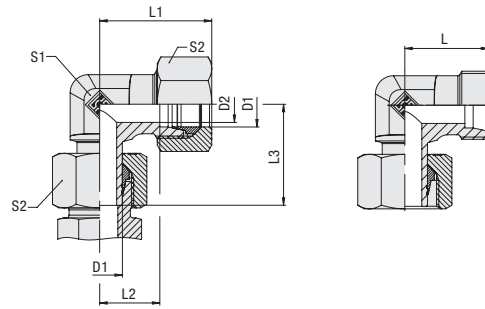

**Ordering Codes**

**\*FI-EW\*-10\*L\*-W3\*-MS+SV**

- \* Adjustable Standpipe Elbow **FI-EW**
- \* Outside Tube Diameter D1 (in mm) **-10**
- \* Series **L**  
Light Series  
**S**  
Heavy Series
- \* Material Code **-W3**  
Steel, zinc/nickel-plated
- \* Assembling / Kitting **-SV**  
Fitting body assembled with cutting ring and union nut on the standpipe
- MS+SV**  
Fitting body assembled with cutting rings and union nuts on all ends

**Connecting Parts**

- Cutting Ring  
Type **FI-DS** Page 28
- Soft-Sealing Cutting Ring  
Type **FI-WDDS** Page 29
- Support Sleeve  
Type **FI-VH** Page 31
- STAUFF Form EVO Sealing Ring  
Type **FI-FD** Page 32
- Union Nut  
Type **FI-M** Page 33
- 37° Flared Tube Fitting Set  
Type **FI-AB** Page 37

Series	Tube OD	PN	Dimensions							Weight (kg/lbs) ca. per 100	Ordering Codes <sup>3</sup>
	(mm/in) D1		(bar/psi)	(mm/in) D2	L	L1 <sup>1</sup>	L2	L3	S1		
L	6	500	4	19	27	12	26	12	14	2,89	FI-EW-06L-W3-SV
	.24	7251	.16	.75	1.06	.47	1.02	.47	.55	6,39	
	8	500	6	21	29	14	27,5	12	17	3,89	FI-EW-08L-W3-SV
	.31	7251	.24	.83	1.14	.55	1.08	.47	.67	8,56	
	10	500	8	22	30	15	29	14	19	5,20	FI-EW-10L-W3-SV
	.39	7251	.31	.87	1.18	.59	1.14	.55	.75	11,44	
	12	400	10	24	32	17	29,5	17	22	7,20	FI-EW-12L-W3-SV
	.47	5800	.39	.94	1.26	.67	1.16	.67	.87	15,84	
	15	400	12	28	36	21	32,5	19	27	17,20	FI-EW-15L-W3-SV
	.59	5800	.47	1.10	1.42	.83	1.28	.75	1.06	37,84	
	18	400	15	31	40	23,5	35,5	24	32	17,70	FI-EW-18L-W3-SV
	.71	5800	.59	1.22	1.57	.93	1.40	.94	1.26	38,94	
	22	250	19	35	44	27,5	38,5	27	36	24,00	FI-EW-22L-W3-SV
	.87	3625	.75	1.38	1.73	1.08	1.52	1.06	1.42	52,80	
	28	250	24	38	47	30,5	41,5	36	41	35,70	FI-EW-28L-W3-SV
	1.10	3625	.94	1.50	1.85	1.20	1.63	1.42	1.61	78,54	
	35	250	30	45	56	34,5	51	41	50	58,10	FI-EW-35L-W3-SV
	1.38	3625	1.18	1.77	2.20	1.36	2.01	1.61	1.97	127,82	
42	250	36	51	63	40	56	50	60	87,00	FI-EW-42L-W3-SV	
1.65	3625	1.42	2.01	2.48	1.57	2.20	1.97	2.36	191,40		
S	6	800	4	23	31	16	27	12	17	4,60	FI-EW-06S-W3-SV
	.24	11603	.16	.91	1.22	.63	1.06	.47	.67	10,12	
	8	800	5	24	32	17	27,5	14	19	6,20	FI-EW-08S-W3-SV
	.31	11603	.20	.94	1.26	.67	1.08	.55	.75	13,64	
	10	800	7	25	34	17,5	30	17	22	8,80	FI-EW-10S-W3-SV
	.39	11603	.28	.98	1.34	.69	1.18	.67	.87	19,36	
	12	630	8	29	38	21,5	31	17	24	10,90	FI-EW-12S-W3-SV
	.47	9135	.31	1.14	1.50	.85	1.22	.67	.94	23,98	
	14	630	10	30	40	22	35	19	27	14,90	FI-EW-14S-W3-SV
	.55	9135	.39	1.18	1.57	.87	1.38	.75	1.06	32,78	
	16	630	11	33	43	24,5	36,5	24	30	20,10	FI-EW-16S-W3-SV
	.63	9135	.43	1.30	1.69	.96	1.44	.94	1.18	44,22	
	20	400	16	37	48	26,5	44,5	27	36	30,60	FI-EW-20S-W3-SV
	.79	5800	.63	1.46	1.89	1.04	1.75	1.06	1.42	67,32	
	25	400	20	42	54	30	50	36	46	55,40	FI-EW-25S-W3-SV
	.98	5800	.79	1.65	2.13	1.18	1.97	1.42	1.81	121,88	
	30	400	25	49	62	35,5	55	41	50	79,80	FI-EW-30S-W3-SV
	1.18	5800	.98	1.93	2.44	1.40	2.17	1.61	1.97	175,56	
38	420	32	57	72	41	63	50	60	110,30	FI-EW-38S-W3-SV	
1.50	6091	1.26	2.24	2.83	1.61	2.48	1.97	2.36	242,66		

<sup>1</sup> Approximate dimension in assembled condition.

<sup>2</sup> Weight including cutting ring and union nut on the standpipe.

<sup>3</sup> Standard scope of delivery: Fitting body assembled with cutting ring and union nut on the standpipe.



Typical application with a Straight Male Stud Fitting FI-GE-...

Please note: Standpipes are always factory-assembled with cutting rings and union nuts.



The union nut assembled on the standpipe has to be tightened by only 1/12 a turn (equivalent to 30°) beyond the fixed point.



## Adjustable Standpipe Branch Tee Type FI-ET ■ Series L / S

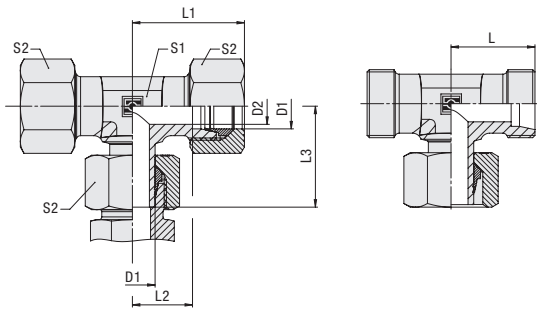

Series	Tube OD		PN (bar/PSI)	Dimensions (mm/in)							Weight (kg/lbs) ca. per 100	Ordering Codes <sup>3</sup>
	D1	D2		L	L1 <sup>1</sup>	L2	L3	S1	S2			
L	6	500	4	19	27	12	26	12	14	3,60	FI-ET-06L-W3-SV	
	.24	7251	.16	.75	1.06	.47	1.02	.47	.55	7.92		
	8	500	6	21	29	14	27,5	12	17	4,70	FI-ET-08L-W3-SV	
	.31	7251	.24	.83	1.14	.55	1.08	.47	.67	10.34		
	10	500	8	22	30	15	29	14	19	6,10	FI-ET-10L-W3-SV	
	.39	7251	.31	.87	1.18	.59	1.14	.55	.75	13.42		
	12	400	10	24	32	17	29,5	17	22	8,30	FI-ET-12L-W3-SV	
	.47	5800	.39	.94	1.26	.67	1.16	.67	.87	18.26		
	15	400	12	28	36	21	32,5	19	27	14,40	FI-ET-15L-W3-SV	
	.59	5800	.47	1.10	1.42	.83	1.28	.75	1.06	31.68		
	18	400	15	31	40	23,5	35,5	24	32	20,70	FI-ET-18L-W3-SV	
	.71	5800	.59	1.22	1.57	.93	1.40	.94	1.26	45.45		
	22	250	19	35	44	27,5	38,5	27	36	29,30	FI-ET-22L-W3-SV	
	.87	3625	.75	1.38	1.73	1.08	1.52	1.06	1.42	64.46		
	28	250	24	38	47	30,5	41,5	36	41	40,80	FI-ET-28L-W3-SV	
	1.10	3625	.94	1.50	1.85	1.20	1.63	1.42	1.61	89.76		
	35	250	30	45	56	34,5	51	41	50	65,00	FI-ET-35L-W3-SV	
	1.38	3625	1.18	1.77	2.20	1.36	2.01	1.61	1.97	143.00		
	42	250	36	51	63	40	56	50	60	87,90	FI-ET-42L-W3-SV	
1.65	3625	1.42	2.01	2.48	1.57	2.20	1.97	2.36	193.38			
S	6	800	4	23	31	16	27	12	17	5,80	FI-ET-06S-W3-SV	
	.24	11603	.16	.91	1.22	.63	1.06	.47	.67	12.76		
	8	800	5	24	32	17	27,5	14	19	7,80	FI-ET-08S-W3-SV	
	.31	11603	.20	.94	1.26	.67	1.08	.55	.75	17.16		
	10	800	7	25	34	17,5	30	17	22	10,20	FI-ET-10S-W3-SV	
	.39	11603	.28	.98	1.34	.69	1.18	.67	.87	22.44		
	12	630	8	29	38	21,5	31	17	24	13,50	FI-ET-12S-W3-SV	
	.47	9135	.31	1.14	1.50	.85	1.22	.67	.94	29.70		
	14	630	10	30	40	22	35	19	27	17,70	FI-ET-14S-W3-SV	
	.55	9135	.39	1.18	1.57	.87	1.38	.75	1.06	38.94		
	16	630	12	33	43	24,5	36,5	24	30	23,70	FI-ET-16S-W3-SV	
	.63	9135	.47	1.30	1.69	.96	1.44	.94	1.18	52.14		
	20	400	16	37	48	26,5	44,5	27	36	36,50	FI-ET-20S-W3-SV	
	.79	5800	.63	1.46	1.89	1.04	1.75	1.06	1.42	80.30		
	25	400	20	42	54	30	50	36	46	63,70	FI-ET-25S-W3-SV	
	.98	5800	.79	1.65	2.13	1.18	1.97	1.42	1.81	140.14		
	30	400	25	49	62	35,5	55	41	50	88,90	FI-ET-30S-W3-SV	
1.18	5800	.98	1.93	2.44	1.40	2.17	1.61	1.97	195.58			
38	400	32	57	72	41	63	50	60	135,80	FI-ET-38S-W3-SV		
1.50	5800	1.26	2.24	2.83	1.61	2.48	1.97	2.36	298.76			

### Ordering Codes

**\*FI-ET\*-10\*L\*-W3\*-MS+SV**

- \* Adjustable Standpipe Branch Tee **FI-ET**
- \* Outside Tube Diameter D1 (in mm) **-10**
- \* Series **L**  
Light Series  
**S**  
Heavy Series
- \* Material Code **-W3**  
Steel, zinc/nickel-plated
- Please contact STAUFF for alternative materials and surface finishings.
- \* Assembling / Kitting **-SV**  
Fitting body assembled with cutting ring and union nut on the standpipe
- MS+SV**  
Fitting body assembled with cutting rings and union nuts on all ends

### Connecting Parts

- Cutting Ring  
Type **FI-DS** Page 28
- Soft-Sealing Cutting Ring  
Type **FI-WDDS** Page 29
- Support Sleeve  
Type **FI-VH** Page 31
- STAUFF Form EVO Sealing Ring  
Type **FI-FD** Page 32
- Union Nut  
Type **FI-M** Page 33
- 37° Flared Tube Fitting Set  
Type **FI-AB** Page 37

<sup>1</sup> Approximate dimension in assembled condition.

<sup>2</sup> Weight including cutting ring and union nut on the standpipe.

<sup>3</sup> Standard scope of delivery: Fitting body assembled with cutting ring and union nut on the standpipe.



Typical application with a Straight Male Stud Fitting FI-GE...

Please note: Standpipes are always factory-assembled with cutting rings and union nuts.

The union nut assembled on the standpipe has to be tightened by only 1/12 a turn (equivalent to 30°) beyond the fixed point.



### Adjustable Standpipe Barrel Tee Type FI-EL ▪ Series L / S

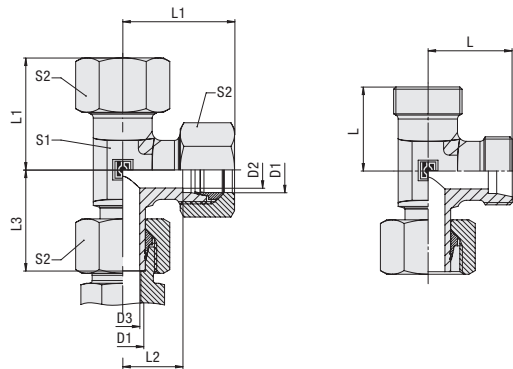

#### Ordering Codes

**\*FI-EL\*-10\*L\*-W3\*-MS+SV**

- \* Adjustable Standpipe Barrel Tee **FI-EL**
- \* Outside Tube Diameter D1 (in mm) **-10**
- \* Series Light Series **L**  
Heavy Series **S**
- \* Material Code Steel, zinc/nickel-plated **-W3**
- Please contact STAUFF for alternative materials and surface finishings.
- \* Assembling / Kitting Fitting body assembled with cutting ring and union nut on the standpipe **-SV**  
Fitting body assembled with cutting rings and union nuts on all ends **-MS+SV**

#### Connecting Parts

- Cutting Ring Type **FI-DS** Page 28
- Soft-Sealing Cutting Ring Type **FI-WDDS** Page 29
- Support Sleeve Type **FI-VH** Page 31
- STAUFF Form EVO Sealing Ring Type **FI-FD** Page 32
- Union Nut Type **FI-M** Page 33
- 37° Flared Tube Fitting Set Type **FI-AB** Page 37

Series	Tube OD	PN	Dimensions							Weight (kg/lbs) ca. per 100	Ordering Codes <sup>3</sup>
	(mm/in) D1		(bar/psi) D2	(mm/in) L	L <sup>1</sup>	L2	L3	S1	S2		
L	6	500	4	19	27	12	26	12	14	3,60	FI-EL-06L-W3-SV
	.24	7251	.16	.75	1.06	.47	1.02	.47	.55	7,92	
	8	500	6	21	29	14	27,5	12	17	4,70	FI-EL-08L-W3-SV
	.31	7251	.24	.75	1.06	.47	1.02	.47	.55	10,34	
	10	500	8	22	30	15	29	14	19	6,10	FI-EL-10L-W3-SV
	.39	7251	.31	.83	1.14	.55	1.08	.47	.67	13,42	
	12	400	10	24	32	17	29,5	17	22	8,30	FI-EL-12L-W3-SV
	.47	5800	.39	.87	1.18	.59	1.14	.55	.75	18,26	
	15	400	12	28	36	21	32,5	19	27	14,40	FI-EL-15L-W3-SV
	.59	5800	.47	.94	1.26	.67	1.16	.67	.87	31,68	
	18	400	15	31	40	23,5	35,5	24	32	20,70	FI-EL-18L-W3-SV
	.71	5800	.59	1.10	1.42	.83	1.28	.75	1.06	45,45	
	22	250	19	35	44	27,5	38,5	27	36	29,30	FI-EL-22L-W3-SV
	.87	3625	.75	1.22	1.57	.93	1.40	.94	1.26	64,46	
	28	250	24	38	47	30,5	41,5	36	41	40,80	FI-EL-28L-W3-SV
	1.10	3625	.94	1.38	1.73	1.08	1.52	1.06	1.42	89,76	
	35	250	30	45	56	34,5	51	41	50	65,00	FI-EL-35L-W3-SV
	1.38	3625	1.18	1.50	1.85	1.20	1.63	1.42	1.61	143,00	
42	250	36	51	63	40	56	50	60	87,90	FI-EL-42L-W3-SV	
1.65	3625	1.42	1.77	2.20	1.36	2.01	1.61	1.97	193,38		
S	6	800	4	23	31	16	27	12	17	5,80	FI-EL-06S-W3-SV
	.24	11603	.16	2.01	2.48	1.57	2.20	1.97	2.36	12,76	
	8	800	5	24	32	17	27,5	14	19	7,80	FI-EL-08S-W3-SV
	.31	11603	.20	.91	1.22	.63	1.06	.47	.67	17,16	
	10	800	7	25	34	17,5	30	17	22	10,20	FI-EL-10S-W3-SV
	.39	11603	.28	.94	1.26	.67	1.08	.55	.75	22,44	
	12	630	8	29	38	21,5	31	17	24	13,50	FI-EL-12S-W3-SV
	.47	9135	.31	.98	1.34	.69	1.18	.67	.87	29,70	
	14	630	10	30	40	22	35	19	27	17,70	FI-EL-14S-W3-SV
	.55	9135	.39	1.14	1.50	.85	1.22	.67	.94	38,94	
	16	630	12	33	43	24,5	36,5	24	30	23,70	FI-EL-16S-W3-SV
	.63	9135	.47	1.18	1.57	.87	1.38	.75	1.06	52,14	
	20	400	16	37	48	26,5	44,5	27	36	36,50	FI-EL-20S-W3-SV
	.79	5800	.63	1.30	1.69	.96	1.44	.94	1.18	80,30	
	25	400	20	42	54	30	50	36	46	63,70	FI-EL-25S-W3-SV
	.98	5800	.79	1.46	1.89	1.04	1.75	1.06	1.42	140,14	
	30	400	25	49	62	35,5	55	41	50	88,90	FI-EL-30S-W3-SV
	1.18	5800	.98	1.65	2.13	1.18	1.97	1.42	1.81	195,58	
38	420	32	57	72	41	63	50	60	135,80	FI-EL-38S-W3-SV	
1.50	6091	1.26	1.93	2.44	1.40	2.17	1.61	1.97	298,76		

<sup>1</sup> Approximate dimension in assembled condition.

<sup>2</sup> Weight including cutting ring and union nut on the standpipe.

<sup>3</sup> Standard scope of delivery: Fitting body assembled with cutting ring and union nut on the standpipe.



Typical application with a Straight Male Stud Fitting FI-GE-...

Please note: Standpipes are always factory-assembled with cutting rings and union nuts.

The union nut assembled on the standpipe has to be tightened by only 1/12 a turn (equivalent to 30°) beyond the fixed point.





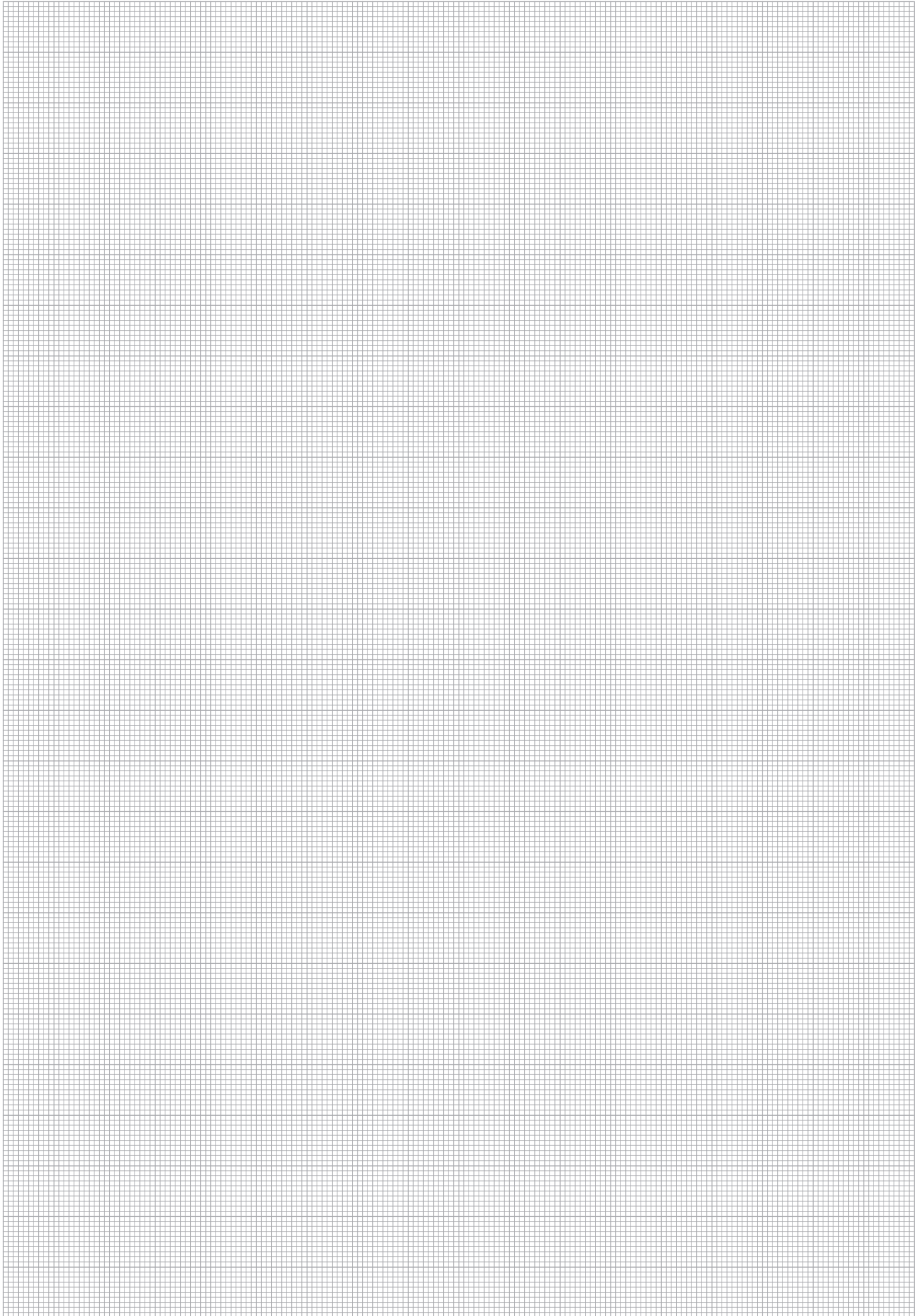

I





**Adjustable Male Stud Elbow (90°) with Lock Nut**

FI-WEE

**Whitworth Parallel Pipe Thread (BSPP) /  
O-Ring and Retaining Ring (Small)**  
FI-WEE-...-R-OK

172

**Metric Parallel Thread /  
O-Ring and Retaining Ring (Small)**  
FI-WEE-...-M-OK

174

**Metric Parallel Thread /  
O-Ring**  
FI-WEE-...-M-OR

176

**UN/UNF Thread /  
O-Ring**  
FI-WEE-...-U-OR

178

**Adjustable Male Stud Elbow (45°) with Lock Nut**

FI-VEE

**Whitworth Parallel Pipe Thread (BSPP) /  
O-Ring and Retaining Ring (Small)**  
FI-VEE-...-R-OK

173

**Metric Parallel Thread /  
O-Ring and Retaining Ring (Small)**  
FI-VEE-...-M-OK

175

**Metric Parallel Thread /  
O-Ring**  
FI-VEE-...-M-OR

177

**UN/UNF Thread /  
O-Ring**  
FI-VEE-...-U-OR

179

**Adjustable Male Stud Branch Tee with Lock Nut**

FI-TEE

**Whitworth Parallel Pipe Thread (BSPP) /  
O-Ring and Retaining Ring (Small)**  
FI-TEE-...-R-OK

173

**Metric Parallel Thread /  
O-Ring and Retaining Ring (Small)**  
FI-TEE-...-M-OK

175

**Metric Parallel Thread /  
O-Ring**  
FI-TEE-...-M-OR

177

**UN/UNF Thread /  
O-Ring**  
FI-TEE-...-U-OR

179

**Adjustable Male Stud Barrel Tee with Lock Nut**

FI-LEE

**Whitworth Parallel Pipe Thread (BSPP) /  
O-Ring and Retaining Ring (Small)**  
FI-LEE-...-R-OK

173

**Metric Parallel Thread /  
O-Ring and Retaining Ring (Small)**  
FI-LEE-...-M-OK

175

**Metric Parallel Thread /  
O-Ring**  
FI-LEE-...-M-OR

177

**UN/UNF Thread /  
O-Ring**  
FI-LEE-...-U-OR

179

**J**

**Adjustable Male Stud Elbow (90°) with Lock Nut**  
**Type FI-WEE-...-R-OK • Series L / S**

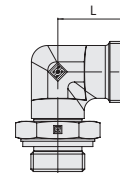
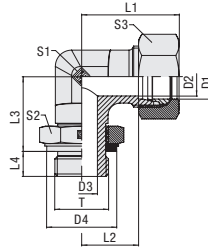

Whitworth Parallel Pipe Thread (BSP)

O-Ring and Retaining Ring (Small)

Series	Tube OD (mm/in)	PN (bar/PSI)	Dimensions (mm/in)	Dimensions											Torque (Nm/ft-lb)	Weight (kg/lbs) ca.	Ordering Codes <sup>3</sup>
				Thread T	D2	D3	D4	L	L1 <sup>1</sup>	L2	L3	L4	S1	S2			
L	6	315	G 1/8	4	4	14,8	21	29	14	20	7	14	14	14	25	4,06	FI-WEE-06LR-OK-B-W3
	.24	4568		.16	.16	.58	.83	1.14	.55	.79	.28	.55	.55	.55	18.5	8.94	
	8	315	G 1/4	6	5	19,8	23	31	16	25	9	14	19	17	50	6,34	FI-WEE-08LR-OK-B-W3
	.31	4568		.24	.20	.78	.91	1.22	.63	.98	.35	.55	.75	.67	37.0	13.95	
	10	315	G 1/4	8	5	19,8	24	32	17	27	9	19	19	19	50	9,17	FI-WEE-10LR-OK-B-W3
	.39	4568		.31	.20	.78	.94	1.26	.67	1.06	.35	.75	.75	.75	37.0	20.18	
	12	250	G 3/8	10	8	22,8	26	34	19	28	9	19	22	22	80	10,39	FI-WEE-12LR-OK-B-W3
	.47	3625		.39	.31	.90	1.02	1.34	.75	1.10	.35	.75	.87	.87	59.2	22.87	
	15	250	G 1/2	12	12	27,8	28	36	21	29	13	22	27	27	105	15,73	FI-WEE-15LR-OK-B-W3
	.59	3625		.47	.47	1.09	1.10	1.42	.83	1.14	.51	.87	1.06	1.06	77.7	34.61	
	18	250	G 1/2	15	12	27,8	31	40	23,5	33	13	27	27	32	105	22,29	FI-WEE-18LR-OK-B-W3
	.71	3625		.59	.47	1.09	1.22	1.57	.93	1.30	.51	1.06	1.06	1.26	77.7	49.04	
	22	160	G 3/4	19	16	32,8	35	44	27,5	38	13	30	36	36	220	33,01	FI-WEE-22LR-OK-B-W3
	.87	2320		.75	.63	1.29	1.38	1.73	1.08	1.50	.51	1.18	1.42	1.42	162.8	72.63	
28	160	G 1	24	20	40,8	38	47	30,5	44	15	36	41	41	370	50,60	FI-WEE-28LR-OK-B-W3	
1.10	2320		.94	.79	1.61	1.50	1.85	1.20	1.73	.59	1.42	1.61	1.61	273.8	111.32		
35	160	G 1 1/4	30	25	50,8	48	59	37,5	55	15	50	50	50	500	115,30	FI-WEE-35LR-OK-B-W3	
1.38	2320		1.18	.98	2.00	1.89	2.32	1.48	2.17	.59	1.97	1.97	1.97	370.0	253.66		
42	160	G 1 1/2	36	32	55,8	49	61	38	59	15	50	55	60	600	112,50	FI-WEE-42LR-OK-B-W3	
1.65	2320		1.42	1.26	2.20	1.93	2.40	1.50	2.32	.59	1.97	2.17	2.36	444.0	247.50		
S	6	315	G 1/4	4	5	19,8	22	30	15	25	9	14	19	17	50	6,62	FI-WEE-06SR-OK-B-W3
	.24	4568		.16	.20	.78	.87	1.18	.59	.98	.35	.55	.75	.67	37.0	14.56	
	8	315	G 1/4	5	5	19,8	24	32	17	27	9	19	19	50	9,70	FI-WEE-08SR-OK-B-W3	
	.31	4568		.20	.20	.78	.94	1.26	.67	1.06	.35	.75	.75	.75	37.0		21.34
	10	250	G 3/8	7	8	22,8	25	34	17,5	28	9	19	22	22	80	10,96	FI-WEE-10SR-OK-B-W3
	.39	3625		.28	.31	.90	.98	1.34	.69	1.10	.35	.75	.87	.87	59.2	24.12	
	12	250	G 3/8	8	8	22,8	29	38	21,5	31	9	22	22	24	80	14,98	FI-WEE-12SR-OK-B-W3
	.47	3625		.31	.31	.90	1.14	1.50	.85	1.22	.35	.87	.87	.94	59.2	32.95	
	16	250	G 1/2	12	12	27,8	33	43	24,5	33	13	27	27	30	105	23,56	FI-WEE-16SR-OK-B-W3
	.63	3625		.47	.47	1.09	1.30	1.69	.96	1.30	.51	1.06	1.06	1.18	77.7	51.84	
	20	250	G 3/4	16	16	32,8	38	49	27,5	39	12	30	36	36	220	36,41	FI-WEE-20SR-OK-B-W3
	.79	3625		.63	.63	1.29	1.50	1.93	1.08	1.54	.47	1.18	1.42	1.42	162.8	80.09	
	25	250	G 1	20	20	40,8	42	54	30	45	14	36	41	46	370	56,20	FI-WEE-25SR-OK-B-W3
	.98	3625		.79	.79	1.61	1.65	2.13	1.18	1.77	.55	1.42	1.61	1.81	273.8	123.64	
30	160	G 1 1/4	25	25	50,8	49	62	35,5	55	15	50	50	50	500	120,20	FI-WEE-30SR-OK-B-W3	
1.18	2320		.98	.98	2.00	1.93	2.44	1.40	2.17	.59	1.97	1.97	1.97	370.0	264.44		
38	160	G 1 1/2	32	32	55,8	50	65	34	59	15	50	55	60	600	120,30	FI-WEE-38SR-OK-B-W3	
1.50	2320		1.26	1.26	2.20	1.97	2.56	1.34	2.32	.59	1.97	2.17	2.36	444.0	264.66		

<sup>1</sup> Approximate dimension in assembled condition.

<sup>2</sup> Weight excluding cutting ring and union nut.

<sup>3</sup> Standard scope of delivery: Fitting body only.

Standard seal material is NBR (Buna-N®).

Male stud acc. to ISO 1179-3 (Type H)  
 Port acc. to ISO 1179-1

Torque recommendations for Steel mating material.

Male threaded studs were designed for female threaded ports in components made of steel. For applications with components made of softer mating materials (e.g. Aluminium), the use of connectors with additionally rolled male threads is recommended.

Please contact STAUFF prior to the assembly for further information.

**Ordering Codes**

**\*FI-WEE\*-10\*L\*R\*-OK\*-B\*-W3\*-MS**

- \* Adjustable Male Stud Elbow (90°) with Lock Nut **FI-WEE**
- \* Outside Tube Diameter (in mm) **-10**
- \* Series **L** Light Series  
**S** Heavy Series
- \* Thread Type **R** Whitworth Parallel Pipe Thread (BSP)

- \* Seal Type **-OK** O-Ring and Retaining Ring (Small)
- \* Seal Material **-B** NBR (Buna-N®)  
**-V** FKM (Viton®)  
**-E** EPDM
- \* Material Code **-W3** Steel, zinc/nickel-plated

- \* Assembling / Kitting **---** Fitting body only
- MS** Fitting body supplied with cutting ring and union nut
- MSV** Fitting body supplied with soft-sealing cutting ring and union nut

If required, please indicate special sizes, e.g. R1/8!

Please contact STAUFF for alternative materials and surface finishings.



**Adjustable Male Stud Elbow (45°) with Lock Nut  
Type FI-VEE-...-R-OK • Series L / S**
**Adjustable Male Stud Branch Tee with Lock Nut  
Type FI-TEE-...-R-OK • Series L / S**
**Adjustable Male Stud Barrel Tee with Lock Nut  
Type FI-LEE-...-R-OK • Series L / S**
**Type FI-VEE-...-R-OK**

Whitworth Parallel Pipe Thread (BSPP)  
O-Ring and Retaining Ring (Small)

Male stud acc. to ISO 1179-3 (Type H)  
Port acc. to ISO 1179-1

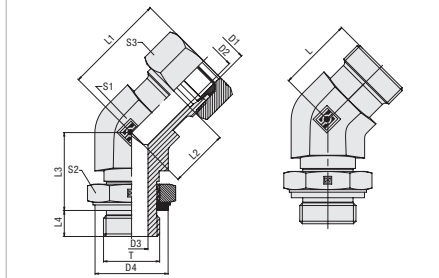

Dimensions L, L1, L2 and L3 deviating from the dimension table on the left.

**Type FI-TEE-...-R-OK**

Whitworth Parallel Pipe Thread (BSPP)  
O-Ring and Retaining Ring (Small)

Male stud acc. to ISO 1179-3 (Type H)  
Port acc. to ISO 1179-1

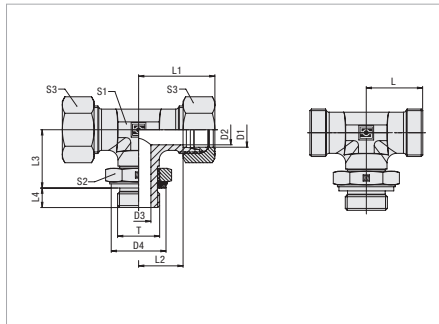
**Type FI-LEE-...-R-OK**

Whitworth Parallel Pipe Thread (BSPP)  
O-Ring and Retaining Ring (Small)

Male stud acc. to ISO 1179-3 (Type H)  
Port acc. to ISO 1179-1

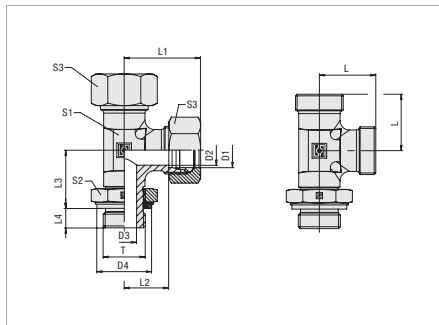

Male threaded studs were designed for female threaded ports in components made of steel. For applications with components made of softer mating materials (e.g. Aluminium), the use of connectors with additionally rolled male threads is recommended.

Please contact STAUFF prior to the assembly for further information.

**Connecting Parts**

Cutting Ring  
Type **FI-DS** Page 28



Soft-Sealing Cutting Ring  
Type **FI-WDDS** Page 29



Support Sleeve  
Type **FI-VH** Page 31



STAUFF Form EVO Sealing Ring  
Type **FI-FD** Page 32



Union Nut  
Type **FI-M** Page 33



37° Flared Tube Fitting Set  
Type **FI-AB** Page 37

**Spare Parts / Accessories**



O-Ring  
Type **O-RING** Page 239



Retaining Ring (Small)  
Type **FI-KR** Page 247

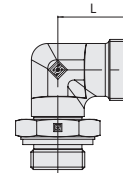
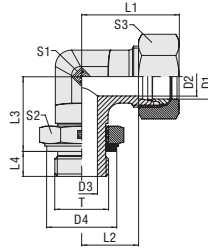

### Adjustable Male Stud Elbow (90°) with Lock Nut Type FI-WEE-...-M-OK • Series L / S



Metric Parallel Thread

O-Ring and Retaining Ring (Small)

Series	Tube OD (mm/in)	PN (bar/PSI)	Dimensions (mm/in)	Metric Parallel Thread											Torque (N·m/ft·lb)	Weight (kg/lbs) ca.	Ordering Codes <sup>3</sup>
				Thread T	D2	D3	D4	L	L1 <sup>1</sup>	L2	L3	L4	S1	S2			
L	6	315	M 10 x 1	4	4	14,8	21	29	14	20	7	14	14	14	18	4,42	FI-WEE-06LM-OK-B-W3
	.24	4568		.16	.16	.58	.83	1.14	.55	.79	.28	.55	.55	.55	13.3	9.72	
	8	315		M 12 x 1,5	6	4	17,8	23	31	16	23,5	10	14	17	35	5,14	
	.31	4568	.24		.16	.70	.91	1.22	.63	.93	.39	.55	.67	.67	25.9	11.31	
	10	315	M 14 x 1,5	8	5	19,8	24	32	17	27	10	19	19	19	55	8,60	FI-WEE-10LM-OK-B-W3
	.39	4568		.31	.20	.78	.94	1.26	.67	1.06	.39	.75	.75	.75	40.7	18.92	
	12	315	M 16 x 1,5	10	7	22,8	26	34	19	27	10	19	22	22	80	10,44	FI-WEE-12LM-OK-B-W3
	.47	4568		.39	.28	.90	1.02	1.34	.75	1.06	.39	.75	.87	.87	59.2	22.96	
	15	315	M 18 x 1,5	12	8	24,8	28	36	21	29	11	22	24	27	105	14,89	FI-WEE-15LM-OK-B-W3
	.59	4568		.47	.31	.98	1.10	1.42	.83	1.14	.43	.87	.94	1.06	77.7	32.75	
	18	250	M 22 x 1,5	15	12	27,8	31	40	23,5	36	12	27	27	32	125	23,93	FI-WEE-18LM-OK-B-W3
	.71	3625		.59	.47	1.09	1.22	1.57	.93	1.42	.47	1.06	1.06	1.26	92.5	52.65	
	22	160	M 27 x 2	19	16	32,8	35	44	27,5	38	14	30	32	36	220	30,36	FI-WEE-22LM-OK-B-W3
	.87	2320		.75	.63	1.29	1.38	1.73	1.08	1.50	.55	1.18	1.26	1.42	162.8	66.79	
	28	160	M 33 x 2	24	20	40,8	38	47	30,5	47	14	36	41	41	370	51,70	FI-WEE-28LM-OK-B-W3
1.10	2320	.94		.79	1.61	1.50	1.85	1.20	1.85	.55	1.42	1.61	1.61	273.8	113.74		
35	160	M 42 x 2	30	25	50,8	48	59	37,5	58	14	50	50	50	500	106,10	FI-WEE-35LM-OK-B-W3	
1.38	2320		1.18	.98	2.00	1.89	2.32	1.48	2.28	.55	1.97	1.97	1.97	370.0	233.42		
42	160	M 48 x 2	36	32	55,8	49	61	38	58,5	16	50	55	60	600	101,60	FI-WEE-42LM-OK-B-W3	
1.65	2320		1.42	1.26	2.20	1.93	2.40	1.50	2.30	.63	1.97	2.17	2.36	444.0	223.52		
S	6	315	M 12 x 1,5	4	4	17,8	22	30	15	23,5	10	14	17	35	6,43	FI-WEE-06SM-OK-B-W3	
	.24	4568		.16	.16	.70	.87	1.18	.59	.93	.39	.55	.67	.67	25.9		14.14
	8	315		M 14 x 1,5	5	5	19,8	24	32	17	27	10	19	19	55		9,06
	.31	4568	.20		.20	.78	.94	1.26	.67	1.06	.39	.75	.75	.75	40.7	19.94	
	10	315	M 16 x 1,5	7	7	22,8	25	34	17,5	26	11	19	22	80	11,02	FI-WEE-10SM-OK-B-W3	
	.39	4568		.28	.28	.90	.98	1.34	.69	1.02	.43	.75	.87	.87	59.2		24.24
	12	315	M 18 x 1,5	8	8	24,8	29	38	21,5	28	12	22	24	24	105	15,90	FI-WEE-12SM-OK-B-W3
	.47	4568		.31	.31	.98	1.14	1.50	.85	1.10	.47	.87	.94	.94	77.7	34.98	
	16	250	M 22 x 1,5	12	12	27,8	33	43	24,5	34	14	27	27	30	125	25,14	FI-WEE-16SM-OK-B-W3
	.63	3625		.47	.47	1.09	1.30	1.69	.96	1.34	.55	1.06	1.06	1.18	92.5	55.31	
	20	250	M 27 x 2	16	16	32,8	38	49	27,5	36	16	30	32	36	220	38,45	FI-WEE-20SM-OK-B-W3
	.79	3625		.63	.63	1.29	1.50	1.93	1.08	1.42	.63	1.18	1.26	1.42	162.8	84.59	
	25	250	M 33 x 2	20	20	40,8	42	54	30	45	16	36	41	46	370	53,82	FI-WEE-25SM-OK-B-W3
	.98	3625		.79	.79	1.61	1.65	2.13	1.18	1.77	.63	1.42	1.61	1.81	273.8	118.40	
	30	160	M 42 x 2	25	25	50,8	49	62	35,5	55	17	50	50	50	500	110,10	FI-WEE-30SM-OK-B-W3
1.18	2320	.98		.98	2.00	1.93	2.44	1.40	2.17	.67	1.97	1.97	1.97	370.0	242.22		
38	160	M 48 x 2	32	32	55,8	50	65	34	55,5	19	50	55	60	600	109,30	FI-WEE-38SM-OK-B-W3	
1.50	2320		1.26	1.26	2.20	1.97	2.56	1.34	2.19	.75	1.97	2.17	2.36	444.0	240.46		

<sup>1</sup> Approximate dimension in assembled condition.

<sup>2</sup> Weight excluding cutting ring and union nut.

<sup>3</sup> Standard scope of delivery: Fitting body only.

Port acc. to ISO 9974-1

Torque recommendations for Steel mating material.

Male threaded studs were designed for female threaded ports in components made of steel. For applications with components made of softer mating materials (e.g. Aluminium), the use of connectors with additionally rolled male threads is recommended.

Please contact STAUFF prior to the assembly for further information.

Standard seal material is NBR (Buna-N®).

### Ordering Codes

**\*FI-WEE\*-10\*L\*M\*-OK\*-B\*-W3\*-MS**

- \* Adjustable Male Stud Elbow (90°) with Lock Nut **FI-WEE**
- \* Outside Tube Diameter (in mm) **-10**
- \* Series Light Series **L**  
Heavy Series **S**
- \* Thread Type Metric Parallel Thread **M**

If required, please indicate special sizes, e.g. M26x1.5!

- \* Seal Type O-Ring and Retaining Ring (Small) **-OK**
- \* Seal Material NBR (Buna-N®) **-B**  
FKM (Viton®) **-V**  
EPDM **-E**
- \* Material Code Steel, zinc/nickel-plated **-W3**

Please contact STAUFF for alternative materials and surface finishings.

- \* Assembling / Kitting Fitting body only **—**
- Fitting body supplied with cutting ring and union nut **-MS**
- Fitting body supplied with soft-sealing cutting ring and union nut **-MSV**



**Adjustable Male Stud Elbow (45°) with Lock Nut**  
**Type FI-VEE-...-M-OK • Series L / S**
**Adjustable Male Stud Branch Tee with Lock Nut**  
**Type FI-TEE-...-M-OK • Series L / S**
**Adjustable Male Stud Barrel Tee with Lock Nut**  
**Type FI-LEE-...-M-OK • Series L / S**
**Type FI-VEE-...-M-OK**
**Metric Parallel Thread**  
**O-Ring and Retaining Ring (Small)**

Port acc. to ISO 9974-1

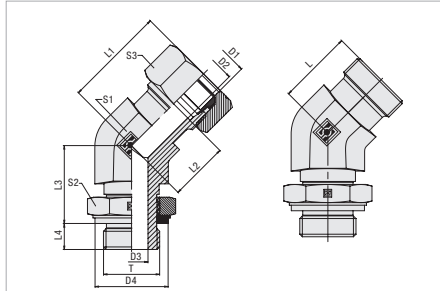

Dimensions L, L1, L2 and L3 deviating from the dimension table on the left.

**Type FI-TEE-...-M-OK**
**Metric Parallel Thread**  
**O-Ring and Retaining Ring (Small)**

Port acc. to ISO 9974-1

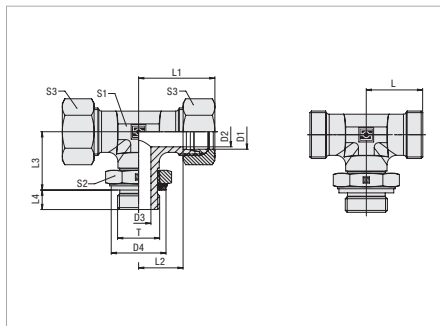
**Type FI-LEE-...-M-OK**
**Metric Parallel Thread**  
**O-Ring and Retaining Ring (Small)**

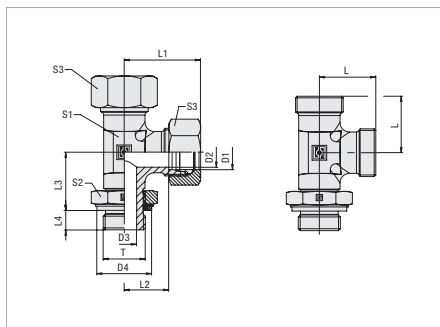

Port acc. to ISO 9974-1





Male threaded studs were designed for female threaded ports in components made of steel. For applications with components made of softer mating materials (e.g. Aluminium), the use of connectors with additionally rolled male threads is recommended.

Please contact STAUFF prior to the assembly for further information.

**Connecting Parts**

-  Cutting Ring  
Type **FI-DS** Page 28
-  Soft-Sealing Cutting Ring  
Type **FI-WDDS** Page 29
-  Support Sleeve  
Type **FI-VH** Page 31

-  STAUFF Form EVO Sealing Ring  
Type **FI-FD** Page 32
-  Union Nut  
Type **FI-M** Page 33
-  37° Flared Tube Fitting Set  
Type **FI-AB** Page 37

**Spare Parts / Accessories**

-  O-Ring  
Type **O-RING** Page 239
-  Retaining Ring (Small)  
Type **FI-KR** Page 247

**J**

**Adjustable Male Stud Elbow (90°) with Lock Nut**  
**Type FI-WEE-...-M-OR • Series L / S**

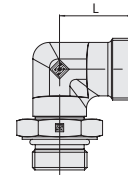
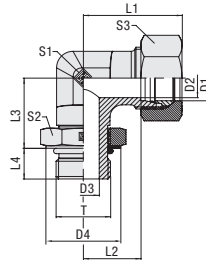

Metric Parallel Thread

O-Ring

Series	Tube OD (mm/in)	PN (bar/PSI)	Dimensions (mm/in)	Dimensions											Torque (Nm/ft-lb)	Weight (kg/lbs) ca.	Ordering Codes <sup>3</sup>
				Thread T	D2	D3	D4	L	L1 <sup>1</sup>	L2	L3	L4	S1	S2			
L	6	315	M 10 x 1	4	4	14,5	21	29	14	20	7	14	14	14	15	5,16	FI-WEE-06LM-OR-B-W3
	.24	4568		.16	.16	.57	.83	1.14	.55	.79	.28	.55	.55	.55	11.1	11.35	
	8	315	M 12 x 1,5	6	4	17,5	23	31	16	23,5	10	14	17	25	5,44	FI-WEE-08LM-OR-B-W3	
	.31	4568		.24	.16	.69	.91	1.22	.63	.93	.39	.55	.67	.67	18.5		11.96
	10	315	M 14 x 1,5	8	5	19,5	24	32	17	27	10	19	19	19	35	9,00	FI-WEE-10LM-OR-B-W3
	.39	4568		.31	.20	.77	.94	1.26	.67	1.06	.39	.75	.75	.75	25.9	19.80	
	12	315	M 16 x 1,5	10	7	22,5	26	34	19	27	10	19	22	22	40	10,23	FI-WEE-12LM-OR-B-W3
	.47	4568		.39	.28	.89	1.02	1.34	.75	1.06	.39	.75	.87	.87	29.6	22.51	
	15	315	M 18 x 1,5	12	8	24,5	28	36	21	29	11	22	24	27	45	14,59	FI-WEE-15LM-OR-B-W3
	.59	4568		.47	.31	.96	1.10	1.42	.83	1.14	.43	.87	.94	1.06	33.3	32.11	
	18	250	M 22 x 1,5	15	12	27,5	31	40	23,5	36	12	27	27	32	60	23,09	FI-WEE-18LM-OR-B-W3
	.71	3625		.59	.47	1.08	1.22	1.57	.93	1.42	.47	1.06	1.06	1.26	44.4	50.80	
	22	160	M 27 x 2	19	16	32,5	35	44	27,5	38	14	30	32	36	100	39,11	FI-WEE-22LM-OR-B-W3
	.87	2320		.75	.63	1.28	1.38	1.73	1.08	1.50	.55	1.18	1.26	1.42	74.0	86.04	
	28	160	M 33 x 2	24	20	41,5	38	47	30,5	47	14	36	41	41	160	61,54	FI-WEE-28LM-OR-B-W3
	1.10	2320		.94	.79	1.63	1.50	1.85	1.20	1.85	.55	1.42	1.61	1.61	118.4	135.38	
35	160	M 42 x 2	30	25	50,5	48	59	37,5	58	14	50	50	50	210	131,90	FI-WEE-35LM-OR-B-W3	
1.38	2320		1.18	.98	1.99	1.89	2.32	1.48	2.28	.55	1.97	1.97	1.97	155.4	290.18		
42	160	M 48 x 2	36	32	55,5	49	61	38	58,5	16	50	55	60	260	136,43	FI-WEE-42LM-OR-B-W3	
1.65	2320		1.42	1.26	2.19	1.93	2.40	1.50	2.30	.63	1.97	2.17	2.36	192.4	300.15		
S	6	315	M 12 x 1,5	4	4	17,5	22	30	15	23,5	10	14	17	35	7,62	FI-WEE-06SM-OR-B-W3	
	.24	4568		.16	.16	.69	.87	1.18	.59	.93	.39	.55	.67	.67	25.9		16.77
	8	315	M 14 x 1,5	5	5	19,5	24	32	17	27	10	19	19	45	11,98	FI-WEE-08SM-OR-B-W3	
	.31	4568		.20	.20	.77	.94	1.26	.67	1.06	.39	.75	.75	.75	33.3		26.35
	10	250	M 16 x 1,5	7	7	22,5	25	34	17,5	26	11	19	22	55	10,81	FI-WEE-10SM-OR-B-W3	
	.39	3625		.28	.28	.89	.98	1.34	.69	1.02	.43	.75	.87	.87	40.7		23.79
	12	250	M 18 x 1,5	8	8	24,5	29	38	21,5	28	12	22	24	70	15,60	FI-WEE-12SM-OR-B-W3	
	.47	3625		.31	.31	.96	1.14	1.50	.85	1.10	.47	.87	.94	.94	51.8		34.32
	16	250	M 22 x 1,5	12	12	27,5	33	43	24,5	34	14	27	27	30	100	24,52	FI-WEE-16SM-OR-B-W3
	.63	3625		.47	.47	1.08	1.30	1.69	.96	1.34	.55	1.06	1.06	1.18	74.0	53.94	
	20	250	M 27 x 2	16	16	32,5	38	49	27,5	36	16	30	32	36	170	33,16	FI-WEE-20SM-OR-B-W3
	.79	3625		.63	.63	1.28	1.50	1.93	1.08	1.42	.63	1.18	1.26	1.42	125.8	72.96	
	25	160	M 33 x 2	20	20	41,5	42	54	30	45	16	36	41	46	310	56,70	FI-WEE-25SM-OR-B-W3
	.98	2320		.79	.79	1.63	1.65	2.13	1.18	1.77	.63	1.42	1.61	1.81	229.4	124.74	
30	160	M 42 x 2	25	25	50,5	49	62	35,5	55	17	50	50	330	144,57	FI-WEE-30SM-OR-B-W3		
1.18	2320		.98	.98	1.99	1.93	2.44	1.40	2.17	.67	1.97	1.97	1.97	244.2		318.05	
38	160	M 48 x 2	32	32	55,5	50	65	34	55,5	19	50	55	60	420	152,80	FI-WEE-38SM-OR-B-W3	
1.50	2320		1.26	1.26	2.19	1.97	2.56	1.34	2.19	.75	1.97	2.17	2.36	310.8	336.17		

<sup>1</sup> Approximate dimension in assembled condition.

<sup>2</sup> Weight excluding cutting ring and union nut.

<sup>3</sup> Standard scope of delivery: Fitting body only.

Standard seal material is NBR (Buna-N®).

Male stud according to ISO 6149-2/-3  
 Port according to ISO 6149-1

Torque recommendations for Steel mating material.

Male threaded studs were designed for female threaded ports in components made of steel. For applications with components made of softer mating materials (e.g. Aluminium), the use of connectors with additionally rolled male threads is recommended.

Please contact STAUFF prior to the assembly for further information.

**Ordering Codes**

**\*FI-WEE\*-10\*L\*M\*-OR\*-B\*-W3\*-MS**

- \* Adjustable Male Stud Elbow (90°) with Lock Nut **FI-WEE**
- \* Outside Tube Diameter (in mm) **-10**
- \* Series Light Series **L**  
Heavy Series **S**
- \* Thread Type Metric Parallel Thread **M**

If required, please indicate special sizes, e.g. M26x1.5!

- \* Seal Type O-Ring **-OR**
- \* Seal Material NBR (Buna-N®) **-B**  
FKM (Viton®) **-V**  
EPDM **-E**
- \* Material Code Steel, zinc/nickel-plated **-W3**

Please contact STAUFF for alternative materials and surface finishings.

- \* Assembling / Kitting Fitting body only **—**
- Fitting body supplied with cutting ring and union nut **-MS**
- Fitting body supplied with soft-sealing cutting ring and union nut **-MSV**



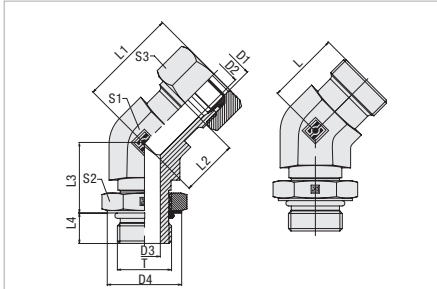

**Adjustable Male Stud Elbow (45°) with Lock Nut  
Type FI-VEE-...-M-OR • Series L / S**
**Adjustable Male Stud Branch Tee with Lock Nut  
Type FI-TEE-...-M-OR • Series L / S**
**Adjustable Male Stud Barrel Tee with Lock Nut  
Type FI-LEE-...-M-OR • Series L / S**
**Type FI-VEE-...-M-OR**
**Metric Parallel Thread  
O-Ring**

 Male stud according to ISO 6149-2/-3  
 Port according to ISO 6149-1

Dimensions L, L1, L2 and L3 deviating from the dimension table on the left.

**Type FI-TEE-...-M-OR**
**Metric Parallel Thread  
O-Ring**

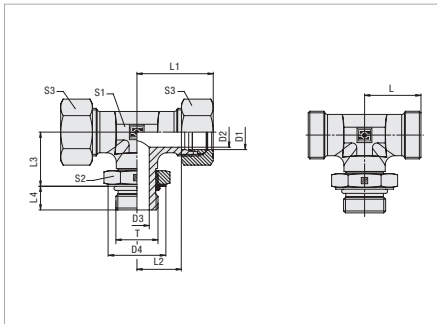

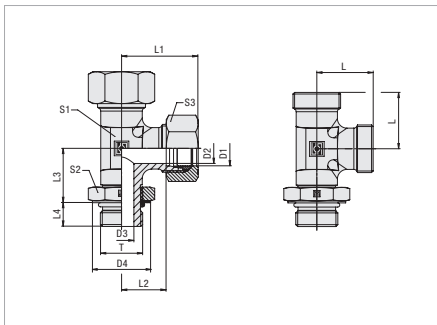
 Male stud according to ISO 6149-2/-3  
 Port according to ISO 6149-1

**Type FI-LEE-...-M-OR**
**Metric Parallel Thread  
O-Ring**



 Male stud according to ISO 6149-2/-3  
 Port according to ISO 6149-1

Male threaded studs were designed for female threaded ports in components made of steel. For applications with components made of softer mating materials (e.g. Aluminium), the use of connectors with additionally rolled male threads is recommended.

Please contact STAUFF prior to the assembly for further information.

**Connecting Parts**

-  Cutting Ring  
Type **FI-DS** Page 28
-  Soft-Sealing Cutting Ring  
Type **FI-WDDS** Page 29
-  Support Sleeve  
Type **FI-VH** Page 31

-  STAUFF Form EVO Sealing Ring  
Type **FI-FD** Page 32
-  Union Nut  
Type **FI-M** Page 33
-  37° Flared Tube Fitting Set  
Type **FI-AB** Page 37

**Spare Parts / Accessories**

-  O-Ring  
Type **O-RING** Page 239



**Adjustable Male Stud Elbow (90°) with Lock Nut**  
**Type FI-WEE-...-U • Series L / S**

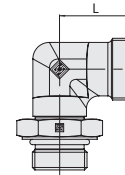
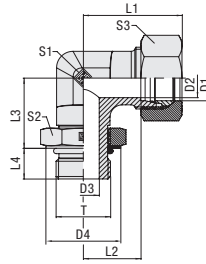

UN/UNF Thread

O-Ring

Series	Tube OD (mm/in)	PN (bar/PSI)	Dimensions (mm/in)													Torque (Nm/ft-lb)	Weight (kg/lbs) ca.	Ordering Codes <sup>3</sup>		
			Thread T	D2	D3	D4	L	L1 <sup>1</sup>	L2	L3	L4	S1	S2	S3	Thread T					
L	6	315	7/16-20 UNF	4	4,5	16,5	21	29	14	21	11	14	17	14	18	5,02	FI-WEE-06L7/16U-OR-B-W3			
	.24	4568		.16	.18	.65	.83	1.14	.55	.83	.43	.55	.67	.55	13.3	11.04				
	8	315		6	4,5	16,5	23	31	16	21	11	14	17	18	17	18		5,16		
	.31	4568	7/16-20 UNF	.24	.18	.65	.91	1.22	.63	.83	.43	.55	.67	.67	13.3	11.36	FI-WEE-08L7/16U-OR-B-W3			
				10	315	8	7,5	20,2	24	32	17	25	12	19	19	19		34	14,99	
				.39	4568	9/16-18 UNF	10	7,5	20,2	26	34	19	25,5	12	19	19		22	34	15,29
	.47	4568	9/16-18 UNF	.39	.30	.80	1.02	1.34	.75	1.00	.47	.75	.75	.87	25.1	33.63	FI-WEE-12L9/16U-OR-B-W3			
				15	315	12	10	25,7	28	36	21	30	14	22	24	27		55	15,03	
				.59	4568	3/4-16 UNF	.47	.39	1.01	1.10	1.42	.83	1.18	.55	.87	.94		1.06	40.6	33.07
	.71	3625	7/8-14 UNF	15	12,5	29,3	31	40	23,5	35	16	27	27	32	80	24,03	FI-WEE-18L7/8U-OR-B-W3			
				22	160	19	15,5	36,7	35	44	27,5	39	18	30	36	36		100	35,96	
				.87	2320	1 1/16-12 UN	.75	.61	1.44	1.38	1.73	1.08	1.54	.71	1.18	1.42		1.42	73.8	79.11
	.87	2320	1 1/16-12 UN	24	21,5	44	38	47	30,5	43	18	36	41	41	150	49,38	FI-WEE-28L1-5/16U-OR-B-W3			
				1.10	2320	1 5/16-12 UN	.94	.85	1.73	1.50	1.85	1.20	1.69	.71	1.42	1.61		1.61	110.6	108.64
				35	160	30	27,5	55	48	59	37,5	50	18	50	50	50		290	106,22	
	1.38	2320	1 5/8-12 UN	1.18	1.08	2.17	1.89	2.32	1.48	1.97	.71	1.97	1.97	1.97	213.9	233.69	FI-WEE-35L1-5/8U-OR-B-W3			
				42	160	36	33,5	62,3	49	61	37,89	52	18	50	55	60		325	101,73	
				1.65	2320	1 7/8-12 UN	1.42	1.32	2.45	1.93	2.40	1.49	2.05	.71	1.97	2.17		2.36	239.7	223.81
S	6	315	7/16-20 UNF	4	4,5	16,5	22	30	15	21	11	14	17	20	5,92	FI-WEE-06S7/16U-OR-B-W3				
	.24	4568		.16	.18	.65	.87	1.18	.59	.83	.43	.55	.67	.67	14.8		13.03			
	8	315		5	7,5	20,2	24	32	17	25	12	19	19	19	46		9,45			
	.31	4568	9/16-18 UNF	.20	.30	.80	.94	1.26	.67	.98	.47	.75	.75	.75	33.9	20.79	FI-WEE-08S9/16U-OR-B-W3			
				10	315	7	7,5	20,2	25	34	17,5	25,5	12	19	19	22		46	9,80	
				.39	4568	9/16-18 UNF	.28	.30	.80	.98	1.34	.69	1.00	.47	.75	.75		.87	33.9	21.56
	.47	4568	3/4-16 UNF	8	10	25,7	29	38	21,5	30	14	22	24	24	80	16,06	FI-WEE-12S3/4U-OR-B-W3			
				12	315	8	10	25,7	29	38	21,5	30	14	22	24	24		80	16,06	
				.59	4568	3/4-16 UNF	.31	.39	1.01	1.14	1.50	.85	1.18	.55	.87	.94		.94	59.0	35.34
	.63	3625	7/8-14 UNF	12	12,5	29,3	33	43	24,5	35	16	27	27	30	80	25,18	FI-WEE-16S7/8U-OR-B-W3			
				16	250	12	12,5	29,3	33	43	24,5	35	16	27	27	30		80	25,18	
				.79	3625	7/8-14 UNF	.47	.49	1.15	1.30	1.69	.96	1.38	.63	1.06	1.06		1.18	59.0	55.40
	.79	3625	1 1/16-12 UN	16	15,5	36,7	38	49	27,5	39	18	30	36	36	185	38,53	FI-WEE-20S1-1/16U-OR-B-W3			
				25	160	19	15,5	36,7	35	44	27,5	39	18	30	36	36		100	35,96	
				.98	2320	1 1/16-12 UN	.63	.61	1.44	1.50	1.93	1.08	1.54	.71	1.18	1.42		1.42	136.4	84.76
	.98	2320	1 1/16-12 UN	20	15,5	36,7	42	54	30	43	18	36	36	46	185	53,90	FI-WEE-25S1-1/16U-OR-B-W3			
				30	160	25	27,5	55	49	62	35,5	50	18	50	50	340		110,22		
				1.18	2320	1 5/8-12 UN	.79	.61	1.44	1.65	2.13	1.18	1.69	.71	1.42	1.42		1.81	136.4	118.58
.98	2320	1 5/8-12 UN	25	27,5	55	49	62	35,5	50	18	50	50	340	110,22	FI-WEE-30S1-5/8U-OR-B-W3					
			38	160	32	33,5	62,3	50	65	33,9	52	18	50	55		60	415	109,43		
			1.50	2320	1 7/8-12 UN	1.26	1.32	2.45	1.97	2.56	1.33	2.05	.71	1.97		2.17	2.36	306.1	240.75	

<sup>1</sup> Approximate dimension in assembled condition.

<sup>2</sup> Weight excluding cutting ring and union nut.

<sup>3</sup> Standard scope of delivery: Fitting body only.

Standard seal material is NBR (Buna-N®).

Male stud acc. to ISO 11926-2/-3  
 Port acc. to ISO 11926-1

Torque recommendations for Steel mating material.

Male threaded studs were designed for female threaded ports in components made of steel. For applications with components made of softer mating materials (e.g. Aluminium), the use of connectors with additionally rolled male threads is recommended.

Please contact STAUFF prior to the assembly for further information.

**Ordering Codes**

**\*FI-WEE\*-10\*L\*9/16\*U\*-OR\*-B\*-W3\*-MS**

- \* Adjustable Male Stud Elbow (90°) with Lock Nut **FI-WEE**
- \* Outside Tube Diameter (in mm) **-10**
- \* Series Light Series **L**  
Heavy Series **S**
- \* Thread Size acc. to dimension table **9/16**

Please always indicate thread sizes, e.g. 9/16!

- \* Thread Type UN/UNF Thread with O-Ring **U**
- \* Seal Material NBR (Buna-N®) **-B**  
FKM (Viton®) **-V**  
EPDM **-E**
- \* Material Code Steel, zinc/nickel-plated **-W3**

Please contact STAUFF for alternative materials and surface finishings.

- \* Assembling / Kitting Fitting body only **—**
- Fitting body supplied with cutting ring and union nut **-MS**
- Fitting body supplied with soft-sealing cutting ring and union nut **-MSV**

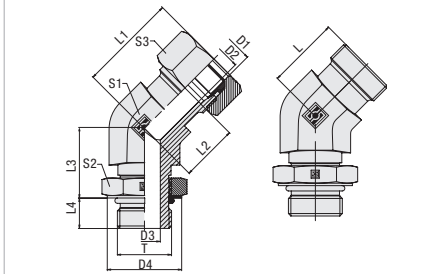

**Adjustable Male Stud Elbow (45°) with Lock Nut  
Type FI-VEE-...-U • Series L / S**
**Adjustable Male Stud Branch Tee with Lock Nut  
Type FI-TEE-...-U • Series L / S**
**Adjustable Male Stud Barrel Tee with Lock Nut  
Type FI-LEE-...-U • Series L / S**
**Type FI-VEE-...-U**
**UN/UNF Thread  
O-Ring**

 Male stud according to ISO 6149-2/-3  
 Port according to ISO 6149-1

Dimensions L, L1, L2 and L3 deviating from the dimension table on the left.

**Type FI-TEE-...-U**
**UN/UNF Thread  
O-Ring**

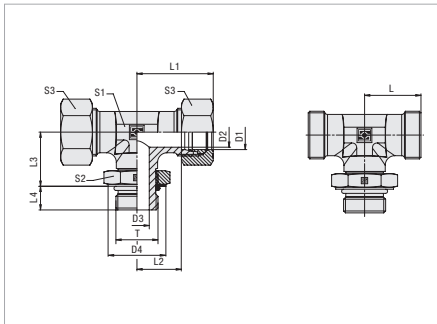
 Male stud according to ISO 6149-2/-3  
 Port according to ISO 6149-1

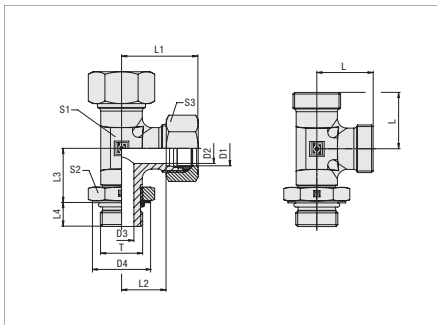
**Type FI-LEE-...-U**
**UN/UNF Thread  
O-Ring**

 Male stud according to ISO 6149-2/-3  
 Port according to ISO 6149-1

Male threaded studs were designed for female threaded ports in components made of steel. For applications with components made of softer mating materials (e.g. Aluminium), the use of connectors with additionally rolled male threads is recommended.

Please contact STAUFF prior to the assembly for further information.

**Connecting Parts**

 Cutting Ring  
 Type **FI-DS** Page 28

 Soft-Sealing Cutting Ring  
 Type **FI-WDDS** Page 29

 Support Sleeve  
 Type **FI-VH** Page 31

 STAUFF Form EVO Sealing Ring  
 Type **FI-FD** Page 32

 Union Nut  
 Type **FI-M** Page 33

 37° Flared Tube Fitting Set  
 Type **FI-AB** Page 37

**Spare Parts / Accessories**

 O-Ring  
 Type **O-RING** Page 239



**Banjo Elbow (Medium-Pressure Version)**  
 FI-RSWND

182-185

**Whitworth Parallel Pipe Thread (BSPP) /  
 External Metallic Sealing Ring**  
 FI-RSWND-...-R-DK

182

**Metric Parallel Thread /  
 External Metallic Sealing Ring**  
 FI-RSWND-...-M-DK

183

**Whitworth Parallel Pipe Thread (BSPP) /  
 Retaining Ring with Captive Seal**  
 FI-RSWND-...-R-WD

184

**Metric Parallel Thread /  
 Retaining Ring with Captive Seal**  
 FI-RSWND-...-M-WD

185

**Banjo Elbow (High-Pressure Version)**  
 FI-RSW

186-189

**Whitworth Parallel Pipe Thread (BSPP) /  
 External Metallic Sealing Ring**  
 FI-RSW-...-R-DK

186

**Metric Parallel Thread /  
 External Metallic Sealing Ring**  
 FI-RSW-...-M-DK

187

**Whitworth Parallel Pipe Thread (BSPP) /  
 Retaining Ring with Captive Seal**  
 FI-RSW-...-R-WD

188

**Metric Parallel Thread /  
 Retaining Ring with Captive Seal**  
 FI-RSW-...-M-WD

189

**Banjo Tee (High-Pressure Version)**  
 FI-RST

190-193

**Whitworth Parallel Pipe Thread (BSPP) /  
 External Metallic Sealing Ring**  
 FI-RST-...-R-DK

190

**Metric Parallel Thread /  
 External Metallic Sealing Ring**  
 FI-RST-...-M-DK

191

**Whitworth Parallel Pipe Thread (BSPP) /  
 Retaining Ring with Captive Seal**  
 FI-RST-...-R-WD

192

**Metric Parallel Thread /  
 Retaining Ring with Captive Seal**  
 FI-RST-...-M-WD

193

**K**

**Banjo Elbow (Medium-Pressure Version)**  
**Type FI-RSND-...-R-DK • Series LL / L / S**

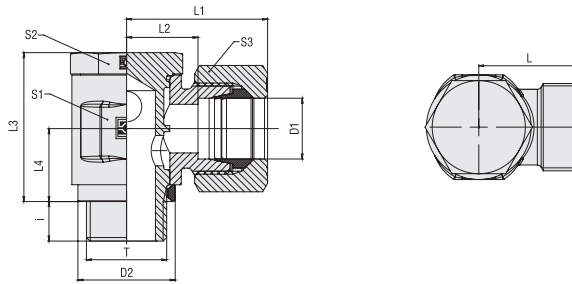

**Whitworth Parallel Pipe Thread (BSPP)**

**External Metallic Sealing Ring**

**Ordering Codes**

**\*FI-RSND\*-10\*L\*R\*-DK\*-W3\*-MS**

\* Banjo Elbow (Medium-Pressure Version) **FI-RSND**

\* Outside Tube Diameter D1 (in mm) **-10**

\* Series Extra-Light Series **LL**  
 Light Series **L**  
 Heavy Series **S**

\* Thread Type Whitworth Parallel Pipe Thread (BSPP) **R**

If required, please indicate special sizes, e.g. R1/8!

\* Seal Type External Metallic Sealing Ring **-DK**

\* Material Code Steel, zinc/nickel-plated **-W3**

Please contact STAUFF for alternative materials and surface finishings.

\* Assembling / Kitting Fitting body only **—**

Fitting body supplied with cutting ring and union nut **-MS**

Fitting body supplied with soft-sealing cutting ring and union nut **-MSV**

**Connecting Parts**

-  Cutting Ring Type **FI-DS** Page 28
-  Soft-Sealing Cutting Ring Type **FI-WDDS** Page 29
-  Support Sleeve Type **FI-VH** Page 31
-  STAUFF Form EVO Sealing Ring Type **FI-FD** Page 32
-  Union Nut Type **FI-M** Page 33
-  37° Flared Tube Fitting Set Type **FI-AB** Page 37

**Spare Parts / Accessories**

-  External Metallic Sealing Ring Type **FI-DKR** Page 244

Series	Tube OD (mm/in)	PB (°B/PS)	Dimensions (mm/in)											Weight (kg/lbs) ca. per 100	Ordering Codes <sup>3</sup>	
			Thread	T	D2	L	L1 <sup>1</sup>	L2	L3	L4	i	S1	S2			S3
LL	4	100	G 1/8	13	15,5	21	11,5	21	10	6	14	14	10	2,85	FI-RSND-04LLR-DK-W3	
	.16	1450		.51	.61	.83	.45	.83	.39	.24	.55	.55	.39	6,27		
	6	100	G 1/8	13	15,5	21	10	21	10	6	14	14	12	2,85	FI-RSND-06LLR-DK-W3	
	.24	1450		.51	.61	.83	.39	.83	.39	.24	.55	.55	.47	6,27		
	8	100	G 1/8	13	16,5	23	11	21	10	6	14	14	14	2,93	FI-RSND-08LLR-DK-W3	
	.31	1450		.51	.65	.91	.43	.83	.39	.24	.55	.55	.55	6,45		
L	6	250	G 1/8	13	18,5	25	11,5	21	10	6	14	14	14	3,15	FI-RSND-06LR-DK-W3	
	.24	3625		.51	.73	.98	.45	.83	.39	.24	.55	.55	.55	6,93		
	8	250	G 1/4	17,7	20	26	13	26	12	10	17	19	17	5,85	FI-RSND-08LR-DK-W3	
	.31	3625		.70	.79	1.02	.51	1.02	.47	.39	.67	.75	.67	12,88		
	10	250	G 1/4	17,7	22	30	15	27	13	9	19	19	19	6,95	FI-RSND-10LR-DK-W3	
	.39	3625		.70	.87	1.18	.59	1.06	.51	.35	.75	.75	.75	15,29		
	10	160	G 3/8	22	23	31	16	32	15	9	22	22	19	10,11	FI-RSND-10LR3/8-DK-W3	
	.39	2320		.87	.91	1.22	.63	1.26	.59	.35	.87	.87	.75	22,29		
	12	160	G 1/4	17,7	23	30	16	28	13	9	22	19	22	8,23	FI-RSND-12LR1/4-DK-W3	
	.47	2320		.70	.91	1.18	.63	1.10	.51	.35	.87	.75	.87	18,14		
	12	250	G 3/8	22	23	31	16	32	15	9	22	22	22	6,77	FI-RSND-12LR-DK-W3	
	.47	3625		.87	.91	1.22	.63	1.26	.59	.35	.87	.87	.87	14,90		
	12	160	G 1/2	26	26,5	34	19,5	37,5	18	11	27	27	22	16,42	FI-RSND-12LR1/2-DK-W3	
	.47	2320		1.02	1.04	1.34	.77	1.48	.71	.43	1.06	1.06	.87	36,20		
	15	160	G 1/2	26	26,5	35	19,5	37,5	18	11	27	27	27	17,36	FI-RSND-15LR-DK-W3	
	.59	2320		1.02	1.04	1.38	.77	1.48	.71	.43	1.06	1.06	1.06	38,18		
	18	160	G 1/2	26	27	36	19,5	44,5	21,5	11	30	27	32	21,47	FI-RSND-18LR-DK-W3	
	.71	2320		1.02	1.06	1.42	.77	1.75	.85	.43	1.18	1.06	1.26	47,23		
	22	160	G 3/4	32	32	41	24,5	49	24	13	36	32	36	30,63	FI-RSND-22LR-DK-W3	
	.87	2320		1.26	1.26	1.61	.96	1.93	.94	.51	1.42	1.26	1.42	67,38		
	S	6	250	G 1/4	17,7	21,5	29	14,5	26	12	10	17	19	17	6,23	FI-RSND-06SR-DK-W3
		.24	3625		.70	.85	1.14	.57	1.02	.47	.39	.67	.75	.67	13,70	
		8	250	G 1/4	17,7	23	29	16	27	13	9	19	19	19	7,47	FI-RSND-08SR-DK-W3
		.31	3625		.70	.91	1.14	.63	1.06	.51	.35	.75	.75	.75	16,43	
10		250	G 3/8	22	23,5	32	16	32	15	9	22	22	22	10,92	FI-RSND-10SR-DK-W3	
.39		3625		.87	.93	1.26	.63	1.26	.59	.35	.87	.87	.87	24,03		
12		250	G 3/8	22	26	34	18,5	37	18	9	24	24	24	14,87	FI-RSND-12SR-DK-W3	
.47		3625		.87	1.02	1.34	.73	1.46	.71	.35	.94	.94	.94	32,71		
14		160	G 1/2	26	28,5	39	20,5	37,5	18	11	27	27	27	18,58	FI-RSND-14SR-DK-W3	
.55		2320		1.02	1.12	1.54	.81	1.48	.71	.43	1.06	1.06	1.06	40,88		
16		160	G 1/2	26	30	40	21,5	44,5	21,5	11	30	27	30	22,48	FI-RSND-16SR-DK-W3	
.63		2320		1.02	1.18	1.57	.85	1.75	.85	.43	1.18	1.06	1.18	49,45		
20		160	G 3/4	32	34	45	23,5	49	24	13	36	32	36	32,20	FI-RSND-20SR-DK-W3	
.79		2320		1.26	1.34	1.77	.93	1.93	.94	.51	1.42	1.26	1.42	70,84		

<sup>1</sup> Approximate dimension in assembled condition.

<sup>2</sup> Weight excluding cutting ring and union nut.

<sup>3</sup> Standard scope of delivery: Fitting body only.

Port acc. to DIN 3852-2 (Form X) / ISO 1179-1

Male threaded studs were designed for female threaded ports in components made of steel. For applications with components made of softer mating materials (e.g. Aluminium), the use of connectors with additionally rolled male threads is recommended.

Please contact STAUFF prior to the assembly for further information.

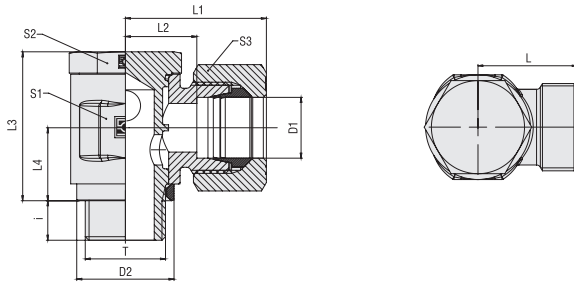

## Banjo Elbow (Medium-Pressure Version) Type FI-RSWND-...-M-DK ■ Series LL / L / S

**External Metallic Sealing Ring**
**Metric Parallel Thread**

Series	Tube OD (mm/in)	PB (bar/psi)	Dimensions (mm/in)											Weight (kg/lbs) ca. per 100	Ordering Codes <sup>3</sup>
			Thread	T	D2	L	L1 <sup>1</sup>	L2	L3	L4	i	S1	S2		
LL	4	100	M 8 x 1	10,8	15,5	21	11,5	17	8	6	14	12	10	2,66	FI-RSWND-04LLM-DK-W3
	.16	1450		.43	.61	.83	.45	.67	.31	.24	.55	.47	.39	5,85	
	6	100	M 10 x 1	13	15,5	21	10	21	10	6	14	14	12	2,86	FI-RSWND-06LLM-DK-W3
	.24	1450		.51	.61	.83	.39	.83	.39	.24	.55	.55	.47	6,30	
	8	100	M 10 x 1	13	16,5	23	11	21	10	6	14	14	14	2,94	FI-RSWND-08LLM-DK-W3
.31	1450	.51		.65	.91	.43	.83	.39	.24	.55	.55	.55	6,47		
L	6	250	M 10 x 1	13	18,5	26	11,5	21	10	6	14	14	14	3,16	FI-RSWND-06LM-DK-W3
	.24	3625		.51	.73	1.02	.45	.83	.39	.24	.55	.55	.55	6,95	
	8	250	M 12 x 1,5	17,8	20	28	13	25	12	9	17	17	17	5,02	FI-RSWND-08LM-DK-W3
	.31	3625		.70	.79	1.10	.51	.98	.47	.35	.67	.67	.67	11,04	
	10	250	M 14 x 1,5	17,8	22	30	15	27	13	9	19	19	19	7,02	FI-RSWND-10LM-DK-W3
	.39	3625		.70	.87	1.18	.59	1.06	.51	.35	.75	.75	.75	15,44	
	12	250	M 16 x 1,5	21,5	23	31	16	32	15	9	22	22	22	6,63	FI-RSWND-12LM-DK-W3
	.47	3625		.85	.91	1.22	.63	1.26	.59	.35	.87	.87	.87	14,58	
	12	160	M 18 x 1,5	23	25	33	18	37	18,5	9	24	24	22	12,70	FI-RSWND-12LM18x1.5-DK-W3
	.47	2320		.91	.98	1.30	.71	1.46	.73	.35	.94	.94	.87	28,00	
	15	160	M 18 x 1,5	23	25	33	18	37	18	9	24	24	27	13,44	FI-RSWND-15LM-DK-W3
	.59	2320		.91	.98	1.30	.71	1.46	.71	.35	.94	.94	1.06	29,56	
	18	160	M 22 x 1,5	27	27	36	19,5	44,5	21,5	11	30	27	32	22,82	FI-RSWND-18LM-DK-W3
	.71	2320		1.06	1.06	1.42	.77	1.75	.85	.43	1.18	1.06	1.26	50,20	
	22	160	M 26 x 1,5	31	32	41	24,5	49	24	13	36	32	36	30,46	FI-RSWND-22LM-DK-W3
.87	2320	1.22		1.26	1.61	.96	1.93	.94	.51	1.42	1.26	1.42	67,01		
S	6	250	M 12 x 1,5	17,8	21,5	29	14,5	25	12	9	17	17	17	5,39	FI-RSWND-06SM-DK-W3
	.24	3625		.70	.85	1.14	.57	.98	.47	.35	.67	.67	.67	11,86	
	8	250	M 14 x 1,5	17,8	23	31	16	27	13	9	19	19	19	7,54	FI-RSWND-08SM-DK-W3
	.31	3625		.70	.91	1.22	.63	1.06	.51	.35	.75	.75	.75	16,58	
	10	250	M 16 x 1,5	21,5	23,5	32,5	16	32	15	9	22	22	22	10,78	FI-RSWND-10SM-DK-W3
	.39	3625		.85	.93	1.28	.63	1.26	.59	.35	.87	.87	.87	23,71	
	12	250	M 18 x 1,5	23	25	34	17,5	37	18	9	24	24	24	13,70	FI-RSWND-12SM-DK-W3
	.47	3625		.91	.98	1.34	.69	1.46	.71	.35	.94	.94	.94	30,14	
	14	160	M 20 x 1,5	26	28,5	38,5	20,5	37	18	11	27	27	27	17,94	FI-RSWND-14SM-DK-W3
	.55	2320		1.02	1.12	1.52	.81	1.46	.71	.43	1.06	1.06	1.06	39,47	
16	160	M 22 x 1,5	27	30	40	21,5	44,5	21,5	11	30	27	30	23,83	FI-RSWND-16SM-DK-W3	
.63	2320		1.06	1.18	1.57	.85	1.75	.85	.43	1.18	1.06	1.18	52,42		
20	160	M 27 x 2	32	34	45	23,5	49	24	13	36	32	36	33,34	FI-RSWND-20SM-DK-W3	
.79	2320		1.26	1.34	1.77	.93	1.93	.94	.51	1.42	1.26	1.42	73,35		

<sup>1</sup> Approximate dimension in assembled condition.

<sup>2</sup> Weight excluding cutting ring and union nut.

<sup>3</sup> Standard scope of delivery: Fitting body only.

Port acc. to DIN 3852-1 (Form X) / ISO 9974-1

Male threaded studs were designed for female threaded ports in components made of steel. For applications with components made of softer mating materials (e.g. Aluminium), the use of connectors with additionally rolled male threads is recommended.

Please contact STAUFF prior to the assembly for further information.

**Ordering Codes**
**\*FI-RSWND\*-10\*L\*M\*-DK\*-W3\*-MS**

 \* Banjo Elbow (Medium-Pressure Version) **FI-RSWND**

 \* Outside Tube Diameter D1 (in mm) **-10**

 \* Series **LL**  
 Extra-Light Series  
**L**  
 Light Series  
**S**  
 Heavy Series

 \* Thread Type **M**  
 Metric Parallel Thread

If required, please indicate special sizes, e.g. M12x1.5!

 \* Seal Type **-DK**  
 External Metallic Sealing Ring

 \* Material Code **-W3**  
 Steel, zinc/nickel-plated

Please contact STAUFF for alternative materials and surface finishings.

 \* Assembling / Kitting **—**  
 Fitting body only

**-MS**  
 Fitting body supplied with cutting ring and union nut

**-MSV**  
 Fitting body supplied with soft-sealing cutting ring and union nut

**Connecting Parts**

	Cutting Ring Type <b>FI-DS</b>	Page 28
	Soft-Sealing Cutting Ring Type <b>FI-WDDS</b>	Page 29
	Support Sleeve Type <b>FI-VH</b>	Page 31
	STAUFF Form EVO Sealing Ring Type <b>FI-FD</b>	Page 32
	Union Nut Type <b>FI-M</b>	Page 33
	37° Flared Tube Fitting Set Type <b>FI-AB</b>	Page 37

**Spare Parts / Accessories**

	External Metallic Sealing Ring Type <b>FI-DKR</b>	Page 244
--	--	----------



**Banjo Elbow (Medium-Pressure Version)**  
**Type FI-RSND-...-R-WD ▪ Series LL / L / S**

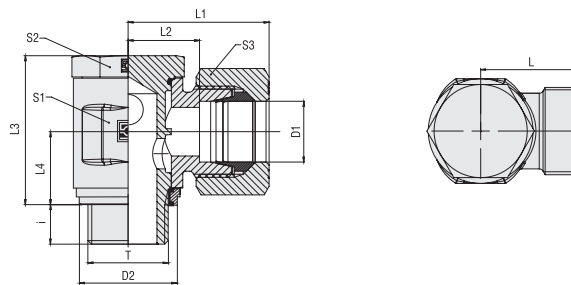

**Whitworth Parallel Pipe Thread (BSPP)**

**Retaining Ring with Captive Seal**

**Ordering Codes**

- \*FI-RSND\*-10\*L\*R\*-WD\*-B\*-W3\*-MS**
- \* Banjo Elbow (Medium-Pressure Version) FI-RSND**
- \* Outside Tube Diameter D1 (in mm) -10**
- \* Series**
  - Extra-Light Series **LL**
  - Light Series **L**
  - Heavy Series **S**
- \* Thread Type**
  - Whitworth Parallel Pipe Thread (BSPP) **R**
- If required, please indicate special sizes, e.g. R1/8!
- \* Seal Type** Retaining Ring with Captive Seal **-WD**
- \* Seal Material**
  - NBR (Buna-N®) **-B**
  - FKM (Viton®) **-V**
  - EPDM **-E**
- \* Material Code** Steel, zinc/nickel-plated **-W3**
- Please contact STAUFF for alternative materials and surface finishings.
- \* Assembling / Kitting**
  - Fitting body only **—**
  - Fitting body supplied with cutting ring and union nut **-MS**
  - Fitting body supplied with soft-sealing cutting ring and union nut **-MSV**

Series	Tube OD (mm/in)	PB (mm/in)	Dimensions (mm/in)											Weight (kg/lbs) ca. per 100	Ordering Codes <sup>3</sup>
			D1	Thread	T	D2	L	L1 <sup>1</sup>	L2	L3	L4	i	S1		
LL	6	100	G 1/8	14,9	15,5	24	10	21	10	6	14	14	14	2,70	FI-RSND-06LLR-WD-B-W3
	.24	1450		.59	.61	.94	.39	.83	.39	.24	.55	.55	.55	5,95	
	8	100	G 1/8	14,9	16,5	26	11	21	10	6	14	14	14	2,80	
L	.31	1450	G 1/8	.59	.65	1.02	.43	.83	.39	.24	.55	.55	.55	6,17	FI-RSND-08LLR-WD-B-W3
	6	250	G 1/8	14,9	18,5	25	11,5	21	10	6	14	14	14	3,07	FI-RSND-06LR-WD-B-W3
	.24	3625		.59	.73	.98	.45	.83	.39	.24	.55	.55	.55	6,75	
	8	250	G 1/4	18,8	20	26	13	26	12	10	17	19	17	5,97	FI-RSND-08LR-WD-B-W3
	.31	3625	G 1/4	.74	.79	1.02	.51	1.02	.47	.39	.67	.75	.67	13,14	
	10	250	G 1/4	18,8	22	30	15	27	13	9	19	19	19	7,60	FI-RSND-10LR-WD-B-W3
	.39	3625	G 1/4	.74	.87	1.18	.59	1.06	.51	.35	.75	.75	.75	16,71	
	10	250	G 3/8	22,8	23	31	16	33	15	8	22	22	19	9,95	FI-RSND-10LR3/8-WD-B-W3
	.39	3625	G 3/8	.90	.91	1.22	.63	1.30	.59	.31	.87	.87	.75	21,94	
	12	250	G 1/4	18,8	16	30	16	28,2	13	9,5	22	19	22	8,27	FI-RSND-12LR1/4-WD-B-W3
	.47	3625	G 1/4	.74	.63	1.18	.63	1.11	.51	.37	.87	.75	.87	18,23	
	12	250	G 3/8	22,8	23	31	16	32	15	9	22	22	22	10,45	FI-RSND-12LR-WD-B-W3
	.47	3625	G 3/8	.90	.91	1.22	.63	1.26	.59	.35	.87	.87	.87	22,99	
	15	160	G 1/2	27,9	26,5	35	19,5	37,5	18	11	27	27	27	18,00	FI-RSND-15LR-WD-B-W3
	.59	2320	G 1/2	1.10	1.04	1.38	.77	1.48	.71	.43	1.06	1.06	1.06	39,59	
18	250	G 1/2	27,9	27	36	19,5	44,5	21,5	11	30	27	32	22,31	FI-RSND-18LR-WD-B-W3	
.71	3625	G 1/2	1.10	1.06	1.42	.77	1.75	.85	.43	1.18	1.06	1.26	49,08		
22	160	G 3/4	32,9	32	41	24,5	49	24	13	36	32	36	31,05	FI-RSND-22LR-WD-B-W3	
.87	2320	G 3/4	1.3	1.26	1.61	.96	1.93	.94	.51	1.42	1.26	1.42	68,30		
S	6	250	G 1/4	18,8	21,5	29	14,5	26	12	10	17	19	17	6,34	FI-RSND-06SR-WD-B-W3
	.24	3625	G 1/4	.74	.85	1.14	.57	1.02	.47	.39	.67	.75	.67	13,96	
	8	250	G 1/4	18,8	23	29	16	27	13	9	19	19	19	7,60	FI-RSND-08SR-WD-B-W3
	.31	3625	G 1/4	.74	.91	1.14	.63	1.06	.51	.35	.75	.75	.75	16,71	
	10	250	G 3/8	22,8	23,5	32	16	32	15	9	22	22	22	10,89	FI-RSND-10SR-WD-B-W3
	.39	3625	G 3/8	.90	.93	1.26	.63	1.26	.59	.35	.87	.87	.87	23,96	
	12	250	G 3/8	22,8	26	34	18,5	37	18	9	24	24	24	14,51	FI-RSND-12SR-WD-B-W3
	.47	3625	G 3/8	.90	1.02	1.34	.73	1.46	.71	.35	.94	.94	.94	31,92	
	14	160	G 1/2	27,9	28,5	39	20,5	37,5	18	11	27	27	27	18,77	FI-RSND-14SR-WD-B-W3
	.55	2320	G 1/2	1.10	1.12	1.54	.81	1.48	.71	.43	1.06	1.06	1.06	41,30	
16	160	G 1/2	27,9	30	40	21,5	44,5	21,5	11	30	27	30	23,32	FI-RSND-16SR-WD-B-W3	
.63	2320	G 1/2	1.10	1.18	1.57	.85	1.75	.85	.43	1.18	1.06	1.18	51,29		
20	160	G 3/4	32,9	34	45	23,5	49	24	13	36	32	36	32,63	FI-RSND-20SR-WD-B-W3	
.79	2320	G 3/4	1.30	1.34	1.77	.93	1.93	.94	.51	1.42	1.26	1.42	71,79		

<sup>1</sup> Approximate dimension in assembled condition.

<sup>2</sup> Weight excluding cutting ring and union nut.

<sup>3</sup> Standard scope of delivery: Fitting body only.

Standard seal material is NBR (Buna-N®).

Port acc. to DIN 3852-2 (Form X) / ISO 1179-1



Male threaded studs were designed for female threaded ports in components made of steel. For applications with components made of softer mating materials (e.g. Aluminium), the use of connectors with additionally rolled male threads is recommended.

Please contact STAUFF prior to the assembly for further information.

**Connecting Parts**

-  Cutting Ring  
Type **FI-DS** Page 28
-  Soft-Sealing Cutting Ring  
Type **FI-WDDS** Page 29
-  Support Sleeve  
Type **FI-VH** Page 31
-  STAUFF Form EVO Sealing Ring  
Type **FI-FD** Page 32
-  Union Nut  
Type **FI-M** Page 33
-  37° Flared Tube Fitting Set  
Type **FI-AB** Page 37

**Spare Parts / Accessories**

-  Retaining Ring with Captive Seal  
Type **FI-DIR** Page 245
-  O-Ring  
Type **O-RING** Page 239



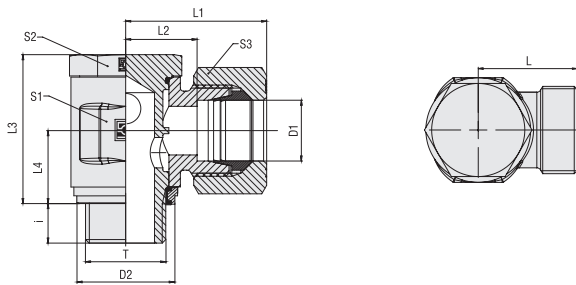

**Banjo Elbow (Medium-Pressure Version)  
Type FI-RSWND-...-M-WD ■ Series LL / L / S**

**Retaining Ring with Captive Seal**
**Metric Parallel Thread**

Series	Tube OD (mm/in)	PB (bar/psi)	Dimensions (mm/in)											Weight (kg/lbs) ca. per 100	Ordering Codes <sup>3</sup>
			Thread	T	D2	L	L <sup>1</sup>	L2	L3	L4	i	S1	S2		
LL	6	100	M 10 x 1	14,9	15,5	24	10	21	10	6	14	14	14	2,70	FI-RSWND-06LLM-WD-B-W3
	.24	1450		.59	.61	.94	.39	.83	.39	.24	.55	.55	.55	5,95	
	8	100	M 10 x 1	14,9	16,5	26	11	21	10	6	14	14	14	2,80	
.31	1450		.59	.65	1.02	.43	.83	.39	.24	.55	.55	.55	6,17		
L	6	250	M 10 x 1	14,9	18,5	26	11,5	21	10	6	14	14	14	3,10	FI-RSWND-06LM-WD-B-W3
	.24	3625		.59	.73	1.02	.45	.83	.39	.24	.55	.55	.55	6,83	
	8	250	M 12 x 1,5	17,8	20	28	13	25	12	9	17	17	17	5,20	
	.31	3625		.70	.79	1.10	.51	.98	.47	.35	.67	.67	.67	11,44	
	10	250	M 14 x 1,5	19,9	22	30	15	27	13	9	19	19	19	7,31	FI-RSWND-10LM-WD-B-W3
	.39	3625		.78	.87	1.18	.59	1.06	.51	.35	.75	.75	.75	16,07	
	12	250	M 16 x 1,5	22,8	23	31	16	32	15	9	22	22	22	10,27	
	.47	3625		.90	.91	1.22	.63	1.26	.59	.35	.87	.87	.87	22,59	
	12	250	M 18 x 1,5	24,9	25	33	18	37	19	9	24	24	24	12,66	FI-RSWND-12LM18x1,5-WD-B-W3
	.47	3625		.98	.98	1.30	.71	1.46	.75	.35	.94	.94	.87	27,91	
	15	250	M 18 x 1,5	24,9	25	33	18	37	18	9	24	24	27	13,86	
	.59	3625		.98	.98	1.30	.71	1.46	.71	.35	.94	.94	1.06	30,49	
	18	250	M 22 x 1,5	27,9	27	36	19,5	44,5	21,5	11	30	27	32	22,65	FI-RSWND-18LM-WD-B-W3
	.71	3625		1.10	1.06	1.42	.77	1.75	.85	.43	1.18	1.06	1.26	49,84	
	22	160	M 26 x 1,5	32,5	32	41	24,5	49	24	13	36	32	36	30,84	
.87	2320		1.28	1.26	1.61	.96	1.93	.94	.51	1.42	1.26	1.42	67,85		
S	6	250	M 12 x 1,5	17,8	21,5	29	14,5	25	12	9	17	17	17	5,57	FI-RSWND-06SM-WD-B-W3
	.24	3625		.70	.85	1.14	.57	.98	.47	.35	.67	.67	.67	12,25	
	8	250	M 14 x 1,5	19,9	23	31	16	27	13	9	19	19	19	7,82	
	.31	3625		.78	.91	1.22	.63	1.06	.51	.35	.75	.75	.75	17,21	
	10	250	M 16 x 1,5	22,8	23,5	32,5	16	32	15	9	22	22	22	10,71	FI-RSWND-10SM-WD-B-W3
	.39	3625		.90	.93	1.28	.63	1.26	.59	.35	.87	.87	.87	23,56	
	12	250	M 18 x 1,5	24,9	25	34	17,5	37	18	9	24	24	24	14,12	
	.47	3625		.98	.98	1.34	.69	1.46	.71	.35	.94	.94	.94	31,07	
	16	160	M 22 x 1,5	27,9	30	40	21,5	44,5	21,5	11	30	27	30	23,66	FI-RSWND-16SM-WD-B-W3
	.63	2320		1.10	1.18	1.57	.85	1.75	.85	.43	1.18	1.06	1.18	52,05	
20	160	M 27 x 2	32,9	34	45	23,5	49	24	13	36	32	36	33,01	FI-RSWND-20SM-WD-B-W3	
.79	2320		1.30	1.34	1.77	.93	1.93	.94	.51	1.42	1.26	1.42	72,62		

<sup>1</sup> Approximate dimension in assembled condition.

<sup>2</sup> Weight excluding cutting ring and union nut.

<sup>3</sup> Standard scope of delivery: Fitting body only.

Standard seal material is NBR (Buna-N®).

Port acc. to DIN 3852-1 (Form X) / ISO 9974-1

Male threaded studs were designed for female threaded ports in components made of steel. For applications with components made of softer mating materials (e.g. Aluminium), the use of connectors with additionally rolled male threads is recommended.

Please contact STAUFF prior to the assembly for further information.

**Ordering Codes**
**\*FI-RSWND\*-10\*L\*M\*-WD\*-B\*-W3\*-MS**

 \* Banjo Elbow (Medium-Pressure Version) **FI-RSWND**

 \* Outside Tube Diameter D1 (in mm) **-10**

 \* Series Extra-Light Series **LL**  
 Light Series **L**  
 Heavy Series **S**

 \* Thread Type Metric Parallel Thread **M**

If required, please indicate special sizes, e.g. M12x1.5!

 \* Seal Type Retaining Ring with Captive Seal **-WD**

 \* Seal Material NBR (Buna-N®) **-B**  
 FKM (Viton®) **-V**  
 EPDM **-E**

 \* Material Code Steel, zinc/nickel-plated **-W3**

Please contact STAUFF for alternative materials and surface finishings.

 \* Assembling / Kitting Fitting body only **—**

 Fitting body supplied with cutting ring and union nut **-MS**

 Fitting body supplied with soft-sealing cutting ring and union nut **-MSV**
**Connecting Parts**

	Cutting Ring Type <b>FI-DS</b>	Page 28
	Soft-Sealing Cutting Ring Type <b>FI-WDDS</b>	Page 29
	Support Sleeve Type <b>FI-VH</b>	Page 31
	STAUFF Form EVO Sealing Ring Type <b>FI-FD</b>	Page 32
	Union Nut Type <b>FI-M</b>	Page 33
	37° Flared Tube Fitting Set Type <b>FI-AB</b>	Page 37

**Spare Parts / Accessories**

	Retaining Ring with Captive Seal Type <b>FI-DIR</b>	Page 245
	O-Ring Type <b>O-RING</b>	Page 239



### Banjo Elbow (High-Pressure Version) Type FI-RSW-...-R-DK • Series L / S

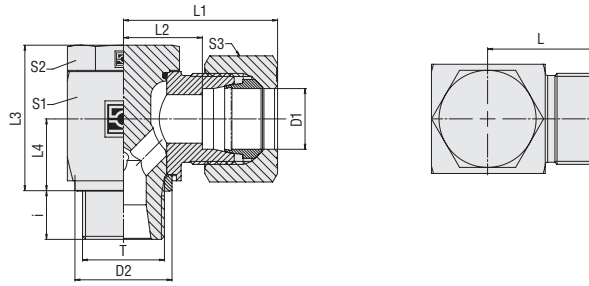

#### Ordering Codes

**\*FI-RSW\*-10\*L\*R\*-DK\*-B\*-W3\*-MS**

\* Banjo Elbow (High-Pressure Version)

**FI-RSW**

\* Outside Tube Diameter D1 (in mm)

**-10**

\* Series

Light Series  
Heavy Series

**L**  
**S**

\* Thread Type

Whitworth Parallel  
Pipe Thread (BSPP)

**R**

If required, please indicate special sizes, e.g. R1/8!

\* Seal Type

External Metallic Sealing Ring

**-DK**

\* Seal Material

NBR (Buna-N®)  
FKM (Viton®)  
EPDM

**-B**  
**-V**  
**-E**

\* Material Code

Steel, zinc/nickel-plated

**-W3**

Please contact STAUFF for alternative materials and surface finishings.

\* Assembling / Kitting Fitting body only

**—**

Fitting body supplied with cutting ring and union nut

**-MS**

Fitting body supplied with soft-sealing cutting ring and union nut

**-MSV**

#### Whitworth Parallel Pipe Thread (BSPP)

#### External Metallic Sealing Ring

Series	Tube OD	PB	Dimensions												Weight (%/lbs) ca. per 100	Ordering Codes <sup>3</sup>
	(mm/in) D1	(mm/psi) D1	Thread	T	D2	L	L1 <sup>1</sup>	L2	L3	L4	i	S1	S2	S3		
L	6	500	G 1/8	13	20	28	13	21	10,5	8	14	14	14	3,61	FI-RSW-06LR-DK-B-W3	
	.24	7250		.51	.79	1.10	.51	.83	.41	.31	.55	.55	.55	7.94		
	6	500	G 1/4	17,7	22	30,5	15	27,5	13,3	10	19	19	14	7,86	FI-RSW-06LR1/4-DK-B-W3	
	.24	7250		.7	.87	1.20	.59	1.08	.52	.39	.75	.75	.55	17.33		
	8	500	G 1/4	17,8	21	29	14	27	13,5	10	19	19	17	7,93	FI-RSW-08LR-DK-B-W3	
	.31	7250		.70	.83	1.14	.55	1.06	.53	.39	.75	.75	.67	17.44		
	10	500	G 1/4	17,8	22	30	15	27	13,5	10	19	19	19	8,15	FI-RSW-10LR-DK-B-W3	
	.39	7250		.70	.87	1.18	.59	1.06	.53	.39	.75	.75	.75	17.93		
	12	400	G 1/4	17,7	22	35	15	30,5	15,3	10	27	22	19	9,92	FI-RSW-12LR1/4-DK-B-W3	
	.47	5800		.7	.87	1.38	.59	1.20	.6	.39	1.06	.87	.75	21.87		
	12	400	G 3/8	22	24,5	32,5	17,5	32,5	16	12	24	22	22	13,75	FI-RSW-12LR-DK-B-W3	
	.47	5800		.87	.96	1.28	.69	1.28	.63	.47	.94	.87	.87	30.24		
	15	400	G 1/2	26	27	35	21	43	19,5	14	30	27	27	25,80	FI-RSW-15LR-DK-B-W3	
	.59	5800		1.02	1.06	1.38	.83	1.69	.77	.55	1.18	1.06	1.06	56.76		
	18	400	G 1/2	26	28	37	20,5	43	21,5	12	30	27	32	26,56	FI-RSW-18LR-DK-B-W3	
	.71	5800		1.02	1.10	1.46	.81	1.69	.85	.47	1.18	1.06	1.26	58.44		
	22	250	G 3/4	32	34,5	43,5	27	48	24	16	36	32	36	43,25	FI-RSW-22LR-DK-B-W3	
	.87	3625		1.26	1.36	1.71	1.06	1.89	.94	.63	1.42	1.26	1.42	95.14		
28	250	G 1	39	39	48	31,5	59	30,5	18	46	41	41	83,60	FI-RSW-28LR-DK-B-W3		
1.10	3625		1.54	1.54	1.89	1.24	2.32	1.20	.71	1.81	1.61	1.61	183.92			
35	250	G 1 1/4	49	46	57	35,5	70	35,5	20	55	50	50	140,80	FI-RSW-35LR-DK-B-W3		
1.38	3625		1.93	1.81	2.24	1.40	2.76	1.40	.79	2.17	1.97	1.97	309.76			
42	250	G 1 1/2	55	51	63	40	80	40,5	22	65	55	60	211,80	FI-RSW-42LR-DK-B-W3		
1.65	3625		2.17	2.01	2.48	1.57	3.15	1.59	.87	2.56	2.17	2.36	465.96			
S	6	500	G 1/4	17,8	23	31	16	27	13,5	10	19	19	17	8,36	FI-RSW-06SR-DK-B-W3	
	.24	7250		.70	.91	1.22	.63	1.06	.53	.39	.75	.75	.67	18.39		
	8	500	G 1/4	17,8	23	31	16	27	13,5	10	19	19	19	8,62	FI-RSW-08SR-DK-B-W3	
	.31	7250		.70	.91	1.22	.63	1.06	.53	.39	.75	.75	.75	18.96		
	10	500	G 3/8	22	25,5	34,5	18	32,5	16	10	24	22	22	14,57	FI-RSW-10SR-DK-B-W3	
	.39	7250		.87	1.00	1.36	.71	1.28	.63	.39	.94	.87	.87	32.06		
	12	400	G 3/8	22	27	36	18	32,5	16	10	24	22	24	14,59	FI-RSW-12SR-DK-B-W3	
	.47	5800		.87	1.06	1.42	.71	1.28	.63	.39	.94	.87	.94	32.09		
	14	400	G 1/2	26	30	40	22	41	19,5	14	30	27	27	26,55	FI-RSW-14SR-DK-B-W3	
	.55	5800		1.02	1.18	1.57	.87	1.61	.77	.55	1.18	1.06	1.06	58.41		
	16	400	G 1/2	26	30	40	21,5	43	21,5	12	30	27	30	26,86	FI-RSW-16SR-DK-B-W3	
	.63	5800		1.02	1.18	1.57	.85	1.69	.85	.47	1.18	1.06	1.18	59.10		
	20	315	G 3/4	32	36,5	47,5	26	48	24	16	36	32	36	44,88	FI-RSW-20SR-DK-B-W3	
	.79	4568		1.26	1.44	1.87	1.02	1.89	.94	.63	1.42	1.26	1.42	98.74		
	25	250	G 1	39	43	55	31	59	30,5	18	46	41	46	87,00	FI-RSW-25SR-DK-B-W3	
	.98	3625		1.54	1.69	2.17	1.22	2.32	1.20	.71	1.81	1.61	1.81	191.40		
	30	250	G 1 1/4	49	50	63	36,5	70	35,5	20	55	50	50	145,00	FI-RSW-30SR-DK-B-W3	
	1.18	3625		1.93	1.97	2.48	1.44	2.76	1.40	.79	2.17	1.97	1.97	319.00		
38	250	G 1 1/2	55	57	72	41	80	40,5	22	65	55	60	223,40	FI-RSW-38SR-DK-B-W3		
1.50	3625		2.17	2.24	2.83	1.61	3.15	1.59	.87	2.56	2.17	2.36	491.48			

<sup>1</sup> Approximate dimension in assembled condition.

<sup>2</sup> Weight excluding cutting ring and union nut.

<sup>3</sup> Standard scope of delivery: Fitting body only.

Port acc. to DIN 3852-2 (Form X) / ISO 1179-1

Male threaded studs were designed for female threaded ports in components made of steel. For applications with components made of softer mating materials (e.g. Aluminium), the use of connectors with additionally rolled male threads is recommended.

Please contact STAUFF prior to the assembly for further information.

Standard seal material is NBR (Buna-N®).



For use with aggressive media and/or at elevated temperatures, please remove the o-ring from the groove located on the banjo bolt prior to installation.

#### Connecting Parts



Cutting Ring  
Type FI-DS

Page 28



Soft-Sealing Cutting Ring  
Type FI-WDDS

Page 29



Support Sleeve  
Type FI-VH

Page 31



STAUFF Form EVO Sealing Ring  
Type FI-FD

Page 32



Union Nut  
Type FI-M

Page 33



37° Flared Tube Fitting Set  
Type FI-AB

Page 37

#### Spare Parts / Accessories



External Metallic Sealing Ring  
Type FI-DKR

Page 245



O-Ring  
Type O-RING

Page 239

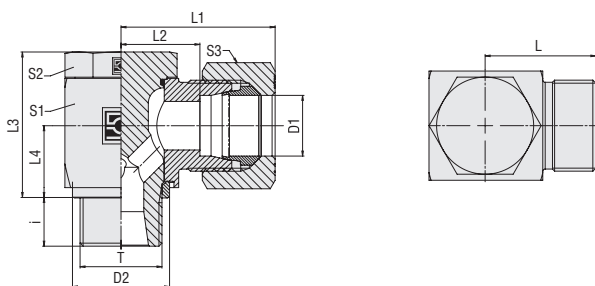

**Banjo Elbow (High-Pressure Version)  
Type FI-RSW-...-M-DK ■ Series L / S**

## External Metallic Sealing Ring

## Metric Parallel Thread

Series	Tube OD (mm/in)	PB (bar/psi)	Dimensions (mm/in)	Dimensions												Weight (kg/lbs) ca. per 100	Ordering Codes <sup>3</sup>
				Thread	D2	L	L <sup>1</sup>	L2	L3	L4	i	S1	S2	S3			
L	6	500	M10x1	13	20	28	13	21	10	8	14	14	14	3,66	FI-RSW-06LM-DK-B-W3		
	.24	7250		.51	.79	1.10	.51	.83	.39	.31	.55	.55	.55	8.05			
	8	500	M12x1.5	17,8	21	29	14	27	13,5	10	19	19	17	7,70	FI-RSW-08LM-DK-B-W3		
	.31	7250		.70	.83	1.14	.55	1.06	.53	.39	.75	.75	.67	16.94			
	10	500	M14x1.5	17,8	22	30	15	27	13,5	10	19	19	19	8,21	FI-RSW-10LM-DK-B-W3		
	.39	7250		.70	.87	1.18	.59	1.06	.53	.39	.75	.75	.75	18.06			
	12	400	M16x1.5	21	24,5	32,5	17,5	32,5	16	10	24	22	22	13,72	FI-RSW-12LM-DK-B-W3		
	.47	5800		.83	.96	1.28	.69	1.28	.63	.39	.94	.87	.87	30.19			
	12	315	M18x1.5	17,7	22	35	15	30,5	15,3	10	27	22	19	18,48	FI-RSW-12LM18x1.5-DK-B-W3		
	.47	4568		.7	.87	1.38	.59	1.20	.6	.39	1.06	.87	.75	40.74			
	15	400	M18x1,5	23	27	35	20	37	18,5	10	27	24	27	17,73	FI-RSW-15LM-DK-B-W3		
	.59	5800		.91	1.06	1.38	.79	1.46	.73	.39	1.06	.94	1.06	39.00			
	18	400	M22x1.5	27	28	37	20,5	43	21,5	12	30	27	32	27,01	FI-RSW-18LM-DK-B-W3		
	.71	5800		1.06	1.10	1.46	.81	1.69	.85	.47	1.18	1.06	1.26	59.41			
	22	250	M26x1.5	31	34,5	43,5	27	48	24	16	36	32	36	42,27	FI-RSW-22LM-DK-B-W3		
	.87	3625		1.22	1.36	1.71	1.06	1.89	.94	.63	1.42	1.26	1.42	93.00			
	28	250	M33x2	39	39	48	31,5	59	30,5	18	46	41	41	83,30	FI-RSW-28LM-DK-B-W3		
	1.10	3625		1.54	1.54	1.89	1.24	2.32	1.20	.71	1.81	1.61	1.61	183.26			
	35	250	M42x2	49	46	57	35,5	70	35,5	20	55	50	50	146,51	FI-RSW-35LM-DK-B-W3		
	1.38	3625		1.93	1.81	2.24	1.40	2.76	1.40	.79	2.17	1.97	1.97	322.31			
	42	250	M48x2	55	51	63	40	80	40,5	22	65	55	60	226,97	FI-RSW-42LM-DK-B-W3		
	1.65	3625		2.17	2.01	2.48	1.57	3.15	1.59	.87	2.56	2.17	2.36	499.34			
S	6	500	M12x1.5	17,8	23	31	16	27	13,5	10	19	19	17	10,09	FI-RSW-06SM-DK-B-W3		
	.24	7250		.70	.91	1.22	.63	1.06	.53	.39	.75	.75	.67	22.20			
	8	500	M14x1.5	17,8	23	31	16	27	13,5	10	19	19	19	8,69	FI-RSW-08SM-DK-B-W3		
	.31	7250		.70	.91	1.22	.63	1.06	.53	.39	.75	.75	.75	19.12			
	10	500	M16x1.5	21	25,5	34,5	18	32,5	16	10	24	22	22	14,46	FI-RSW-10SM-DK-B-W3		
	.39	7250		.83	1.00	1.36	.71	1.28	.63	.39	.94	.87	.87	31.81			
	12	400	M18x1.5	23	27	36	19,5	37	18,5	10	27	24	24	19,33	FI-RSW-12SM-DK-B-W3		
	.47	5800		.91	1.06	1.42	.77	1.46	.73	.39	1.06	.94	.94	42.52			
	14	400	M20x1.5	25	30	40	22	41	19,5	12	30	27	27	28,76	FI-RSW-14SM-DK-B-W3		
	.55	5800		.98	1.18	1.57	.87	1.61	.77	.47	1.18	1.06	1.06	63.27			
	16	400	M22x1.5	27	30	40	21,5	43	21,5	12	30	27	30	27,40	FI-RSW-16SM-DK-B-W3		
	.63	5800		1.06	1.18	1.57	.85	1.69	.85	.47	1.18	1.06	1.18	60.28			
	20	315	M27x2	32	36,5	47,5	26	48	24	16	36	32	36	45,17	FI-RSW-20SM-DK-B-W3		
	.79	4568		1.26	1.44	1.87	1.02	1.89	.94	.63	1.42	1.26	1.42	99.58			
	25	250	M33x2	39	43	55	31	59	30,5	18	46	41	46	30,63	FI-RSW-25SM-DK-B-W3		
	.98	3625		1.54	1.69	2.17	1.22	2.32	1.20	.71	1.81	1.61	1.81	67.39			
	30	250	M42x2	49	50	63	36,5	70	35,5	20	55	50	50	149,83	FI-RSW-30SM-DK-B-W3		
	1.18	3625		1.93	1.97	2.48	1.44	2.76	1.40	.79	2.17	1.97	1.97	329.62			
38	250	M48x2	55	57	72	41	80	40,5	22	65	55	60	236,07	FI-RSW-38SM-DK-B-W3			
1.50	3625		2.17	2.24	2.83	1.61	3.15	1.59	.87	2.56	2.17	2.36	519.36				

<sup>1</sup> Approximate dimension in assembled condition.

<sup>2</sup> Weight excluding cutting ring and union nut.

<sup>3</sup> Standard scope of delivery: Fitting body only.

Standard seal material is NBR (Buna-N®).



For use with aggressive media and/or at elevated temperatures, please remove the O-ring from the groove located on the Banjo bolt prior to installation.

Port acc. to DIN 3852-1 (Form X) / ISO 9974-1

Male threaded studs were designed for female threaded ports in components made of steel. For applications with components made of softer mating materials (e.g. Aluminium), the use of connectors with additionally rolled male threads is recommended.

Please contact STAUFF prior to the assembly for further information.

**Ordering Codes**

**\*FI-RSW\*-10\*L\*M\*-DK\*-B\*-W3\*-MS**

\* Banjo Elbow (High-Pressure Version) **FI-RSW**

\* Outside Tube Diameter D1 (in mm) **-10**

\* Series **L**  
Light Series  
**S**  
Heavy Series

\* Thread Type **M**  
Metric Parallel Thread

If required, please indicate special sizes, e.g. M12x1.5!

\* Seal Type **-DK**  
External Metallic Sealing Ring

\* Seal Material **-B**  
NBR (Buna-N®)  
**-V**  
FKM (Viton®)  
**-E**  
EPDM

\* Material Code **-W3**  
Steel, zinc/nickel-plated

Please contact STAUFF for alternative materials and surface finishings.

\* Assembling / Kitting **—**  
Fitting body only

**-MS**  
Fitting body supplied with cutting ring and union nut

**-MSV**  
Fitting body supplied with soft-sealing cutting ring and union nut

**Connecting Parts**

 Cutting Ring  
Type **FI-DS** Page 28

 Soft-Sealing Cutting Ring  
Type **FI-WDDS** Page 29

 Support Sleeve  
Type **FI-VH** Page 31

 STAUFF Form EVO Sealing Ring  
Type **FI-FD** Page 32

 Union Nut  
Type **FI-M** Page 33

 37° Flared Tube Fitting Set  
Type **FI-AB** Page 37

**Spare Parts / Accessories**

 External Metallic Sealing Ring  
Type **FI-DKR** Page 245

 O-Ring  
Type **O-RING** Page 239



### Banjo Elbow (High-Pressure Version) Type FI-RSW-...-R-WD ■ Series L / S

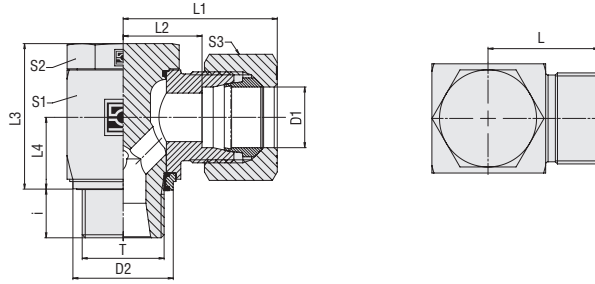

Whitworth Parallel Pipe Thread (BSPP)

Retaining Ring with Captive Seal



#### Ordering Codes

- \*FI-RSW\*-10\*L\*R\*-WD\*-B\*-W3\*-MS
- \* Banjo Elbow (High-Pressure Version) **FI-RSW**
- \* Outside Tube Diameter D1 (in mm) **-10**
- \* Series **L**  
Light Series  
**S**Heavy Series
- \* Thread Type **R**  
Whitworth Parallel  
Pipe Thread (BSPP)
- If required, please indicate special sizes, e.g. R1/8!
- \* Seal Type **-WD**  
Retaining Ring with Captive Seal
- \* Seal Material **-B**  
NBR (Buna-N®)  
**-V**FKM (Viton®)  
**-E**EPDM
- \* Material Code **-W3**  
Steel, zinc/nickel-plated
- Please contact STAUFF for alternative materials and surface finishings.
- \* Assembling / Kitting **—**  
Fitting body only  
**-MS** Fitting body supplied with cutting ring and union nut  
**-MSV** Fitting body supplied with soft-sealing cutting ring and union nut

#### Connecting Parts

-  Cutting Ring  
Type **FI-DS** Page 28
-  Soft-Sealing Cutting Ring  
Type **FI-WDDS** Page 29
-  Support Sleeve  
Type **FI-VH** Page 31
-  STAUFF Form EVO Sealing Ring  
Type **FI-FD** Page 32
-  Union Nut  
Type **FI-M** Page 33
-  37° Flared Tube Fitting Set  
Type **FI-AB** Page 37

#### Spare Parts / Accessories

-  Retaining Ring with Captive Seal  
Type **FI-DIR** Page 245
-  O-Ring  
Type **O-RING** Page 239

Series	Tube OD (mm/in)	PB (mm/PSI)	Dimensions										Weight (kg/lbs) ca. per 100	Ordering Codes <sup>3</sup>	
			Thread	T	D2	L	L1 <sup>1</sup>	L2	L3	L4	i	S1			S2
L	6	500	G 1/8	14,9	20	28	13	21	10,5	8	14	14	14	3,65	FI-RSW-06LR-WD-B-W3
	.24	7250		.59	.79	1.10	.51	.83	.41	.31	.55	.55	.55	8,04	
	6	500	G 1/4	18,8	22	28	15	27,7	13,5	9,8	19	19	14	7,88	FI-RSW-06LR1/4-WD-B-W3
	.24	7250		.74	.87	1.10	.59	1.09	.53	.39	.75	.75	.55	17,37	
	8	500	G 1/4	18,8	21	29	14	27	13,5	10	19	19	17	7,92	FI-RSW-08LR-WD-B-W3
	.31	7250		.74	.83	1.14	.55	1.06	.53	.39	.75	.75	.67	17,43	
	10	500	G 1/4	18,8	22	30	15	27	13,5	10	19	19	19	8,16	FI-RSW-10LR-WD-B-W3
	.39	7250		.74	.87	1.18	.59	1.06	.53	.39	.75	.75	.75	17,95	
	12	400	G 1/4	18,8	22	31	15	30,7	15,5	9,8	22	19	22	10,06	FI-RSW-12LR1/4-WD-B-W3
	.47	5800		.74	.87	1.22	.59	1.21	.61	.39	.87	.75	.87	22,18	
	12	400	G 3/8	22,8	24,5	32,5	17,5	32,5	16	12	24	22	22	13,94	FI-RSW-12LR-WD-B-W3
	.47	5800		.90	.96	1.28	.69	1.28	.63	.47	.94	.87	.87	30,67	
	15	400	G 1/2	27,9	27	35	21	43	19,5	14	30	27	27	26,03	FI-RSW-15LR-WD-B-W3
	.59	5800		1.10	1.06	1.38	.83	1.69	.77	.55	1.18	1.06	1.06	57,26	
	18	400	G 1/2	27,9	28	37	20,5	43	21,5	12	30	27	32	26,75	FI-RSW-18LR-WD-B-W3
.71	5800		1.10	1.10	1.46	.81	1.69	.85	.47	1.18	1.06	1.26	58,86		
22	250	G 3/4	32,9	34,5	43,5	27	48	24	16	36	32	32	42,37	FI-RSW-22LR-WD-B-W3	
.87	3625		1.30	1.36	1.71	1.06	1.89	.94	.63	1.42	1.26	1.42	93,21		
28	250	G 1	40,9	39	48	31,5	59	30,5	18	46	41	41	84,00	FI-RSW-28LR-WD-B-W3	
1.10	3625		1.61	1.54	1.89	1.24	2.32	1.20	.71	1.81	1.61	1.61	184,80		
35	250	G 1 1/4	50,9	46	57	35,5	70	35,5	20	55	50	50	140,00	FI-RSW-35LR-WD-B-W3	
1.38	3625		2.00	1.81	2.24	1.40	2.76	1.40	.79	2.17	1.97	1.97	308,00		
42	250	G 1 1/2	55,9	51	63	40	80	40,5	22	65	55	60	214,30	FI-RSW-42LR-WD-B-W3	
1.65	3625		2.20	2.01	2.48	1.57	3.15	1.59	.87	2.56	2.17	2.36	471,46		
S	6	500	G 1/4	18,8	23	31	16	27	13,5	10	19	19	17	8,36	FI-RSW-06SR-WD-B-W3
	.24	7250		.74	.91	1.22	.63	1.06	.53	.39	.75	.75	.67	18,40	
	8	500	G 1/4	18,8	23	31	16	27	13,5	10	19	19	19	8,63	FI-RSW-08SR-WD-B-W3
	.31	7250		.74	.91	1.22	.63	1.06	.53	.39	.75	.75	.75	18,99	
	10	500	G 3/8	22,8	25,5	34,5	18	32,5	16	10	24	22	22	14,36	FI-RSW-10SR-WD-B-W3
	.39	7250		.90	1.00	1.36	.71	1.28	.63	.39	.94	.87	.87	31,60	
	12	400	G 3/8	22,8	27	36	18	32,5	16	10	24	22	24	14,86	FI-RSW-12SR-WD-B-W3
	.47	5800		.90	1.06	1.42	.71	1.28	.63	.39	.94	.87	.94	32,70	
	14	400	G 1/2	27,9	30	40	22	41	19,5	14	30	27	27	26,74	FI-RSW-14SR-WD-B-W3
	.55	5800		1.10	1.18	1.57	.87	1.61	.77	.55	1.18	1.06	1.06	58,83	
	16	400	G 1/2	27,9	30	40	21,5	43	21,5	12	30	27	30	27,23	FI-RSW-16SR-WD-B-W3
	.63	5800		1.10	1.18	1.57	.85	1.69	.85	.47	1.18	1.06	1.18	59,91	
	20	315	G 3/4	32,9	36,5	47,5	26	48	24	16	36	32	36	44,33	FI-RSW-20SR-WD-B-W3
	.79	4568		1.30	1.44	1.87	1.02	1.89	.94	.63	1.42	1.26	1.42	97,53	
	25	250	G 1	40,9	43	55	31	59	30,5	18	46	41	46	86,90	FI-RSW-25SR-WD-B-W3
.98	3625		1.61	1.69	2.17	1.22	2.32	1.20	.71	1.81	1.61	1.81	191,18		
30	250	G 1 1/4	50,9	50	63	36,5	70	35,5	20	55	50	50	144,70	FI-RSW-30SR-WD-B-W3	
1.18	3625		2.00	1.97	2.48	1.44	2.76	1.40	.79	2.17	1.97	1.97	318,34		
38	250	G 1 1/2	55,9	57	72	41	80	40,5	22	65	55	60	223,60	FI-RSW-38SR-WD-B-W3	
1.50	3625		2.20	2.24	2.83	1.61	3.15	1.59	.87	2.56	2.17	2.36	491,92		

<sup>1</sup> Approximate dimension in assembled condition.

<sup>2</sup> Weight excluding cutting ring and union nut.

<sup>3</sup> Standard scope of delivery: Fitting body only.

Standard seal material is NBR (Buna-N®).

Port acc. to DIN 3852-2 (Form X) / ISO 1179-1

Male threaded studs were designed for female threaded ports in components made of steel. For applications with components made of softer mating materials (e.g. Aluminium), the use of connectors with additionally rolled male threads is recommended.

Please contact STAUFF prior to the assembly for further information.



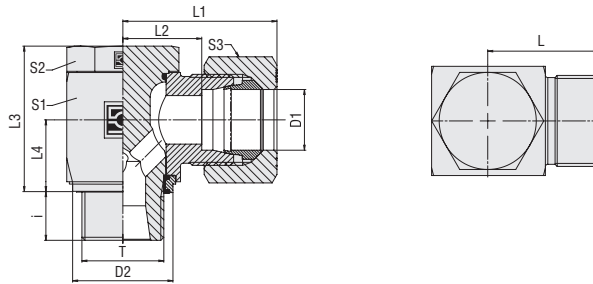

**Banjo Elbow (High-Pressure Version)  
Type FI-RSW-...-M-WD ■ Series L / S**



**Retaining Ring with Captive Seal**

**Metric Parallel Thread**

Series	Tube OD (mm/in)	PB (bar/psi)	Dimensions (mm/in)	Weight (kg/lbs) ca. per 100	Ordering Codes <sup>3</sup>
L	D1	Thread T	D2 L L1 <sup>1</sup> L2 L3 L4 i S1 S2 S3		
L	6	500	M10x1 14,9 20 28 13 21 10 8 14 14 14 3,68	3,68	FI-RSW-06LM-WD-B-W3
	.24	7250	.59 .79 1.10 .51 .83 .39 .31 .55 .55 .55 8.09	8.09	
	8	500	M12x1,5 17,8 21 29 14 27 13,5 10 19 19 17 7,68	7,68	FI-RSW-08LM-WD-B-W3
	.31	7250	.70 .83 1.14 .55 1.06 .53 .39 .75 .75 .67 16.90	16.90	
	10	500	M14x1,5 19,9 22 30 15 27 13,5 10 19 19 19 8,28	8,28	FI-RSW-10LM-WD-B-W3
	.39	7250	.78 .87 1.18 .59 1.06 .53 .39 .75 .75 .75 18.22	18.22	
	12	400	M16x1,5 22,8 24,5 32,5 17,5 32,5 16 10 24 22 22 13,60	13,60	FI-RSW-12LM-WD-B-W3
	.47	5800	.90 .96 1.28 .69 1.28 .63 .39 .94 .87 .87 29.92	29.92	
	12	400	M18x1,5 24,5 26 32,5 19 37,8 13,6 14,7 27 24 22 18,73	18,73	FI-RSW-12LM18x1,5-WD-B-W3
	.47	5800	.96 1.02 1.28 .75 1.49 .54 .58 1.06 .94 .87 41.29	41.29	
	15	400	M18x1,5 24,9 27 35 20 37 18,5 10 27 24 27 19,21	19,21	FI-RSW-15LM-WD-B-W3
	.59	5800	.98 1.06 1.38 .79 1.46 .73 .39 1.06 .94 1.06 42.26	42.26	
	18	400	M22x1,5 27,9 28 37 20,5 43 21,5 12 30 27 32 27,12	27,12	FI-RSW-18LM-WD-B-W3
	.71	5800	1.10 1.10 1.46 .81 1.69 .85 .47 1.18 1.06 1.26 59.67	59.67	
	22	250	M26x1,5 32,5 34,5 43,5 27 48 24 16 36 32 36 42,64	42,64	FI-RSW-22LM-WD-B-W3
	.87	3625	1.28 1.36 1.71 1.06 1.89 .94 .63 1.42 1.26 1.42 93.82	93.82	
28	250	M33x2 40,9 39 48 31,5 59 30,5 18 46 41 41 95,43	95,43	FI-RSW-28LM-WD-B-W3	
1.10	3625	1.61 1.54 1.89 1.24 2.32 1.20 .71 1.81 1.61 1.61 209.95	209.95		
35	250	M42x2 50,9 46 57 35,5 70 35,5 20 55 50 50 146,83	146,83	FI-RSW-35LM-WD-B-W3	
1.38	3625	2.0 1.81 2.24 1.40 2.76 1.40 .79 2.17 1.97 1.97 323.03	323.03		
42	250	M48x2 55,9 51 63 40 80 40,5 22 65 55 60 221,72	221,72	FI-RSW-42LM-WD-B-W3	
1.65	3625	2.20 2.01 2.48 1.57 3.15 1.59 .87 2.56 2.17 2.36 487.79	487.79		
S	6	500	M12x1,5 17,8 23 31 16 27 13,5 10 19 19 17 8,10	8,10	FI-RSW-06SM-WD-B-W3
	.24	7250	.70 .91 1.22 .63 1.06 .53 .39 .75 .75 .67 17.82	17.82	
	8	500	M14x1,5 19,9 23 31 16 27 13,5 10 19 19 19 8,80	8,80	FI-RSW-08SM-WD-B-W3
	.31	7250	.78 .91 1.22 .63 1.06 .53 .39 .75 .75 .75 19.36	19.36	
	10	500	M16x1,5 22,8 25,5 34,5 18 32,5 16 10 24 22 22 14,19	14,19	FI-RSW-10SM-WD-B-W3
	.39	7250	.90 1.00 1.36 .71 1.28 .63 .39 .94 .87 .87 31.21	31.21	
	12	400	M18x1,5 24,9 27 36 19,5 37 18,5 10 27 24 24 19,53	19,53	FI-RSW-12SM-WD-B-W3
	.47	5800	.98 1.06 1.42 .77 1.46 .73 .39 1.06 .94 .94 42.97	42.97	
	14	400	M20x1,5 27,5 30 40 22 41 19,5 12 30 27 27 29,38	29,38	FI-RSW-14SM-WD-B-W3
	.55	5800	1.08 1.18 1.57 .87 1.61 .77 .47 1.18 1.06 1.06 64.63	64.63	
	16	400	M22x1,5 27,9 30 40 21,5 43 21,5 12 30 27 30 27,53	27,53	FI-RSW-16SM-WD-B-W3
	.63	5800	1.10 1.18 1.57 .85 1.69 .85 .47 1.18 1.06 1.18 60.56	60.56	
	20	315	M27x2 32,9 36,5 47,5 26 48 24 16 36 32 36 44,30	44,30	FI-RSW-20SM-WD-B-W3
	.79	4568	1.30 1.44 1.87 1.02 1.89 .94 .63 1.42 1.26 1.42 97.47	97.47	
	25	250	M33x2 40,9 43 55 31 59 30,5 18 46 41 46 224,50	224,50	FI-RSW-25SM-WD-B-W3
	.98	3625	1.61 1.69 2.17 1.22 2.32 1.20 .71 1.81 1.61 1.81 493.90	493.90	
30	250	M42x2 50,9 50 63 36,5 70 35,5 20 55 50 50 150,16	150,16	FI-RSW-30SM-WD-B-W3	
1.18	3625	2.00 1.97 2.48 1.44 2.76 1.40 .79 2.17 1.97 1.97 330.36	330.36		
38	250	M48x2 55,9 57 72 41 80 40,5 22 65 55 60 224,90	224,90	FI-RSW-38SM-WD-B-W3	
1.50	3625	2.20 2.24 2.83 1.61 3.15 1.59 .87 2.56 2.17 2.36 494.78	494.78		

<sup>1</sup> Approximate dimension in assembled condition.

<sup>2</sup> Weight excluding cutting ring and union nut.

<sup>3</sup> Standard scope of delivery: Fitting body only.

Standard seal material is NBR (Buna-N®).

Port acc. to DIN 3852-1 (Form X) / ISO 9974-1

Male threaded studs were designed for female threaded ports in components made of steel. For applications with components made of softer mating materials (e.g. Aluminium), the use of connectors with additionally rolled male threads is recommended.

Please contact STAUFF prior to the assembly for further information.

**Ordering Codes**

**\*FI-RSW\*-10\*L\*M\*-WD\*-B\*-W3\*-MS**

\* Banjo Elbow (High-Pressure Version) **FI-RSW**

\* Outside Tube Diameter D1 (in mm) **-10**

\* Series Light Series **L**  
Heavy Series **S**

\* Thread Type Metric Parallel Thread **M**

If required, please indicate special sizes, e.g. M12x1.5!

\* Seal Type Retaining Ring with Captive Seal **-WD**

\* Seal Material NBR (Buna-N®) **-B**  
FKM (Viton®) **-V**  
EPDM **-E**

\* Material Code Steel, zinc/nickel-plated **-W3**

Please contact STAUFF for alternative materials and surface finishings.

\* Assembling / Kitting Fitting body only **—**

Fitting body supplied with cutting ring and union nut **-MS**

Fitting body supplied with soft-sealing cutting ring and union nut **-MSV**

**Connecting Parts**

Cutting Ring  
Type **FI-DS** Page 28

Soft-Sealing Cutting Ring  
Type **FI-WDDS** Page 29

Support Sleeve  
Type **FI-VH** Page 31

STAUFF Form EVO Sealing Ring  
Type **FI-FD** Page 32

Union Nut  
Type **FI-M** Page 33

37° Flared Tube Fitting Set  
Type **FI-AB** Page 37

**Spare Parts / Accessories**

Retaining Ring with Captive Seal  
Type **FI-DIR** Page 245

O-Ring  
Type **O-RING** Page 239



### Banjo Tee (High-Pressure Version) Type FI-RST-...-R-DK ▪ Series L / S

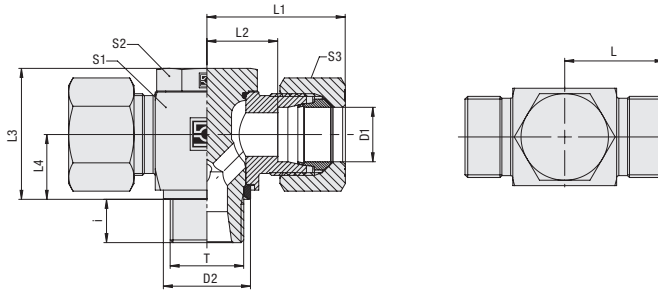

#### Whitworth Parallel Pipe Thread (BSPP)

#### External Metallic Sealing Ring

#### Ordering Codes

#### \*FI-RST\*-10\*L\*R\*-DK\*-B\*-W3\*-MS

- \* Banjo Tee (High-Pressure Version) **FI-RST**
- \* Outside Tube Diameter D1 (in mm) **-10**
- \* Series **L**  
Light Series  
**S**  
Heavy Series
- \* Thread Type **R**  
Whitworth Parallel  
Pipe Thread (BSPP)
- If required, please indicate special sizes, e.g. R1/8!
- \* Seal Type **-DK**  
External Metallic Sealing Ring
- \* Seal Material **-B**  
NBR (Buna-N®)  
**-V**  
FKM (Viton®)  
**-E**  
EPDM
- \* Material Code **-W3**  
Steel, zinc/nickel-plated
- Please contact STAUFF for alternative materials and surface finishings.
- \* Assembling / Kitting **—**  
Fitting body only  
**-MS**  
Fitting body supplied with cutting ring and union nut  
**-MSV**  
Fitting body supplied with soft-sealing cutting ring and union nut

Series	Tube OD (mm/in)	PB (mm/in)	Dimensions										Weight (kg/lbs) ca. per 100	Ordering Codes <sup>3</sup>	
			Thread	T	D2	L	L1 <sup>1</sup>	L2	L3	L4	i	S1			S2
L	6	500	G 1/8	13	20	28	13	21	10,5	8	14	14	14	4,57	FI-RST-06LR-DK-B-W3
	.24	7250		.51	.79	1.10	.51	.83	.41	.31	.55	.55	.55	10,04	
	8	500	G 1/4	17,8	21	29	14	27	13,5	10	19	19	17	8,60	FI-RST-08LR-DK-B-W3
	.31	7250		.70	.83	1.14	.55	1.06	.53	.39	.75	.75	.67	18,92	
	10	500	G 1/4	17,8	22	30	15	27	13,5	10	19	19	19	8,93	FI-RST-10LR-DK-B-W3
	.39	7250		.70	.87	1.18	.59	1.06	.53	.39	.75	.75	.75	19,65	
	12	400	G 3/8	22	24,5	32,5	17,5	32,5	16	12	24	22	22	15,04	FI-RST-12LR-DK-B-W3
	.47	5800		.87	.96	1.28	.69	1.28	.63	.47	.94	.87	.87	33,08	
	15	400	G 1/2	26	27	35	21	43	19,5	14	30	27	27	30,15	FI-RST-15LR-DK-B-W3
	.59	5800		1.02	1.06	1.38	.83	1.69	.77	.55	1.18	1.06	1.06	66,33	
	18	400	G 1/2	26	28	37	20,5	43	21,5	12	30	27	32	31,25	FI-RST-18LR-DK-B-W3
	.71	5800		1.02	1.10	1.46	.81	1.69	.85	.47	1.18	1.06	1.26	68,75	
	22	250	G 3/4	32	34,5	43,5	27	48	24	16	36	32	36	46,23	FI-RST-22LR-DK-B-W3
	.87	3625		1.26	1.36	1.71	1.06	1.89	.94	.63	1.42	1.26	1.42	101,70	
	28	250	G 1	39	39	48	31,5	59	30,5	18	46	41	41	80,19	FI-RST-28LR-DK-B-W3
	1.10	3625		1.54	1.54	1.89	1.24	2.32	1.20	.71	1.81	1.61	1.61	176,41	
	35	250	G 1 1/4	49	46	57	35,5	70	35,5	20	55	50	50	145,46	FI-RST-35LR-DK-B-W3
1.38	3625		1.93	1.81	2.24	1.40	2.76	1.40	.79	2.17	1.97	1.97	320,00		
42	250	G 1 1/2	55	51	63	40	80	40,5	22	65	55	60	217,14	FI-RST-42LR-DK-B-W3	
1.65	3625		2.17	2.01	2.48	1.57	3.15	1.59	.87	2.56	2.17	2.36	477,71		
S	6	500	G 1/4	17,8	23	31	16	27	13,5	10	19	19	17	9,48	FI-RST-06SR-DK-B-W3
	.24	7250		.70	.91	1.22	.63	1.06	.53	.39	.75	.75	.67	20,86	
	8	500	G 1/4	17,8	23	31	16	27	13,5	10	19	19	19	9,97	FI-RST-08SR-DK-B-W3
	.31	7250		.70	.91	1.22	.63	1.06	.53	.39	.75	.75	.75	21,93	
	10	500	G 3/8	22	25,5	34,5	18	32,5	16	10	24	22	22	19,10	FI-RST-10SR-DK-B-W3
	.39	7250		.87	1.00	1.36	.71	1.28	.63	.39	.94	.87	.87	42,02	
	12	400	G 3/8	22	27	36	18	32,5	16	10	24	22	24	16,38	FI-RST-12SR-DK-B-W3
	.47	5800		.87	1.06	1.42	.71	1.28	.63	.39	.94	.87	.94	36,03	
	14	400	G 1/2	26	30	40	22	41	19,5	14	30	27	27	91,00	FI-RST-14SR-DK-B-W3
	.55	5800		1.02	1.18	1.57	.87	1.61	.77	.55	1.18	1.06	1.06	200,20	
	16	400	G 1/2	26	30	40	21,5	43	21,5	12	30	27	30	31,85	FI-RST-16SR-DK-B-W3
	.63	5800		1.02	1.18	1.57	.85	1.69	.85	.47	1.18	1.06	1.18	70,08	
	20	315	G 3/4	32	36,5	47,5	26	48	24	16	36	32	36	48,45	FI-RST-20SR-DK-B-W3
	.79	4568		1.26	1.44	1.87	1.02	1.89	.94	.63	1.42	1.26	1.42	106,58	
	25	250	G 1	39	43	55	31	59	30,5	18	46	41	46	93,55	FI-RST-25SR-DK-B-W3
	.98	3625		1.54	1.69	2.17	1.22	2.32	1.20	.71	1.81	1.61	1.81	205,80	
	30	250	G 1 1/4	49	50	63	36,5	70	35,5	20	55	50	50	153,59	FI-RST-30SR-DK-B-W3
1.18	3625		1.93	1.97	2.48	1.44	2.76	1.40	.79	2.17	1.97	1.97	337,91		
38	250	G 1 1/2	55	57	72	41	80	40,5	22	65	55	60	236,22	FI-RST-38SR-DK-B-W3	
1.50	3625		2.17	2.24	2.83	1.61	3.15	1.59	.87	2.56	2.17	2.36	519,69		

#### Connecting Parts

- Cutting Ring  
Type **FI-DS** Page 28
- Soft-Sealing Cutting Ring  
Type **FI-WDDS** Page 29
- Support Sleeve  
Type **FI-VH** Page 31
- STAUFF Form EVO Sealing Ring  
Type **FI-FD** Page 32
- Union Nut  
Type **FI-M** Page 33
- 37° Flared Tube Fitting Set  
Type **FI-AB** Page 37

#### Spare Parts / Accessories

- External Metallic Sealing Ring  
Type **FI-DKR** Page 245
- O-Ring  
Type **O-RING** Page 239

<sup>1</sup> Approximate dimension in assembled condition.

<sup>2</sup> Weight excluding cutting ring and union nut.

<sup>3</sup> Standard scope of delivery: Fitting body only.

Standard seal material is NBR (Buna-N®).



For use with aggressive media and/or at elevated temperatures, please remove the o-ring from the groove located on the banjo bolt prior to installation.

Port acc. to DIN 3852-2 (Form X) / ISO 1179-1

Male threaded studs were designed for female threaded ports in components made of steel. For applications with components made of softer mating materials (e.g. Aluminium), the use of connectors with additionally rolled male threads is recommended.

Please contact STAUFF prior to the assembly for further information.

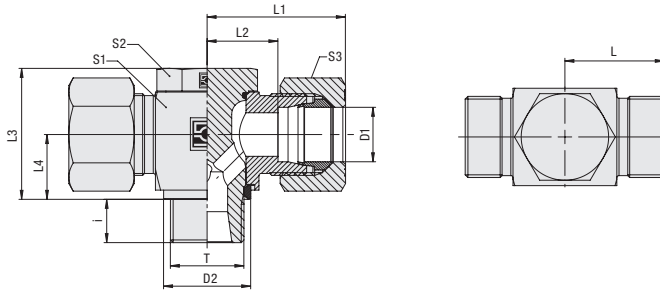

**Banjo Tee (High-Pressure Version)  
Type FI-RST-...-M-DK ■ Series L / S**

**External Metallic Sealing Ring**
**Metric Parallel Thread**

Series	Tube OD (mm/in)	PB (bar/psi)	Dimensions (mm/in)											Weight (%)/lbs ca. per 100	Ordering Codes <sup>3</sup>
			Thread	T	D2	L	L1 <sup>1</sup>	L2	L3	L4	i	S1	S2		
L	6	500	M10x1	13	20	28	13	21	10	8	14	14	14	4,59	FI-RST-06LM-DK-B-W3
	.24	7250		.51	.79	1.10	.51	.83	.39	.31	.55	.55	.55	10.10	
	8	500	M12x1,5	17,8	21	29	14	27	13,5	10	19	19	17	9,66	FI-RST-08LM-DK-B-W3
	.31	7250		.70	.83	1.14	.55	1.06	.53	.39	.75	.75	.67	21.25	
	10	500	M14x1,5	17,8	22	30	15	27	13,5	10	19	19	19	11,05	FI-RST-10LM-DK-B-W3
	.39	7250		.70	.87	1.18	.59	1.06	.53	.39	.75	.75	.75	24.30	
	12	400	M16x1,5	21	24,5	32,5	17,5	32,5	16	10	24	22	22	14,71	FI-RST-12LM-DK-B-W3
	.47	5800		.83	.96	1.28	.69	1.28	.63	.39	.94	.87	.87	32.35	
	15	400	M18x1,5	23	27	35	20	37	18,5	10	27	24	27	10,80	FI-RST-15LM-DK-B-W3
	.59	5800		.91	1.06	1.38	.79	1.46	.73	.39	1.06	.94	1.06	23.76	
	18	400	M22x1,5	27	28	37	20,5	43	21,5	12	30	27	32	31,81	FI-RST-18LM-DK-B-W3
	.71	5800		1.06	1.10	1.46	.81	1.69	.85	.47	1.18	1.06	1.26	69.97	
	22	250	M26x1,5	31	34,5	43,5	27	48	24	16	36	32	36	44,90	FI-RST-22LM-DK-B-W3
	.87	3625		1.22	1.36	1.71	1.06	1.89	.94	.63	1.42	1.26	1.42	98.78	
	28	250	M33x2	39	39	48	31,5	59	30,5	18	46	41	41	85,11	FI-RST-28LM-DK-B-W3
	1.10	3625		1.54	1.54	1.89	1.24	2.32	1.20	.71	1.81	1.61	1.61	187.23	
	35	250	M42x2	49	46	57	35,5	70	35,5	20	55	50	50	145,36	FI-RST-35LM-DK-B-W3
	1.38	3625		1.93	1.81	2.24	1.40	2.76	1.40	.79	2.17	1.97	1.97	319.78	
42	250	M48x2	55	51	63	40	80	40,5	22	65	55	60	218,24	FI-RST-42LM-DK-B-W3	
1.65	3625		2.17	2.01	2.48	1.57	3.15	1.59	.87	2.56	2.17	2.36	480.13		
S	6	500	M12x1,5	17,8	23	31	16	27	13,5	10	19	19	17	11,23	FI-RST-06SM-DK-B-W3
	.24	7250		.70	.91	1.22	.63	1.06	.53	.39	.75	.75	.67	24.71	
	8	500	M14x1,5	17,8	23	31	16	27	13,5	10	19	19	19	12,02	FI-RST-08SM-DK-B-W3
	.31	7250		.70	.91	1.22	.63	1.06	.53	.39	.75	.75	.75	26.45	
	10	500	M16x1,5	21	25,5	34,5	18	32,5	16	10	24	22	22	19,01	FI-RST-10SM-DK-B-W3
	.39	7250		.83	1.00	1.36	.71	1.28	.63	.39	.94	.87	.87	41.81	
	12	400	M18x1,5	23	27	36	19,5	37	18,5	10	27	24	24	21,32	FI-RST-12SM-DK-B-W3
	.47	5800		.91	1.06	1.42	.77	1.46	.73	.39	1.06	.94	.94	46.90	
	14	400	M20x1,5	25	30	40	22	41	19,5	12	30	27	27	30,96	FI-RST-14SM-DK-B-W3
	.55	5800		.98	1.18	1.57	.87	1.61	.77	.47	1.18	1.06	1.06	68.11	
	16	400	M22x1,5	27	30	40	21,5	43	21,5	12	30	27	30	32,41	FI-RST-16SM-DK-B-W3
	.63	5800		1.06	1.18	1.57	.85	1.69	.85	.47	1.18	1.06	1.18	71.29	
	20	315	M27x2	32	36,5	47,5	26	48	24	16	36	32	36	16,50	FI-RST-20SM-DK-B-W3
	.79	4568		1.26	1.44	1.87	1.02	1.89	.94	.63	1.42	1.26	1.42	36.29	
	25	250	M33x2	39	43	55	31	59	30,5	18	46	41	46	93,47	FI-RST-25SM-DK-B-W3
.98	3625		1.54	1.69	2.17	1.22	2.32	1.20	.71	1.81	1.61	1.81	205.62		
30	250	M42x2	49	50	63	36,5	70	35,5	20	55	50	50	153,16	FI-RST-30SM-DK-B-W3	
1.18	3625		1.93	1.97	2.48	1.44	2.76	1.40	.79	2.17	1.97	1.97	336.94		
38	250	M48x2	55	57	72	41	80	40,5	22	65	55	60	237,04	FI-RST-38SM-DK-B-W3	
1.50	3625		2.17	2.24	2.83	1.61	3.15	1.59	.87	2.56	2.17	2.36	521.49		

<sup>1</sup> Approximate dimension in assembled condition.

<sup>2</sup> Weight excluding cutting ring and union nut.

<sup>3</sup> Standard scope of delivery: Fitting body only.

Standard seal material is NBR (Buna-N®).



For use with aggressive media and/or at elevated temperatures, please remove the o-ring from the groove located on the banjo bolt prior to installation.

Port acc. to DIN 3852-1 (Form X) / ISO 9974-1

Male threaded studs were designed for female threaded ports in components made of steel. For applications with components made of softer mating materials (e.g. Aluminium), the use of connectors with additionally rolled male threads is recommended.

Please contact STAUFF prior to the assembly for further information.

**Ordering Codes**
**\*FI-RST\*-10\*L\*M\*-DK\*-B\*-W3\*-MS**

- \* Banjo Tee (High-Pressure Version) **FI-RST**
  - \* Outside Tube Diameter D1 (in mm) **-10**
  - \* Series Light Series **L**  
Heavy Series **S**
  - \* Thread Type Metric Parallel Thread **M**
- If required, please indicate special sizes, e.g. M12x1.5!
- \* Seal Type External Metallic Sealing Ring **-DK**
  - \* Seal Material NBR (Buna-N®) **-B**  
FKM (Viton®) **-V**  
EPDM **-E**
  - \* Material Code Steel, zinc/nickel-plated **-W3**

Please contact STAUFF for alternative materials and surface finishings.

- \* Assembling / Kitting Fitting body only **—**
- Fitting body supplied with cutting ring and union nut **-MS**
- Fitting body supplied with soft-sealing cutting ring and union nut **-MSV**

**Connecting Parts**

-  Cutting Ring  
Type **FI-DS** Page 28
-  Soft-Sealing Cutting Ring  
Type **FI-WDDS** Page 29
-  Support Sleeve  
Type **FI-VH** Page 31
-  STAUFF Form EVO Sealing Ring  
Type **FI-FD** Page 32
-  Union Nut  
Type **FI-M** Page 33
-  37° Flared Tube Fitting Set  
Type **FI-AB** Page 37

**Spare Parts / Accessories**

-  External Metallic Sealing Ring  
Type **FI-DKR** Page 245
-  O-Ring  
Type **O-RING** Page 239



**Banjo Tee (High-Pressure Version)**  
**Type FI-RST-...-R-WD • Series L / S**

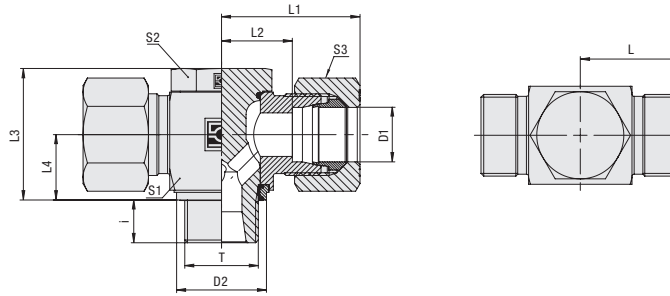

**Whitworth Parallel Pipe Thread (BSPP)**

**Retaining Ring with Captive Seal**

**Ordering Codes**

**\*FI-RST\*-10\*L\*R\*-WD\*-B\*-W3\*-MS**

- \* Banjo Tee (High-Pressure Version) **FI-RST**
- \* Outside Tube Diameter D1 (in mm) **-10**
- \* Series **L**  
Light Series  
**S**  
Heavy Series
- \* Thread Type **R**  
Whitworth Parallel  
Pipe Thread (BSPP)
- If required, please indicate special sizes, e.g. R1/8!
- \* Seal Type **-WD**  
Retaining Ring with Captive Seal
- \* Seal Material **-B**  
NBR (Buna-N®)  
**-V**  
FKM (Viton®)  
**-E**  
EPDM
- \* Material Code **-W3**  
Steel, zinc/nickel-plated
- Please contact STAUFF for alternative materials and surface finishings.
- \* Assembling / Kitting **—**  
Fitting body only  
**-MS**  
Fitting body supplied with cutting ring and union nut  
**-MSV**  
Fitting body supplied with soft-sealing cutting ring and union nut

Series	Tube OD (mm/in)	PB (mm/in)	Dimensions										Weight (kg/lbs) ca. per 100	Ordering Codes <sup>3</sup>	
			Thread	T	D2	L	L1 <sup>1</sup>	L2	L3	L4	i	S1			S2
L	6	500	G 1/8	14,9	20	28	13	21	10,5	8	14	14	14	4,31	FI-RST-06LR-WD-B-W3
	.24	7250		.59	.79	1.10	.51	.83	.41	.31	.55	.55	.55	9.48	
	8	500	G 1/4	18,8	21	29	14	27	13,5	10	19	19	17	8,60	FI-RST-08LR-WD-B-W3
	.31	7250		.74	.83	1.14	.55	1.06	.53	.39	.75	.75	.67	18.92	
	10	500	G 1/4	18,8	22	30	15	27	13,5	10	19	19	19	8,92	FI-RST-10LR-WD-B-W3
	.39	7250		.74	.87	1.18	.59	1.06	.53	.39	.75	.75	.75	19.63	
	12	400	G 3/8	22,8	24,5	32,5	17,5	32,5	16	12	24	22	22	14,78	FI-RST-12LR-WD-B-W3
	.47	5800		.90	.96	1.28	.69	1.28	.63	.47	.94	.87	.87	32.52	
	15	400	G 1/2	27,9	27	35	21	43	19,5	14	30	27	27	27,43	FI-RST-15LR-WD-B-W3
	.59	5800		1.10	1.06	1.38	.83	1.69	.77	.55	1.18	1.06	1.06	60.35	
	18	400	G 1/2	27,9	28	37	20,5	43	21,5	12	30	27	32	1,52	FI-RST-18LR-WD-B-W3
	.71	5800		1.10	1.10	1.46	.81	1.69	.85	.47	1.18	1.06	1.26	3.34	
	22	250	G 3/4	32,9	34,5	43,5	27	48	24	16	36	32	36	45,42	FI-RST-22LR-WD-B-W3
	.87	3625		1.30	1.36	1.71	1.06	1.89	.94	.63	1.42	1.26	1.42	99.91	
	28	250	G 1	40,9	39	48	31,5	59	30,5	18	46	41	41	85,48	FI-RST-28LR-WD-B-W3
	1.10	3625		1.61	1.54	1.89	1.24	2.32	1.20	.71	1.81	1.61	1.61	188.06	
	35	250	G 1 1/4	50,9	46	57	35,5	70	35,5	20	55	50	50	145,79	FI-RST-35LR-WD-B-W3
	1.38	3625		2.00	1.81	2.24	1.40	2.76	1.40	.79	2.17	1.97	1.97	320.75	
42	250	G 1 1/2	55,9	51	63	40	80	40,5	22	65	55	60	217,42	FI-RST-42LR-WD-B-W3	
1.65	3625		2.20	2.01	2.48	1.57	3.15	1.59	.87	2.56	2.17	2.36	478.33		
S	6	500	G 1/4	18,8	23	31	16	27	13,5	10	19	19	17	9,30	FI-RST-06SR-WD-B-W3
	.24	7250		.74	.91	1.22	.63	1.06	.53	.39	.75	.75	.67	20.46	
	8	500	G 1/4	18,8	23	31	16	27	13,5	10	19	19	19	9,97	FI-RST-08SR-WD-B-W3
	.31	7250		.74	.91	1.22	.63	1.06	.53	.39	.75	.75	.75	21.93	
	10	500	G 3/8	22,8	25,5	34,5	18	32,5	16	10	24	22	22	19,08	FI-RST-10SR-WD-B-W3
	.39	7250		.90	1.00	1.36	.71	1.28	.63	.39	.94	.87	.87	41.98	
	12	400	G 3/8	22,8	27	36	18	32,5	16	10	24	22	24	16,36	FI-RST-12SR-WD-B-W3
	.47	5800		.90	1.06	1.42	.71	1.28	.63	.39	.94	.87	.94	35.99	
	14	400	G 1/2	27,9	30	40	22	41	19,5	14	30	27	27	31,86	FI-RST-14SR-WD-B-W3
	.55	5800		1.10	1.18	1.57	.87	1.61	.77	.55	1.18	1.06	1.06	70.09	
	16	400	G 1/2	27,9	30	40	21,5	43	21,5	12	30	27	30	29,20	FI-RST-16SR-WD-B-W3
	.63	5800		1.10	1.18	1.57	.85	1.69	.85	.47	1.18	1.06	1.18	64.24	
	20	315	G 3/4	32,9	36,5	47,5	26	48	24	16	36	32	36	48,66	FI-RST-20SR-WD-B-W3
	.79	4568		1.30	1.44	1.87	1.02	1.89	.94	.63	1.42	1.26	1.42	107.05	
	25	250	G 1	40,9	43	55	31	59	30,5	18	46	41	46	93,55	FI-RST-25SR-WD-B-W3
	.98	3625		1.61	1.69	2.17	1.22	2.32	1.20	.71	1.81	1.61	1.81	205.80	
	30	250	G 1 1/4	50,9	50	63	36,5	70	35,5	20	55	50	50	153,59	FI-RST-30SR-WD-B-W3
	1.18	3625		2.00	1.97	2.48	1.44	2.76	1.40	.79	2.17	1.97	1.97	337.91	
38	250	G 1 1/2	55,9	57	72	41	80	40,5	22	65	55	60	236,22	FI-RST-38SR-WD-B-W3	
1.50	3625		2.20	2.24	2.83	1.61	3.15	1.59	.87	2.56	2.17	2.36	519.69		

<sup>1</sup> Approximate dimension in assembled condition.  
<sup>2</sup> Weight excluding cutting ring and union nut.  
<sup>3</sup> Standard scope of delivery: Fitting body only.

Port acc. to DIN 3852-2 (Form X) / ISO 1179-1

Male threaded studs were designed for female threaded ports in components made of steel. For applications with components made of softer mating materials (e.g. Aluminium), the use of connectors with additionally rolled male threads is recommended.

Please contact STAUFF prior to the assembly for further information.

Standard seal material is NBR (Buna-N®).

**Connecting Parts**

- Cutting Ring  
Type **FI-DS** Page 28
- Soft-Sealing Cutting Ring  
Type **FI-WDDS** Page 29
- Support Sleeve  
Type **FI-VH** Page 31
- STAUFF Form EVO Sealing Ring  
Type **FI-FD** Page 32
- Union Nut  
Type **FI-M** Page 33
- 37° Flared Tube Fitting Set  
Type **FI-AB** Page 37

**Spare Parts / Accessories**

- Retaining Ring with Captive Seal  
Type **FI-DIR** Page 245
- O-Ring  
Type **O-RING** Page 239



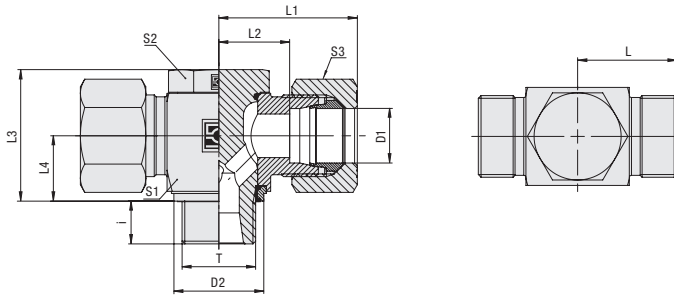

**Banjo Tee (High-Pressure Version)  
Type FI-RST-...-M-WD ■ Series L / S**

**Retaining Ring with Captive Seal**
**Metric Parallel Thread**

Series	Tube OD (mm/in)	PB (bar/psi)	Dimensions (mm/in)	Dimensions													Weight (%/lbs) ca. per 100	Ordering Codes <sup>3</sup>
				Thread	T	D2	L	L1 <sup>1</sup>	L2	L3	L4	i	S1	S2	S3			
L	6	500	M10x1	14,9	20	28	13	21	10	8	14	14	14	5,83	FI-RST-06LM-WD-B-W3			
	.24	7250		.59	.79	1.10	.51	.83	.39	.31	.55	.55	.55	12,83				
	8	500	M12x1,5	17,8	21	29	14	27	13,5	10	19	19	17	9,66	FI-RST-08LM-WD-B-W3			
	.31	7250		.70	.83	1.14	.55	1.06	.53	.39	.75	.75	.67	21,25				
	10	500	M14x1,5	19,9	22	30	15	27	13,5	10	19	19	19	13,25	FI-RST-10LM-WD-B-W3			
	.39	7250		.78	.87	1.18	.59	1.06	.53	.39	.75	.75	.75	29,15				
	12	400	M16x1,5	22,8	24,5	32,5	17,5	32,5	16	10	24	22	22	14,78	FI-RST-12LM-WD-B-W3			
	.47	5800		.90	.96	1.28	.69	1.28	.63	.39	.94	.87	.87	32,52				
	15	400	M18x1,5	24,9	27	35	20	37	18,5	10	27	24	27	23,90	FI-RST-15LM-WD-B-W3			
	.59	5800		.98	1.06	1.38	.79	1.46	.73	.39	1.06	.94	1.06	52,58				
	18	400	M22x1,5	27,9	28	37	20,5	43	21,5	12	30	27	32	29,91	FI-RST-18LM-WD-B-W3			
	.71	5800		1.10	1.10	1.46	.81	1.69	.85	.47	1.18	1.06	1.26	65,79				
	22	250	M26x1,5	32,5	34,5	43,5	27	48	24	16	36	32	36	42,56	FI-RST-22LM-WD-B-W3			
	.87	3625		1.28	1.36	1.71	1.06	1.89	.94	.63	1.42	1.26	1.42	93,64				
	28	250	M33x2	40,9	39	48	31,5	59	30,5	18	46	41	41	95,43	FI-RST-28LM-WD-B-W3			
	1.10	3625		1.61	1.54	1.89	1.24	2.32	1.20	.71	1.81	1.61	1.61	209,95				
	35	250	M42x2	50,9	46	57	35,5	70	35,5	20	55	50	50	145,36	FI-RST-35LM-WD-B-W3			
	1.38	3625		2.00	1.81	2.24	1.40	2.76	1.40	.79	2.17	1.97	1.97	319,78				
	42	250	M48x2	55,9	51	63	40	80	40,5	22	65	55	60	221,72	FI-RST-42LM-WD-B-W3			
	1.65	3625		2.20	2.01	2.48	1.57	3.15	1.59	.87	2.56	2.17	2.36	487,79				
S	6	500	M12x1,5	17,8	23	31	16	27	13,5	10	19	19	17	10,08	FI-RST-06SM-WD-B-W3			
	.24	7250		.70	.91	1.22	.63	1.06	.53	.39	.75	.75	.67	22,17				
	8	500	M14x1,5	19,9	23	31	16	27	13,5	10	19	19	19	10,12	FI-RST-08SM-WD-B-W3			
	.31	7250		.78	.91	1.22	.63	1.06	.53	.39	.75	.75	.75	22,26				
	10	500	M16x1,5	22,8	25,5	34,5	18	32,5	16	10	24	22	22	14,18	FI-RST-10SM-WD-B-W3			
	.39	7250		.90	1.00	1.36	.71	1.28	.63	.39	.94	.87	.87	31,19				
	12	400	M18x1,5	24,9	27	36	19,5	37	18,5	10	27	24	24	19,66	FI-RST-12SM-WD-B-W3			
	.47	5800		.98	1.06	1.42	.77	1.46	.73	.39	1.06	.94	.94	43,26				
	14	400	M20x1,5	27,5	30	40	22	41	19,5	12	30	27	27	29,38	FI-RST-14SM-WD-B-W3			
	.55	5800		1.08	1.18	1.57	.87	1.61	.77	.47	1.18	1.06	1.06	64,63				
	16	400	M22x1,5	27,9	30	40	21,5	43	21,5	12	30	27	30	35,10	FI-RST-16SM-WD-B-W3			
	.63	5800		1.10	1.18	1.57	.85	1.69	.85	.47	1.18	1.06	1.18	77,22				
	20	315	M27x2	32,9	36,5	47,5	26	48	24	16	36	32	36	45,86	FI-RST-20SM-WD-B-W3			
	.79	4568		1.30	1.44	1.87	1.02	1.89	.94	.63	1.42	1.26	1.42	100,89				
	25	250	M33x2	40,9	43	55	31	59	30,5	18	46	41	46	82,57	FI-RST-25SM-WD-B-W3			
	.98	3625		1.61	1.69	2.17	1.22	2.32	1.20	.71	1.81	1.61	1.81	181,64				
	30	250	M42x2	50,9	50	63	36,5	70	35,5	20	55	50	50	150,16	FI-RST-30SM-WD-B-W3			
1.18	3625		2.00	1.97	2.48	1.44	2.76	1.40	.79	2.17	1.97	1.97	330,36					
38	250	M48x2	55,9	57	72	41	80	40,5	22	65	55	60	236,35	FI-RST-38SM-WD-B-W3				
1.50	3625		2.20	2.24	2.83	1.61	3.15	1.59	.87	2.56	2.17	2.36	519,97					

<sup>1</sup> Approximate dimension in assembled condition.

<sup>2</sup> Weight excluding cutting ring and union nut.

<sup>3</sup> Standard scope of delivery: Fitting body only.

Standard seal material is NBR (Buna-N®).

Port acc. to DIN 3852-1 (Form X) / ISO 9974-1

Male threaded studs were designed for female threaded ports in components made of steel. For applications with components made of softer mating materials (e.g. Aluminium), the use of connectors with additionally rolled male threads is recommended.

Please contact STAUFF prior to the assembly for further information.

**Ordering Codes**
**\*FI-RST\*-10\*L\*M\*-WD\*-B\*-W3\*-MS**

* Banjo Tee (High-Pressure Version)	<b>FI-RST</b>
* Outside Tube Diameter D1 (in mm)	<b>-10</b>
* Series	Light Series <b>L</b> Heavy Series <b>S</b>
* Thread Type	Metric Parallel Thread <b>M</b>
If required, please indicate special sizes, e.g. M12x1.5!	
* Seal Type	Retaining Ring with Captive Seal <b>-WD</b>
* Seal Material	NBR (Buna-N®) <b>-B</b> FKM (Viton®) <b>-V</b> EPDM <b>-E</b>
* Material Code	Steel, zinc/nickel-plated <b>-W3</b>

Please contact STAUFF for alternative materials and surface finishings.

* Assembling / Kitting	Fitting body only	—
	Fitting body supplied with cutting ring and union nut	<b>-MS</b>
	Fitting body supplied with soft-sealing cutting ring and union nut	<b>-MSV</b>

**Connecting Parts**

	Cutting Ring Type <b>FI-DS</b>	Page 28
	Soft-Sealing Cutting Ring Type <b>FI-WDDS</b>	Page 29
	Support Sleeve Type <b>FI-VH</b>	Page 31
	STAUFF Form EVO Sealing Ring Type <b>FI-FD</b>	Page 32
	Union Nut Type <b>FI-M</b>	Page 33
	37° Flared Tube Fitting Set Type <b>FI-AB</b>	Page 37

**Spare Parts / Accessories**

	Retaining Ring with Captive Seal Type <b>FI-DIR</b>	Page 245
	O-Ring Type <b>O-RING</b>	Page 239





**Swivel Elbow**

FI-DGWE

196-197



**Whitworth Parallel Pipe Thread (BSPP) /  
Retaining Ring with Captive Seal**  
FI-DGWE-...-R-WD

196



**Metric Parallel Thread /  
Retaining Ring with Captive Seal**  
FI-DGWE-...-M-WD

197















L









	<b>Check Valve High-Pressure Version</b> FI-RV	200
	<b>Check Valve Standard Version</b> FI-RVA	201
	<b>Male Stud Check Valve (Flow from Stud End)</b> FI-RVV / FI-RVVA	202-205
	<b>Whitworth Parallel Pipe Thread (BSPP) / Profile Sealing Ring (High-Pressure Version)</b> FI-RVV-...-R-WD	202
	<b>Metric Parallel Thread / Profile Sealing Ring (High-Pressure Version)</b> FI-RVV-...-M-WD	203
	<b>Whitworth Parallel Pipe Thread (BSPP) / Profile Sealing Ring (Standard Version)</b> FI-RVVA-...-R-WD	204
	<b>Metric Parallel Thread / Profile Sealing Ring (Standard Version)</b> FI-RVVA-...-M-WD	205
	<b>Male Stud Check Valve (Flow to Stud End)</b> FI-RVZ / FI-RVZA	206-209
	<b>Whitworth Parallel Pipe Thread (BSPP) / Profile Sealing Ring (High-Pressure Version)</b> FI-RVZ-...-R-WD	206
	<b>Metric Parallel Thread / Profile Sealing Ring (High-Pressure Version)</b> FI-RVZ-...-M-WD	207
	<b>Whitworth Parallel Pipe Thread (BSPP) / Profile Sealing Ring (Standard Version)</b> FI-RVZA-...-R-WD	208
	<b>Metric Parallel Thread / Profile Sealing Ring (Standard Version)</b> FI-RVZA-...-M-WD	209
	<b>Female Stud Check Valve</b> FI-RVI / FI-RVIA	210-211
	<b>Female Whitworth Parallel Pipe Thread (BSPP) (High-Pressure Version)</b> FI-RVI-...-R	210
	<b>Female Whitworth Parallel Pipe Thread (BSPP) (Standard Version)</b> FI-RVIA-...-R	211
	<b>Check Valve Installation Kit</b> FI-VES	212
	<b>Alternating Valve</b> FI-WV	213



**Check Valve**  
**High-Pressure Version**  
**Type FI-RV • Series L / S**

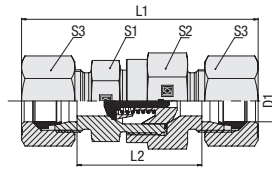

Standard Opening Pressure: 1 bar / 14.5 PSI

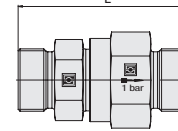

**Ordering Codes**

**\*FI-RV\*-10\*L\*-W3\*-1\*-MS**

- \* Check Valve **FI-RV**
- \* Outside Tube Diameter D1 (in mm) **-10**
- \* Series **L**  
**S**  
Light Series  
Heavy Series
- \* Material Code **-W3**  
Steel, zinc/nickel-plated
- Please contact STAUFF for alternative materials and surface finishings.
- \* Opening Pressure **1**  
1 bar / 14.5 PSI  
Contact STAUFF for alternative opening pressures.
- \* Assembling / Kitting **—**  
Valve body only
- MS**  
Valve body supplied with cutting rings and union nuts
- MSV**  
Valve body supplied with soft-sealing cutting rings and union nuts

**Connecting Parts**

- Cutting Ring  
Type **FI-DS** Page 28
- Soft-Sealing Cutting Ring  
Type **FI-WDDS** Page 29
- Support Sleeve  
Type **FI-VH** Page 31
- STAUFF Form EVO Sealing Ring  
Type **FI-FD** Page 32
- Union Nut  
Type **FI-M** Page 33
- 37° Flared Tube Fitting Set  
Type **FI-AB** Page 37

Series	Tube OD PN		Dimensions						Weight ( <sup>kg</sup> / <sub>lbs</sub> ) ca. per 100	Ordering Codes <sup>3</sup>
	(mm/in)	( <sup>mm</sup> / <sub>in</sub> )	(mm/in)	L1 <sup>1</sup>	L2	S1	S2	S3		
L	6	400	52	67	38	22	27	14	11,93	FI-RV-06L-W3-1
	.24	5800	2,05	2,64	1,50	.87	1,06	.55	26,24	
	8	400	52	67	38	22	27	17	12,41	FI-RV-08L-W3-1
	.31	5800	2,05	2,64	1,50	.87	1,06	.67	27,30	
	10	400	52	67	38	22	27	19	11,65	FI-RV-10L-W3-1
	.39	5800	2,05	2,64	1,50	.87	1,06	.75	25,64	
	12	400	53	68	39	22	27	22	12,31	FI-RV-12L-W3-1
	.47	5800	2,09	2,68	1,54	.87	1,06	.87	27,07	
	15	400	58	74	44	27	32	27	18,29	FI-RV-15L-W3-1
	.59	5800	2,28	2,91	1,73	1,06	1,26	1,06	40,25	
	18	400	63	80	48	27	32	32	22,54	FI-RV-18L-W3-1
	.71	5800	2,48	3,15	1,89	1,06	1,26	1,26	49,59	
	22	250	75	92	60	41	46	36	48,21	FI-RV-22L-W3-1
	.87	3625	2,95	3,62	2,36	1,61	1,81	1,42	106,05	
	28	250	81	99	66	41	46	41	57,90	FI-RV-28L-W3-1
	1.10	3625	3,19	3,90	2,60	1,61	1,81	1,61	127,38	
	35	250	92	114	71	60	70	50	129,80	FI-RV-35L-W3-1
	1.38	3625	3,62	4,49	2,80	2,36	2,76	1,97	285,56	
	42	250	87	111	65	60	70	60	122,60	FI-RV-42L-W3-1
	1.65	3625	3,43	4,37	2,56	2,36	2,76	2,36	269,72	
S	6	400	56	71	42	22	27	17	13,12	FI-RV-06S-W3-1
	.24	5800	2,20	2,80	1,65	.87	1,06	.67	28,87	
	8	400	52	67	38	22	27	19	11,98	FI-RV-08S-W3-1
	.31	5800	2,05	2,64	1,50	.87	1,06	.75	26,35	
	10	400	54	71	39	22	27	22	13,20	FI-RV-10S-W3-1
	.39	5800	2,13	2,80	1,54	.87	1,06	.87	29,04	
	12	400	55	72	40	22	27	24	13,61	FI-RV-12S-W3-1
	.47	5800	2,17	2,83	1,57	.87	1,06	.94	29,94	
	14	400	62	81	46	27	32	27	19,98	FI-RV-14S-W3-1
	.55	5800	2,44	3,19	1,81	1,06	1,26	1,06	43,96	
	16	400	65	84	48	27	32	30	21,56	FI-RV-16S-W3-1
	.63	5800	2,56	3,31	1,89	1,06	1,26	1,18	47,44	
	20	400	78	100	57	41	46	36	50,20	FI-RV-20S-W3-1
	.79	5800	3,07	3,94	2,24	1,61	1,81	1,42	110,45	
	25	250	81	105	57	41	46	46	52,60	FI-RV-25S-W3-1
	.98	3625	3,19	4,13	2,24	1,61	1,81	1,81	115,72	
	30	250	91	117	64	50	55	50	80,70	FI-RV-30S-W3-1
	1.18	3625	3,58	4,61	2,52	1,97	2,17	1,97	177,54	
	38	250	99	129	67	60	70	60	136,00	FI-RV-38S-W3-1
	1.50	3625	3,90	5,08	2,64	2,36	2,76	2,36	299,20	

<sup>1</sup> Approximate dimension in assembled condition.

<sup>2</sup> Weight excluding cutting rings and union nuts.

<sup>3</sup> Standard scope of delivery: Valve body only.

Opening pressure tolerance ± 20%.

Please note: Internal seals are made of FKM (Viton®).

In order to make sure that the valves will be suitable for your particular application, please contact STAUFF with details on media, operating pressure, pressure peaks, operating temperature and the expected frequency of valve actuations.





Check Valve  
Standard Version  
Type FI-RVA • Series L / S



Standard Opening Pressure: 1 bar / 14.5 PSI

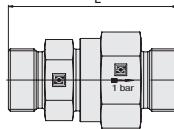
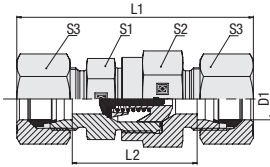

Series	Tube OD PB		Dimensions						Weight (kg/lbs) ca. per 100	Ordering Codes <sup>3</sup>
	(mm/in)	(bar/PSI)	(mm/in)	L1 <sup>1</sup>	L2	S1	S2	S3		
L	6	250	43	58	29	17	17	14	4,4	FI-RVA-06L-W3-1
	.24	3625	1.69	2.28	1.14	.67	.67	.55	9.7	
	8	250	44	59	30	19	19	17	5,5	FI-RVA-08L-W3-1
	.31	3625	1.73	2.32	1.18	.75	.75	.67	12.1	
	10	250	54,5	69,5	40,5	22	24	19	9,8	FI-RVA-10L-W3-1
	.39	3625	2.15	2.74	1.59	.87	.94	.75	21.6	
	12	250	57,5	72,5	43,5	27	30	22	16,5	FI-RVA-12L-W3-1
	.47	3625	2.26	2.85	1.71	1.06	1.18	.87	36.4	
	15	250	61,5	77,5	47,5	30	32	27	20,5	FI-RVA-15L-W3-1
	.59	3625	2.42	3.05	1.87	1.18	1.26	1.06	45.2	
	18	160	66,5	83,5	51,5	36	36	32	29,0	FI-RVA-18L-W3-1
	.71	2320	2.62	3.29	2.03	1.42	1.42	1.26	63.9	
	22	160	76,5	93,5	61,5	41	46	36	49,5	FI-RVA-22L-W3-1
	.87	2320	3.01	3.68	2.42	1.61	1.81	1.42	109.1	
	28	100	85	103	70	50	55	41	78,4	FI-RVA-28L-W3-1
	1.10	1450	3.35	4.06	2.76	1.97	2.17	1.61	172.8	
	35	100	95,5	117,5	74,5	60	65	50	122,7	FI-RVA-35L-W3-1
	1.38	1450	3.76	4.63	2.93	2.36	2.56	1.97	270.5	
42	100	99,5	123,5	77,5	65	75	60	162,6	FI-RVA-42L-W3-1	
1.65	1450	3.92	4.86	3.05	2.56	2.95	2.36	358.5		
S	6	630	48,5	63,5	34,5	19	19	17	6,6	FI-RVA-06S-W3-1
	.24	9137	1.91	2.5	1.36	.75	.75	.67	14.6	
	8	630	48,5	63,5	34,5	19	19	19	6,8	FI-RVA-08S-W3-1
	.31	9137	1.91	2.5	1.36	.75	.75	.75	14.9	
	10	630	55,5	72,5	40,5	22	24	22	11,5	FI-RVA-10S-W3-1
	.39	9137	2.19	2.85	1.59	.87	.94	.87	25.4	
	12	630	57,5	74,5	42,5	24	27	24	14,5	FI-RVA-12S-W3-1
	.47	9137	2.26	2.93	1.67	.94	1.06	.94	35.0	
	14	630	63,5	82,5	47,5	27	32	27	20,9	FI-RVA-14S-W3-1
	.55	9137	2.5	3.25	1.87	1.06	1.26	1.06	46.1	
	16	400	67,5	86,5	50,5	32	36	30	27,8	FI-RVA-16S-W3-1
	.63	5801	2.66	3.41	1.99	1.26	1.42	1.18	61,3	
	20	400	75,5	97,5	54,5	41	46	36	49,5	FI-RVA-20S-W3-1
	.79	5801	2.97	3.84	2.15	1.61	1.81	1.42	109.1	
	25	400	82,5	106,5	58,5	46	50	46	62,7	FI-RVA-25S-W3-1
	.98	5801	3.25	4.19	2.3	1.81	1.97	1.81	138.2	
	30	250	96	122	69	55	60	50	107,8	FI-RVA-30S-W3-1
	1.18	3625	3.78	4.8	2.72	2.17	2.36	1.97	237.7	
38	250	107,5	137,5	75,5	65	70	60	161,3	FI-RVA-38S-W3-1	
1.50	3625	4.23	5.41	2.97	2.56	2.76	2.36	355.6		

<sup>1</sup> Approximate dimension in assembled condition.

Opening pressure tolerance ± 20%.

<sup>2</sup> Weight excluding cutting rings and union nuts.

<sup>3</sup> Standard scope of delivery: Valve body only.

Please note: Internal seals are made of FKM (Viton®).

In order to make sure that the valves will be suitable for your particular application, please contact STAUFF with details on media, operating pressure, pressure peaks, operating temperature and the expected frequency of valve actuations.

Ordering Codes

\*FI-RVA\*-10\*L\*-W3\*-1\*-MS

* Check Valve	FI-RVA
* Outside Tube Diameter D1 (in mm)	-10
* Series	Light Series L Heavy Series S
* Material Code	Steel, zinc/nickel-plated -W3
Please contact STAUFF for alternative materials and surface finishings.	
* Opening Pressure	1 bar / 14.5 PSI 1
Contact STAUFF for alternative opening pressures.	
* Assembling / Kitting	Valve body only —
	Valve body supplied with cutting rings and union nuts -MS
	Valve body supplied with soft-sealing cutting rings and union nuts -MSV

Connecting Parts

	Cutting Ring Type FI-DS	Page 28
	Soft-Sealing Cutting Ring Type FI-WDDS	Page 29
	Support Sleeve Type FI-VH	Page 31
	STAUFF Form EVO Sealing Ring Type FI-FD	Page 32
	Union Nut Type FI-M	Page 33
	37° Flared Tube Fitting Set Type FI-AB	Page 37

M



### Male Stud Check Valve High-Pressure Version Type FI-RVV-...-R-WD • Series L / S

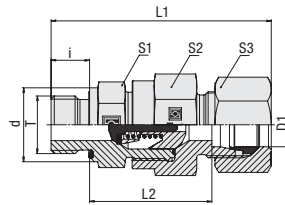

Flow Direction: A > B (from Stud End)  
Standard Opening Pressure: 1 bar / 14.5 PSI

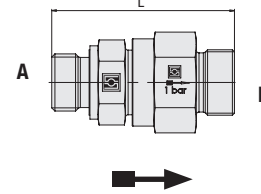

#### Ordering Codes

- \*FI-RVV\*-10\*L\*R\*-WD\*-B\*-W3\*-1\*-MS**
- \* Male Stud Check Valve (Flow from Stud End) **FI-RVV****
- \* Outside Tube Diameter D1 (in mm) **-10****
- \* Series**  
Light Series **L**  
Heavy Series **S**
- \* Thread Type**  
Whitworth Parallel Pipe Thread (BSPP) **R**
- If required, please indicate special sizes, e.g. R1/8!
- \* Seal Type**  
Profile Sealing Ring **-WD**
- \* Seal Material**  
NBR (Buna-N®) **-B**  
FKM (Viton®) **-V**  
EPDM **-E**
- \* Material Code**  
Steel, zinc/nickel-plated **-W3**
- Please contact STAUFF for alternative materials and surface finishings.
- \* Opening Pressure**  
1 bar / 14.5 PSI **1**  
Contact STAUFF for alternative opening pressures.
- \* Assembling / Kitting**  
Valve body only **—**  
Valve body supplied with cutting ring and union nut **-MS**  
Valve body supplied with soft-sealing cutting ring and union nut **-MSV**

#### Connecting Parts

- Cutting Ring  
Type **FI-DS** Page 28
- Soft-Sealing Cutting Ring  
Type **FI-WDDS** Page 29
- Support Sleeve  
Type **FI-VH** Page 31
- STAUFF Form EVO Sealing Ring  
Type **FI-FD** Page 32
- Union Nut  
Type **FI-M** Page 33
- 37° Flared Tube Fitting Set  
Type **FI-AB** Page 37

#### Spare Parts / Accessories

- Profile Sealing Ring  
Type **WDG** Page 238

#### Whitworth Parallel Pipe Thread (BSPP)

#### Profile Sealing Ring

Series	Tube OD (mm/in)	PN (bar/PSI)	Dimensions (mm/in)										Torque (N·m/ft·lb)	Weight (kg/lbs) ca.	Ordering Codes <sup>3</sup>
			Thread	T	d	L	L1 <sup>1</sup>	L2	i	S1	S2	S3			
L	6	400	G 1/8	13,9	51	59	36	8	22	27	14	18	11,69	FI-RVV-06LR-WD-B-W3-1	
	.24	5800	G 1/8	.55	2.01	2.32	1.42	.31	.87	1.06	.55	13.3	25.71	FI-RVV-06LR-WD-B-W3-1	
	8	400	G 1/4	18,9	55	63	36	12	22	27	17	35	12,54	FI-RVV-08LR-WD-B-W3-1	
	.31	5800	G 1/4	.74	2.17	2.48	1.42	.47	.87	1.06	.67	25.8	27.58	FI-RVV-08LR-WD-B-W3-1	
	10	400	G 1/4	18,9	53	61	34	12	22	27	19	35	11,40	FI-RVV-10LR-WD-B-W3-1	
	.39	5800	G 1/4	.74	2.09	2.40	1.34	.47	.87	1.06	.75	25.8	25.08	FI-RVV-10LR-WD-B-W3-1	
	12	400	G 3/8	21,9	58	66	39	12	22	27	22	70	13,62	FI-RVV-12LR-WD-B-W3-1	
	.47	5800	G 3/8	.86	2.28	2.60	1.54	.47	.87	1.06	.87	51.8	29.97	FI-RVV-12LR-WD-B-W3-1	
	15	400	G 1/2	26,9	60	68	41	14	27	32	27	90	19,68	FI-RVV-15LR-WD-B-W3-1	
	.59	5800	G 1/2	1.06	2.36	2.68	1.61	.55	1.06	1.26	1.06	66.6	43.30	FI-RVV-15LR-WD-B-W3-1	
	18	400	G 1/2	26,9	67	76	45,5	14	27	32	32	90	22,68	FI-RVV-18LR-WD-B-W3-1	
	.71	5800	G 1/2	1.06	2.64	2.99	1.79	.55	1.06	1.26	1.26	66.6	49.89	FI-RVV-18LR-WD-B-W3-1	
	22	250	G 3/4	31,9	77	86	53,5	16	41	46	36	180	46,49	FI-RVV-22LR-WD-B-W3-1	
	.87	3625	G 3/4	1.26	3.03	3.39	2.11	.63	1.61	1.81	1.42	133.2	102.28	FI-RVV-22LR-WD-B-W3-1	
	28	250	G 1	39,9	86	95	60,5	18	41	46	41	310	59,70	FI-RVV-28LR-WD-B-W3-1	
	1.10	3625	G 1	1.57	3.39	3.74	2.38	.71	1.61	1.81	1.61	229.4	131.34	FI-RVV-28LR-WD-B-W3-1	
	35	250	G 1 1/4	49,9	97,5	108,5	67	20	60	70	50	450	132,20	FI-RVV-35LR-WD-B-W3-1	
1.38	3625	G 1 1/4	1.96	3.84	4.27	2.64	.79	2.36	2.76	1.97	333.0	290.84	FI-RVV-35LR-WD-B-W3-1		
42	250	G 1 1/2	54,9	97,5	109,5	64,5	22	60	70	60	540	137,40	FI-RVV-42LR-WD-B-W3-1		
1.65	3625	G 1 1/2	2.16	3.84	4.31	2.54	.87	2.36	2.76	2.36	399.6	302.28	FI-RVV-42LR-WD-B-W3-1		
S	6	400	G 1/4	18,9	57	65	38	12	22	27	17	55	12,95	FI-RVV-06SR-WD-B-W3-1	
	.24	5800	G 1/4	.74	2.24	2.56	1.50	.47	.87	1.06	.67	40.7	28.49	FI-RVV-06SR-WD-B-W3-1	
	8	400	G 1/4	18,9	55	63	36	12	22	27	19	55	12,12	FI-RVV-08SR-WD-B-W3-1	
	.31	5800	G 1/4	.74	2.17	2.48	1.42	.47	.87	1.06	.75	40.7	26.66	FI-RVV-08SR-WD-B-W3-1	
	10	400	G 3/8	21,9	57	66	37,5	12	22	27	22	80	13,32	FI-RVV-10SR-WD-B-W3-1	
	.39	5800	G 3/8	.86	2.24	2.60	1.48	.47	.87	1.06	.87	59.2	29.30	FI-RVV-10SR-WD-B-W3-1	
	12	400	G 3/8	21,9	59	68	39,5	12	22	27	24	80	14,64	FI-RVV-12SR-WD-B-W3-1	
	.47	5800	G 3/8	.86	2.32	2.68	1.56	.47	.87	1.06	.94	59.2	32.21	FI-RVV-12SR-WD-B-W3-1	
	14	400	G 1/2	26,9	64	74	42	14	27	32	27	115	20,26	FI-RVV-14SR-WD-B-W3-1	
	.55	5800	G 1/2	1.06	2.52	2.91	1.65	.55	1.06	1.26	1.06	85.1	44.57	FI-RVV-14SR-WD-B-W3-1	
	16	400	G 1/2	26,9	67	77	44,5	14	27	32	30	115	21,59	FI-RVV-16SR-WD-B-W3-1	
	.63	5800	G 1/2	1.06	2.64	3.03	1.75	.55	1.06	1.26	1.18	85.1	47.50	FI-RVV-16SR-WD-B-W3-1	
	20	400	G 3/4	31,9	79	90	52,5	16	41	46	36	180	50,90	FI-RVV-20SR-WD-B-W3-1	
	.79	5800	G 3/4	1.26	3.11	3.54	2.07	.63	1.61	1.81	1.42	133.2	111.98	FI-RVV-20SR-WD-B-W3-1	
	25	250	G 1	39,9	83	95	53	18	41	46	46	310	53,10	FI-RVV-25SR-WD-B-W3-1	
	.98	3625	G 1	1.57	3.27	3.74	2.09	.71	1.61	1.81	1.81	229.4	116.82	FI-RVV-25SR-WD-B-W3-1	
30	250	G 1 1/4	49,9	94	107	60,5	20	50	55	50	450	86,00	FI-RVV-30SR-WD-B-W3-1		
1.18	3625	G 1 1/4	1.96	3.70	4.21	2.38	.79	1.97	2.17	1.97	333.0	189.20	FI-RVV-30SR-WD-B-W3-1		
38	250	G 1 1/2	54,9	103,5	118,5	65,5	22	60	70	60	540	143,70	FI-RVV-38SR-WD-B-W3-1		
1.50	3625	G 1 1/2	2.16	4.07	4.67	2.58	.87	2.36	2.76	2.36	399.6	316.14	FI-RVV-38SR-WD-B-W3-1		

<sup>1</sup> Approximate dimension in assembled condition.  
<sup>2</sup> Weight excluding cutting ring and union nut.  
<sup>3</sup> Standard scope of delivery: Valve body only.

Male stud acc. to ISO 1179-2 (Type E)  
Port acc. to ISO 1179-1

Standard seal material is NBR (Buna-N®).  
Please note: Internal seals are made of FKM (Viton®).

Torque recommendations for Steel mating material.

In order to make sure that the valves will be suitable for your particular application, please contact STAUFF with details on media, operating pressure, pressure peaks, operating temperature and the expected frequency of valve actuations.

Male threaded studs were designed for female threaded ports in components made of steel. For applications with components made of softer mating materials (e.g. Aluminium), the use of connectors with additionally rolled male threads is recommended.  
Please contact STAUFF prior to the assembly for further information.

Opening pressure tolerance ± 20%.



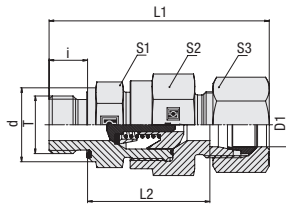

Flow Direction: A > B (from Stud End)  
Standard Opening Pressure: 1 bar / 14.5 PSI

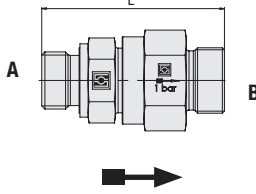

## Male Stud Check Valve High-Pressure Version Type FI-RVV-...-M-WD • Series L / S



### Profile Sealing Ring

### Metric Parallel Thread

Series	Tube OD D1 (mm/in)	PN (bar/PSI)	Dimensions (mm/in)										Torque (N-m/ft-lb)	Weight (kg/lbs) CA.	Ordering Codes <sup>3</sup>	
			Thread	T	d	L	L <sup>1</sup>	L <sup>2</sup>	i	S1	S2	S3				Thread T
L	6	400	M 10 x 1	13,9	51	59	36	8	22	27	14	18	10,58		FI-RVV-06LM-WD-B-W3-1	
	.24	5800		.55	2.01	2.32	1.42	.31	.87	1.06	.55	13.3	23.27			
	8	400	M 12 x 1,5	16,9	55	63	36	12	22	27	17	25	12,28		FI-RVV-08LM-WD-B-W3-1	
	.31	5800		.67	2.17	2.48	1.42	.47	.87	1.06	.67	18.5	27.02			
	10	400	M 14 x 1,5	18,9	53	61	34	12	22	27	19	45	11,39		FI-RVV-10LM-WD-B-W3-1	
	.39	5800		.74	2.09	2.40	1.34	.47	.87	1.06	.75	33.3	25.06			
	12	400	M 16 x 1,5	21,9	58	66	39	12	22	27	22	55	13,50		FI-RVV-12LM-WD-B-W3-1	
	.47	5800		.86	2.28	2.60	1.54	.47	.87	1.06	.87	40.7	29.69			
	15	400	M 18 x 1,5	23,9	60	68	41	12	27	32	27	70	18,42		FI-RVV-15LM-WD-B-W3-1	
	.59	5800		.94	2.36	2.68	1.61	.47	1.06	1.26	1.06	51.8	40.52			
	18	400	M 22 x 1,5	26,9	67	76	45,5	14	27	32	32	125	23,09		FI-RVV-18LM-WD-B-W3-1	
	.71	5800		1.06	2.64	2.99	1.79	.55	1.06	1.26	1.26	92.5	50.80			
	22	250	M 26 x 1,5	31,9	77	86	53,5	16	41	46	36	180	46,70		FI-RVV-22LM-WD-B-W3-1	
	.87	3625		1.26	3.03	3.39	2.11	.63	1.61	1.81	1.42	133.2	102.74			
	28	250	M 33 x 2	39,9	86	95	60,5	18	41	46	41	310	59,70		FI-RVV-28LM-WD-B-W3-1	
	1.10	3625		1.57	3.39	3.74	2.38	.71	1.61	1.81	1.61	229.4	131.34			
	35	250	M 42 x 2	49,9	97,5	108,5	67	20	60	70	50	450	132,20		FI-RVV-35LM-WD-B-W3-1	
	1.38	3625		1.96	3.84	4.27	2.64	.79	2.36	2.76	1.97	333.0	290.84			
	42	250	M 48 x 2	54,9	97,5	109,5	64,5	22	60	70	60	540	137,20		FI-RVV-42LM-WD-B-W3-1	
	1.65	3625		2.16	3.84	4.31	2.54	.87	2.36	2.76	2.36	399.6	301.84			
	S	6	400	M 12 x 1,5	16,9	57	65	38	12	22	27	17	35	11,23		FI-RVV-06SM-WD-B-W3-1
		.24	5800		.67	2.24	2.56	1.50	.47	.87	1.06	.67	25.9	24.70		
		8	400	M 14 x 1,5	18,9	55	63	36	12	22	27	19	55	11,55		FI-RVV-08SM-WD-B-W3-1
		.31	5800		.74	2.17	2.48	1.42	.47	.87	1.06	.75	40.7	25.42		
10		400	M 16 x 1,5	21,9	57	66	37,5	12	22	27	22	70	13,29		FI-RVV-10SM-WD-B-W3-1	
.39		5800		.86	2.24	2.60	1.48	.47	.87	1.06	.87	51.8	29.23			
12		400	M 18 x 1,5	23,9	59	68	39,5	12	24	27	24	90	15,56		FI-RVV-12SM-WD-B-W3-1	
.47		5800		.94	2.32	2.68	1.56	.47	.94	1.06	.94	66.6	34.22			
14		400	M 20 x 1,5	25,9	64	74	42	14	27	32	27	125	19,94		FI-RVV-14SM-WD-B-W3-1	
.55		5800		1.02	2.52	2.91	1.65	.55	1.06	1.26	1.06	92.5	43.87			
16		400	M 22 x 1,5	26,9	67	77	44,5	14	27	32	30	135	21,40		FI-RVV-16SM-WD-B-W3-1	
.63		5800		1.06	2.64	3.03	1.75	.55	1.06	1.26	1.18	99.9	47.08			
20		400	M 27 x 2	31,9	79	90	52,5	16	41	46	36	180	50,99		FI-RVV-20SM-WD-B-W3-1	
.79		5800		1.26	3.11	3.54	2.07	.63	1.61	1.81	1.42	133.2	112.18			
25		250	M 33 x 2	39,9	83	95	53	18	41	46	46	310	53,50		FI-RVV-25SM-WD-B-W3-1	
.98		3625		1.57	3.27	3.74	2.09	.71	1.61	1.81	1.81	229.4	117.70			
30		250	M 42 x 2	49,9	94	107	60,5	20	50	55	50	450	86,80		FI-RVV-30SM-WD-B-W3-1	
1.18		3625		1.96	3.70	4.21	2.38	.79	1.97	2.17	1.97	333.0	190.96			
38		250	M 48 x 2	54,9	104	119	66	22	60	70	60	540	144,70		FI-RVV-38SM-WD-B-W3-1	
1.50		3625		2.16	4.09	4.69	2.60	.87	2.36	2.76	2.36	399.6	318.34			

<sup>1</sup> Approximate dimension in assembled condition.  
<sup>2</sup> Weight excluding cutting ring and union nut.  
<sup>3</sup> Standard scope of delivery: Valve body only.

Male stud acc. to ISO 9974-2 (Type E)  
 Port acc. to ISO 9974-1

Torque recommendations for Steel mating material.

Standard seal material is NBR (Buna-N®).  
 Please note: Internal seals are made of FKM (Viton®).

Male threaded studs were designed for female threaded ports in components made of steel. For applications with components made of softer mating materials (e.g. Aluminium), the use of connectors with additionally rolled male threads is recommended.  
 Please contact STAUFF prior to the assembly for further information.

Opening pressure tolerance ± 20%.

In order to make sure that the valves will be suitable for your particular application, please contact STAUFF with details on media, operating pressure, pressure peaks, operating temperature and the expected frequency of valve actuations.

### Ordering Codes

**\*FI-RVV\*-10\*L\*M\*-WD\*-B\*-W3\*-1\*-MS**

\* Male Stud Check Valve (Flow from Stud End) **FI-RVV**

\* Outside Tube Diameter D1 (in mm) **-10**

\* Series Light Series **L**  
Heavy Series **S**

\* Thread Type Metric Parallel Thread **M**

If required, please indicate special sizes, e.g. M12x1.5!

\* Seal Type Profile Sealing Ring **-WD**

\* Seal Material NBR (Buna-N®) **-B**  
FKM (Viton®) **-V**  
EPDM **-E**

\* Material Code Steel, zinc/nickel-plated **-W3**

Please contact STAUFF for alternative materials and surface finishings.

\* Opening Pressure 1 bar / 14.5 PSI **1**

Contact STAUFF for alternative opening pressures.

\* Assembling / Kitting Fitting body only **—**

Valve body supplied with cutting ring and union nut **-MS**

Valve body supplied with soft-sealing cutting ring and union nut **-MSV**

### Connecting Parts

Cutting Ring  
Type **FI-DS** Page 28

Soft-Sealing Cutting Ring  
Type **FI-WDDS** Page 29

Support Sleeve  
Type **FI-VH** Page 31

STAUFF Form EVO Sealing Ring  
Type **FI-FD** Page 32

Union Nut  
Type **FI-M** Page 33

37° Flared Tube Fitting Set  
Type **FI-AB** Page 37

### Spare Parts / Accessories

Profile Sealing Ring  
Type **WDG** Page 238



# Male Stud Check Valve Standard Version Type FI-RVVA-...-R-WD • Series L / S

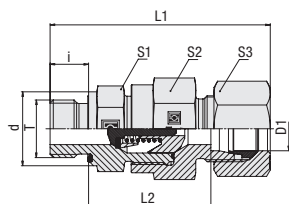

Flow Direction: A > B (from Stud End)  
Standard Opening Pressure: 1 bar / 14.5 PSI

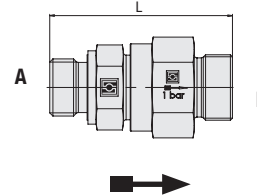

### Ordering Codes

- \*FI-RVVA\*-10\*L\*R\*-WD\*-B\*-W3\*-1\*-MS**
- \* Male Stud Check Valve (Flow from Stud End) **FI-RVVA**
- \* Outside Tube Diameter D1 (in mm) **-10**
- \* Series Light Series **L**  
Heavy Series **S**
- \* Thread Type Whitworth Parallel Pipe Thread (BSPP) **R**
- If required, please indicate special sizes, e.g. R1/8!
- \* Seal Type Profile Sealing Ring **-WD**
- \* Seal Material NBR (Buna-N®) **-B**  
FKM (Viton®) **-V**  
EPDM **-E**
- \* Material Code Steel, zinc/nickel-plated **-W3**
- Please contact STAUFF for alternative materials and surface finishings.
- \* Opening Pressure 1 bar / 14.5 PSI **1**
- Contact STAUFF for alternative opening pressures.
- \* Assembling / Kitting Valve body only **—**
- Valve body supplied with cutting ring and union nut **-MS**
- Valve body supplied with soft-sealing cutting ring and union nut **-MSV**

### Connecting Parts

- Cutting Ring Type **FI-DS** Page 28
- Soft-Sealing Cutting Ring Type **FI-WDDS** Page 29
- Support Sleeve Type **FI-VH** Page 31
- STAUFF Form EVO Sealing Ring Type **FI-FD** Page 32
- Union Nut Type **FI-M** Page 33
- 37° Flared Tube Fitting Set Type **FI-AB** Page 37

### Spare Parts / Accessories

- Profile Sealing Ring Type **WDG** Page 238

### Whitworth Parallel Pipe Thread (BSPP)

### Profile Sealing Ring

Series	Tube OD (mm/in)	PB (bar/PSI)	Dimensions (mm/in)										Torque (N·m/ft·lb)	Weight (kg/lbs) ca.	Ordering Codes <sup>3</sup>
			Thread	T	d	L	L1 <sup>1</sup>	L2	i	S1	S2	S3			
L	6	250	G 1/8	13,9	44	52	29	8	17	17	14	18	5,7	FI-RVVA-06LR-WD-B-W3-1	
	.24	3625		.55	1.73	2.05	1.14	.31	.67	.67	.55	13.3	12.57		
	8	250	G 1/4	18,9	49	57	30	12	19	19	17	35	6,2	FI-RVVA-08LR-WD-B-W3-1	
	.31	3625		.74	1.93	2.24	1.18	.47	.75	.75	.67	25.8	13.67		
	10	250	G 1/4	18,9	59,5	67,5	40,5	12	22	24	19	35	10,6	FI-RVVA-10LR-WD-B-W3-1	
	.39	3625		.74	2.34	2.66	1.59	.47	.87	.94	.75	25.8	23.37		
	12	250	G 3/8	21,9	61,5	69,5	42,5	12	27	30	22	70	17,2	FI-RVVA-12LR-WD-B-W3-1	
	.47	3625		.86	2.42	2.74	1.67	.47	1.06	1.18	.87	51.8	37.92		
	15	250	G 1/2	26,9	66,5	74,5	45,5	14	30	32	27	90	21,9	FI-RVVA-15LR-WD-B-W3-1	
	.59	3625		1.06	2.61	2.93	1.79	.55	1.18	1.26	1.06	66.6	48.28		
	18	160	G 1/2	26,9	72,5	81,5	51	14	36	36	32	90	30,1	FI-RVVA-18LR-WD-B-W3-1	
	.71	2320		1.06	2.85	3.21	2.01	.55	1.42	1.42	1.26	66.6	66.36		
	22	160	G 3/4	31,9	80	89	56,5	16	41	46	36	180	48,8	FI-RVVA-22LR-WD-B-W3-1	
	.87	2320		1.26	3.15	3.50	2.22	.63	1.61	1.81	1.42	133.2	107.59		
	28	100	G 1	39,9	92	101	66,5	18	50	55	41	310	81,0	FI-RVVA-28LR-WD-B-W3-1	
	1.10	1450		1.57	3.62	3.98	2.62	.71	1.97	2.17	1.61	229.4	178.57		
	35	100	G 1 1/4	49,9	102,5	113,5	72	20	60	65	50	450	126,6	FI-RVVA-35LR-WD-B-W3-1	
	1.38	1450		1.96	4.04	4.47	2.83	.79	2.36	2.56	1.97	333.0	279.11		
42	100	G 1 1/2	54,9	109,5	121,5	76,5	22	65	75	60	540	170,1	FI-RVVA-42LR-WD-B-W3-1		
1.65	1450		2.16	4.31	4.78	3.01	.87	2.56	2.95	2.36	399.6	375.01			
S	6	630	G 1/4	18,9	50,5	58,5	31,5	12	19	19	17	55	7,0	FI-RVVA-06SR-WD-B-W3-1	
	.24	9137		.74	1.99	2.30	1.24	.47	.75	.75	.67	40.7	15.43		
	8	630	G 1/4	18,9	50,5	58,5	31,5	12	19	19	19	55	6,8	FI-RVVA-08SR-WD-B-W3-1	
	.31	9137		.74	1.99	2.30	1.24	.47	.75	.75	.75	40.7	14.99		
	10	630	G 3/8	21,9	57,5	66,5	38	12	22	24	22	80	12,0	FI-RVVA-10SR-WD-B-W3-1	
	.39	9137		.86	2.26	2.62	1.50	.47	.87	.94	.87	59.2	26.46		
	12	630	G 3/8	21,9	60,5	69,5	41	12	24	27	24	80	14,9	FI-RVVA-12SR-WD-B-W3-1	
	.47	9137		.86	2.38	2.74	1.61	.47	.94	1.06	.94	59.2	32.85		
	14	630	G 1/2	26,9	66,5	76,5	44,5	14	27	32	27	115	22,2	FI-RVVA-14SR-WD-B-W3-1	
	.55	9137		1.06	2.62	3.01	1.75	.55	1.06	1.26	1.06	85.1	48.94		
	16	400	G 1/2	26,9	70,5	80,5	48	14	32	36	30	115	28,1	FI-RVVA-16SR-WD-B-W3-1	
	.63	5801		1.06	2.78	3.17	1.89	.55	1.26	1.42	1.18	85.1	61.95		
	20	400	G 3/4	31,9	78,5	89,5	52	16	41	46	36	180	50,2	FI-RVVA-20SR-WD-B-W3-1	
	.79	5801		1.26	3.09	3.52	2.04	.63	1.61	1.81	1.42	133.2	110.67		
	25	400	G 1	39,9	87,5	99,5	57,5	18	46	50	46	310	65,7	FI-RVVA-25SR-WD-B-W3-1	
	.98	5801		1.57	3.44	3.92	2.26	.71	1.81	1.97	1.81	229.4	144.85		
	30	250	G 1 1/4	49,9	97,5	110,5	64	20	55	60	50	450	108,2	FI-RVVA-30SR-WD-B-W3-1	
	1.18	3625		1.96	3.84	4.35	2.52	.79	2.17	2.36	1.97	333.0	238.54		
38	250	G 1 1/2	54,9	109,5	124,5	71,5	22	65	70	60	540	162,1	FI-RVVA-38SR-WD-B-W3-1		
1.50	3625		2.16	4.31	4.90	2.81	.87	2.56	2.76	2.36	399.6	357.37			

<sup>1</sup> Approximate dimension in assembled condition.

<sup>2</sup> Weight excluding cutting ring and union nut.

<sup>3</sup> Standard scope of delivery: Valve body only.

Standard seal material is NBR (Buna-N®).

Please note: Internal seals are made of FKM (Viton®).

In order to make sure that the valves will be suitable for your particular application, please contact STAUFF with details on media, operating pressure, pressure peaks, operating temperature and the expected frequency of valve actuations.

Male stud acc. to ISO 1179-2 (Type E)

Port acc. to ISO 1179-1

Torque recommendations for Steel mating material.

Male threaded studs were designed for female threaded ports in components made of steel. For applications with components made of softer mating materials (e.g. Aluminium), the use of connectors with additionally rolled male threads is recommended.

Please contact STAUFF prior to the assembly for further information.

Opening pressure tolerance ± 20%.



**Male Stud Check Valve  
Standard Version  
Type FI-RVVA-...-M-WD • Series L / S**

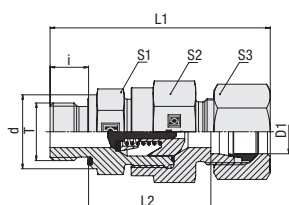

Flow Direction: A > B (from Stud End)  
Standard Opening Pressure: 1 bar / 14.5 PSI

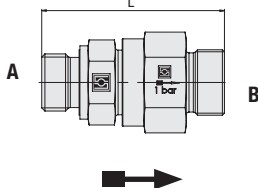

**Profile Sealing Ring**

**Metric Parallel Thread**

Series	Tube OD (mm/in)	PB (bar/PSI)	Dimensions (mm/in)										Torque (N·m/ft·lb)	Weight (kg/lbs) CA.	Ordering Codes <sup>3</sup>
			Thread	T	d	L	L <sup>1</sup>	L <sup>2</sup>	i	S <sup>1</sup>	S <sup>2</sup>	S <sup>3</sup>			
L	6	250	M 10 x 1	13,9	44	52	29	8	17	17	14	18	4,6	FI-RVVA-06LM-WD-B-W3-1	
	.24	3625		.55	1.73	2.05	1.14	.31	.67	.67	.55	13,3	10,14		
	8	250	M 12 x 1,5	16,9	48	56	29	12	19	19	17	25	7,5	FI-RVVA-08LM-WD-B-W3-1	
	.31	3625		.67	1.89	2.20	1.14	.47	.75	.75	.67	18,5	16,53		
	10	250	M 14 x 1,5	18,9	59	67	40	12	22	24	19	45	10,6	FI-RVVA-10LM-WD-B-W3-1	
	.39	3625		.74	2.32	2.64	1.57	.47	.87	.94	.75	33,3	23,37		
	12	250	M 16 x 1,5	21,9	61,5	69,5	42,5	12	27	30	22	55	17,3	FI-RVVA-12LM-WD-B-W3-1	
	.47	3625		.86	2.42	2.74	1.67	.47	1.06	1.18	.87	40,7	38,14		
	15	250	M 18 x 1,5	23,9	64,5	72,5	45,5	12	30	32	27	70	20,8	FI-RVVA-15LM-WD-B-W3-1	
	.59	3625		.94	2.54	2.85	1.79	.47	1.18	1.26	1.06	51,8	45,86		
	18	160	M 22 x 1,5	26,9	71,5	80,5	50	14	36	36	32	125	36,6	FI-RVVA-18LM-WD-B-W3-1	
	.71	2320		1.06	2.81	3.17	1.96	.55	1.42	1.42	1.26	92,5	80,69		
	22	160	M 26 x 1,5	31,9	81	90	57,5	16	41	46	36	180	49,9	FI-RVVA-22LM-WD-B-W3-1	
	.87	2320		1.26	3.19	3.54	2.26	.63	1.61	1.81	1.42	133,2	110,01		
	28	100	M 33 x 2	39,9	92	101	66,5	18	50	55	41	310	81,5	FI-RVVA-28LM-WD-B-W3-1	
	1.10	1450		1.57	3.62	3.98	2.61	.71	1.97	2.17	1.61	229,4	179,68		
	35	100	M 42 x 2	49,9	101,5	112,5	71	20	60	65	50	450	124,8	FI-RVVA-35LM-WD-B-W3-1	
	1.38	1450		1.96	3.99	4.43	2.79	.79	2.36	2.56	1.97	333,0	275,14		
	42	100	M 48 x 2	54,9	109,5	121,5	76,5	22	65	75	60	540	169,6	FI-RVVA-42LM-WD-B-W3-1	
	1.65	1450		2.16	4.31	4.78	3.01	.87	2.56	2.95	2.36	399,6	373,90		
	S	6	630	M 12 x 1,5	16,9	50,5	58,5	31,5	12	19	19	17	35	9,0	FI-RVVA-06SM-WD-B-W3-1
		.24	9137		.67	1.99	2.30	1.24	.47	.75	.75	.67	25,9	19,84	
8		630	M 14 x 1,5	18,9	50,5	58,5	31,5	12	19	19	19	55	7,0	FI-RVVA-08SM-WD-B-W3-1	
.31		9137		.74	1.99	2.30	1.24	.47	.75	.75	.75	40,7	15,43		
10		630	M 16 x 1,5	21,9	57,5	66,5	38	12	22	24	22	70	15,6	FI-RVVA-10SM-WD-B-W3-1	
.39		9137		.86	2.26	2.62	1.49	.47	.87	.94	.87	51,8	34,39		
12		630	M 18 x 1,5	23,9	60,5	69,5	41	12	24	27	24	90	15,4	FI-RVVA-12SM-WD-B-W3-1	
.47		9137		.94	2.38	2.74	1.61	.47	.94	1.06	.94	66,6	33,95		
14		630	M 20 x 1,5	25,9	66,5	76,5	44,5	14	27	32	27	125	27,2	FI-RVVA-14SM-WD-B-W3-1	
.55		9137		1.02	2.62	3.01	1.75	.55	1.06	1.26	1.06	92,5	59,97		
16		400	M 22 x 1,5	26,9	70,5	80,5	48	14	32	36	30	135	36,0	FI-RVVA-16SM-WD-B-W3-1	
.63		5801		1.06	2.78	3.17	1.89	.55	1.26	1.42	1.18	99,9	79,37		
20		400	M 27 x 2	31,9	78,5	89,5	52	16	41	46	36	180	50,3	FI-RVVA-20SM-WD-B-W3-1	
.79		5801		1.26	3.09	3.52	2.05	.63	1.61	1.81	1.42	133,2	110,89		
25		400	M 33 x 2	39,9	87	99	57	18	46	50	46	310	87,3	FI-RVVA-25SM-WD-B-W3-1	
.98		5801		1.57	3.43	3.90	2.24	.71	1.81	1.97	1.81	229,4	192,46		
30		250	M 42 x 2	49,9	99,5	112,5	66	20	55	60	50	450	113,2	FI-RVVA-30SM-WD-B-W3-1	
1.18		3625		1.96	3.92	4.43	2.59	.79	2.17	2.36	1.97	333,0	249,56		
38		250	M 48 x 2	54,9	110	125	72	22	65	70	60	540	197,3	FI-RVVA-38SM-WD-B-W3-1	
1.50		3625		2.16	4.33	4.92	2.83	.87	2.56	2.76	2.36	399,6	434,97		

<sup>1</sup> Approximate dimension in assembled condition.  
<sup>2</sup> Weight excluding cutting ring and union nut.  
<sup>3</sup> Standard scope of delivery: Valve body only.

Standard seal material is NBR (Buna-N®).  
Please note: Internal seals are made of FKM (Viton®).

In order to make sure that the valves will be suitable for your particular application, please contact STAUFF with details on media, operating pressure, pressure peaks, operating temperature and the expected frequency of valve actuations.

Male stud acc. to ISO 9974-2 (Type E)  
Port acc. to ISO 9974-1

Torque recommendations for Steel mating material.

Male threaded studs were designed for female threaded ports in components made of steel. For applications with components made of softer mating materials (e.g. Aluminium), the use of connectors with additionally rolled male threads is recommended.  
Please contact STAUFF prior to the assembly for further information.

Opening pressure tolerance ± 20%.

**Ordering Codes**

- \*FI-RVVA\*-10\*L\*M\*-WD\*-B\*-W3\*-1\*-MS
- \* Male Stud Check Valve (Flow from Stud End) **FI-RVVA**
- \* Outside Tube Diameter D1 (in mm) **-10**
- \* Series Light Series **L**  
Heavy Series **S**
- \* Thread Type Metric Parallel Thread **M**
- If required, please indicate special sizes, e.g. M12x1.5!
- \* Seal Type Profile Sealing Ring **-WD**
- \* Seal Material NBR (Buna-N®) **-B**  
FKM (Viton®) **-V**  
EPDM **-E**
- \* Material Code Steel, zinc/nickel-plated **-W3**
- Please contact STAUFF for alternative materials and surface finishings.
- \* Opening Pressure 1 bar / 14.5 PSI **1**
- Contact STAUFF for alternative opening pressures.
- \* Assembling / Kitting Fitting body only **—**  
Valve body supplied with cutting ring and union nut **-MS**  
Valve body supplied with soft-sealing cutting ring and union nut **-MSV**

**Connecting Parts**

-  Cutting Ring  
Type **FI-DS** Page 28
-  Soft-Sealing Cutting Ring  
Type **FI-WDDS** Page 29
-  Support Sleeve  
Type **FI-VH** Page 31
-  STAUFF Form EVO Sealing Ring  
Type **FI-FD** Page 32
-  Union Nut  
Type **FI-M** Page 33
-  37° Flared Tube Fitting Set  
Type **FI-AB** Page 37

**Spare Parts / Accessories**

-  Profile Sealing Ring  
Type **WDG** Page 238



**Male Stud Check Valve**  
**High-Pressure Version**  
**Type FI-RVZ-...-R-WD • Series L / S**

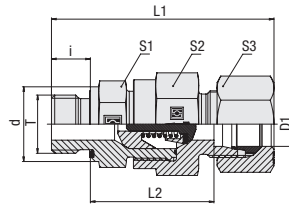

Flow Direction: B > A (to Stud End)  
 Standard Opening Pressure: 1 bar / 14.5 PSI

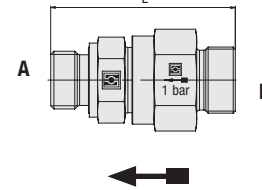

**Ordering Codes**

**\*FI-RVZ\*-10\*L\*R\*-WD\*-B\*-W3\*-1\*-MS**

- \* Male Stud Check Valve (Flow to Stud End) **FI-RVZ**
- \* Outside Tube Diameter D1 (in mm) **-10**
- \* Series Light Series **L**  
Heavy Series **S**
- \* Thread Type Whitworth Parallel Pipe Thread (BSPP) **R**
- If required, please indicate special sizes, e.g. R1/8!
- \* Seal Type Profile Sealing Ring **-WD**
- \* Seal Material NBR (Buna-N®) **-B**  
FKM (Viton®) **-V**  
EPDM **-E**
- \* Material Code Steel, zinc/nickel-plated **-W3**
- Please contact STAUFF for alternative materials and surface finishings.
- \* Opening Pressure 1 bar / 14.5 PSI **1**
- Contact STAUFF for alternative opening pressures.
- \* Assembling / Kitting Valve body only **—**
- Valve body supplied with cutting ring and union nut **-MS**
- Valve body supplied with soft-sealing cutting ring and union nut **-MSV**

**Connecting Parts**

- Cutting Ring Type **FI-DS** Page 28
- Soft-Sealing Cutting Ring Type **FI-WDDS** Page 29
- Support Sleeve Type **FI-VH** Page 31
- STAUFF Form EVO Sealing Ring Type **FI-FD** Page 32
- Union Nut Type **FI-M** Page 33
- 37° Flared Tube Fitting Set Type **FI-AB** Page 37

**Spare Parts / Accessories**

- Profile Sealing Ring Type **WDG** Page 238

**Whitworth Parallel Pipe Thread (BSPP)**

**Profile Sealing Ring**

Series	Tube OD (mm/in)	PN (bar/PSI)	Dimensions (mm/in)										Torque (N-m/ft-lb)	Weight (kg/lbs) ca.	Ordering Codes <sup>3</sup>
			Thread	T	d	L	L1 <sup>1</sup>	L2	i	S1	S2	S3			
L	6	400	G 1/8	13,9	51	59	36	8	22	27	14	18	12,07	FI-RVZ-06LR-WD-B-W3-1	
	.24	5800	G 1/8	.55	2.01	2.32	1.42	.31	.87	1.06	.55	13.3	26.55	FI-RVZ-06LR-WD-B-W3-1	
	8	400	G 1/4	18,9	55	63	36	12	22	27	17	35	12,56	FI-RVZ-08LR-WD-B-W3-1	
	.31	5800	G 1/4	.74	2.17	2.48	1.42	.47	.87	1.06	.67	25.8	27.63	FI-RVZ-08LR-WD-B-W3-1	
	10	400	G 1/4	18,9	53	61	34	12	22	27	19	35	11,38	FI-RVZ-10LR-WD-B-W3-1	
	.39	5800	G 1/4	.74	2.09	2.40	1.34	.47	.87	1.06	.75	25.8	25.04	FI-RVZ-10LR-WD-B-W3-1	
	12	400	G 3/8	21,9	58	66	39	12	22	27	22	70	13,64	FI-RVZ-12LR-WD-B-W3-1	
	.47	5800	G 3/8	.86	2.28	2.60	1.54	.47	.87	1.06	.87	51.8	30.00	FI-RVZ-12LR-WD-B-W3-1	
	15	400	G 1/2	26,9	62	70	41	14	27	32	27	90	19,15	FI-RVZ-15LR-WD-B-W3-1	
	.59	5800	G 1/2	1.06	2.44	2.76	1.61	.55	1.06	1.26	1.06	66.6	42.12	FI-RVZ-15LR-WD-B-W3-1	
	18	400	G 1/2	26,9	67	76	45,5	14	27	32	32	90	22,67	FI-RVZ-18LR-WD-B-W3-1	
	.71	5800	G 1/2	1.06	2.64	2.99	1.79	.55	1.06	1.26	1.26	66.6	49.88	FI-RVZ-18LR-WD-B-W3-1	
	22	250	G 3/4	31,9	77	86	53,5	16	46	41	36	180	45,69	FI-RVZ-22LR-WD-B-W3-1	
	.87	3625	G 3/4	1.26	3.03	3.39	2.11	.63	1.81	1.61	1.42	133.2	100.53	FI-RVZ-22LR-WD-B-W3-1	
	28	250	G 1	39,9	80	89	54,5	18	46	41	41	310	52,60	FI-RVZ-28LR-WD-B-W3-1	
	1.10	3625	G 1	1.57	3.15	3.50	2.15	.71	1.81	1.61	1.61	229.4	115.72	FI-RVZ-28LR-WD-B-W3-1	
	35	250	G 1 1/4	49,9	97,5	108,5	67	20	60	70	50	450	130,70	FI-RVZ-35LR-WD-B-W3-1	
	1.38	3625	G 1 1/4	1.96	3.84	4.27	2.64	.79	2.36	2.76	1.97	333.0	287.54	FI-RVZ-35LR-WD-B-W3-1	
42	250	G 1 1/2	54,9	97,5	109,5	64,5	22	60	70	60	540	137,40	FI-RVZ-42LR-WD-B-W3-1		
1.65	3625	G 1 1/2	2.16	3.84	4.31	2.54	.87	2.36	2.76	2.36	399.6	302.28	FI-RVZ-42LR-WD-B-W3-1		
S	6	400	G 1/4	18,9	57	65	38	12	22	27	17	55	12,92	FI-RVZ-06SR-WD-B-W3-1	
	.24	5800	G 1/4	.74	2.24	2.56	1.50	.47	.87	1.06	.67	40.7	28.42	FI-RVZ-06SR-WD-B-W3-1	
	8	400	G 1/4	18,9	55	63	36	12	22	27	19	55	12,18	FI-RVZ-08SR-WD-B-W3-1	
	.31	5800	G 1/4	.74	2.17	2.48	1.42	.47	.87	1.06	.75	40.7	26.80	FI-RVZ-08SR-WD-B-W3-1	
	10	400	G 3/8	21,9	57	66	37,5	12	22	27	22	80	13,30	FI-RVZ-10SR-WD-B-W3-1	
	.39	5800	G 3/8	.86	2.24	2.60	1.48	.47	.87	1.06	.87	59.2	29.25	FI-RVZ-10SR-WD-B-W3-1	
	12	400	G 3/8	21,9	59	68	39,5	12	22	27	24	80	14,64	FI-RVZ-12SR-WD-B-W3-1	
	.47	5800	G 3/8	.86	2.32	2.68	1.56	.47	.87	1.06	.94	59.2	32.20	FI-RVZ-12SR-WD-B-W3-1	
	14	400	G 1/2	26,9	64	74	42	14	27	32	27	115	20,23	FI-RVZ-14SR-WD-B-W3-1	
	.55	5800	G 1/2	1.06	2.52	2.91	1.65	.55	1.06	1.26	1.06	85.1	44.50	FI-RVZ-14SR-WD-B-W3-1	
	16	400	G 1/2	26,9	67	77	44,5	14	27	32	30	115	21,61	FI-RVZ-16SR-WD-B-W3-1	
	.63	5800	G 1/2	1.06	2.64	3.03	1.75	.55	1.06	1.26	1.18	85.1	47.55	FI-RVZ-16SR-WD-B-W3-1	
	20	400	G 3/4	31,9	79,5	90,5	53	16	46	41	36	180	46,63	FI-RVZ-20SR-WD-B-W3-1	
	.79	5800	G 3/4	1.26	3.13	3.56	2.09	.63	1.81	1.61	1.42	133.2	102.59	FI-RVZ-20SR-WD-B-W3-1	
	25	250	G 1	39,9	83	95	53	18	46	41	46	310	53,10	FI-RVZ-25SR-WD-B-W3-1	
	.98	3625	G 1	1.57	3.27	3.74	2.09	.71	1.81	1.61	1.81	229.4	116.82	FI-RVZ-25SR-WD-B-W3-1	
	30	250	G 1 1/4	49,9	94	107	60,5	20	50	55	50	450	85,80	FI-RVZ-30SR-WD-B-W3-1	
	1.18	3625	G 1 1/4	1.96	3.70	4.21	2.38	.79	1.97	2.17	1.97	333.0	188.76	FI-RVZ-30SR-WD-B-W3-1	
38	250	G 1 1/2	54,9	103,5	118,5	65,5	22	60	70	60	540	143,40	FI-RVZ-38SR-WD-B-W3-1		
1.50	3625	G 1 1/2	2.16	4.07	4.67	2.58	.87	2.36	2.76	2.36	399.6	315.48	FI-RVZ-38SR-WD-B-W3-1		

<sup>1</sup> Approximate dimension in assembled condition.  
<sup>2</sup> Weight excluding cutting ring and union nut.  
<sup>3</sup> Standard scope of delivery: Valve body only.

Male stud acc. to ISO 1179-2 (Type E)  
 Port acc. to ISO 1179-1

Torque recommendations for Steel mating material.

Standard seal material is NBR (Buna-N®).  
 Please note: Internal seals are made of FKM (Viton®).

Male threaded studs were designed for female threaded ports in components made of steel. For applications with components made of softer mating materials (e.g. Aluminium), the use of connectors with additionally rolled male threads is recommended.  
 Please contact STAUFF prior to the assembly for further information.

In order to make sure that the valves will be suitable for your particular application, please contact STAUFF with details on media, operating pressure, pressure peaks, operating temperature and the expected frequency of valve actuations.

Opening pressure tolerance ± 20%.



## Male Stud Check Valve High-Pressure Version Type FI-RVZ-...-M-WD • Series L / S

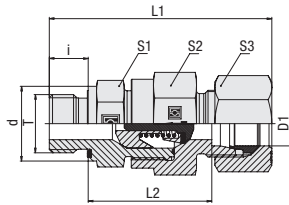

Flow Direction: B > A (to Stud End)  
Standard Opening Pressure: 1 bar / 14.5 PSI

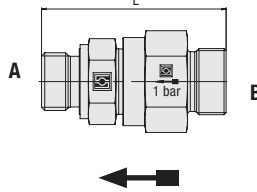

### Profile Sealing Ring

### Metric Parallel Thread

Series	Tube OD (mm/in)	PN (bar/PSI)	Dimensions (mm/in)										Torque (N·m/ft·lb)	Weight (kg/lbs) CA.	Ordering Codes <sup>3</sup>
			Thread	T	d	L	L <sup>1</sup>	L <sup>2</sup>	i	S1	S2	S3			
L	6	400	M 10 x 1		13,9	51	59	36	8	22	27	14	18	12,20	FI-RVZ-06LM-WD-B-W3-1
	.24	5800		.55	2.01	2.32	1.42	.31	.87	1.06	.55	13.3	26.84		
	8	400	M 12 x 1,5		16,9	55	63	36	12	22	27	17	25	12,31	FI-RVZ-08LM-WD-B-W3-1
	.31	5800		.67	2.17	2.48	1.42	.47	.87	1.06	.67	18.5	27.08		
	10	400	M 14 x 1,5		18,9	53	61	34	12	22	27	19	45	11,40	FI-RVZ-10LM-WD-B-W3-1
	.39	5800		.74	2.09	2.40	1.34	.47	.87	1.06	.75	33.3	25.08		
	12	400	M 16 x 1,5		21,9	58	66	39	12	22	27	22	55	14,02	FI-RVZ-12LM-WD-B-W3-1
	.47	5800		.86	2.28	2.60	1.54	.47	.87	1.06	.87	40.7	30.84		
	15	400	M 18 x 1,5		23,9	60	68	41	12	27	32	27	70	19,06	FI-RVZ-15LM-WD-B-W3-1
	.59	5800		.94	2.36	2.68	1.61	.47	1.06	1.26	1.06	51.8	41.92		
	18	400	M 22 x 1,5		26,9	67	76	45,5	14	27	32	32	125	10,27	FI-RVZ-18LM-WD-B-W3-1
	.71	5800		1.06	2.64	2.99	1.79	.55	1.06	1.26	1.26	92.5	22.59		
	22	250	M 26 x 1,5		31,9	78	87	54,5	16	46	41	36	180	46,73	FI-RVZ-22LM-WD-B-W3-1
	.87	3625		1.26	3.07	3.43	2.15	.63	1.81	1.61	1.42	133.2	102.81		
	28	250	M 33 x 2		39,9	80	89	54,5	18	46	41	41	310	52,70	FI-RVZ-28LM-WD-B-W3-1
	1.10	3625		1.57	3.15	3.50	2.15	.71	1.81	1.61	1.61	229.4	115.94		
	35	250	M 42 x 2		49,9	97,5	108,5	67	20	60	70	50	450	132,30	FI-RVZ-35LM-WD-B-W3-1
	1.38	3625		1.96	3.84	4.27	2.64	.79	2.36	2.76	1.97	333.0	291.06		
	42	250	M 48 x 2		54,9	97,5	109,5	64,5	22	60	70	60	540	137,70	FI-RVZ-42LM-WD-B-W3-1
	1.65	3625		2.16	3.84	4.31	2.54	.87	2.36	2.76	2.36	399.6	302.94		
S	6	400	M 12 x 1,5		16,9	57	65	38	12	22	27	17	35	12,66	FI-RVZ-06SM-WD-B-W3-1
	.24	5800		.67	2.24	2.56	1.50	.47	.87	1.06	.67	25.9	27.85		
	8	400	M 14 x 1,5		18,9	55	63	36	12	22	27	19	55	12,21	FI-RVZ-08SM-WD-B-W3-1
	.31	5800		.74	2.17	2.48	1.42	.47	.87	1.06	.75	40.7	26.87		
	10	400	M 16 x 1,5		21,9	57	66	37,5	12	22	27	22	70	6,64	FI-RVZ-10SM-WD-B-W3-1
	.39	5800		.86	2.24	2.60	1.48	.47	.87	1.06	.87	51.8	14.61		
	12	400	M 18 x 1,5		23,9	59	68	39,5	12	24	27	24	90	15,58	FI-RVZ-12SM-WD-B-W3-1
	.47	5800		.94	2.32	2.68	1.56	.47	.94	1.06	.94	66.6	34.28		
	14	400	M 20 x 1,5		25,9	64	74	42	14	27	32	27	125	19,98	FI-RVZ-14SM-WD-B-W3-1
	.55	5800		1.02	2.52	2.91	1.65	.55	1.06	1.26	1.06	92.5	43.96		
	16	400	M 22 x 1,5		26,9	67	77	44,5	14	27	32	30	135	21,94	FI-RVZ-16SM-WD-B-W3-1
	.63	5800		1.06	2.64	3.03	1.75	.55	1.06	1.26	1.18	99.9	48.26		
	20	400	M 27 x 2		31,9	78	89	51,5	16	46	41	36	180	53,51	FI-RVZ-20SM-WD-B-W3-1
	.79	5800		1.26	3.07	3.50	2.03	.63	1.81	1.61	1.42	133.2	117.72		
	25	250	M 33 x 2		39,9	83	95	53	18	46	41	46	310	53,10	FI-RVZ-25SM-WD-B-W3-1
	.98	3625		1.57	3.27	3.74	2.09	.71	1.81	1.61	1.81	229.4	116.82		
	30	250	M 42 x 2		49,9	94	107	60,5	20	50	55	50	450	86,00	FI-RVZ-30SM-WD-B-W3-1
	1.18	3625		1.96	3.70	4.21	2.38	.79	1.97	2.17	1.97	333.0	189.20		
	38	250	M 48 x 2		54,9	103,5	118,5	65,5	22	60	70	60	540	143,90	FI-RVZ-38SM-WD-B-W3-1
	1.50	3625		2.16	4.07	4.67	2.58	.87	2.36	2.76	2.36	399.6	316.58		

<sup>1</sup> Approximate dimension in assembled condition.  
<sup>2</sup> Weight excluding cutting ring and union nut.  
<sup>3</sup> Standard scope of delivery: Valve body only.

Standard seal material is NBR (Buna-N®).  
Please note: Internal seals are made of FKM (Viton®).

In order to make sure that the valves will be suitable for your particular application, please contact STAUFF with details on media, operating pressure, pressure peaks, operating temperature and the expected frequency of valve actuations.

Male stud acc. to ISO 9974-2 (Type E)  
Port acc. to ISO 9974-1

Torque recommendations for Steel mating material.

Male threaded studs were designed for female threaded ports in components made of steel. For applications with components made of softer mating materials (e.g. Aluminium), the use of connectors with additionally rolled male threads is recommended.  
Please contact STAUFF prior to the assembly for further information.

Opening pressure tolerance ± 20%.

### Ordering Codes

**\*FI-RVZ\*-10\*L\*M\*-WD\*-B\*-W3\*-1\*-MS**

- \* Male Stud Check Valve (Flow to Stud End) **FI-RVZ**
- \* Outside Tube Diameter D1 (in mm) **-10**
- \* Series Light Series **L**  
Heavy Series **S**
- \* Thread Type Metric Parallel Thread **M**
- If required, please indicate special sizes, e.g. M12x1.5!
- \* Seal Type Profile Sealing Ring **-WD**
- \* Seal Material NBR (Buna-N®) **-B**  
FKM (Viton®) **-V**  
EPDM **-E**
- \* Material Code Steel, zinc/nickel-plated **-W3**

Please contact STAUFF for alternative materials and surface finishings.

\* Opening Pressure 1 bar / 14.5 PSI **1**

Contact STAUFF for alternative opening pressures.

- \* Assembling / Kitting Valve body only **—**
- Valve body supplied with cutting ring and union nut **-MS**
- Valve body supplied with soft-sealing cutting ring and union nut **-MSV**

### Connecting Parts

- Cutting Ring  
Type **FI-DS** Page 28
- Soft-Sealing Cutting Ring  
Type **FI-WDDS** Page 29
- Support Sleeve  
Type **FI-VH** Page 31
- STAUFF Form EVO Sealing Ring  
Type **FI-FD** Page 32
- Union Nut  
Type **FI-M** Page 33
- 37° Flared Tube Fitting Set  
Type **FI-AB** Page 37

### Spare Parts / Accessories

- Profile Sealing Ring  
Type **WDG** Page 238



**Male Stud Check Valve**  
**Standard Version**  
**Type FI-RVZA-...-R-WD • Series L / S**

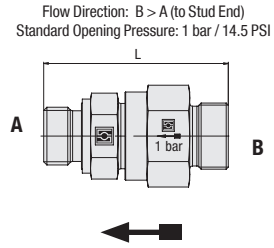
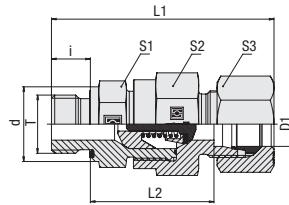

**Ordering Codes**

**\*FI-RVZA\*-10\*L\*R\*-WD\*-B\*-W3\*-1\*-MS**

- \* Male Stud Check Valve (Flow to Stud End) **FI-RVZA**
- \* Outside Tube Diameter D1 (in mm) **-10**
- \* Series Light Series **L**  
Heavy Series **S**
- \* Thread Type Whitworth Parallel Pipe Thread (BSPP) **R**
- If required, please indicate special sizes, e.g. R1/8!
- \* Seal Type Profile Sealing Ring **-WD**
- \* Seal Material NBR (Buna-N®) **-B**  
FKM (Viton®) **-V**  
EPDM **-E**
- \* Material Code Steel, zinc/nickel-plated **-W3**
- Please contact STAUFF for alternative materials and surface finishings.
- \* Opening Pressure 1 bar / 14.5 PSI **1**
- Contact STAUFF for alternative opening pressures.
- \* Assembling / Kitting Valve body only **—**
- Valve body supplied with cutting ring and union nut **-MS**
- Valve body supplied with soft-sealing cutting ring and union nut **-MSV**

**Connecting Parts**

	Cutting Ring Type <b>FI-DS</b>	Page 28
	Soft-Sealing Cutting Ring Type <b>FI-WDDS</b>	Page 29
	Support Sleeve Type <b>FI-VH</b>	Page 31
	STAUFF Form EVO Sealing Ring Type <b>FI-FD</b>	Page 32
	Union Nut Type <b>FI-M</b>	Page 33
	37° Flared Tube Fitting Set Type <b>FI-AB</b>	Page 37

**Spare Parts / Accessories**

	Profile Sealing Ring Type <b>WDG</b>	Page 238
--	---	----------

**Whitworth Parallel Pipe Thread (BSPP)**

**Profile Sealing Ring**

Series	Tube OD (mm/in)	PB (bar/PSI)	Dimensions (mm/in)										Torque (N·m/ft·lb)	Weight (kg/lbs) ca.	Ordering Codes <sup>3</sup>
			D1	Thread	T	d	L	L1 <sup>1</sup>	L2	i	S1	S2			
L	6	250	G 1/8	13,9	43	51	28	8	17	17	14	18	4,5	FI-RVZA-06LR-WD-B-W3-1	
	.24	3625	G 1/8	.55	1.69	2.01	1.10	.31	.67	.67	.55	13.3	9.92	FI-RVZA-06LR-WD-B-W3-1	
	8	250	G 1/4	18,9	47,5	55,5	28,5	12	19	19	17	35	5,8	FI-RVZA-08LR-WD-B-W3-1	
	.31	3625	G 1/4	.74	1.87	2.19	1.12	.47	.75	.75	.67	25.8	12.79	FI-RVZA-08LR-WD-B-W3-1	
	10	250	G 1/4	18,9	59	67	40	12	22	24	19	35	10,6	FI-RVZA-10LR-WD-B-W3-1	
	.39	3625	G 1/4	.74	2.32	2.64	1.57	.47	.87	.94	.75	25.8	23.37	FI-RVZA-10LR-WD-B-W3-1	
	12	250	G 3/8	21,9	60,5	68,5	41,5	12	27	30	22	70	16,8	FI-RVZA-12LR-WD-B-W3-1	
	.47	3625	G 3/8	.86	2.38	2.70	1.63	.47	1.06	1.18	.87	51.8	37.04	FI-RVZA-12LR-WD-B-W3-1	
	15	250	G 1/2	26,9	65	73	44	14	30	32	27	90	20,8	FI-RVZA-15LR-WD-B-W3-1	
	.59	3625	G 1/2	1.06	2.56	2.87	1.73	.55	1.18	1.26	1.06	66.6	45.86	FI-RVZA-15LR-WD-B-W3-1	
	18	160	G 1/2	26,9	69,5	78,5	48	14	36	36	32	90	28,0	FI-RVZA-18LR-WD-B-W3-1	
	.71	2320	G 1/2	1.06	2.74	3.09	1.89	.55	1.42	1.42	1.26	66.6	61.73	FI-RVZA-18LR-WD-B-W3-1	
	22	160	G 3/4	31,9	80,5	89,5	57	16	41	46	36	180	49,4	FI-RVZA-22LR-WD-B-W3-1	
	.87	2320	G 3/4	1.26	3.17	3.52	2.24	.63	1.61	1.81	1.42	133.2	108.91	FI-RVZA-22LR-WD-B-W3-1	
	28	100	G 1	39,9	92,5	101,5	67	18	50	55	41	310	81,9	FI-RVZA-28LR-WD-B-W3-1	
	1.10	1450	G 1	1.57	3.64	4.00	2.64	.71	1.97	2.17	1.61	229.4	180.56	FI-RVZA-28LR-WD-B-W3-1	
35	100	G 1 1/4	49,9	102	113	71,5	20	60	65	50	450	121,7	FI-RVZA-35LR-WD-B-W3-1		
1.38	1450	G 1 1/4	1.96	4.02	4.45	2.81	.79	2.36	2.56	1.97	333.0	268.30	FI-RVZA-35LR-WD-B-W3-1		
42	100	G 1 1/2	54,9	108,5	120,5	75,5	22	65	75	60	540	167,2	FI-RVZA-42LR-WD-B-W3-1		
1.65	1450	G 1 1/2	2.16	4.27	4.74	2.97	.87	2.56	2.95	2.36	399.6	368.61	FI-RVZA-42LR-WD-B-W3-1		
S	6	630	G 1/4	18,9	50,5	58,5	31,5	12	19	19	17	55	7,0	FI-RVZA-06SR-WD-B-W3-1	
	.24	9137	G 1/4	.74	1.99	2.30	1.24	.47	.75	.75	.67	40.7	15.43	FI-RVZA-06SR-WD-B-W3-1	
	8	630	G 1/4	18,9	50,5	58,5	31,5	12	19	19	19	55	6,9	FI-RVZA-08SR-WD-B-W3-1	
	.31	9137	G 1/4	.74	1.99	2.30	1.24	.47	.75	.75	.75	40.7	15.21	FI-RVZA-08SR-WD-B-W3-1	
	10	630	G 3/8	21,9	57,5	66,5	38	12	22	24	22	80	12,0	FI-RVZA-10SR-WD-B-W3-1	
	.39	9137	G 3/8	.86	2.26	2.62	1.49	.47	.87	.94	.87	59.2	26.46	FI-RVZA-10SR-WD-B-W3-1	
	12	630	G 3/8	21,9	60,5	69,5	41	12	24	27	24	80	15,0	FI-RVZA-12SR-WD-B-W3-1	
	.47	9137	G 3/8	.86	2.38	2.74	1.61	.47	.94	1.06	.94	59.2	33.07	FI-RVZA-12SR-WD-B-W3-1	
	14	630	G 1/2	26,9	65,5	75,5	43,5	14	27	32	27	115	21,6	FI-RVZA-14SR-WD-B-W3-1	
	.55	9137	G 1/2	1.06	2.58	2.97	1.71	.55	1.06	1.26	1.06	85.1	47.62	FI-RVZA-14SR-WD-B-W3-1	
	16	400	G 1/2	26,9	70,5	80,5	48	14	32	36	30	115	28,0	FI-RVZA-16SR-WD-B-W3-1	
	.63	5801	G 1/2	1.06	2.76	3.17	1.89	.55	1.26	1.42	1.18	85.1	61.72	FI-RVZA-16SR-WD-B-W3-1	
	20	400	G 3/4	31,9	78,5	89,5	52	16	41	46	36	180	50,7	FI-RVZA-20SR-WD-B-W3-1	
	.79	5801	G 3/4	1.26	3.09	3.52	2.05	.63	1.61	1.81	1.42	133.2	11.77	FI-RVZA-20SR-WD-B-W3-1	
	25	400	G 1	39,9	87	99	57	18	46	50	46	310	65,6	FI-RVZA-25SR-WD-B-W3-1	
	.98	5801	G 1	1.57	3.43	3.90	2.24	.71	1.81	1.97	1.81	229.4	144.62	FI-RVZA-25SR-WD-B-W3-1	
30	250	G 1 1/4	49,9	99,5	112,5	66	20	55	60	50	450	108,5	FI-RVZA-30SR-WD-B-W3-1		
1.18	3625	G 1 1/4	1.96	3.92	4.43	2.59	.79	2.17	2.36	1.97	333.0	239.20	FI-RVZA-30SR-WD-B-W3-1		
38	250	G 1 1/2	54,9	110,5	125,5	72,5	22	65	70	60	540	161,8	FI-RVZA-38SR-WD-B-W3-1		
1.50	3625	G 1 1/2	2.16	4.35	4.94	2.85	.87	2.56	2.76	2.36	399.6	356.71	FI-RVZA-38SR-WD-B-W3-1		

<sup>1</sup> Approximate dimension in assembled condition.  
<sup>2</sup> Weight excluding cutting ring and union nut.  
<sup>3</sup> Standard scope of delivery: Valve body only.

Standard seal material is NBR (Buna-N®).  
 Please note: Internal seals are made of FKM (Viton®).

In order to make sure that the valves will be suitable for your particular application, please contact STAUFF with details on media, operating pressure, pressure peaks, operating temperature and the expected frequency of valve actuations.

Male stud acc. to ISO 1179-2 (Type E)  
 Port acc. to ISO 1179-1

Torque recommendations for Steel mating material.

Male threaded studs were designed for female threaded ports in components made of steel. For applications with components made of softer mating materials (e.g. Aluminium), the use of connectors with additionally rolled male threads is recommended.  
 Please contact STAUFF prior to the assembly for further information.

Opening pressure tolerance ± 20%.





### Male Stud Check Valve Standard Version Type FI-RVZA-...-M-WD • Series L / S

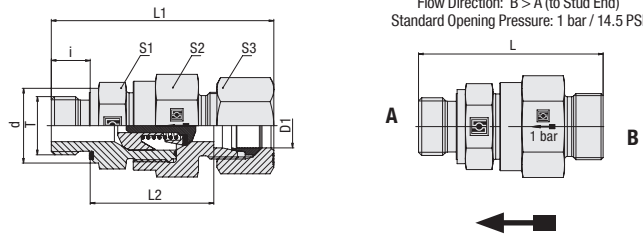

Profile Sealing Ring

Metric Parallel Thread

Series	Tube OD (mm/in)	PB (bar/PSI)	Dimensions (mm/in)										Torque (N·m/ft·lb)	Weight (kg/lbs) CA.	Ordering Codes <sup>3</sup>
			Thread	T	d	L	L <sup>1</sup>	L <sup>2</sup>	i	S1	S2	S3			
L	6	250	M 10 x 1	13,9	43	51	28	8	17	17	14	18	5,7	FI-RVZA-06LM-WD-B-W3-1	
	.24	3625		.55	1.69	2.01	1.10	.31	.67	.67	.55	13.3	12.57		
	8	250	M 12 x 1,5	16,9	47,5	55,5	28,5	12	19	19	17	25	5,5	FI-RVZA-08LM-WD-B-W3-1	
	.31	3625		.67	1.87	2.19	1.12	.47	.75	.75	.67	18.5	12.13		
	10	250	M 14 x 1,5	18,9	57,5	65,5	38,5	12	22	24	19	45	10,3	FI-RVZA-10LM-WD-B-W3-1	
	.39	3625		.74	2.26	2.58	1.53	.47	.87	.94	.75	33.3	22.71		
	12	250	M 16 x 1,5	21,9	60	68	41	12	27	30	22	55	16,5	FI-RVZA-12LM-WD-B-W3-1	
	.47	3625		.86	2.36	2.68	1.61	.47	1.06	1.18	.87	40.7	36.38		
	15	250	M 18 x 1,5	23,9	63	71	44	12	30	32	27	70	19,9	FI-RVZA-15LM-WD-B-W3-1	
	.59	3625		.94	2.48	2.80	1.73	.47	1.18	1.26	1.06	51.8	43.87		
	18	160	M 22 x 1,5	26,9	69,5	78,5	48	14	36	36	32	125	28,3	FI-RVZA-18LM-WD-B-W3-1	
	.71	2320		1.06	2.74	3.09	1.89	.55	1.42	1.42	1.26	92.5	62.39		
	22	160	M 26 x 1,5	31,9	79,5	88,5	56	16	41	46	36	180	47,9	FI-RVZA-22LM-WD-B-W3-1	
	.87	2320		1.26	3.13	3.48	2.20	.63	1.61	1.81	1.42	133.2	105.60		
	28	100	M 33 x 2	39,9	91	100	65,5	18	50	55	41	310	79,4	FI-RVZA-28LM-WD-B-W3-1	
	1.10	1450		1.57	3.58	3.94	2.58	.71	1.97	2.17	1.61	229.4	175.05		
	35	100	M 42 x 2	49,9	102	113	71,5	20	60	65	50	450	125,8	FI-RVZA-35LM-WD-B-W3-1	
	1.38	1450		1.96	4.02	4.45	2.81	.79	2.36	2.56	1.97	333.0	277.34		
	42	100	M 48 x 2	54,9	108,5	120,5	75,5	22	65	75	60	540	194,0	FI-RVZA-42LM-WD-B-W3-1	
	1.65	1450		2.16	4.27	4.74	2.97	.87	2.56	2.95	2.36	399.6	427.69		
S	6	630	M 12 x 1,5	16,9	50,5	58,5	31,5	12	19	19	17	35	9,3	FI-RVZA-06SM-WD-B-W3-1	
	.24	9137		.67	1.99	2.30	1.24	.47	.75	.75	.67	25.9	20.50		
	8	630	M 14 x 1,5	18,9	50,5	58,5	31,5	12	19	19	19	55	9,2	FI-RVZA-08SM-WD-B-W3-1	
	.31	9137		.74	1.99	2.30	1.24	.47	.75	.75	.75	40.7	20.28		
	10	630	M 16 x 1,5	21,9	57,5	66,5	38	12	22	24	22	70	11,8	FI-RVZA-10SM-WD-B-W3-1	
	.39	9137		.86	2.26	2.62	1.49	.47	.87	.94	.87	51.8	26.01		
	12	630	M 18 x 1,5	23,9	60,5	69,5	41	12	24	27	24	90	18,9	FI-RVZA-12SM-WD-B-W3-1	
	.47	9137		.94	2.38	2.74	1.61	.47	.94	1.06	.94	66.6	41.67		
	14	630	M 20 x 1,5	25,9	65,5	75,5	43,5	14	27	32	27	125	27,9	FI-RVZA-14SM-WD-B-W3-1	
	.55	9137		1.02	2.58	2.97	1.71	.55	1.06	1.26	1.06	92.5	61.51		
	16	400	M 22 x 1,5	26,9	69	79	46,5	14	32	36	30	135	27,5	FI-RVZA-16SM-WD-B-W3-1	
	.63	5801		1.06	2.72	3.11	1.83	.55	1.26	1.42	1.18	99.9	60.63		
	20	400	M 27 x 2	31,9	78,5	89,5	52	16	41	46	36	180	50,3	FI-RVZA-20SM-WD-B-W3-1	
	.79	5801		1.26	3.09	3.52	2.05	.63	1.61	1.81	1.42	133.2	110.89		
	25	400	M 33 x 2	39,9	87	99	57	18	46	50	46	310	65,5	FI-RVZA-25SM-WD-B-W3-1	
	.98	5801		1.57	3.43	3.90	2.25	.71	1.81	1.97	1.81	229.4	144.40		
	30	250	M 42 x 2	49,9	99,5	112,5	66	20	55	60	50	450	133,8	FI-RVZA-30SM-WD-B-W3-1	
	1.18	3625		1.96	3.92	4.43	2.60	.79	2.17	2.36	1.97	333.0	294.98		
	38	250	M 48 x 2	54,9	110,5	125,5	72,5	22	65	70	60	540	196,9	FI-RVZA-38SM-WD-B-W3-1	
	1.50	3625		2.16	4.35	4.94	2.85	.87	2.56	2.76	2.36	399.6	374.56		

<sup>1</sup> Approximate dimension in assembled condition.  
<sup>2</sup> Weight excluding cutting ring and union nut.  
<sup>3</sup> Standard scope of delivery: Valve body only.

Standard seal material is NBR (Buna-N®).  
Please note: Internal seals are made of FKM (Viton®).

In order to make sure that the valves will be suitable for your particular application, please contact STAUFF with details on media, operating pressure, pressure peaks, operating temperature and the expected frequency of valve actuations.

Male stud acc. to ISO 9974-2 (Type E)  
Port acc. to ISO 9974-1

Torque recommendations for Steel mating material.

Male threaded studs were designed for female threaded ports in components made of steel. For applications with components made of softer mating materials (e.g. Aluminium), the use of connectors with additionally rolled male threads is recommended.  
Please contact STAUFF prior to the assembly for further information.

Opening pressure tolerance ± 20%.

#### Ordering Codes

- \*FI-RVZA\*-10\*L\*M\*-WD\*-B\*-W3\*-1\*-MS
- \* Male Stud Check Valve (Flow to Stud End) **FI-RVZA**
- \* Outside Tube Diameter D1 (in mm) **-10**
- \* Series **L** Light Series  
**S** Heavy Series
- \* Thread Type **M** Metric Parallel Thread
- If required, please indicate special sizes, e.g. M12x1.5!
- \* Seal Type **-WD** Profile Sealing Ring
- \* Seal Material **-B** NBR (Buna-N®)  
**-V** FKM (Viton®)  
**-E** EPDM
- \* Material Code **-W3** Steel, zinc/nickel-plated
- Please contact STAUFF for alternative materials and surface finishings.
- \* Opening Pressure **1** 1 bar / 14.5 PSI  
Contact STAUFF for alternative opening pressures.
- \* Assembling / Kitting **—** Valve body only  
**-MS** Valve body supplied with cutting ring and union nut  
**-MSV** Valve body supplied with soft-sealing cutting ring and union nut

#### Connecting Parts

- Cutting Ring  
Type **FI-DS** Page 28
- Soft-Sealing Cutting Ring  
Type **FI-WDDS** Page 29
- Support Sleeve  
Type **FI-VH** Page 31
- STAUFF Form EVO Sealing Ring  
Type **FI-FD** Page 32
- Union Nut  
Type **FI-M** Page 33
- 37° Flared Tube Fitting Set  
Type **FI-AB** Page 37

#### Spare Parts / Accessories

- Profile Sealing Ring  
Type **WDG** Page 238



**Female Stud Check Valve  
High-Pressure Version  
Type FI-RVI-...-R**



Standard Opening Pressure: 1 bar / 14.5 PSI

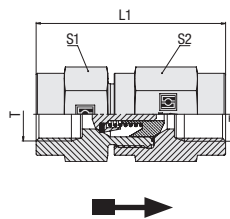

**Female Whitworth Parallel Pipe Thread (BSPP)**

**Ordering Codes**

**\*FI-RVI\*-R\*1/2\*-W3\*-1**

\* Female Stud Check Valve **FI-RVI**

\* Thread Type Female Whitworth Parallel Pipe Thread (BSPP) **R**

\* Thread Size acc. to dimension table **1/2**

Please always indicate thread sizes, e.g. 1/2!

\* Material Code Steel, zinc/nickel-plated **-W3**

Please contact STAUFF for alternative materials and surface finishings.

\* Opening Pressure 1 bar / 14.5 PSI **1**

Contact STAUFF for alternative opening pressures.

PN ( <sup>bar</sup> / <sub>PSI</sub> )	Dimensions ( <sup>mm</sup> / <sub>in</sub> )				Weight ( <sup>kg</sup> / <sub>lbs</sub> ) ca. per 100	Ordering Codes
	Thread T	L1	S1	S2		
400	G 1/8	53	22	27	17,72	FI-RVI-R1/8-W3-1
5800		2.09	.87	1.06	38.98	
400	G 1/4	63	22	27	18,60	FI-RVI-R1/4-W3-1
5800		2.48	.87	1.06	40.91	
400	G 3/8	62	24	27	17,69	FI-RVI-R3/8-W3-1
5800		2.44	.94	1.06	38.92	
315	G 1/2	73,5	32	32	34,03	FI-RVI-R1/2-W3-1
4568		2.89	1.26	1.26	74.87	
250	G 3/4	94,5	41	46	75,00	FI-RVI-R3/4-W3-1
3625		3.72	1.61	1.81	165.00	
250	G 1	99,5	46	46	84,34	FI-RVI-R1-W3-1
3625		3.92	1.81	1.81	185.56	
250	G 1 1/4	114,5	60	60	168,10	FI-RVI-R1-1/4-W3-1
3625		4.51	2.36	2.36	369.82	
250	G 1 1/2	118,5	65	70	210,90	FI-RVI-R1-1/2-W3-1
3625		4.67	2.56	2.76	463.98	

Please note: Internal seals are made of FKM (Viton®).

Opening pressure tolerance ± 20%.

In order to make sure that the valves will be suitable for your particular application, please contact STAUFF with details on media, operating pressure, pressure peaks, operating temperature and the expected frequency of valve actuations.

M



## Female Stud Check Valve Standard Version Type FI-RVIA-...-R

Standard Opening Pressure: 1 bar / 14.5 PSI

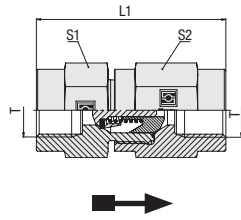

### Female Whitworth Parallel Pipe Thread (BSPP)

PB (bar/PSI)	Dimensions (mm/in)		S1	S2	Weight (kg/lbs) ca. per 100	Ordering Codes
	Thread T	L1				
250	G 1/8	50,5	19	19	10,4	FI-RVIA-R1/8-W3-1
3625		1.99	.75	.75	22.93	
250	G 1/4	55	19	19	11,7	FI-RVIA-R1/4-W3-1
3625		2.16	.75	.75	25.79	
250	G 3/8	68,5	24	27	21,0	FI-RVIA-R3/8-W3-1
3625		2.70	.94	1.06	46.30	
250	G 1/2	74	32	36	35,5	FI-RVIA-R1/2-W3-1
3625		2.91	1.26	1.42	78.26	
160	G 3/4	84	41	46	80,7	FI-RVIA-R3/4-W3-1
2320		3.31	1.61	1.81	177.91	
160	G 1	96,5	46	50	89,2	FI-RVIA-R1-W3-1
2320		3.80	1.81	1.97	196.65	
100	G 1 1/4	110	60	60	189,0	FI-RVIA-R1-1/4-W3-1
1450		4.33	2.36	2.36	416.67	
100	G 1 1/2	119	65	70	237,6	FI-RVIA-R1-1/2-W3-1
1450		4.69	2.56	2.76	523,82	

### Ordering Codes

**\*FI-RVIA\*-R\*1/2\*-W3\*-1**

* Female Stud Check Valve		<b>FI-RVIA</b>
* Thread Type	Female Whitworth Parallel Pipe Thread (BSPP)	<b>R</b>
* Thread Size	acc. to dimension table	<b>1/2</b>
Please always indicate thread sizes, e.g. 1/2!		
* Material Code	Steel, zinc/nickel-plated	<b>-W3</b>
Please contact STAUFF for alternative materials and surface finishings.		
* Opening Pressure	1 bar / 14.5 PSI	<b>1</b>
Contact STAUFF for alternative opening pressures.		

Please note: Internal seals are made of FKM (Viton®).

Opening pressure tolerance  $\pm$  20%.

In order to make sure that the valves will be suitable for your particular application, please contact STAUFF with details on media, operating pressure, pressure peaks, operating temperature and the expected frequency of valve actuations.



### Check Valve Installation Kit Type FI-VES • Design A

Standard Opening Pressure: 1 bar / 14.5 PSI

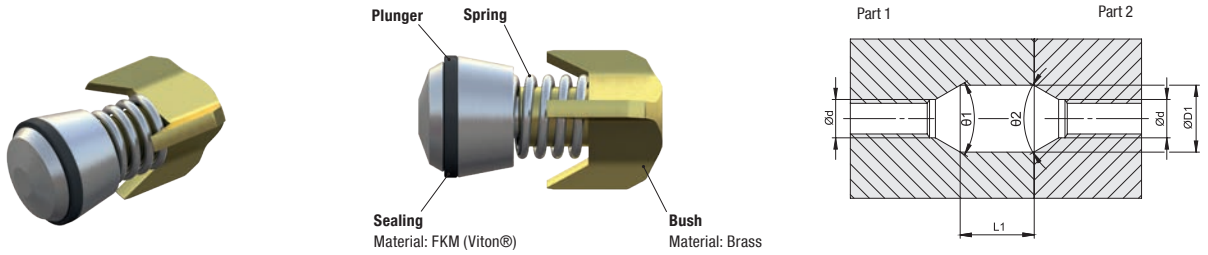

Tube OD (mm/in)		Dimensions (mm/in)						Ordering Codes	
		d	D1	L1	Ø1	Ø2			
6	8	10	12	7,5	13,1	14,5	60	60	FI-VES-NW06-1
.24	.31	.39	.47	.30	.52	.57			
14	15	16	18	11,5	17,6	17	60	60	FI-VES-NW10-1
.55	.59	.63	.71	.45	.69	.67			

### Check Valve Installation Kit Type FI-VES • Design B

Standard Opening Pressure: 1 bar / 14.5 PSI

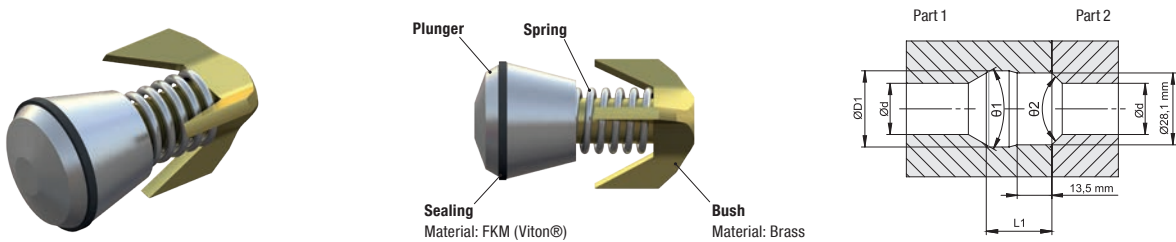

Tube OD (mm/in)		Dimensions (mm/in)						Ordering Codes	
		d	D1	L1	Ø1	Ø2			
20	22	25	28	20	29,8	25,7	60	90	FI-VES-NW16-1
.79	.87	.98	1.10	.79	1.17	1.01			

### Check Valve Installation Kit Type FI-VES • Design C

Standard Opening Pressure: 1 bar / 14.5 PSI

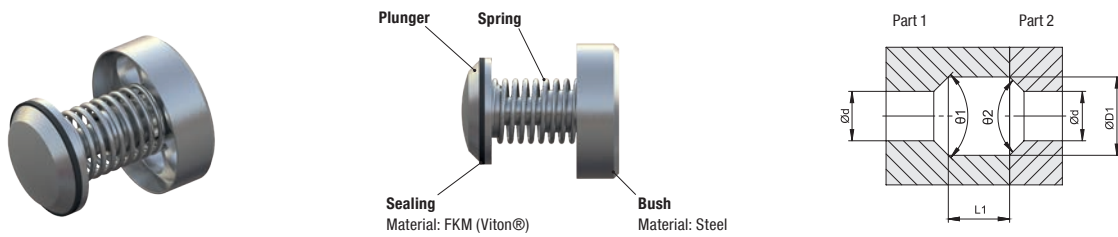

Tube OD (mm/in)		Dimensions (mm/in)						Ordering Codes	
		d	D1	L1	Ø1	Ø2			
30		24	38	33	90	90	FI-VES-NW25-1		
1.18		.94	1.50	1.30					
35	38	42	29	46	36	90	90	FI-VES-NW32-1	
1.38	1.50	1.65	1.14	1.81	1.42				

M



## Alternating Valve Type FI-WV • Series L / S

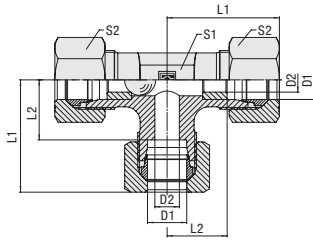

Flow Directions:  
A > C (B closed) or B > C (A closed)

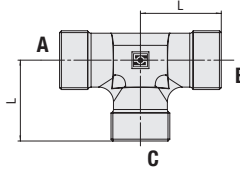

Recommended Installation Position



Series	Tube OD	PB	Dimensions					Weight (kg/lbs) ca. per 100	Ordering Codes <sup>3</sup>	
	(mm/in)	(bar/PSI)	(mm/in)	L	L1 <sup>1</sup>	L2	S1			S2
L	8	250	4	21	29	14	14	17	5,50	FI-WV-08L-W3
	.31	3625	.16	.83	1.14	.55	.55	.67	12.09	
	10	250	6	22	30	15	17	19	7,30	FI-WV-10L-W3
	.39	3625	.24	.87	1.18	.59	.67	.75	16.07	
	12	250	8	24	32	17	19	22	10,27	FI-WV-12L-W3
	.47	3625	.31	.94	1.26	.67	.75	.87	22.59	
15	250	9	28	36	21	19	27	10,95	FI-WV-15L-W3	
.59	3625	.35	1.10	1.42	.83	.75	1.06	24.09		
S	6	630	4	23	31	16	14	17	7,04	FI-WV-06S-W3
	.24	9135	.16	.91	1.22	.63	.55	.67	15.49	
	8	630	4	24	32	17	17	19	9,49	FI-WV-08S-W3
	.31	9135	.16	.94	1.26	.67	.67	.75	20.87	
	10	630	6	25	34	17,5	19	22	12,41	FI-WV-10S-W3
	.39	9135	.24	.98	1.34	.69	.75	.87	27.31	
	12	630	8	29	38	21,5	22	24	17,10	FI-WV-12S-W3
	.47	9135	.31	1.14	1.50	.85	.87	.94	37.62	
	16	400	10	33	43	24,5	24	30	19,60	FI-WV-16S-W3
	.63	5800	.39	1.30	1.69	.96	.94	1.18	43.13	

### Ordering Codes

**\*FI-WV\*-10\*L\*-W3\*-MS**

* Alternating Valve	<b>FI-WV</b>
* Outside Tube Diameter D1 (in mm)	<b>-10</b>
* Series	Light Series <b>L</b> Heavy Series <b>S</b>
* Material Code	Steel, zinc/nickel-plated <b>-W3</b>
Please contact STAUFF for alternative materials and surface finishings.	
* Assembling / Kitting	Valve body only <b>—</b>
	Valve body supplied with cutting rings and union nuts <b>-MS</b>
	Valve body supplied with soft-sealing cutting rings and union nuts <b>-MSV</b>

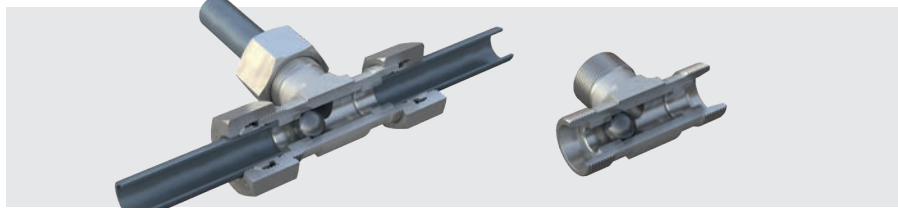

<sup>1</sup> Approximate dimension in assembled condition.

<sup>2</sup> Weight excluding cutting rings and union nuts.

<sup>3</sup> Standard scope of delivery: Valve body only.

In order to make sure that the valves will be suitable for your particular application, please contact STAUFF with details on media, operating pressure, pressure peaks, operating temperature and the expected frequency of valve actuations.

Do not use with compressed air or gas!

Spillage: 1-1,5cm<sup>3</sup>/min at Pmax

Please note: Alternating valves have been designed as switching devices for hydraulic fluids, where the non-pressurized connection of the valve is automatically closed off and sealed by a moving ball made of steel.

Alternating valves are only suitable for connections that fit directly against the tube end stop of the valve body. Do not use in combination with 24° weld cone fittings, 24° DKO taper fittings and other types of fittings with no direct contact to the tube end stop of the valve body.

### Connecting Parts

	Cutting Ring Type <b>FI-DS</b>	Page 28
	Soft-Sealing Cutting Ring Type <b>FI-WDDS</b>	Page 29
	Support Sleeve Type <b>FI-VH</b>	Page 31
	STAUFF Form EVO Sealing Ring Type <b>FI-FD</b>	Page 32
	Union Nut Type <b>FI-M</b>	Page 33
	37° Flared Tube Fitting Set Type <b>FI-AB</b>	Page 37



### Maximum opening pressure for Hydraulic Valves

Series	Tube OD (mm/in)	max. opening pressure (FI-RVA,FI-RVVA, FI-RVZA, FI-RVIA)	max. opening pressure (FI-RV,FI-RVV, FI-RVZ, FI-RVI)
		Standard Version (bar/PSI)	High-Pressure Version (bar/PSI)
L	6	6	3
	.24	87	43.5
	8	6	3
	.31	87	43.5
	10	6	3
	.39	87	43.5
	12	6	3
	.47	87	43.5
	15	6	3
	.59	87	43.5
	18	6	3
	.71	87	43.5
	22	6	3
	.87	87	43.5
	28	6	3
	1.10	87	43.5
	35	5	3
1.38	72.5	43.5	
42	2	3	
1.65	29	43.5	
S	6	6	3
	.24	87	43.5
	8	6	3
	.31	87	43.5
	10	6	3
	.39	87	43.5
	12	6	3
	.47	87	43.5
	14	6	3
	.55	87	43.5
	16	6	3
	.63	87	43.5
	20	6	3
	.79	87	43.5
	25	6	3
	.98	87	43.5
	30	6	3
1.18	87	43.5	
38	5	3	
1.50	72.5	43.5	

M



Pressure Loss Graphs for Check Valves  
 High-Pressure Version  
 Type FI-RV • Series L / S

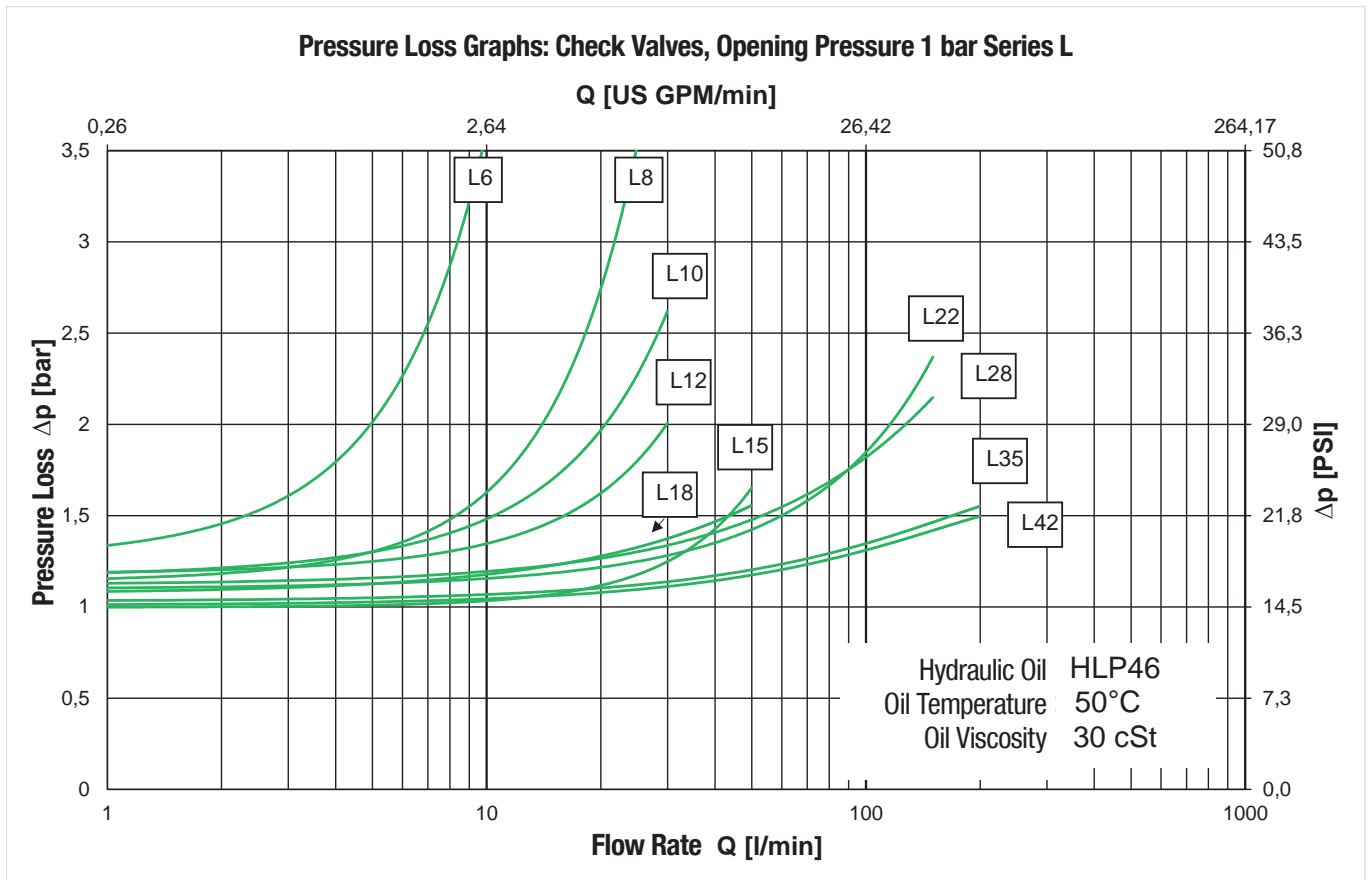

M

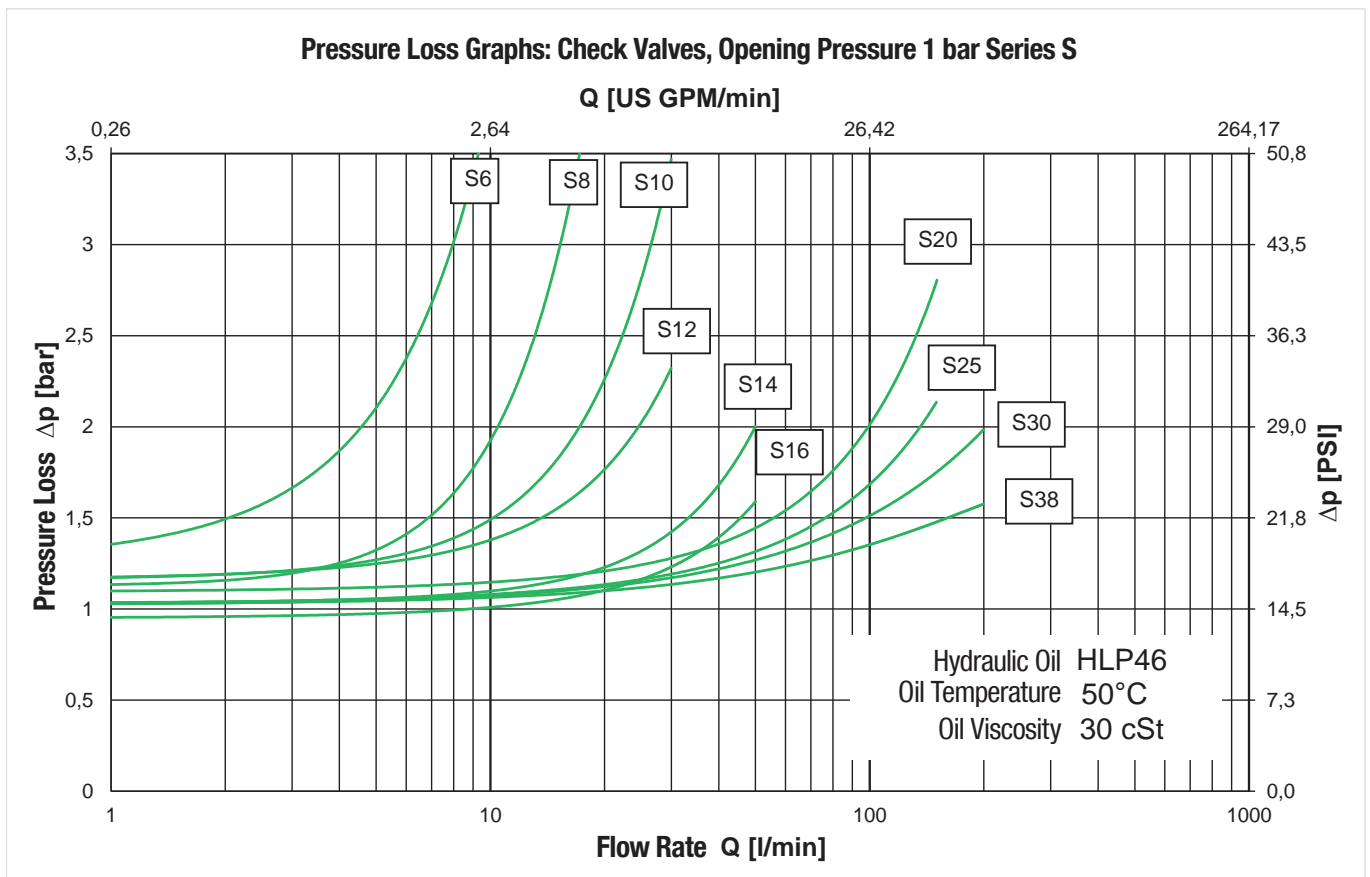

**Pressure Loss Graphs for Check Valves**  
**Standard Version**  
**Type FI-RVA • Series L / S**

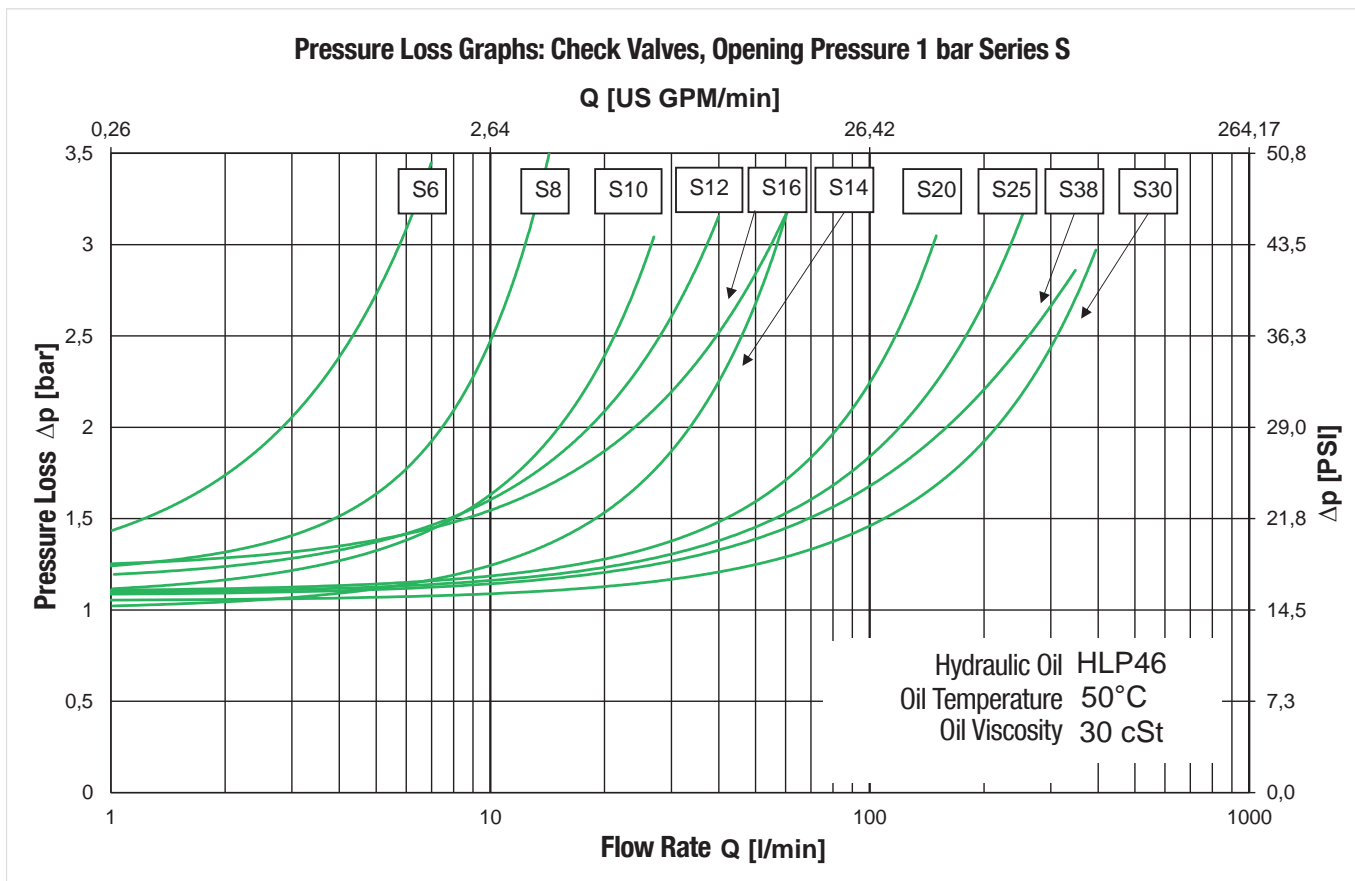
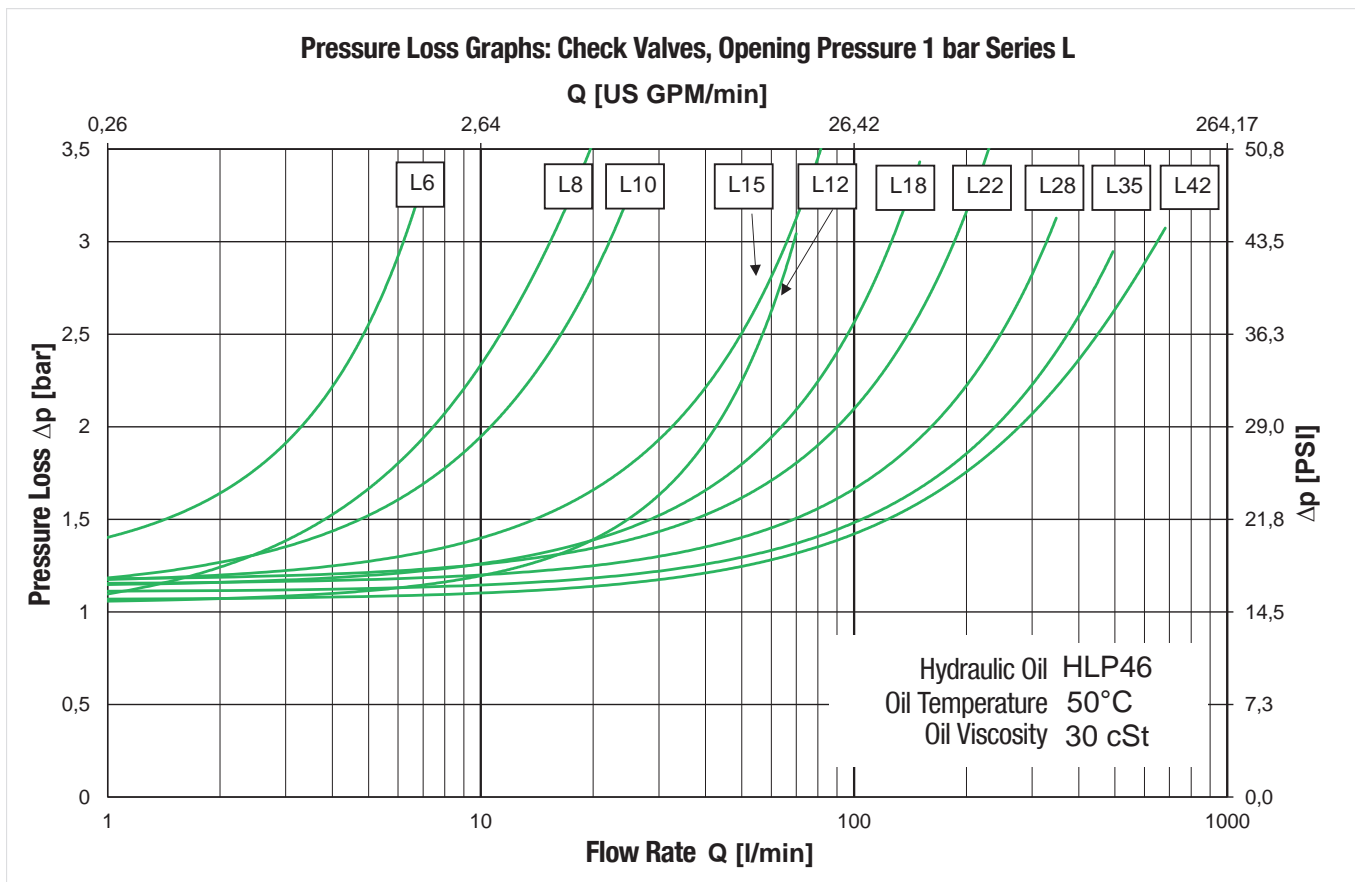

M





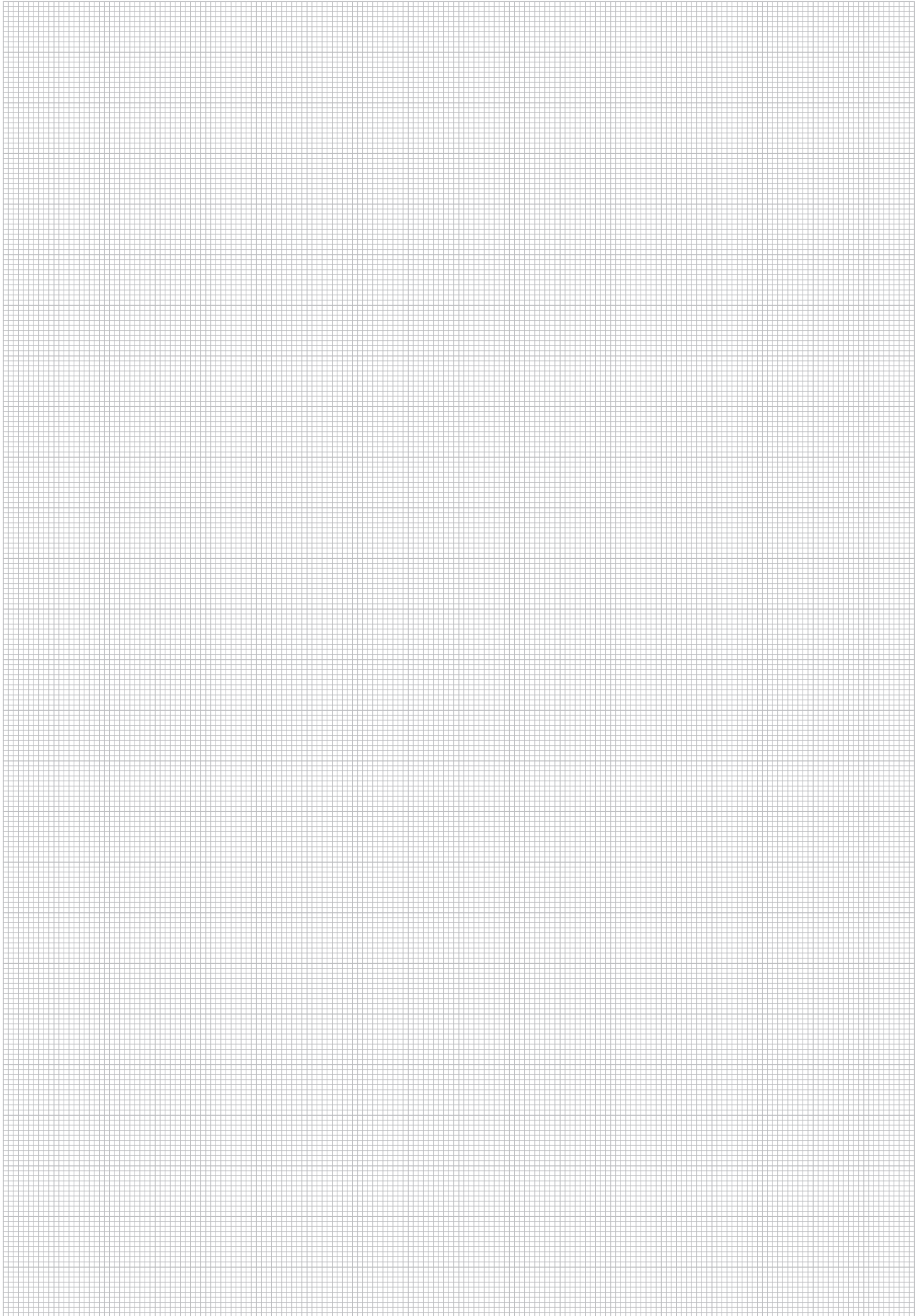

M



# Kommissionier-Shuttle WALTER II

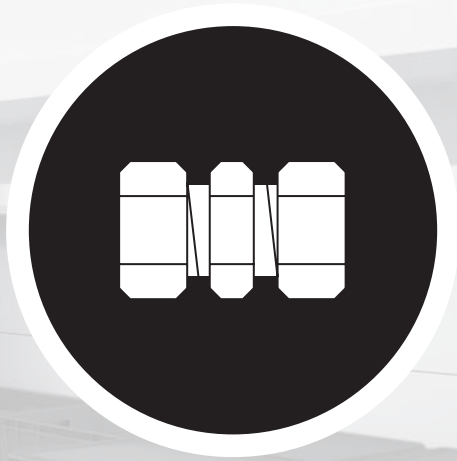

**Custom-Designed Solutions**

220

In addition to a complete range of standard components, STAUFF is also able offer individually designed special solutions according to customer's specifications or based on own developments.

Options include tube connectors with non-standard connection types and combinations, in special lengths and jump sizes or with throttle bores as well as distributors and manifolds in single-piece, soldered, brazed and welded construction.

Please do not hesitate to contact STAUFF for further information.





N

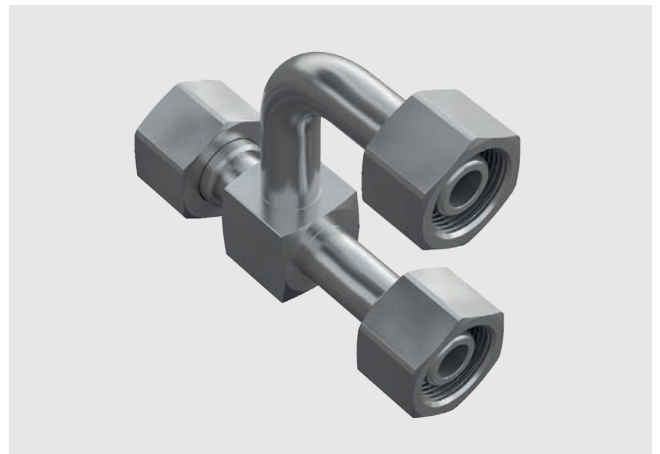
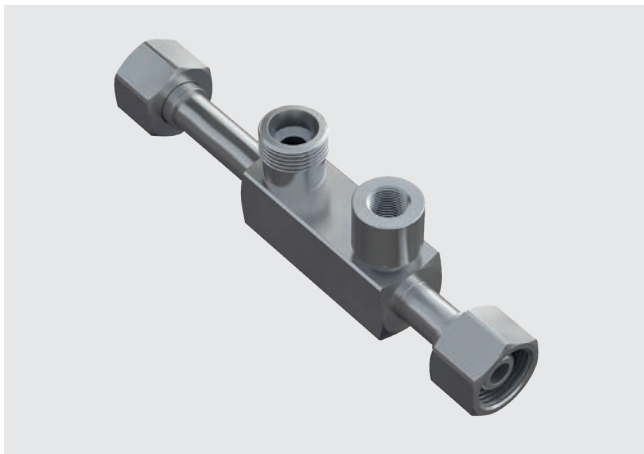

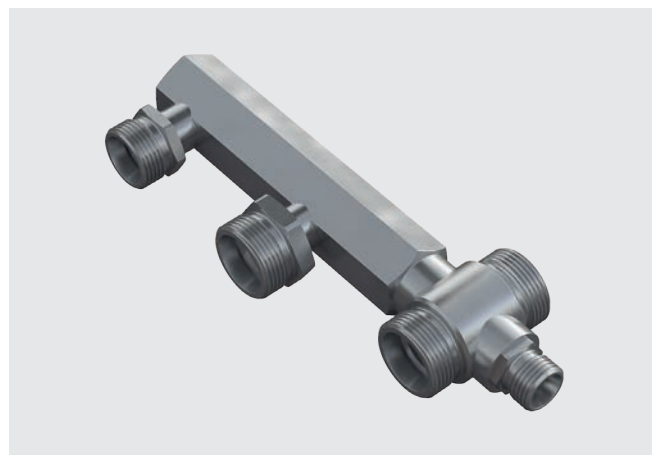
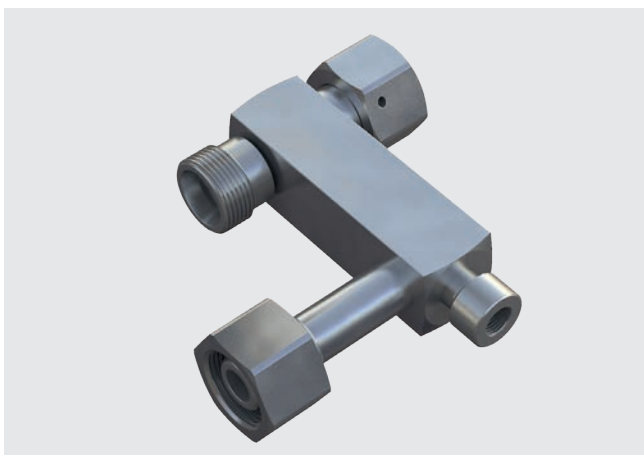





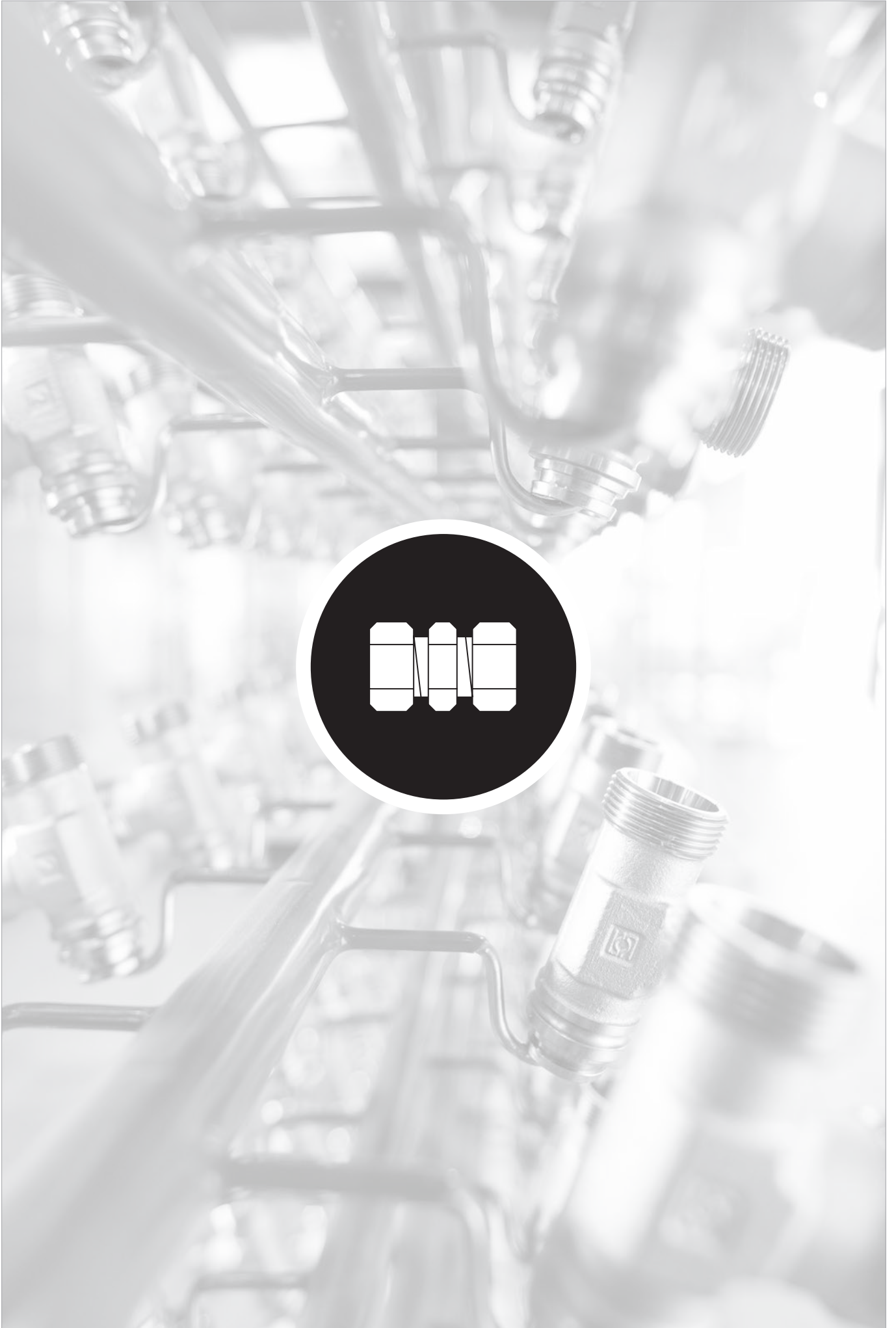













N





	<b>Thread Reducer</b> FI-RED	224-226		<b>Profile Sealing Ring</b> WDG	238
	<b>Whitworth Parallel Pipe Thread (BSPP) / Profile Sealing Ring</b> FI-RED-...-R-WD	224		<b>O-Ring</b> O-RING	239
	<b>Whitworth Parallel Pipe Thread (BSPP) / Metallic Sealing Edge</b> FI-RED-...-R	226		<b>External Metallic Sealing Ring</b> FI-DKR	244
	<b>Blanking Screw for Ports (Heavy Duty)</b> FI-VSV	228-229		<b>Retaining Ring with Captive Seal</b> FI-DIR	245
	<b>Whitworth Parallel Pipe Thread (BSPP) / Profile Sealing Ring</b> FI-VSV-...-R-WD	228		<b>Internal Metallic Sealing Ring</b> FI-DKI	246
	<b>Metric Parallel Thread / Profile Sealing Ring</b> FI-VSV-...-M-WD	229		<b>Retaining Ring (Small)</b> FI-KR	247
	<b>Blanking Screw for Ports</b> FI-VS	230-233			
	<b>Whitworth Parallel Pipe Thread (BSPP) / Profile Sealing Ring</b> FI-VS-...-R-WD	230			
	<b>Metric Parallel Thread / Profile Sealing Ring</b> FI-VS-...-M-WD	231			
	<b>Whitworth Parallel Pipe Thread (BSPP) / Metallic Sealing Edge</b> FI-VS-...-R	232			
	<b>Metric Parallel Thread / O-Ring</b> FI-VS-...-M-OR	233			
	<b>Blanking Plug with 24° Taper / O-Ring (DK0)</b> FI-VD	234			
	<b>Blanking Plug with Sealing Edge</b> FI-BUZ	235			
	<b>Blanking Plug for Tube Ends</b> FI-VSK	236			
	<b>Hexagon Lock Nut</b> FI-SKM	237			



**Thread Reducer**  
**Type FI-RED-...-R-WD**

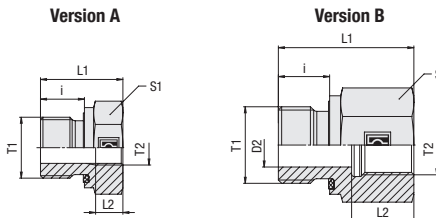

Male / Female Whitworth Parallel Pipe Thread (BSPP)

Profile Sealing Ring

**Ordering Codes**

**\*FI-RED\*-R\*1/2\*-WD\*-R\*3/8\*-B\*-W3**

- \* Thread Reducer** **FI-RED**
- \* Thread Type T1** Whitworth Parallel Pipe Thread (BSPP) **R**
- \* Thread Size T1** acc. to dimension table **1/2**
- Please always indicate thread sizes, e.g. 1/2!
- \* Seal Type** Profile Sealing Ring **-WD**
- \* Thread Type T2** Whitworth Parallel Pipe Thread (BSPP) **R**
- \* Thread Size T2** acc. to dimension table **3/8**
- Please always indicate thread sizes, e.g. 3/8!
- \* Seal Material** NBR (Buna-N®) **-B**  
FKM (Viton®) **-V**  
EPDM **-E**
- \* Material Code** Steel, zinc/nickel-plated **-W3**

Please contact STAUFF for alternative materials and surface finishings.

PN ( <sup>inch</sup> /FSS)	Dimensions ( <sup>mm</sup> /in)							Version	Torque ( <sup>N·m</sup> /ft·lb)	Weight ( <sup>kg</sup> /lbs) ca. per 100	Ordering Codes
	Thread T1	Thread T2	D2	L1	L2	i	S1				
630	G 1/8	G 1/4	4	31	17	8	19	B	25	4,30	FI-RED-R1/8-WD-R1/4-B-W3
9135			.16	1.22	.67	.31	.75		18.4	9.46	
630	G 1/8	G 3/8	4	32	17	8	24	B	25	6,70	FI-RED-R1/8-WD-R3/8-B-W3
9135			.16	1.26	.67	.31	.94		18.4	14.74	
630	G 1/4	G 1/8	5	29	12	12	19	B	55	4,40	FI-RED-R1/4-WD-R1/8-B-W3
9135			.20	1.14	.47	.47	.75		40.5	9.68	
630	G 1/4	G 1/4	8	35,5	17	12	22	B	55	4,26	FI-RED-R1/4-WD-R1/4-B-W3
9135			.31	1.40	.67	.47	.87		40.5	9.39	
630	G 1/4	G 3/8	5	36	17	12	24	B	55	7,30	FI-RED-R1/4-WD-R3/8-B-W3
9135			.20	1.42	.67	.47	.94		40.5	16.06	
630	G 1/4	G 1/2	5	40	20	12	30	B	55	12,80	FI-RED-R1/4-WD-R1/2-B-W3
9135			.20	1.57	.79	.47	1.18		40.5	28.16	
630	G 1/4	G 3/4	5	43	22	12	36	B	55	18,80	FI-RED-R1/4-WD-R3/4-B-W3
9135			.20	1.69	.87	.47	1.42		40.5	41.36	
630	G 3/8	G 1/8	8	22,5	8,5	12	22	A	80	4,20	FI-RED-R3/8-WD-R1/8-B-W3
9135			.89	.33	.47	.87			59	9,24	
630	G 3/8	G 1/4	8	36	17	12	22	B	80	7,40	FI-RED-R3/8-WD-R1/4-B-W3
9135			.31	1.42	.67	.47	.87		59	16.28	
630	G 3/8	G 1/2	8	41	20	12	30	B	80	13,60	FI-RED-R3/8-WD-R1/2-B-W3
9135			.31	1.61	.79	.47	1.18		59	29.92	
400	G 3/8	G 3/4	8	44	22	12	36	B	80	19,70	FI-RED-R3/8-WD-R3/4-B-W3
5800			.31	1.73	.87	.47	1.42		59	43.34	
630	G 1/2	G 1/8	12	24	8	14	27	A	115	7,00	FI-RED-R1/2-WD-R1/8-B-W3
9135			.94	.31	.55	1.06			84.8	15.40	
630	G 1/2	G 1/4	12	24	12	14	27	A	115	6,20	FI-RED-R1/2-WD-R1/4-B-W3
9135			.94	.47	.55	1.06			84.8	13.64	
630	G 1/2	G 3/8	12	37	17	14	27	B	115	10,40	FI-RED-R1/2-WD-R3/8-B-W3
9135			.47	1.46	.67	.55	1.06		84.8	22.88	
630	G 1/2	G 1/2	12	43	20	14	30	B	115	13,11	FI-RED-R1/2-WD-R1/2-B-W3
9135			.47	1.69	.79	.55	1.18		84.8	28.90	
400	G 1/2	G 3/4	12	46	22	14	36	B	115	20,10	FI-RED-R1/2-WD-R3/4-B-W3
5800			.47	1.81	.87	.55	1.42		84.8	44.22	
400	G 1/2	G 1	12	49	24,5	14	41	B	115	25,10	FI-RED-R1/2-WD-R1-B-W3
5800			.47	1.93	.96	.55	1.61		84.8	55.22	
250	G 1/2	G 1 1/4	10	53	26,5	14	55	B	115	52,10	FI-RED-R1/2-WD-R1-1/4-B-W3
3625			.39	2.09	1.04	.55	2.17		84.8	114.62	

Standard seal material is NBR (Buna-N®).

Male threaded studs were designed for female threaded ports in components made of steel. For applications with components made of softer mating materials (e.g. Aluminium), the use of connectors with additionally rolled male threads is recommended. Please contact STAUFF prior to the assembly for further information.

0

**Spare Parts / Accessories**



Profile Sealing Ring  
Type **WDG**

Page 238





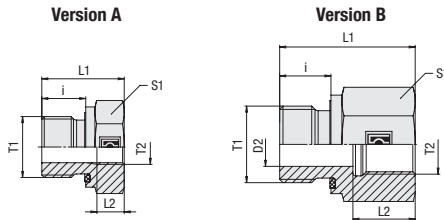

### Thread Reducer Type FI-RED-...-R-WD



#### Profile Sealing Ring

#### Male / Female Whitworth Parallel Pipe Thread (BSPP)

PN (bar/psi)	Dimensions (mm/in)							Version	Torque (Nm/ft-lb)	Weight (kg/lbs) ca. per 100	Ordering Codes
	Thread T1	Thread T2	D2	L1	L2	i	S1				
400	G 3/4	G 1/4		26	12,5	16	32	A	180	10,90	FI-RED-R3/4-WD-R1/4-B-W3
5800				1.02	.49	.63	1.26		123.7	23.98	
400	G 3/4	G 3/8		26	12,5	16	32	A	180	9,40	FI-RED-R3/4-WD-R3/8-B-W3
5800				1.02	.49	.63	1.26		123.7	20.68	
400	G 3/4	G 1/2	16	43	20	16	32	B	180	16,90	FI-RED-R3/4-WD-R1/2-B-W3
5800			.63	1.69	.79	.63	1.26		123.7	37.18	
400	G 3/4	G 3/4	16	48	22	16	41	B	180	18,96	FI-RED-R3/4-WD-R3/4-B-W3
5800			.63	1.89	.87	.63	1.61		123.7	41.80	
400	G 3/4	G 1	16	51	24,5	16	41	B	180	26,60	FI-RED-R3/4-WD-R1-B-W3
5800			.63	2.01	.96	.63	1.61		123.7	58.52	
250	G 3/4	G 1 1/4	16	55	26,5	16	55	B	180	52,70	FI-RED-R3/4-WD-R1-1/4-B-W3
3625			.63	2.17	1.04	.63	2.17		123.7	115.94	
250	G 3/4	G 1 1/2	16	57	28,5	16	60	B	180	61,10	FI-RED-R3/4-WD-R1-1/2-B-W3
3625			.63	2.24	1.12	.63	2.36		123.7	134.42	
400	G 1	G 1/4		29	12,5	18	41	A	310	20,70	FI-RED-R1-WD-R1/4-B-W3
5800				1.14	.49	.71	1.61		228.6	45.54	
400	G 1	G 3/8		29	12,5	18	41	A	310	19,10	FI-RED-R1-WD-R3/8-B-W3
5800				1.14	.49	.71	1.61		228.6	42.02	
400	G 1	G 1/2		29	14,5	18	41	A	310	16,80	FI-RED-R1-WD-R1/2-B-W3
5800				1.14	.57	.71	1.61		228.6	36.96	
400	G 1	G 3/4	20	49	22	18	41	B	310	31,30	FI-RED-R1-WD-R3/4-B-W3
5800			.79	1.93	.87	.71	1.61		228.6	68.86	
400	G 1	G 1	20	52	24,5	18	41	B	310	26,21	FI-RED-R1-WD-R1-B-W3
5800			.79	2.05	.96	.71	1.61		228.6	57.78	
250	G 1	G 1 1/4	20	57	26,5	18	55	B	310	58,80	FI-RED-R1-WD-R1-1/4-B-W3
3625			.79	2.24	1.04	.71	2.17		228.6	129.36	
250	G 1	G 1 1/2	20	59	28,5	18	60	B	310	63,90	FI-RED-R1-WD-R1-1/2-B-W3
3625			.79	2.32	1.12	.71	2.36		228.6	140.58	
400	G 1 1/4	G 1/2		32	14,5	20	50	A	450	33,00	FI-RED-R1-1/4-WD-R1/2-B-W3
5800				1.26	.57	.79	1.97		331,9	72.60	
400	G 1 1/4	G 3/4		32	16,5	20	50	A	450	28,30	FI-RED-R1-1/4-WD-R3/4-B-W3
5800				1.26	.65	.79	1.97		331,9	62.26	
400	G 1 1/4	G 1	25	53	24,5	20	50	B	450	50,60	FI-RED-R1-1/4-WD-R1-B-W3
5800			.98	2.09	.96	.79	1.97		331,9	111.32	
250	G 1 1/4	G 1 1/2	25	60	28,5	20	60	B	450	67,30	FI-RED-R1-1/4-WD-R1-1/2-B-W3
3625			.98	2.36	1.12	.79	2.36		331,9	148.06	
400	G 1 1/2	G 1/2		36	14,5	22	55	A	540	49,60	FI-RED-R1-1/2-WD-R1/2-B-W3
5800				1.42	.57	.87	2.17		398.3	109.12	
400	G 1 1/2	G 3/4		36	16	22	55	A	540	44,40	FI-RED-R1-1/2-WD-R3/4-B-W3
5800				1.42	.63	.87	2.17		398.3	97.68	
400	G 1 1/2	G 1		36	18,5	22	55	A	540	36,90	FI-RED-R1-1/2-WD-R1-B-W3
5800				1.42	.73	.87	2.17		398.3	81.18	
250	G 1 1/2	G 1 1/4		58	26,5	22	55	A	540	57,80	FI-RED-R1-1/2-WD-R1-1/4-B-W3
3625				2.28	1.04	.87	2.17		398.3	127.16	
160	G 2	G 1		46	19,5	24	75	A	700	99,8	FI-RED-R2-WD-R1-B-W3
2320				1.81	.77	.94	2.95		516.3	220.02	
160	G 2	G 1 1/4		48	20,5	24	75	A	700	93,70	FI-RED-R2-WD-R1-1/4-B-W3
2320				1.89	.81	.94	2.95		516.3	206.14	
160	G 2	G 1 1/2	40	65	29	24	75	B	700	132,20	FI-RED-R2-WD-R1-1/2-B-W3
2320			1.57	2.56	1.14	.94	2.95		516.3	290.84	

#### Ordering Codes

**\*FI-RED\*-R\*1/2\*-WD\*-R\*3/8\*-B\*-W3**

- \* Thread Reducer FI-RED
- \* Thread Type T1 Whitworth Parallel Pipe Thread (BSPP) R
- \* Thread Size T1 acc. to dimension table 1/2
- Please always indicate thread sizes, e.g. 1/2!
- \* Seal Type Profile Sealing Ring -WD
- \* Thread Type T2 Whitworth Parallel Pipe Thread (BSPP) R
- \* Thread Size T2 acc. to dimension table 3/8
- Please always indicate thread sizes, e.g. 3/8!
- \* Seal Material NBR (Buna-N®) -B  
FKM (Viton®) -V  
EPDM -E
- \* Material Code Steel, zinc/nickel-plated -W3

#### Spare Parts / Accessories



Profile Sealing Ring  
Type WDG

Page 238

Standard seal material is NBR (Buna-N®).

Male threaded studs were designed for female threaded ports in components made of steel. For applications with components made of softer mating materials (e.g. Aluminium), the use of connectors with additionally rolled male threads is recommended.

Please contact STAUFF prior to the assembly for further information.



### Thread Reducer Type FI-RED-...-R

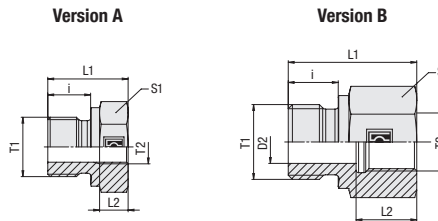

#### Male / Female Whitworth Parallel Pipe Thread (BSPP)

#### Metallic Sealing Edge

#### Ordering Codes

**\*FI-RED\*-R\*1/2\*-R\*3/8\*-B\*-W3**

- \* Thread Reducer** **FI-RED**
- \* Thread Type T1** Whitworth Parallel Pipe Thread (BSPP) **R**
- \* Thread Size T1** acc. to dimension table **1/2**  
Please always indicate thread sizes, e.g. 1/2!
- \* Thread Type T2** Whitworth Parallel Pipe Thread (BSPP) **R**
- \* Thread Size T2** acc. to dimension table **3/8**  
Please always indicate thread sizes, e.g. 3/8!
- \* Seal Material** NBR (Buna-N®) **-B**  
FKM (Viton®) **-V**  
EPDM **-E**
- \* Material Code** Steel, zinc/nickel-plated **-W3**  
Please contact STAUFF for alternative materials and surface finishings.

PN ( <sup>bar</sup> /PSI)	Dimensions (mm/in)							Version	Torque (N·m/ft·lb)	Weight (kg/lbs) ca. per 100	Ordering Codes
	Thread T1	Thread T2	D2	L1	L2	i	S1				
400	G 1/8	G 1/4	4	31	17	8	19	B	25	4,25	FI-RED-R1/8-R1/4-W3
5800			.16	1.22	.67	.31	.75		18.4	9.35	
400	G 1/8	G 3/8	4	32	17	8	24	B	25	6,15	FI-RED-R1/8-R3/8-W3
5800			.16	1.26	.67	.31	.94		18.4	13.53	
400	G 1/4	G 1/8	5	28	12	12	19	B	60	3,91	FI-RED-R1/4-R1/8-W3
5800			.20	1.10	.47	.47	.75		44.2	8.60	
400	G 1/4	G 3/8	5	36	17	12	24	B	60	6,80	FI-RED-R1/4-R3/8-W3
5800			.20	1.42	.67	.47	.94		44.2	14.96	
400	G 1/4	G 1/2	5	40	20	12	30	B	60	11,80	FI-RED-R1/4-R1/2-W3
5800			.20	1.57	.79	.47	1.18		44.2	25.96	
315	G 1/4	G 3/4	5	43	22	12	36	B	60	17,50	FI-RED-R1/4-R3/4-W3
4567,5			.20	1.69	.87	.47	1.42		44.2	38.50	
400	G 3/8	G 1/8	8	22,5	8	12	22	A	110	4,20	FI-RED-R3/8-R1/8-W3
5800			.31	.89	.31	.47	.87		81.1	9.24	
400	G 3/8	G 1/4	8	36	17	12	22	B	110	7,05	FI-RED-R3/8-R1/4-W3
5800			.31	1.42	.67	.47	.87		81.1	15.51	
400	G 3/8	G 1/2	8	41	20	12	30	B	110	17,80	FI-RED-R3/8-R1/2-W3
5800			.31	1.61	.79	.47	1.18		81.1	39.18	
315	G 3/8	G 3/4	8	44	22	12	36	B	110	18,40	FI-RED-R3/8-R3/4-W3
4567,5			.31	1.73	.87	.47	1.42		81.1	40.48	
400	G 1/2	G 1/8	12	24	8	14	27	A	200	6,58	FI-RED-R1/2-R1/8-W3
5800			.47	.94	.31	.55	1.06		147.5	14.48	
315	G 1/2	G 1/4	12	24	12,5	14	27	A	200	5,53	FI-RED-R1/2-R1/4-W3
4567,5			.47	.94	.49	.55	1.06		147.5	12.17	
315	G 1/2	G 3/8	12	36	17	14	27	B	200	9,30	FI-RED-R1/2-R3/8-W3
4567,5			.47	1.42	.67	.55	1.06		147.5	20.46	
315	G 1/2	G 3/4	12	46	22	14	36	B	200	18,50	FI-RED-R1/2-R3/4-W3
4567,5			.47	1.81	.87	.55	1.42		147.5	40.70	
315	G 1/2	G 1	12	49	24,5	14	41	B	200	22,70	FI-RED-R1/2-R1-W3
4567,5			.47	1.93	.96	.55	1.61		147.5	49.94	
160	G 1/2	G 1 1/4	12	53	26,5	14	55	B	200	48,10	FI-RED-R1/2-R1-1/4-W3
2320			.47	2.09	1.04	.55	2.17		147.5	105.82	

Male threaded studs were designed for female threaded ports in components made of steel. For applications with components made of softer mating materials (e.g. Aluminium), the use of connectors with additionally rolled male threads is recommended.

Please contact STAUFF prior to the assembly for further information.

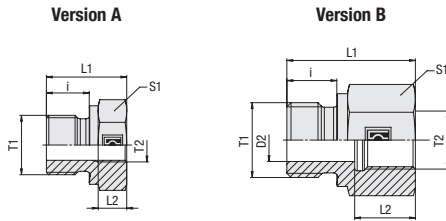

Thread Reducer  
 Type FI-RED-...-R

## Metallic Sealing Edge

## Male / Female Whitworth Parallel Pipe Thread (BSPP)

PN ( <sup>bar</sup> /psi)	Dimensions ( <sup>mm</sup> / <sub>in</sub> )		D2	L1	L2	i	S1	Version	Torque ( <sup>N·m</sup> / <sub>ft·lb</sub> )	Weight ( <sup>kg</sup> / <sub>lbs</sub> ) ca. per 100	Ordering Codes
	Thread T1	Thread T2									
400	G 3/4	G 1/4		26	12,5	16	32	A	320	10,20	FI-RED-R3/4-R1/4-W3
5800				1.02	.49	.63	1.26		236	22.44	
400	G 3/4	G 3/8		26	12,5	16	32	A	320	8,70	FI-RED-R3/4-R3/8-W3
5800				1.02	.49	.63	1.26		236	19.14	
400	G 3/4	G 1/2	16	41	20	16	32	B	320	14,60	FI-RED-R3/4-R1/2-W3
5800			.63	1.61	.79	.63	1.26		236	32.12	
400	G 3/4	G 1	16	51	24,5	16	41	B	320	24,60	FI-RED-R3/4-R1-W3
5800			.63	2.01	.96	.63	1.61		236	54.12	
400	G 3/4	G 1 1/4	16	55	26,5	16	55	B	320	48,40	FI-RED-R3/4-R1-1/4-W3
5800			.63	2.17	1.04	.63	2.17		236	106.48	
250	G 3/4	G 1 1/2	16	57	28,5	16	60	B	320	57,00	FI-RED-R3/4-R1-1/2-W3
3625			.63	2.24	1.12	.63	2.36		236	125.40	
315	G 1	G 1/4		29	12,5	18	41	A	500	19,10	FI-RED-R1-R1/4-W3
4567,5				1.14	.49	.71	1.61		368.8	42.02	
315	G 1	G 3/8		29	12,5	18	41	A	500	17,90	FI-RED-R1-R3/8-W3
4567,5				1.14	.49	.71	1.61		368.8	39.38	
315	G 1	G 1/2		29	14,5	18	41	A	500	15,40	FI-RED-R1-R1/2-W3
4567,5				1.14	.57	.71	1.61		368.8	33.88	
315	G 1	G 3/4	20	47	22	18	41	B	500	27,60	FI-RED-R1-R3/4-W3
4567,5			.79	1.85	.87	.71	1.61		368.8	60.72	
160	G 1	G 1 1/4	20	57	26,5	18	55	B	500	52,10	FI-RED-R1-R1-1/4-W3
2320			.79	2.24	1.04	.71	2.17		368.8	114.62	
160	G 1	G 1 1/2	20	59	28,5	18	60	B	500	59	FI-RED-R1-R1-1/2-W3
2320			.79	2.32	1.12	.71	2.36		368.8	130.07	
160	G 1 1/4	G 1/2		32	14,5	20	50	A	600	31,30	FI-RED-R1-1/4-R1/2-W3
2320				1.26	.57	.79	1.97		442.5	68.86	
160	G 1 1/4	G 3/4		32	16,5	20	50	A	600	26,50	FI-RED-R1-1/4-R3/4-W3
2320				1.26	.65	.79	1.97		442.5	58.30	
160	G 1 1/4	G 1	25	53	24,5	20	50	B	600	4,7	FI-RED-R1-1/4-R1-W3
2320			.98	2.09	.96	.79	1.97		442.5	10.36	
160	G 1 1/4	G 1 1/2	25	60	28,5	20	60	B	600	63,3	FI-RED-R1-1/4-R1-1/2-W3
2320			.98	2.36	1.12	.79	2.36		442.5	139.55	
160	G 1 1/2	G 1 1/4	32	58	26,5	22	55	B	800	53	FI-RED-R1-1/2-R1-1/4-W3
2320			1.26	2.28	1.04	.87	2.17		590	116.85	
160	G 1 1/2	G 1/2		36	14,5	22	55	A	800	47,30	FI-RED-R1-1/2-R1/2-W3
2320				1.42	.57	.87	2.17		590	104.06	
160	G 1 1/2	G 3/4		36	14,5	22	55	A	800	41,90	FI-RED-R1-1/2-R3/4-W3
2320				1.42	.57	.87	2.17		590	92.18	
160	G 1 1/2	G 1		36	18	22	55	A	800	34,10	FI-RED-R1-1/2-R1-W3
2320				1.42	.71	.87	2.17		590	75.02	
160	G 2	G 1 1/4		62	20,5	24	70	A	1000	99,50	FI-RED-R2-R1-1/4-W3
2320				2.44	.81	.94	2.76		737.6	218.90	
160	G 2	G 1 1/2	40	62	28,5	24	70	B	1000	107,30	FI-RED-R2-R1-1/2-W3
2320			1.57	2.44	1.12	.94	2.76		737.6	236.06	

## Ordering Codes

**\*FI-RED\*-R\*1/2\*-R\*3/8\*-B\*-W3**

* Thread Reducer		<b>FI-RED</b>
* Thread Type T1	Whitworth Parallel Pipe Thread (BSPP)	<b>R</b>
* Thread Size T1	acc. to dimension table	<b>1/2</b>
Please always indicate thread sizes, e.g. 1/2!		
* Thread Type T2	Whitworth Parallel Pipe Thread (BSPP)	<b>R</b>
* Thread Size T2	acc. to dimension table	<b>3/8</b>
Please always indicate thread sizes, e.g. 3/8!		
* Seal Material	NBR (Buna-N®) FKM (Viton®) EPDM	<b>-B</b> <b>-V</b> <b>-E</b>
* Material Code	Steel, zinc/nickel-plated	<b>-W3</b>
Please contact STAUFF for alternative materials and surface finishings.		

Male threaded studs were designed for female threaded ports in components made of steel. For applications with components made of softer mating materials (e.g. Aluminium), the use of connectors with additionally rolled male threads is recommended.

Please contact STAUFF prior to the assembly for further information.



## Blanking Screw for Ports (Heavy Duty) Type FI-VSV-...-R-WD

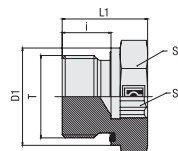

### Ordering Codes

#### \*FI-VSV\*-R\*1/2\*-WD\*-B\*-W3

* Blanking Screw for Ports		<b>FI-VSV</b>
* Thread Type	Whitworth Parallel Pipe Thread (BSPP)	<b>R</b>
* Thread Size	acc. to dimension table	<b>1/2</b>
Please always indicate thread sizes, e.g. 1/2!		
* Seal Type	Profile Sealing Ring	<b>-WD</b>
* Seal Material	NBR (Buna-N®) FKM (Viton®) EPDM	<b>-B</b> <b>-V</b> <b>-E</b>
* Material Code	Steel, zinc/nickel-plated	<b>-W3</b>

Please contact STAUFF for alternative materials and surface finishings.

### Spare Parts / Accessories



Profile Sealing Ring  
Type **WDG**

Page 238

### Whitworth Parallel Pipe Thread (BSPP)

### Profile Sealing Ring

PN ( <sup>bar</sup> /PSI)	Dimensions (mm/in)	Thread T	D1	L1	i	S1	S2	Torque (N·m/lb·ft)	Weight (kg/lbs) ca. per 100	Ordering Codes
400	G 1/8		14	18	8	5	14	18	1,56	FI-VSV-R1/8-WD-B-W3
5800			.55	.71	.31	.20	.55	13.3	3.43	
400	G 1/4		19	20	12	6	19	33	2,73	FI-VSV-R1/4-WD-B-W3
5800			.75	.79	.47	.24	.75	24.4	6.00	
400	G 3/8		22	22	12	8	22	70	4,48	FI-VSV-R3/8-WD-B-W3
5800			.87	.87	.47	.31	.87	51.8	9.85	
400	G 1/2		27	24	14	10	27	90	7,27	FI-VSV-R1/2-WD-B-W3
5800			1.06	.94	.55	.39	1.06	66.6	15.98	
400	G 3/4		32	28	16	12	32	181	13,02	FI-VSV-R3/4-WD-B-W3
5800			1.26	1.10	.63	.47	1.26	133.2	28.64	
400	G 1		46	33	18	17	46	250	23,80	FI-VSV-R1-WD-B-W3
5800			1.81	1.30	.71	.67	1.81	185.0	52.36	
400	G 1 1/4		57	38	20	22	60	400	42,00	FI-VSV-R1-1/4-WD-B-W3
5800			2.24	1.50	.79	.87	2.36	296.0	92.40	
400	G 1 1/2		64	40	22	24	65	500	55,60	FI-VSV-R1-1/2-WD-B-W3
5800			2.52	1.57	.87	.94	2.56	370.0	122.32	

Standard seal material is NBR (Buna-N®).

Male stud acc. to ISO 1179-2 (Type E)  
Port acc. to ISO 1179-1

Male threaded studs were designed for female threaded ports in components made of steel. For applications with components made of softer mating materials (e.g. Aluminium), the use of connectors with additionally rolled male threads is recommended.

Please contact STAUFF prior to the assembly for further information.

Torque recommendations with a tolerance of +10% and refer to original components from the STAUFF Connect product range made of steel with zinc/nickel coating and apply for Steel mating material.



Blanking Screw for Ports (Heavy Duty)  
Type FI-VSV-...-M-WD

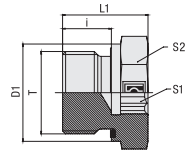

Profile Sealing Ring

Metric Parallel Thread

PN (bar/PSI)	Dimensions (mm/in)						Torque (N-m/ft-lb)	Weight (kg/lbs) Ca. per 100	Ordering Codes
	Thread T	D1	L1	i	S1	S2			
400	M 10 x 1	14	18	8	5	14	12	1,58	FI-VSV-M10x1-WD-B-W3
5800		.55	.71	.31	.20	.55	8.9	3.47	
400	M 12 x 1,5	17	20	12	6	17	25	2,13	FI-VSV-M12x1.5-WD-B-W3
5800		.67	.79	.47	.24	.67	18.5	4.69	
400	M 14 x 1,5	19	22	12	6	19	45	3,35	FI-VSV-M14x1.5-WD-B-W3
5800		.75	.87	.47	.24	.75	33.3	7.38	
400	M 16 x 1,5	22	22	12	8	22	55	4,30	FI-VSV-M16x1.5-WD-B-W3
5800		.87	.87	.47	.31	.87	40.7	9.46	
400	M 18 x 1,5	24	22	12	8	24	70	5,38	FI-VSV-M18x1.5-WD-B-W3
5800		.94	.87	.47	.31	.94	51.8	11.83	
400	M 20 x 1,5	27	22	14	10	27	80	6,09	FI-VSV-M20x1.5-WD-B-W3
5800		1.06	.87	.55	.39	1.06	59.2	13.39	
400	M 22 x 1,5	27	22	14	10	27	125	6,77	FI-VSV-M22x1.5-WD-B-W3
5800		1.06	.87	.55	.39	1.06	92.5	14.89	
400	M 26 x 1,5	32	30	16	12	32	180	14,33	FI-VSV-M26x1.5-WD-B-W3
5800		1.26	1.18	.63	.47	1.26	133.2	31.53	
400	M 27 x 2	32	28	16	12	32	180	13,23	FI-VSV-M27x2-WD-B-W3
5800		1.26	1.10	.63	.47	1.26	133.2	29.11	
400	M 33 x 2	40	33	18	17	41	250	29,32	FI-VSV-M33x2-WD-B-W3
5800		1.57	1.30	.71	.67	1.61	185.0	64.50	
400	M 42 x 2	50	38	20	22	50	400	57,35	FI-VSV-M42x2-WD-B-W3
5800		1.97	1.50	.79	.87	1.97	296.0	126.17	
400	M 48 x 2	55	40	22	24	55	500	73,79	FI-VSV-M48x2-WD-B-W3
5800		2.17	1.57	.87	.94	2.17	370.0	162.33	

Ordering Codes

**\*FI-VSV\*-M\*12x1.5\*-WD\*-B\*-W3**

- \* Blanking Screw for Ports FI-VSV
- \* Thread Type Metric Parallel Thread **M**
- \* Thread Size acc. to dimension table **12x1.5**
- Please always indicate thread sizes, e.g. 12x1.5!
- \* Seal Type Profile Sealing Ring **-WD**
- \* Seal Material NBR (Buna-N®) **-B**
- FKM (Viton®) **-V**
- EPDM **-E**
- \* Material Code Steel, zinc/nickel-plated **-W3**

Please contact STAUFF for alternative materials and surface finishings.

Spare Parts / Accessories



Profile Sealing Ring  
Type **WDG**

Page 238

Standard seal material is NBR (Buna-N®).

Male threaded studs were designed for female threaded ports in components made of steel. For applications with components made of softer mating materials (e.g. Aluminium), the use of connectors with additionally rolled male threads is recommended.

Please contact STAUFF prior to the assembly for further information.

Male stud acc. to ISO 9974-2 (Type E)  
Port acc. to ISO 9974-1

Torque recommendations with a tolerance of +10% and refer to original components from the STAUFF Connect product range made of steel with zinc/nickel coating and apply for Steel mating material.



## Blanking Screw for Ports Type FI-VS-...-R-WD

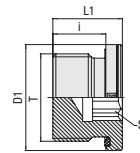

### Ordering Codes

**\*FI-VS\*-R\*1/2\*-WD\*-B\*-W3**

* Blanking Screw for Ports		<b>FI-VS</b>
* Thread Type	Whitworth Parallel Pipe Thread (BSPP)	<b>R</b>
* Thread Size	acc. to dimension table	<b>1/2</b>
Please always indicate thread sizes, e.g. 1/2!		
* Seal Type	Profile Sealing Ring	<b>-WD</b>
* Seal Material	NBR (Buna-N®) FKM (Viton®) EPDM	<b>-B</b> <b>-V</b> <b>-E</b>
* Material Code	Steel, zinc/nickel-plated	<b>-W3</b>
Please contact STAUFF for alternative materials and surface finishings.		

### Whitworth Parallel Pipe Thread (BSPP)

### Profile Sealing Ring

PN ( <sup>inch</sup> / <sub>PSI</sub> )	Dimensions ( <sup>mm</sup> / <sub>in</sub> )					Torque ( <sup>N-m</sup> / <sub>ft-lb</sub> )	Weight ( <sup>kg</sup> / <sub>lbs</sub> ) ca. per 100	Ordering Codes
	Thread T	D1	L1	i	S1			
400	G 1/8	14	12,3	8	5	15	0,70	FI-VS-R1/8-WD-B-W3
5800		.55	.48	.31	.20	11.1	1.54	
400	G 1/4	19	17,3	12	6	25	1,90	FI-VS-R1/4-WD-B-W3
5800		.75	.68	.47	.24	18.5	4.18	
400	G 3/8	22	17,3	12	8	50	2,70	FI-VS-R3/8-WD-B-W3
5800		.87	.68	.47	.31	37.0	5.94	
400	G 1/2	27	19,3	14	10	70	4,60	FI-VS-R1/2-WD-B-W3
5800		1.06	.76	.55	.39	51.8	10.12	
400	G 3/4	32	21,3	16	12	120	8,00	FI-VS-R3/4-WD-B-W3
5800		1.26	.84	.63	.47	88.8	17.60	
400	G 1	40	22,8	16	17	200	12,80	FI-VS-R1-WD-B-W3
5800		1.57	.90	.63	.67	148.0	28.16	
315	G 1 1/4	50	22,8	16	22	320	19,90	FI-VS-R1-1/4-WD-B-W3
4568		1.97	.90	.63	.87	236.8	43.78	
315	G 1 1/2	55	22,8	16	24	400	26,20	FI-VS-R1-1/2-WD-B-W3
4568		2.17	.90	.63	.94	296.0	57.64	

Standard seal material is NBR (Buna-N®).

Male stud acc. to ISO 1179-2 (Type E)  
Port acc. to ISO 1179-1

Male threaded studs were designed for female threaded ports in components made of steel. For applications with components made of softer mating materials (e.g. Aluminium), the use of connectors with additionally rolled male threads is recommended.  
Please contact STAUFF prior to the assembly for further information.

Torque recommendations with a tolerance of +10% and refer to original components from the STAUFF Connect product range made of steel with zinc/nickel coating and apply for Steel mating material.

### Spare Parts / Accessories



Profile Sealing Ring  
Type **WDG**

Page 238

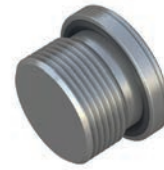
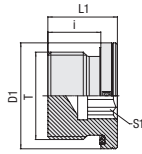

Blanking Screw for Ports  
 Type FI-VS-...-M-WD

## Profile Sealing Ring

## Metric Parallel Thread

PN (bar/psi)	Dimensions (mm/in)					Torque (N·m/ft·lb)	Weight (kg/lbs) Ca. per 100	Ordering Codes
	Thread T	D1	L1	i	S1			
400	M 8 x 1	12	12	8	4	10	0,50	FI-VS-M8x1-WD-B-W3
5800		.47	.47	.31	.16	7.4	1.10	
400	M 10 x 1	14	12,3	8	5	12	0,70	FI-VS-M10x1-WD-B-W3
5800		.55	.48	.31	.20	8.9	1.54	
400	M 12 x 1,5	17	17,3	12	6	23	1,50	FI-VS-M12x1.5-WD-B-W3
5800		.67	.68	.47	.24	17.0	3.30	
400	M 14 x 1,5	19	17,3	12	6	30	2,00	FI-VS-M14x1.5-WD-B-W3
5800		.75	.68	.47	.24	22.2	4.40	
400	M 16 x 1,5	22	17,3	12	8	50	2,60	FI-VS-M16x1.5-WD-B-W3
5800		.87	.68	.47	.31	37.0	5.72	
400	M 18 x 1,5	24	17,3	12	8	65	3,30	FI-VS-M18x1.5-WD-B-W3
5800		.94	.68	.47	.31	48.1	7.26	
400	M 20 x 1,5	26	19,3	14	10	80	4,30	FI-VS-M20x1.5-WD-B-W3
5800		1.02	.76	.55	.39	59.2	9.46	
400	M 22 x 1,5	27	19,3	14	10	90	5,10	FI-VS-M22x1.5-WD-B-W3
5800		1.06	.76	.55	.39	66.6	11.22	
400	M 26 x 1,5	32	21,3	16	12	100	8,00	FI-VS-M26x1.5-WD-B-W3
5800		1.26	.84	.63	.47	74.0	17.60	
400	M 27 x 2	32	21,3	16	12	130	8,20	FI-VS-M27x2-WD-B-W3
5800		1.26	.84	.63	.47	96.2	18.04	
400	M 33 x 2	40	22,8	16	17	250	13,10	FI-VS-M33x2-WD-B-W3
5800		1.57	.90	.63	.67	185.0	28.82	
250	M 42 x 2	50	22,8	16	22	310	20,40	FI-VS-M42x2-WD-B-W3
3625		1.97	.90	.63	.87	229.4	44.88	
250	M 48 x 2	55	22,8	16	24	380	26,90	FI-VS-M48x2-WD-B-W3
3625		2.17	.90	.63	.94	281.2	59.18	

## Ordering Codes

**\*FI-VS\*-M\*12x1.5\*-WD\*-B\*-W3**

* Blanking Screw for Ports		<b>FI-VS</b>
* Thread Type	Metric Parallel Thread	<b>M</b>
* Thread Size	acc. to dimension table	<b>12x1.5</b>
Please always indicate thread sizes, e.g. 12x1.5!		
* Seal Type	Profile Sealing Ring	<b>-WD</b>
* Seal Material	NBR (Buna-N®)	<b>-B</b>
	FKM (Viton®)	<b>-V</b>
	EPDM	<b>-E</b>
* Material Code	Steel, zinc/nickel-plated	<b>-W3</b>

Please contact STAUFF for alternative materials and surface finishings.

## Spare Parts / Accessories



Profile Sealing Ring  
 Type **WDG**

Page 238

Standard seal material is NBR (Buna-N®).

Male threaded studs were designed for female threaded ports in components made of steel. For applications with components made of softer mating materials (e.g. Aluminium), the use of connectors with additionally rolled male threads is recommended.

Please contact STAUFF prior to the assembly for further information.

Male stud acc. to ISO 9974-2 (Type E)  
 Port acc. to ISO 9974-1

Torque recommendations with a tolerance of +10% and refer to original components from the STAUFF Connect product range made of steel with zinc/nickel coating and apply for Steel mating material.



## Blanking Screw for Ports Type FI-VS-...-R

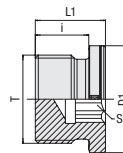

### Ordering Codes

#### \*FI-VS\*-R\*1/2\*-W3

\* Blanking Screw for Ports

\* Thread Type Whitworth Parallel Pipe Thread (BSPP)

\* Thread Size acc. to dimension table

Please always indicate thread sizes, e.g. 1/2!

\* Material Code Steel, zinc/nickel-plated

Please contact STAUFF for alternative materials and surface finishings.

FI-VS

R

1/2

-W3

### Whitworth Parallel Pipe Thread (BSPP)

### Metallic Sealing Edge

PN ( <sup>bar</sup> /PSI)	Dimensions ( <sup>mm</sup> / <sup>in</sup> )					Torque ( <sup>N·m</sup> / <sup>ft·lb</sup> )	Weight ( <sup>kg</sup> / <sup>lbs</sup> ) ca. per 100	Ordering Codes
	Thread T	D1	L1	i	S1			
400	G 1/8	14	12,3	8	5	25	0,70	FI-VS-R1/8-W3
5800		.55	.48	.31	.20	18.5	1.54	
400	G 1/4	18	17,3	12	6	40	1,80	FI-VS-R1/4-W3
5800		.71	.68	.47	.24	29.6	3.96	
400	G 3/8	22	17,3	12	8	95	2,70	FI-VS-R3/8-W3
5800		.87	.68	.47	.31	70.3	5.94	
400	G 1/2	26	19,3	14	10	130	4,60	FI-VS-R1/2-W3
5800		1.02	.76	.55	.39	96.2	10.12	
400	G 3/4	32	21,3	16	12	250	7,90	FI-VS-R3/4-W3
5800		1.26	.84	.63	.47	185.0	17.38	
400	G 1	39	22,8	16	17	400	12,80	FI-VS-R1-W3
5800		1.54	.90	.63	.67	296.0	28.16	
315	G 1 1/4	49	22,8	16	22	600	19,30	FI-VS-R1-1/4-W3
4567,5		1.93	.90	.63	.87	444.0	42.46	
315	G 1 1/2	55	22,8	16	24	800	26,10	FI-VS-R1-1/2-W3
4567,5		2.17	.90	.63	.94	592.0	57.42	

Male threaded studs were designed for female threaded ports in components made of steel. For applications with components made of softer mating materials (e.g. Aluminium), the use of connectors with additionally rolled male threads is recommended.

Please contact STAUFF prior to the assembly for further information.

Male stud acc. to DIN 3852-2 (Form B) / ISO 1179-4 (Type B)  
Port acc. to DIN 3852-2 (Form X) / ISO 1179-1

Torque recommendations with a tolerance of +10% and refer to original components from the STAUFF Connect product range made of steel with zinc/nickel coating and apply for Steel mating material.





### Blanking Screw for Ports Type FI-VS-...-M-OR

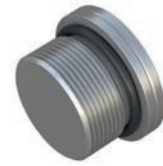
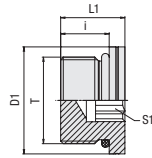

#### O-Ring

#### Metric Parallel Thread

PN (bar/psi)	Dimensions (mm/in)		L1	i	S1	Torque (N·m/ft·lb)	Weight (kg/lbs) Ca.	Ordering Codes
	Thread T	D1				Thread T	per 100	
630	M 10 x 1	13,8	13,5	9,5	5	15	0,8	FI-VS-M10x1-OR-B-W3
9135		.54	.53	.37	.20	11.1	1.76	
630	M 12 x 1,5	16,8	15,5	11	6	22	1,4	FI-VS-M12x1.5-OR-B-W3
9135		.66	.61	.43	.24	16.3	3.08	
630	M 14 x 1,5	18,8	16	11	6	45	2,0	FI-VS-M14x1.5-OR-B-W3
9135		.74	.63	.43	.24	33.3	4.40	
630	M 16 x 1,5	21,8	17,5	12,5	8	55	2,7	FI-VS-M16x1.5-OR-B-W3
9135		.86	.69	.49	.31	40.7	5.94	
630	M 18 x 1,5	23,8	19	14	8	70	3,8	FI-VS-M18x1.5-OR-B-W3
9135		.94	.75	.55	.31	51.8	8.36	
630	M 22 x 1,5	26,8	20	15	10	100	5,5	FI-VS-M22x1.5-OR-B-W3
9135		1.06	.79	.59	.39	74.0	12.10	
400	M 26 x 1,5	31,8	21	16	12	170	7,7	FI-VS-M26x1.5-OR-B-W3
5800		1.25	.83	.63	.47	125.8	16.94	
400	M 27 x 2	31,8	23,5	18,5	12	180	9,4	FI-VS-M27x2-OR-B-W3
5800		1.25	.93	.73	.47	133.2	20.68	
400	M 33 x 2	40,8	24,5	18,5	14	215	15,6	FI-VS-M33x2-OR-B-W3
5800		1.61	.96	.73	.55	159.1	34.32	
400	M 42 x 2	49,8	25	19	22	330	24,5	FI-VS-M42x2-OR-B-W3
5800		1.96	.98	.75	.87	244.2	53.90	
400	M 48 x 2	54,8	27,5	21,5	24	420	37,1	FI-VS-M48x2-OR-B-W3
5800		2.16	1.08	.85	.94	310.8	81.62	

Standard seal material is NBR (Buna-N®).

Male stud acc. to ISO 6149-2/-3  
Port acc. to ISO 6149-1

Male threaded studs were designed for female threaded ports in components made of steel. For applications with components made of softer mating materials (e.g. Aluminium), the use of connectors with additionally rolled male threads is recommended.

Please contact STAUFF prior to the assembly for further information.

Torque recommendations with a tolerance of +10% and refer to original components from the STAUFF Connect product range made of steel with zinc/nickel coating and apply for Steel mating material.

#### Ordering Codes

#### \*FI-VS\*-M\*12x1.5\*-OR\*-B\*-W3

* Blanking Screw for Ports	FI-VS
* Thread Type	Metric Parallel Thread <b>M</b>
* Thread Size	acc. to dimension table <b>12x1.5</b>
Please always indicate thread sizes, e.g. 12x1.5!	
* Seal Type	O-Ring <b>-OR</b>
* Seal Material	NBR (Buna-N®) <b>-B</b> FKM (Viton®) <b>-V</b> EPDM <b>-E</b>
* Material Code	Steel, zinc/nickel-plated <b>-W3</b>

Please contact STAUFF for alternative materials and surface finishings.

#### Spare Parts / Accessories



O-Ring  
Type **O-RING**

Page 239



## Blanking Plug with 24° Taper / O-Ring (DKO) Type FI-VD • Series L / S

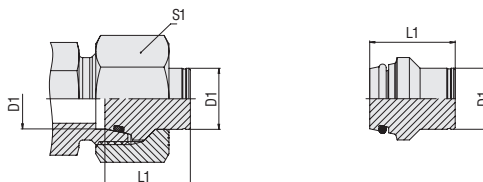

### Ordering Codes

**\*FI-VD\*-15\*L\*-V\*-W3\*-M**

- \* Blanking Plug with 24° Taper / O-Ring (DKO) **FI-VD**
  - \* Outside Tube Diameter D1 (in mm) **-15**
  - \* Series **L**  
Light Series  
Heavy Series **S**
  - \* Seal Material **-V**  
FKM (Viton®)  
EPDM **-E**
  - \* Material Code **-W3**  
Steel, zinc/nickel-plated
- Please contact STAUFF for alternative materials and surface finishings.
- \* Assembling / Kitting Blanking plug only **—**
  - Blanking plug supplied with union nut **-M**

### Connecting Parts



Union Nut  
Type **FI-M**

Page 33

### Spare Parts / Accessories



O-Ring  
Type **O-RING**

Page 239

Series	Tube OD	PN	Dimensions		Weight (kg/lbs) ca. per 100	Ordering Codes <sup>3</sup>
	(mm/in) D1		(bar/psi)	(mm/in) L1 <sup>1</sup>		
L	6	800	17	14	0,55	FI-VD-06L/S-V-W3
	.24	11600	.67	.55	1.21	
	8	800	17	17	0,91	FI-VD-08L/S-V-W3
	.31	11600	.67	.67	2.02	
	10	800	20	19	1,55	FI-VD-10L/S-V-W3
	.39	11600	.79	.75	3.41	
	12	630	21	22	2,23	FI-VD-12L/S-V-W3
	.47	9135	.83	.87	4.91	
	15	400	20	27	3,60	FI-VD-15L-V-W3
	.59	5800	.79	1.06	7.92	
	18	400	21	32	4,88	FI-VD-18L-V-W3
	.71	5800	.83	1.26	10.74	
	22	250	23	36	7,70	FI-VD-22L-V-W3
	.87	3625	.91	1.42	16.94	
	28	250	23	41	12,00	FI-VD-28L-V-W3
	1.10	3625	.91	1.61	26.40	
	35	250	29	50	24,00	FI-VD-35L-V-W3
	1.38	3625	1.14	1.97	52.80	
	42	250	30	60	35,00	FI-VD-42L-V-W3
	1.65	3625	1.18	2.36	77.00	
S	6	800	17	17	0,55	FI-VD-06L/S-V-W3
	.24	11600	.67	.67	1.21	
	8	800	17	19	0,91	FI-VD-08L/S-V-W3
	.31	11600	.67	.75	20.01	
	10	800	20	22	1,55	FI-VD-10L/S-V-W3
	.39	11600	.79	.87	3.41	
	12	630	21	24	2,23	FI-VD-12L/S-V-W3
	.47	9135	.83	.94	4.91	
	14	630	23	27	3,30	FI-VD-14S-V-W3
	.55	9135	.91	1.06	7.26	
	16	630	24	30	4,30	FI-VD-16S-V-W3
	.63	9135	.94	1.18	9.46	
	20	420	28	36	8,10	FI-VD-20S-V-W3
	.79	6091	1.10	1.42	17.82	
	25	420	31	46	13,50	FI-VD-25S-V-W3
	.98	6091	1.22	1.81	29.70	
	30	420	34	50	21,20	FI-VD-30S-V-W3
	1.18	6091	1.34	1.97	46.64	
	38	420	38	60	36,90	FI-VD-38S-V-W3
	1.50	6091	1.50	2.36	81.18	

<sup>1</sup> Approximate dimension in assembled condition.

<sup>2</sup> Weight excluding union nut.

<sup>3</sup> Standard scope of delivery: Blanking plug only.

Standard seal material is FKM (Viton®).



## Blanking Plug with Sealing Edge Type FI-BUZ • Series L / S

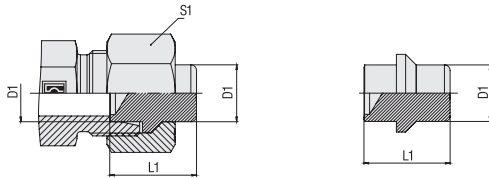

Series	Tube OD	PN	Dimensions		Weight ( <sup>kg</sup> / <sub>lbs</sub> ) ca. per 100	Ordering Codes <sup>3</sup>
	( <sup>mm</sup> / <sub>in</sub> ) D1		( <sup>bar</sup> / <sub>PSI</sub> )	( <sup>mm</sup> / <sub>in</sub> ) L1 <sup>1</sup>		
L	6	500	19,5	14	0,55	FI-BUZ-06L/S-W3
	.24	7250	.77	.55	1.21	
	8	500	19,5	17	0,90	FI-BUZ-08L/S-W3
	.31	7250	.77	.67	1.98	
	10	500	21,5	19	1,48	FI-BUZ-10L/S-W3
	.39	7250	.85	.75	3.57	
	12	400	22	22	2,13	FI-BUZ-12L/S-W3
	.47	5800	.87	.87	4.69	
	15	400	22	27	3,20	FI-BUZ-15L-W3
	.59	5800	.87	1.06	7.04	
	18	400	24	32	5,00	FI-BUZ-18L-W3
	.71	5800	.94	1.26	11.00	
	22	250	26	36	7,90	FI-BUZ-22L-W3
	.87	3625	1.02	1.42	17.38	
	28	250	25,5	41	11,90	FI-BUZ-28L-W3
	1.10	3625	1.00	1.61	26.18	
	35	250	32	50	23,50	FI-BUZ-35L-W3
	1.38	3625	1.26	1.97	51.70	
	42	250	32,5	60	38,50	FI-BUZ-42L-W3
	1.65	3625	1.28	2.36	84.70	
S	6	800	19,5	17	0,55	FI-BUZ-06L/S-W3
	.24	11600	.77	.67	1.21	
	8	800	19,5	19	0,90	FI-BUZ-08L/S-W3
	.31	11600	.77	.75	1.98	
	10	800	21,5	22	1,48	FI-BUZ-10L/S-W3
	.39	11600	.85	.87	3.57	
	12	630	22	24	2,13	FI-BUZ-12L/S-W3
	.47	9135	.87	.94	4.69	
	14	630	23,5	27	3,12	FI-BUZ-14S-W3
	.55	9135	.93	1.06	6.86	
	16	630	25,5	30	4,27	FI-BUZ-16S-W3
	.63	9135	1.00	1.18	9.93	
	20	400	30,5	36	8,00	FI-BUZ-20S-W3
	.79	5800	1.20	1.42	17.60	
	25	400	32,5	46	17,90	FI-BUZ-25S-W3
	.98	5800	1.28	1.81	39.38	
	30	400	35,5	50	20,00	FI-BUZ-30S-W3
	1.18	5800	1.40	1.97	44.00	
	38	400	42	60	36,60	FI-BUZ-38S-W3
	1.50	5800	1.65	2.36	80.52	

<sup>1</sup> Approximate dimension in assembled condition.

<sup>2</sup> Weight excluding union nut.

<sup>3</sup> Standard scope of delivery: Blanking plug only.

### Ordering Codes

**\*FI-BUZ\*-15\*L\*-W3\*-M**

* Blanking Plug with Sealing Edge	<b>FI-BUZ</b>
* Outside Tube Diameter D1 (in mm)	<b>-15</b>
* Series	Light Series <b>L</b> Heavy Series <b>S</b>
* Material Code	Steel, zinc/nickel-plated <b>-W3</b>
Please contact STAUFF for alternative materials and surface finishings.	
* Assembling / Kitting	Blanking plug only <b>—</b> Blanking plug supplied with union nut <b>-M</b>

### Connecting Parts



Union Nut  
Type FI-M

Page 33



## Blanking Plug for Tube Ends Type FI-VSK ▪ Series L / S

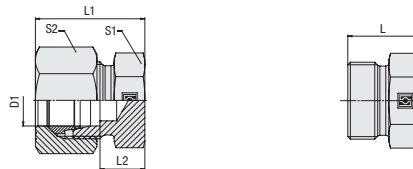

### Ordering Codes

#### \*FI-VSK\*-10\*L\*-W3\*-MS

- \* Blanking Plug for Tube Ends **FI-VSK**
- \* Outside Tube Diameter D1 (in mm) **-10**
- \* Series **L**  
Light Series **S**  
Heavy Series
- \* Material Code **-W3**  
Steel, zinc/nickel-plated
- Please contact STAUFF for alternative materials and surface finishings.
- \* Assembling / Kitting **—**  
Blanking plug only
- Blanking plug supplied with cutting ring and union nut **-MS**
- Blanking plug supplied with soft-sealing cutting ring and union nut **-MSV**

### Connecting Parts

-  Cutting Ring  
Type **FI-DS** Page 28
-  Soft-Sealing Cutting Ring  
Type **FI-WDDS** Page 29
-  Support Sleeve  
Type **FI-VH** Page 31
-  STAUFF Form EVO Sealing Ring  
Type **FI-FD** Page 32
-  Union Nut  
Type **FI-M** Page 33
-  37° Flared Tube Fitting Set  
Type **FI-AB** Page 37

Series	Tube OD	PN	Dimensions					Weight (kg/lbs) ca. per 100	Ordering Codes <sup>3</sup>
	(mm/in) D1		(bar/psi)	(mm/in) L	L1 <sup>1</sup>	L2	S1		
L	6	315	17	22	7	14	14	1,40	FI-VSK-06L-W3
	.24	4568	.55	.87	.28	.47	.55	3,08	
	8	315	17	23	8	17	17	1,93	FI-VSK-08L-W3
	.31	4568	.59	.91	.31	.55	.67	4,24	
	10	315	20	24	9	17	19	2,55	FI-VSK-10L-W3
	.39	4568	.63	.94	.35	.67	.75	5,61	
	12	315	21	25	10	19	22	3,44	FI-VSK-12L-W3
	.47	4568	.67	.98	.39	.75	.87	8,74	
	15	315	20	26	11	24	27	4,90	FI-VSK-15L-W3
	.59	4568	.71	1.02	.43	.94	1.06	10,78	
	18	315	21	28	11,5	27	32	6,80	FI-VSK-18L-W3
	.71	4568	.75	1.10	.45	1.06	1.26	14,96	
	22	160	23	30	13,5	32	36	10,70	FI-VSK-22L-W3
	.87	2320	.83	1.18	.53	1.26	1.42	23,54	
	28	160	23	31	14,5	41	41	15,20	FI-VSK-28L-W3
	1.10	2320	.87	1.22	.57	1.61	1.61	33,44	
	35	160	29	36	14,5	46	50	25,90	FI-VSK-35L-W3
	1.38	2320	.98	1.42	.57	1.81	1.97	56,98	
	42	160	30	39	16	55	60	35,30	FI-VSK-42L-W3
	1.65	2320	1.06	1.54	.63	2.17	2.36	77,66	
S	6	630	17	26	11	17	17	1,80	FI-VSK-06S-W3
	.24	9135	.71	1.02	.43	.55	.67	3,96	
	8	630	17	28	13	17	19	2,16	FI-VSK-08S-W3
	.31	9135	.79	1.10	.51	.67	.75	4,75	
	10	630	20	29	12,5	19	22	3,34	FI-VSK-10S-W3
	.39	9135	.79	1.14	.49	.75	.87	7,35	
	12	630	21	31	14,5	22	24	4,60	FI-VSK-12S-W3
	.47	9135	.87	1.22	.57	.87	.94	10,12	
	14	630	23	34	16	24	27	5,88	FI-VSK-14S-W3
	.55	9135	.94	1.34	.63	.94	1.06	12,94	
	16	400	24	34	15,5	27	30	7,54	FI-VSK-16S-W3
	.63	5800	.94	1.34	.61	1.06	1.18	16,59	
	20	420	28	39	17,5	32	36	12,50	FI-VSK-20S-W3
	.79	6091	1.10	1.54	.69	1.26	1.42	27,50	
	25	420	31	44	20	41	46	21,40	FI-VSK-25S-W3
	.98	6091	1.26	1.73	.79	1.61	1.81	47,08	
	30	420	34	47	20,5	46	50	30,40	FI-VSK-30S-W3
	1.18	6091	1.34	1.85	.81	1.81	1.97	76,20	
38	420	38	54	23	55	60	40,80	FI-VSK-38S-W3	
1.50	6091	1.54	2.13	.91	2.17	2.36	89,76		

<sup>1</sup> Approximate dimension in assembled condition.

<sup>2</sup> Weight excluding cutting ring and union nut.

<sup>3</sup> Standard scope of delivery: Blanking plug only.

0

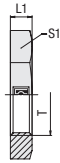

Hexagon Lock Nut  
 Type FI-SKM • Series L / S

for Straight Bulkhead Fittings / Bulkhead Elbows

Series	Dimensions		Weight ( <sup>kg</sup> / <sub>lbs</sub> ) ca. per 100	Ordering Codes	
	( <sup>mm</sup> / <sub>in</sub> ) Thread T	L1			S1
L	M 12 x 1,5	6	17	0,66	FI-SKM-06L-W3
		.24	.67	1.45	
	M 14 x 1,5	6	19	0,76	FI-SKM-08L/06S-W3
		.24	.75	1.67	
	M 16 x 1,5	6	22	1,04	FI-SKM-10L/08S-W3
		.24	.87	2.29	
	M 18 x 1,5	6	24	1,17	FI-SKM-12L/10S-W3
		.24	.94	2.62	
	M 22 x 1,5	7	30	2,25	FI-SKM-15L/14S-W3
		.28	1.18	4.95	
	M 26 x 1,5	8	36	3,75	FI-SKM-18L-W3
		.31	1.42	8.25	
	M 30 x 2	8	41	4,79	FI-SKM-22L/20S-W3
		.31	1.61	10.53	
M 36 x 2	9	46	5,90	FI-SKM-28L/25S-W3	
	.35	1.81	12.98		
M 45 x 2	9	55	7,60	FI-SKM-35L-W3	
	.35	2.17	16.72		
M 52 x 2	10	65	12,20	FI-SKM-42L/38S-W3	
	.39	2.56	26.84		
S	M 14 x 1,5	6	19	0,76	FI-SKM-08L/06S-W3
		.24	.75	1.67	
	M 16 x 1,5	6	22	1,04	FI-SKM-10L/08S-W3
		.24	.87	2.29	
	M 18 x 1,5	6	24	1,17	FI-SKM-12L/10S-W3
		.24	.94	2.57	
	M 20 x 1,5	6	27	1,54	FI-SKM-12S-W3
		.24	1.06	3.39	
	M 22 x 1,5	7	30	2,25	FI-SKM-15L/14S-W3
		.28	1.18	4.95	
	M 24 x 1,5	7	32	2,40	FI-SKM-16S-W3
		.28	1.26	5.28	
	M 30 x 2	8	41	4,79	FI-SKM-22L/20S-W3
		.31	1.61	10.54	
M 36 x 2	9	46	5,90	FI-SKM-28L/25S-W3	
	.35	1.81	12.98		
M 42 x 2	9	50	5,70	FI-SKM-30S-W3	
	.35	1.97	12.54		
M 52 x 2	10	65	12,20	FI-SKM-42L/38S-W3	
	.39	2.56	26.84		

## Ordering Codes

**\*FI-SKM\*-06\*L\*-W3**

* Hexagon Lock Nut for Bulkhead Fittings	FI-SKM
* Outside Tube Diameter D1 (in mm)	-06
* Series	Light Series      L Heavy Series      S
* Material Code	Steel, zinc/nickel-plated      -W3

Please contact STAUFF for alternative materials and surface finishings.



## Profile Sealing Ring for Male Studs Type WDG



### Whitworth Parallel Pipe Thread (BSPP)

Male stud acc. to ISO 1179-2 (Type E) / Port according to ISO 1179-1

Dimensions ( <sup>mm</sup> / <sub>in</sub> ) for Thread	D1	D2	L1	Ordering Codes	
				NBR (Buna-N®)	FKM (Viton®)
G 1/8	8,4	11,9	1	WDG-8.4x11.9x1-B90	WDG-8.4x11.9x1-V90
	.33	.47	.04		
G 1/4	11,6	16,5	1,5	WDG-11.6x16.5x1.5-B90	WDG-11.6x16.5x1.5-V90
	.46	.65	.06		
G 3/8	14,7	18,9	1,5	WDG-14.7x18.9x1.5-B90	WDG-14.7x18.9x1.5-V90
	.58	.74	.06		
G 1/2	18,5	23,9	1,5	WDG-18.5x23.9x1.5-B90	WDG-18.5x23.9x1.5-V80
	.73	.94	.06		
G 3/4	23,9	29,2	1,5	WDG-23.9x29.2x1.5-B90	WDG-23.9x29.2x1.5-V80
	.94	1.15	.06		
G 1	29,7	35,7	2	WDG-29.7x35.7x2-B90	WDG-29.7x35.7x2-V80
	1.17	1.41	.08		
G 1 1/4	38,8	45,8	2	WDG-38.8x45.8x2-B90	WDG-38.8x45.8x2-V80
	1.53	1.80	.08		
G 1 1/2	44,7	50,7	2	WDG-44.7x50.7x2-B90	WDG-44.7x50.7x2-V80
	1.76	2.00	.08		

### Metric Parallel Thread

Male stud according to ISO 9974-2 (Type E) / Port according to ISO 9974-1

Dimensions ( <sup>mm</sup> / <sub>in</sub> ) for Thread	D1	D2	L1	Ordering Codes	
				NBR (Buna-N®)	FKM (Viton®)
M 8 x 1	6,5	9,9	1	WDG-6.5x9.9x1-B90	WDG-6.5x9.9x1-V90
	.26	.39	.04		
M 10 x 1	8,4	11,9	1	WDG-8.4x11.9x1-B90	WDG-8.4x11.9x1-V90
	.33	.47	.04		
M 12 x 1,5	9,8	14,5	1,5	WDG-9.8x14.5x1.5-B90	WDG-9.8x14.5x1.5-V90
	.39	.57	.06		
M 14 x 1,5	11,6	16,5	1,5	WDG-11.6x16.5x1.5-B90	WDG-11.6x16.5x1.5-V90
	.46	.65	.06		
M 16 x 1,5	13,8	18,9	1,5	WDG-13.8x18.9x1.5-B80	WDG-13.8x18.9x1.5-V80
	.54	.74	.06		
M 18 x 1,5	15,7	20,9	1,5	WDG-15.7x20.9x1.5-B90	WDG-15.7x20.9x1.5-V80
	.62	.82	.06		
M 20 x 1,5	17,8	22,9	1,5	WDG-17.8x22.9x1.5-B90	WDG-17.8x22.9x1.5-V90
	.70	.90	.06		
M 22 x 1,5	19,6	24,3	1,5	WDG-19.6x24.3x1.5-B90	WDG-19.6x24.3x1.5-V90
	.77	.96	.06		
M 26 x 1,5	23,9	29,2	1,5	WDG-23.9x29.2x1.5-B90	WDG-23.9x29.2x1.5-V80
	.94	1.15	.06		
M 27 x 2	23,9	29,2	1,5	WDG-23.9x29.2x1.5-B90	WDG-23.9x29.2x1.5-V80
	.94	1.15	.06		
M 33 x 2	29,7	35,7	2	WDG-29.7x35.7x2-B90	WDG-29.7x35.7x2-V80
	1.17	1.41	.08		
M 42 x 2	38,8	45,8	2	WDG-38.8x45.8x2-B90	WDG-38.8x45.8x2-V80
	1.53	1.80	.08		
M 48 x 2	44,7	50,7	2	WDG-44.7x50.7x2-B90	WDG-44.7x50.7x2-V80
	1.76	2.00	.08		



O-Ring for Male Studs  
 Type O-RING

## Male stud according to ISO 6149-2/-3 / Port according to ISO 6149-1

## Metric Parallel Thread

Dimensions ( <sup>mm</sup> / <sub>in</sub> ) for Thread	Ordering Codes	
	NBR (Buna-N®)	FKM (Viton®)
M 8 x 1	O-RING-6.07x1.63-B90	O-RING-6.07x1.63-V90
M 10 x 1	O-RING-8.1x1.6-B90	O-RING-8.1x1.6-V90
M 12 x 1,5	O-RING-9.3x2.2-B90	O-RING-9.3x2.2-V90
M14 x 1,5	O-RING-11.3x2.2-B90	O-RING-11.3x2.2-V90
M16 x 1,5	O-RING-13.3x2.2-B90	O-RING-13.3x2.2-V90
M18 x 1,5	O-RING-15.3x2.2-B90	O-RING-15.3x2.2-V90
M22 x 1,5	O-RING-19.3x2.2-B90	O-RING-19.3x2.2-V90
M26 x 1,5	O-RING-23.3x2.4-B90	O-RING-23.3x2.4-V90
M27 x 2	O-RING-23.6x2.9-B90	O-RING-23.6x2.9-V90
M30 x 2	O-RING-26.62 x2.95-B90	O-RING-26.62 x2.95-V90
M33 x 2	O-RING-29.6x2.9-B90	O-RING-29.6x2.9-V90
M42 x 2	O-RING-38.6x2.9-B90	O-RING-38.6x2.9-V90
M48 x 2	O-RING-44.6x2.9-B90	O-RING-44.6x2.9-V90

## Male stud according to ISO 11926-2/-3 / Port according to ISO 11926-1

## UN / UNF Thread

Dimensions ( <sup>mm</sup> / <sub>in</sub> ) for Thread	Ordering Codes	
	NBR (Buna-N®)	FKM (Viton®)
7/16-20 UNF	O-RING-8.92x1.83-B90	O-RING-8.92x1.83-V90
1/2-20 UNF	O-RING-10.52x1.83-B90	O-RING-10.52x1.83-V90
9/16-18 UNF	O-RING-11.89x1.98-B90	O-RING-11.89x1.98-V90
3/4-16 UNF	O-RING-16.36x2.2-B90	O-RING-16.36x2.2-V90
7/8-14 UNF	O-RING-19.18x2.46-B90	O-RING-19.18x2.46-V 90
1 1/16-12 UN	O-RING-23.47x2.95-B90	O-RING-23.47x2.95-V80
1 3/16-12 UN	O-RING-26.62 x2.95-B90	O-RING-26.62 x 2.95-V90
1 5/16-12 UN	O-RING-29.74x2.95-B90	O-RING-29.74x2.95-V90
1 5/8-12 UN	O-RING-37.47x3-B90	O-RING-37.47x3-V90
1 7/8-12 UN	O-RING-43.69x3-B90	O-RING-43.69x3-V90

## Whitworth Parallel Pipe Thread (BSPP)

Dimensions ( <sup>mm</sup> / <sub>in</sub> ) for Thread	Ordering Codes	
	NBR (Buna-N®)	FKM (Viton®)
G 1/8	O-RING-7.97x1.88-B90	O-RING-7.97x1.88-V90
G 1/4	O-RING-10.77x2.62-B90	O-RING-10.77x2.62-V90
G 3/8	O-RING-13.94x2.62-B90	O-RING-13.94x2.62-V90
G 1/2	O-RING-17.86x2.62-B90	O-RING-17.86x2.62-V90
G 3/4	O-RING-23.47x2.62-B90	O-RING-23.47x2.62-V90
G 1	O-RING-29.74x3.53-B90	O-RING-29.74x3.53-V90
G 1 1/4	O-RING-37.69x3.53-B90	O-RING-37.69x3.53-V90
G 1 1/2	O-RING-44.04x3.53-B90	O-RING-44.04x3.53-V90



## O-Ring for 24°/37° Flared Cone Adaptors

### Type O-RING



#### 24° Taper of the Flared Cone Adaptor

Series	Tube OD (mm/in)	Ordering Codes	
		NBR (Buna-N®)	FKM (Viton®)
L	6	0-RING-4.5x1.5-B90	0-RING-4.5x1.5-V90
	.24		
	8	0-RING-6.5x1.5-B90	0-RING-6.5x1.5-V90
	.31		
	10	0-RING-8.5x1.5-B90	0-RING-8.5x1.5-V90
	.39		
	12	0-RING-10x1.5-B90	0-RING-10x1.5-V90
	.47		
	15	0-RING-12.5x2-B90	0-RING-12.5x2-V90
	.59		
	18	0-RING-16x2-B90	0-RING-16x2-V90
	.71		
	22	0-RING-20x2-B90	0-RING-20x2-V90
	.87		
	28	0-RING-26x2-B90	0-RING-26x2-V90
	1.10		
	35	0-RING-32x2.5-B90	0-RING-32x2.5-V90
1.38			
42	0-RING-38x2.5-B90	0-RING-38x2.5-V90	
1.65			
S	6	0-RING-4.5x1.5-B90	0-RING-4.5x1.5-V90
	.24		
	8	0-RING-6.5x1.5-B90	0-RING-6.5x1.5-V90
	.31		
	10	0-RING-8.5x1.5-B90	0-RING-8.5x1.5-V90
	.39		
	12	0-RING-10x1.5-B90	0-RING-10x1.5-V90
	.47		
	14	0-RING-12x2-B90	0-RING-12x2-V90
	.55		
	16	0-RING-14x2-B90	0-RING-14x2-V90
	.63		
	20	0-RING-17.3x2.4-B90	0-RING-17.3x2.4-V90
	.79		
	25	0-RING-22.3x2.4-B90	0-RING-22.3x2.4-V90
	.98		
	30	0-RING-27.3x2.4-B90	0-RING-27.3x2.4-V90
1.18			
38	0-RING-35x2.5-B90	0-RING-35x2.5-V90	
1.50			

0





## O-Ring for 24°/37° Flared Cone Adaptors Type O-RING



37° Taper of the Flared Cone Adaptor

Series	Tube OD (mm/in)	Ordering Codes	
		NBR (Buna-N®)	FKM (Viton®)
L	6	O-RING-4.4x0.8-B90	O-RING-4.4x0.8-V90
	.24		
	8	O-RING-6x0.8-B90	O-RING-6x0.8-V90
	.31		
	10	O-RING-7.5x0.8-B90	O-RING-7.5x0.8-V90
	.39		
	12	O-RING-9.5x0.8-B90	O-RING-9.5x0.8-V90
	.47		
	15	O-RING-12.5x0.8-B90	O-RING-12.5x0.8-V90
	.59		
	18	O-RING-15x1-B90	O-RING-15x1-V90
	.71		
	22	O-RING-18x1-B90	O-RING-18x1-V90
	.87		
	28	O-RING-23x1-B90	O-RING-23x1-V90
	1.10		
	35	O-RING-30x1-B90	O-RING-30x1-V90
1.38			
42	O-RING-37x1-B90	O-RING-37x1-V90	
1.65			
S	6	O-RING-4.4x0.8-B90	O-RING-4.4x0.8-V90
	.24		
	8	O-RING-6x0.8-B90	O-RING-6x0.8-V90
	.31		
	10	O-RING-7.5x0.8-B90	O-RING-7.5x0.8-V90
	.39		
	12	O-RING-9.5x0.8-B90	O-RING-9.5x0.8-V90
	.47		
	14	O-RING-11x1-B90	O-RING-11x1-V90
	.55		
	16	O-RING-12.5x1-B90	O-RING-12.5x1-V90
	.63		
	20	O-RING-16x1-B90	O-RING-16x1-V90
	.79		
	25	O-RING-20x1-B90	O-RING-20x1-V90
	.98		
	30	O-RING-25x1-B90	O-RING-25x1-V90
1.18			
38	O-RING-32x1.8-B90	O-RING-32x1.8-V90	
1.50			



## O-Ring for for DKO Taper Fittings / 24° Weld Cones Type O-RING



Series	Tube OD (mm/in)	Ordering Codes	
		NBR (Buna-N®)	FKM (Viton®)
L	6	0-RING-4.5x1.5-B90	0-RING-4.5x1.5-V90
	.24		
	8	0-RING-6.5x1.5-B90	0-RING-6.5x1.5-V90
	.31		
	10	0-RING-8.5x1.5-B90	0-RING-8.5x1.5-V90
	.39		
	12	0-RING-10x1.5-B90	0-RING-10x1.5-V90
	.47		
	15	0-RING-12.5x2-B90	0-RING-12.5x2-V90
	.59		
	18	0-RING-16x2-B90	0-RING-16x2-V90
	.71		
	22	0-RING-20x2-B90	0-RING-20x2-V90
	.87		
	28	0-RING-26x2-B90	0-RING-26x2-V90
	1.10		
35	0-RING-32x2.5-B90	0-RING-32x2.5-V90	
1.38			
42	0-RING-38x2.5-B90	0-RING-38x2.5-V90	
1.65			
S	6	0-RING-4.5x1.5-B90	0-RING-4.5x1.5-V90
	.24		
	8	0-RING-6.5x1.5-B90	0-RING-6.5x1.5-V90
	.31		
	10	0-RING-8.5x1.5-B90	0-RING-8.5x1.5-V90
	.39		
	12	0-RING-10x1.5-B90	0-RING-10x1.5-V90
	.47		
	14	0-RING-12x2-B90	0-RING-12x2-V90
	.55		
	16	0-RING-14x2-B90	0-RING-14x2-V90
	.63		
	20	0-RING-17.3x2.4-B90	0-RING-17.3x2.4-V90
	.79		
	25	0-RING-22.3x2.4-B90	0-RING-22.3x2.4-V90
	.98		
30	0-RING-27.3x2.4-B90	0-RING-27.3x2.4-V90	
1.18			
38	0-RING-35x2.5-B90	0-RING-35x2.5-V90	
1.50			

0



## O-Ring for Banjo Bolts of Banjo Fittings Type O-RING



Dimensions ( <sup>mm</sup> / <sub>in</sub> )		Ordering Codes	
for Thread	for Tube Size / Series	NBR (Buna-N®)	FKM (Viton®)
G 1/8	4LL / 6LL / 8LL / 6L	O-RING-8.5x1.5-B90	O-RING-8.5x1.5-V90
G 1/4	8L / 10L / 12L / 6S / 8S	O-RING-11x2-B90	O-RING-11x2-V90
G 3/8	12L / 10S / 12S	O-RING-14.5x2-B90	O-RING-14.5x2-V90
G 1/2	15L / 18L / 14S / 16S	O-RING-19.5x2-B90	O-RING-19.5x2-V90
G 3/4	22L / 20S	O-RING-26x1.5-B90	O-RING-26x1.5-V90
G 1	28L / 25S	O-RING-31x2-B90	O-RING-31x2-V90
G 1 1/4	35L / 30S	O-RING-40x2-B90	O-RING-40x2-V90
G 1 1/2	42L / 38S	O-RING-46x2-B90	O-RING-46x2-V90
M 8 x 1	4LL	O-RING-6.5x1.5-B90	O-RING-6.5x1.5-V90
M 10 x 1	6LL / 8LL / 6L	O-RING-8.5x1.5-B90	O-RING-8.5x1.5-V90
M 12 x 1,5	8L / 6S	O-RING-11x2-B90	O-RING-11x2-V90
M 14 x 1,5	10L / 8S / 12L	O-RING-11x2-B90	O-RING-11x2-V90
M 16 x 1,5	12L / 10S	O-RING-14.5x2-B90	O-RING-14.5x2-V90
M 18 x 1,5	12L / 10S	O-RING-14.5x2-B90	O-RING-14.5x2-V90
M 18 x 1,5	15L / 12S	O-RING-16.5x2-B90	O-RING-16.5x2-V90
M 20 x 1,5	14S	O-RING-19.5x2-B90	O-RING-19.5x2-V90
M 22 x 1,5	18L / 16S	O-RING-19.5x2-B90	O-RING-19.5x2-V90
M 26 x 1,5	22L	O-RING-26x1.5-B90	O-RING-26x1.5-V90
M 27 x 2	20S	O-RING-26x1.5-B90	O-RING-26x1.5-V90
M 33 x 2	28L / 25S	O-RING-31x2-B90	O-RING-31x2-V90
M 42 x 2	35L / 30S	O-RING-40x2-B90	O-RING-40x2-V90
M 48 x 2	42L / 38S	O-RING-46x2-B90	O-RING-46x2-V90



## External Metallic Sealing Ring for Male Studs of Banjo Fittings Type FI-DKR



Dimensions ( <sup>mm</sup> / <sub>in</sub> ) for Thread					Ordering Codes
		D1	D2	L1	
M 8 x 1		8,05	10,8	4	FI-DKR-M8x1-W3-WOB
		.32	.43	.16	
M 10 x 1	G 1/8	10,1	13	4	FI-DKR-M10x1-R1/8-W3-WOB
		.40	.51	.16	
M 12 x 1,5		12,2	17,8	4	FI-DKR-M12x1.5-W3-WOB
		.48	.70	.16	
	G 1/4	13,2	17,7	4	FI-DKR-R1/4-W3-WOB
		.52	.70	.16	
M 14 x 1,5		14,1	17,7	4,4	FI-DKR-M14x1.5-W3-WOB
		.56	.70	.17	
M 16 x 1,5		16,1	21,5	5	FI-DKR-M16x1.5-W3-WOB
		.63	.85	.20	
	G 3/8	16,7	22	5	FI-DKR-R3/8-W3-WOB
		.66	.87	.20	
M 18 x 1,5		18,1	23	5	FI-DKR-M18x1.5-W3-WOB
		.71	.91	.20	
	G 1/2	21	26	7	FI-DKR-18L/16S-R1/2-W3-WOB
		.83	1.02	.28	
M 20 x 1,5	G 1/2	21	26	5	FI-DKR-15L/14S-M20x1.5-R1/2-W3-WOB
		.83	1.02	.20	
M 22 x 1,5		22,1	27	7	FI-DKR-M22x1.5-W3-WOB
		.87	1.06	.28	
M 26 x 1,5		26,1	31,5	5,5	FI-DKR-M26x1.5-W3-WOB
		1.03	1.24	.22	
M 27 x 2	G 3/4	27,1	32	5,5	FI-DKR-M27x2-R3/4-W3-WOB
		1.07	1.26	.22	
M 33 x 2		33,3	39	5,5	FI-DKR-M33x2-R1-W3-WOB
		1.31	1.54	.22	
M 42 x 2	G 1 1/4	42,1	49	5,5	FI-DKR-M42x2-R1-1/4-W3-WOB
		1.66	1.93	.22	
M 48 x 2	G 1 1/2	48,1	55	5,5	FI-DKR-M48x2-R1-1/2-W3-WOB
		1.89	2.17	.22	



## Retaining Ring with Captive Seal for Male Studs of Banjo Fittings Type FI-DIR

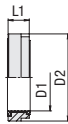

Dimensions ( <sup>mm</sup> / <sub>in</sub> ) for Thread						Ordering Codes
		Positioning	D1	D2	L1	
M 10 x 1	G 1/8	2	10,2 .40	14,9 .59	4,0 .16	FI-DIR-M10x1-R1/8-B-W3
M 12 x 1,5		1	12,2 .48	17,8 .70	4,0 .16	FI-DIR-M12x1.5-B-W3
	G 1/4	2	13,3 .52	18,8 .74	4,0 .16	FI-DIR-R1/4-B-W3
M 14 x 1,5		2	14,1 .56	19,9 .78	4,0 .16	FI-DIR-M14x1.5-B-W3
M 16 x 1,5	G 3/8	1	16,8 .66	22,8 .90	4,4 .17	FI-DIR-M16x1.5-R3/8-B-W3/2
M 18 x 1,5		1	18,1 .71	24,9 .98	5,0 .20	FI-DIR-M18x1.5-B-W3/2
M 18 x 1,5 (nur 12L)		1	18,1 .71	24,5 .96	4,6 .18	FI-DIR-12LM18x1.5-B-W3
	G 1/2 (nur 15L / 14S)	1	21 .83	27,9 1.1	5,0 .20	FI-DIR-15L/14S-R1/2-B-W3/2
	G 1/2 (nur 18L / 16S)	1	21 .83	27,9 1.1	7,0 .28	FI-DIR-18L/16S-R1/2-B-W3/2
M 20 x 1,5		1	20,2 .79	27,5 1.08	5,0 .20	FI-DIR-M20x1.5-B-W3
M 22 x 1,5		1	22,1 .87	27,9 1.1	7,0 .28	FI-DIR-M22x1.5-B-W3
M 26 x 1,5		1	26,1 1.03	32,5 1.28	5,5 .22	FI-DIR-M26x1.5-B-W3
M 27 x 2	G 3/4	1	27 1.06	32,9 1.3	5,5 .22	FI-DIR-M27x2-R3/4-B-W3/2
M 33 x 2	G 1	1	33,4 1.31	40,9 1.61	5,5 .22	FI-DIR-M33x2-R1-B-W3/2
M 42 x 2	G 1 1/4	1	42,1 1.66	50,9 2.0	5,5 .22	FI-DIR-M42x2-R1-1/4-B-W3
M 48 x 2	G 1 1/2	1	47,8 1.88	55,9 2.2	5,5 .22	FI-DIR-M48x2-R1-1/2-B-W3

### Positioning and Orientation (also see page 320)

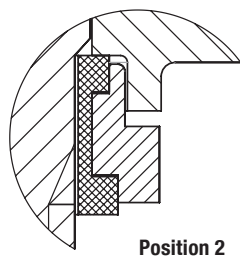
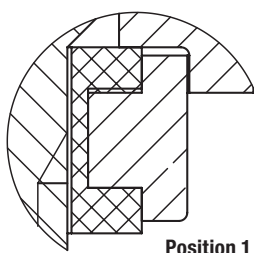

## Internal Metallic Sealing Ring for Female Studs of Gauge Fittings Type FI-DKI



Dimensions ( <sup>mm</sup> / <sub>in</sub> ) for Thread				Ordering Codes
	D1	D2	L1	
G 1/4	6	11,3	4,5	FI-DKI-R1/4-W3-W0B
	.24	.44	.18	
G 1/2	12	18,5	5	FI-DKI-R1/2-W3-W0B
	.47	.73	.20	



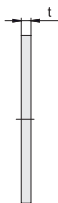
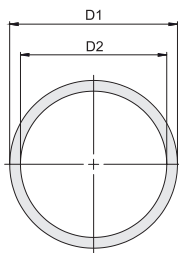

















Retaining Ring (Small) for Male Studs of Fittings with Lock Nut  
 Type FI-KR

Dimensions (mm/in) for Thread	D1	D2	t	Ordering Codes
G 1/8	14,8 .58	11,8 .46	1,4 .06	FI-KR-R1/8-W3-WOB
G 1/4	19,8 .78	16,15 .64	1,9 .07	FI-KR-R1/4-W3-WOB
G 3/8	22,8 .90	19,4 .76	1,9 .07	FI-KR-R3/8-W3-WOB
G 1/2	27,8 1.09	23,2 .91	1,9 .07	FI-KR-R1/2-W3-WOB
G 3/4	32,8 1.29	28,6 1.13	1,9 .07	FI-KR-R3/4-W3-WOB
G 1	40,8 1.61	36,6 1.44	2,6 .10	FI-KR-R1-W3-WOB
G 1 1/4	50,8 2.00	44,9 1.77	2,6 .10	FI-KR-R1-1/4-W3-WOB
G 1 1/2	55,8 2.20	50,9 2.00	2,6 .10	FI-KR-R1-1/2-W3-WOB
M 10 x 1	14,8 .58	11,4 .45	1,1 .04	FI-KR-M10x1-W3-WOB
M 12 x 1,5	17,8 .70	13,9 .55	1,7 .07	FI-KR-M12x1.5-W3-WOB
M 14 x 1,5	19,8 .78	15,9 .63	1,7 .07	FI-KR-M14x1.5-W3-WOB
M 16 x 1,5	22,8 .90	17,9 .70	1,7 .07	FI-KR-M16x1.5-W3-WOB
M 18 x 1,5	24,8 .98	19,9 .78	1,7 .07	FI-KR-M18x1.5-W3-WOB
M 22 x 1,5	27,8 1.09	23,9 .94	1,7 .07	FI-KR-M22x1.5-W3-WOB
M 27 x 2	32,8 1.29	29,6 1.17	2,2 .09	FI-KR-M27x2-W3-WOB
M 33 x 2	40,8 1.61	35,6 1.40	2,2 .09	FI-KR-M33x2-W3-WOB
M 42 x 2	50,8 2.00	44,6 1.76	2,2 .09	FI-KR-M42x2-W3-WOB
M 48 x 2	55,8 2.20	50,6 1.99	2,2 .09	FI-KR-M48x2-W3-WOB
7/16-20 UNF	17 .67	13 .51	1,3 .05	FI-KR-7/16U-W3-WOB
9/16-18 UNF	21 .83	16,1 .63	1,4 .06	FI-KR-9/16U-W3-WOB
3/4-16 UNF	26,5 1.04	21 .83	1,6 .06	FI-KR-3/4U-W3-WOB
7/8-14 UNF	30 1.18	24,3 .96	1,8 .07	FI-KR-7/8U-W3-WOB
1 1/16-12 UN	37,5 1.48	29,6 1.17	2,2 .09	FI-KR-1-1/16U-W3-WOB
1 5/16-12 UN	45 1.77	35,8 1.41	2,2 .09	FI-KR-1-5/16U-W3-WOB
1 5/8-12 UN	56,5 2.22	43,7 1.72	2,2 .09	FI-KR-1-5/8U-W3-WOB
1 7/8-12 UN	64 2.52	49,9 1.96	2,2 .09	FI-KR-1-7/8U-W3-WOB







	<b>Final Assembly Stud for the Manual Cutting Ring Assembly</b> FI-FK	250		<b>STAUFF Form EVO Tube Forming Machine</b> SFO-F	268
	<b>Pre-Assembly Stud for the Manual Cutting Ring Assembly</b> FI-VK	251		<b>Optional Cloud connection</b> SFO-F-IOT	272
	<b>Cutting Ring Final Assembly Machine</b> SPR-PRC-POC-A-A	252		<b>Tube Shapers</b> FI-FST	270
	<b>Cutting Ring Assembly Stud for Machine-Assisted Assembly</b> FI-MFK	254		<b>Internal Tube Supports</b> FI-ID	270
	<b>Support Plate for Machine-Assisted Assembly</b> FI-GP	255		<b>Clamping Jaws</b> FI-FB	271
	<b>Optional tool holder for tubes with small bending radii</b> SPR-PRC-POC-RTH	256		<b>Accessories</b>	272
	<b>Optional Cloud connection</b> SPR-PRC-POC-A-A-IOT	256			
	<b>Accessories</b>	256			
	<b>Cutting Ring Assembly and 37° Flaring Machine with Automatic / Manual Pressure Setting</b> SPR-PRC-MA-D-A	258			
	<b>Accessories</b>	260			
	<b>Cutting Ring Assembly Stud for Machine-Assisted Assembly</b> FI-MFK	261			
	<b>Support Plate for Machine-Assisted Assembly</b> FI-GP-PRC	262			
	<b>Clamping Jaws for 37° Flaring</b> FI-KB-PRC	263			
	<b>Portable Cutting Ring Assembly Machine with Manual Pressure Setting (Set)</b> SPR-PRC-H-SET	264			
	<b>Cutting Ring Assembly Stud for Machine-Assisted Assembly</b> FI-MVK-PRC-H-M	266			



**Final Assembly Stud for the Manual Cutting Ring Assembly**  
**Type FI-FK • Series LL / L / S**

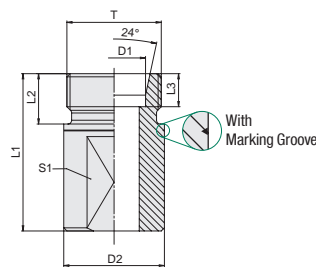

Series	Tube OD		Dimensions					Weight (#/lbs) ca. per 100	Ordering Codes	
	(mm/in)	(mm/in)	Thread T	D2	L1	L2	L3			S1
LL	4	M 8 x 1		14	40	8	4	11	3,74	FI-FK-04LL-HR
	.16			.55	1.57	.31	.16	.43	8.23	
	6	M 10 x 1		14	40	8	5,5	11	3,81	FI-FK-06LL-HR
	.24			.55	1.57	.31	.22	.43	8.39	
8	M 12 x 1		14	41	9	5,5	11	4,00	FI-FK-08LL-HR	
.31			.55	1.61	.35	.22	.43	8.81		
L	6	M 12 x 1,5		14	43	10	7	11	4,21	FI-FK-06L-HR
	.24			.55	1.69	.39	.28	.43	9.26	
	8	M 14 x 1,5		15	43	10	7	12	4,96	FI-FK-08L-HR
	.31			.59	1.69	.39	.28	.47	10.90	
	10	M 16 x 1,5		17	44	11	7	14	6,57	FI-FK-10L-HR
	.39			.67	1.73	.43	.28	.55	14.46	
	12	M 18 x 1,5		20	44	11	7	17	9,06	FI-FK-12L-HR
	.47			.79	1.73	.43	.28	.67	19.92	
	15	M 22 x 1,5		23	45	12	7	19	12,34	FI-FK-15L-HR
	.59			.91	1.77	.47	.28	.75	27.14	
	18	M 26 x 1,5		29	46	12	7,5	24	19,62	FI-FK-18L-HR
	.71			1.14	1.81	.47	.30	.94	43.16	
	22	M 30 x 2		32	48	14	7,5	27	25,11	FI-FK-22L-HR
	.87			1.26	1.89	.55	.30	1.06	55.23	
	28	M 36 x 2		38	48	14	7,5	32	35,07	FI-FK-28L-HR
	1.10			1.50	1.89	.55	.30	1.26	77.15	
35	M 45 x 2		48	60	16	10,5	41	69,87	FI-FK-35L-HR	
1.38			1.89	2.36	.63	.41	1.61	153.71		
42	M 52 x 2		54	60	16	11	46	87,41	FI-FK-42L-HR	
1.65			2.13	2.36	.63	.43	1.81	192.31		
S	6	M 14 x 1,5		15	45	12	7	12	5,34	FI-FK-06S-HR
	.24			.59	1.77	.47	.28	.47	11.75	
	8	M 16 x 1,5		17	45	12	7	14	6,92	FI-FK-08S-HR
	.31			.67	1.77	.47	.28	.55	15.23	
	10	M 18 x 1,5		20	45	12	7,5	17	9,44	FI-FK-10S-HR
	.39			.79	1.77	.47	.30	.67	20.78	
	12	M 20 x 1,5		22	45	12	7,5	17	10,87	FI-FK-12S-HR
	.47			.87	1.77	.47	.30	.67	23.92	
	14	M 22 x 1,5		24	47	14	8	19	13,59	FI-FK-14S-HR
	.55			.94	1.85	.55	.31	.75	29.90	
	16	M 24 x 1,5		27	48	14	8,5	22	17,49	FI-FK-16S-HR
	.63			1.06	1.89	.55	.33	.87	38.48	
	20	M 30 x 2		32	50	16	10,5	27	25,83	FI-FK-20S-HR
	.79			1.26	1.97	.63	.41	1.06	56.82	
25	M 36 x 2		38	62	18	12	32	46,15	FI-FK-25S-HR	
.98			1.50	2.44	.71	.47	1.26	101.54		
30	M 42 x 2		44	64	20	13,5	36	62,34	FI-FK-30S-HR	
1.18			1.73	2.52	.79	.53	1.42	137.15		
38	M 52 x 2		54	66	22	16	46	95,92	FI-FK-38S-HR	
1.50			2.13	2.60	.87	.63	1.81	211.03		

Materials / surface finishings: HR Steel, uncoated, hardened

**Accessories**



Cone Gauges

Page 277

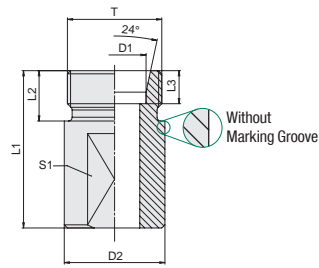

**Pre-Assembly Stud for the Manual Cutting Ring Assembly  
Type FI-VK - Series LL / L / S**

Series	Tube OD		Dimensions					Weight (kg/lbs) ca. per 100	Ordering Codes
	(mm/in)	(mm/in)	D1	Thread T	D2	L1	L2		
LL	4	M 8 x 1	14	25	8	4,3	11	2,11	FI-VK-04LL-HR
	.16		.55	.98	.31	.17	.43	4,64	
	6	M 10 x 1	14	25	8	5,8	11	2,18	FI-VK-06LL-HR
.24	.55		.98	.31	.23	.43	4,79		
LL	8	M 12 x 1	14	26	9	5,8	11	2,36	FI-VK-08LL-HR
	.31		.55	1.02	.35	.23	.43	5,20	
L	6	M 12 x 1,5	14	28	10	7,3	11	2,57	FI-VK-06L-HR
	.24		.55	1.10	.39	.29	.43	5,66	
	8	M 14 x 1,5	15	28	10	7,3	12	3,05	FI-VK-08L-HR
	.31		.59	1.10	.39	.29	.47	6,71	
	10	M 16 x 1,5	17	29	11	7,3	14	4,07	FI-VK-10L-HR
	.39		.67	1.14	.43	.29	.55	8,96	
	12	M 18 x 1,5	20	29	11	7,3	17	5,53	FI-VK-12L-HR
	.47		.79	1.14	.43	.29	.67	12,16	
	15	M 22 x 1,5	23	30	12	7,3	19	7,75	FI-VK-15L-HR
	.59		.91	1.18	.47	.29	.75	17,04	
	18	M 26 x 1,5	29	31	12	7,8	24	12,31	FI-VK-18L-HR
	.71		1.14	1.22	.47	.31	.94	27,08	
	22	M 30 x 2	32	33	14	7,8	27	16,08	FI-VK-22L-HR
	.87		1.26	1.30	.55	.31	1.06	35,38	
	28	M 36 x 2	38	33	14	7,8	32	22,34	FI-VK-28L-HR
	1.10		1.50	1.30	.55	.31	1.26	49,15	
	35	M 45 x 2	48	45	16	10,8	41	49,40	FI-VK-35L-HR
	1.38		1.89	1.77	.63	.43	1.61	108,67	
42	M 52 x 2	54	45	16	11,3	46	61,50	FI-VK-42L-HR	
1.65		2.13	1.77	.63	.44	1.81	135,31		
S	6	M 14 x 1,5	15	30	12	7,3	12	3,43	FI-VK-06S-HR
	.24		.59	1.18	.47	.29	.47	7,55	
	8	M 16 x 1,5	17	30	12	7,3	14	4,43	FI-VK-08S-HR
	.31		.67	1.18	.47	.29	.55	9,75	
	10	M 18 x 1,5	20	30	12	7,8	17	5,92	FI-VK-10S-HR
	.39		.79	1.18	.47	.31	.67	13,03	
	12	M 20 x 1,5	22	30	12	7,8	17	6,87	FI-VK-12S-HR
	.47		.87	1.18	.47	.31	.67	15,11	
	14	M 22 x 1,5	24	32	14	8,3	19	8,74	FI-VK-14S-HR
	.55		.94	1.26	.55	.33	.75	19,23	
	16	M 24 x 1,5	27	33	14	8,8	22	11,23	FI-VK-16S-HR
	.63		1.06	1.30	.55	.35	.87	24,70	
	20	M 30 x 2	32	35	16	10,8	27	16,83	FI-VK-20S-HR
	.79		1.26	1.38	.63	.43	1.06	37,02	
	25	M 36 x 2	38	47	18	12,3	32	33,47	FI-VK-25S-HR
.98	1.50		1.85	.71	.48	1.26	73,63		
30	M 42 x 2	44	49	20	13,8	36	45,62	FI-VK-30S-HR	
1.18		1.73	1.93	.79	.54	1.42	100,37		
38	M 52 x 2	54	51	22	16,3	46	70,08	FI-VK-38S-HR	
1.50		2.13	2.01	.87	.64	1.81	154,17		

 Materials / surface finishings: **HR Steel**, uncoated, hardened

**P**

## STAUFF Press Cutting Ring Final Assembly Machine Type SPR-PRC-POC-A-A



### Product Description

The STAUFF Press Assembly Machine SPR-PRC-POC-A-A allows the pressure/position-controlled final assembly of cutting rings from the Extra-Light Series (LL), the Light Series (L) and the Heavy Series (S) according to ISO 8434-1 / DIN 2353 on tube ends with outer diameters between 4 mm and 42 mm.

The machine is designed as a robust table-top device for continuous operation in the workshop. It is used in connection with hardened and wear-resistant assembly studs FI-FMK and support plates FI-GP which are specially designed for the machine-assisted assembly.

The combined pressure/position-control of the device allows wear on the assembly tools to be detected in time before it can have a negative influence on the assembly result. Maximum service life of the tools is achieved through careful handling of the components and practical operation of the assembly machine. Other factors are proper storage (protected against contamination and corrosion), regular cleaning and lubrication (with suitable lubricants) and thorough preparation of the tube ends before assembly (cutting, deburring and cleaning).

Short times for tool changes, setup and assembly make it possible to carry out series assembly of cutting rings as well as assembly of small and medium quantities with a high level of economic efficiency, reproducibility and process reliability. Among other things, this is achieved with the RFID transponders – which are integrated into the support plates for automatic tool size identification as a standard – and with the tool contact switch: this allows assembly processes to be automatically started and completed by simply pushing the tube end into the assembly stud without having to press any buttons. The assembly area is secured against interference by a light grid to comply with current accident prevention regulations.

With machine-assisted **final assembly**, the cutting ring has already cut 100% into the tube and the fitter only has to tighten the union nut by 30° (corresponds to 1/12 turns) from the fix point. Please pay attention to the corresponding assembly instruction.

Final assembly (100%) minimises the risk for errors (insufficient or excessive manual tightening) and the resulting leak potentials which can often lead to time consuming and expensive machine downtimes and environmental impact. Due to the time benefits during final tightening, final assembly by machine also generates clear saving potentials compared to manual direct assembly as well as to machine-assisted pre-assembly.

In case of incorrect or incomplete assembly where pressure and position parameters significantly deviate from the values stored in the machine, it automatically stops the assembly process and displays a corresponding warning message on the operating panel.



Operating elements of the assembly machine



Noise-reducing tool tray with durable rubber mat



Electrical connection plug and Ethernet port (RJ45)



Lateral handle bars and rubber machine feet with suitable clearance height

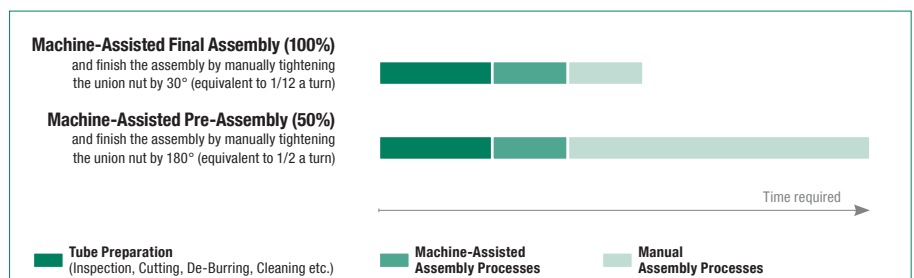

Comparison of the total times required for the assembly and installation of cutting ring connections (medium size)

P



## STAUFF Press Cutting Ring Final Assembly Machine Type SPR-PRC-POC-A-A

### Characteristics

#### Performance

- final assembly (100 %)
- Short times for tool changes, setup and assembly
- Tool size detection via RFID transponders in the support plates
- Automatic assembly start through integrated tool contact switch
- Tool wear detection through combined pressure/position-control
- Internal memory for up to 9 assembly programs which can be selected on the operating panel: predefined are tube materials steel E235 and E355 as well as stainless steel 316; parameters for other materials (copper, CuNiFe, Tungum, polyamide etc.) can be added by the manufacturer if required
- Counters for lot/batch sizes and total quantities (separated by tool size)
- Documented process control through programmable logic control (PLC)
- Predefined menu languages: English, German, French and Italian
- Manual pressure adjustment possible

#### Design

- ① Robust and ergonomically designed machine housing
- ② Optimised assembly area, which allows processing of tubes with low bending radii (to at least 31 mm / 1.22 in distance from the tube axis to the interfering edge of the machine housing) or complex geometries
- ③ Noise-reducing tool tray with durable rubber mat
- ④ Lateral handle bars as attachment points for transport (e.g. with lifting belts)
- ⑤ Secure positioning thanks to flexible rubber machine feet
- ⑥ Type plate, with technical data, serial number, year of manufacture, etc.

### Technical Data

#### Area of Application

- Function: final assembly (100%) of cutting rings on metric tube ends
- Operating principle: Assembly with combined pressure/position-control
- Series and diameters: Extra-Light Series (LL): 4, 6, 8, 10, 12 mm  
Light Series (L): 6, 8, 10, 12, 15, 18, 22, 28, 35, 42 mm  
Heavy Series (S): 6, 8, 10, 12, 14, 16, 20, 25, 30, 38 mm

#### Dimensions / Weight

- Dimensions (W x D x H): 780 mm x 650 mm x 305 mm  
30.70 in x 25.29 in x 12.00 in  
with lateral handle bars (detachable)
- Distance from the tube axis to the interfering edge of the machine housing: 80 mm / 3.15 in
- Clearance height: 65 mm / 2.56 in (height of the machine feet)  
enables simple and safe transport using a forklift or pallet jack
- Weight: 95 kg / 210 lbs (incl. operating fluid, excl. assembly tools)

#### Materials

- Machine frame: Aluminium
- Machine housing: Steel, painted
- Tool tray: NBR (Perbunan®)
- Machine feet: Natural rubber
- Assembly studs: Steel, PVD coated
- Support plates: Steel, browned

#### Operating Elements

- ⑦ Operating panel for display and selection of all relevant settings and assembly parameters
- ⑧ Button for definite confirmation of entries made on the operating panel
- ⑨ Status light to indicate readiness for operation and running assembly processes

#### Safety Devices

- ⑩ Main power switch (can be secured against unauthorised actuation when required)
- ⑪ Separate emergency stop button to immediately stop all machine movements
- ⑫ Light grid to protect users when reaching into the assembly area

#### Connections (at the back of the machine)

- ⑬ Electrical connection according to IEC 60309 CEE 16A (cable length: 4 m / 13.12 ft) and Ethernet connection (RJ45) for maintenance and data input by the manufacturer

#### Assembly Tools

- ⑭ Wear-resistant assembly stud FI-MFK
- ⑮ Support plate FI-GP with RFID transponder

#### Motor Configuration

- Power supply: 400 V AC @ 50 Hz - 3 phases  
460 V AC @ 60 Hz - 3 phases
- Current consumption: 2,7 A
- Connected load: 0,9 kW
- Electrical connection: Phase reversing plug according to IEC 60309 CEE 16A
- Cable length: 4 m / 13.12 ft

Alternative motor configurations and plug types are available on request. Please contact STAUFF for details.

#### Hydraulic System

- Operating fluid: Hydraulic oil Shell Tellus S2 MA 46 or equivalent (filled and ready for operation when delivered)
- Fluid volume: 4 litres / 1.06 US Gallon
- Max working pressure: 450 bar / 6527 PSI

#### Operating Conditions

- Storage temperature: -10°C ... +70°C / +14°F ... +158°F
- Ambient temperature: +15°C ... +35°C / +59°F ... +95°F
- Ambient conditions: Dry, no condensing humidity, operation in horizontal position only
- Noise emission: less than 66 dB(A) as per EN ISO 11202 at full-load operation with maximum tube dimensions



#### STAUFF Maintenance Contracts

Please contact STAUFF for a maintenance contract, that provides optimum service for your STAUFF assembly machine.



#### STAUFF Machine Rental

Please contact STAUFF for a rental machine and further details of what this service can offer.



### Cutting Ring Assembly Stud for Machine-Assisted Assembly Type FI-MFK ▪ Series LL / L / S

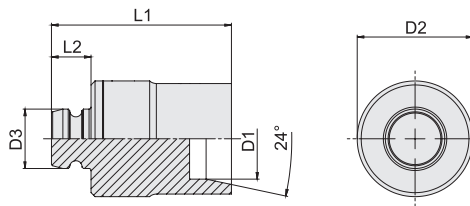

Series	Tube OD		Dimensions			Weight ( <sup>kg</sup> /lbs) ca. per 100	Ordering Codes
	D1 (mm/in)	D2 (mm/in)	D3	L1	L2		
LL	4	30	14,8	50	10	12,98	FI-MFK-04LL-W100
	.16	1.18	.58	1.97	.39	28.55	
	6	30	14,8	50	10	13,28	FI-MFK-06LL-W100
	.24	1.18	.58	1.97	.39	29.22	
	8	30	14,8	50	10	13,68	FI-MFK-08LL-W100
	.31	1.18	.58	1.97	.39	30.10	
L	6	30	14,8	50	10	13,57	FI-MFK-06L-W100
	.24	1.18	.58	1.97	.39	29.85	
	8	30	14,8	50	10	14,01	FI-MFK-08L-W100
	.31	1.18	.58	1.97	.39	30.82	
	10	30	14,8	50	10	14,63	FI-MFK-10L-W100
	.39	1.18	.58	1.97	.39	32.18	
	12	30	14,8	50	10	16,09	FI-MFK-12L-W100
	.47	1.18	.58	1.97	.39	35.39	
	15	30	14,8	50	10	16,63	FI-MFK-15L-W100
	.59	1.18	.58	1.97	.39	36.58	
	18	30	14,8	50	10	18,23	FI-MFK-18L-W100
	.71	1.18	.58	1.97	.39	40.10	
	22	30	14,8	49	10	19,13	FI-MFK-22L-W100
	.87	1.18	.58	1.93	.39	42.08	
	28	33,8	14,8	48	10	24,43	FI-MFK-28L-W100
	1.10	1.33	.58	1.89	.39	53.74	
	35	42,8	14,8	45	10	32,72	FI-MFK-35L-W100
1.38	1.69	.58	1.77	.39	71.99		
42	49,8	14,8	44	10	41,17	FI-MFK-42L-W100	
1.65	1.96	.58	1.73	.39	90.58		
S	6	30	14,8	50	10	14,14	FI-MFK-06S-W100
	.24	1.18	.58	1.97	.39	31.11	
	8	30	14,8	50	10	14,68	FI-MFK-08S-W100
	.31	1.18	.58	1.97	.39	32.29	
	10	30	14,8	50	10	15,23	FI-MFK-10S-W100
	.39	1.18	.58	1.97	.39	33.51	
	12	30	14,8	50	10	15,89	FI-MFK-12S-W100
	.47	1.18	.58	1.97	.39	34.95	
	14	30	14,8	49	10	15,98	FI-MFK-14S-W100
	.55	1.18	.58	1.93	.39	35.15	
	16	30	14,8	49	10	16,65	FI-MFK-16S-W100
	.63	1.18	.58	1.93	.39	36.64	
	20	30	14,8	45	10	16,43	FI-MFK-20S-W100
	.79	1.18	.58	1.77	.39	36.15	
	25	33,8	14,8	42	10	19,02	FI-MFK-25S-W100
	.98	1.33	.58	1.65	.39	41.84	
	30	39,8	14,8	40	10	22,88	FI-MFK-30S-W100
1.18	1.57	.58	1.57	.39	50.34		
38	49,8	14,8	36	10	26,41	FI-MFK-38S-W100	
1.50	1.96	.58	1.42	.39	58.10		

Materials / surface finishings: W100 Steel, PVD coated

#### Accessories



Cone Gauges

Page 277

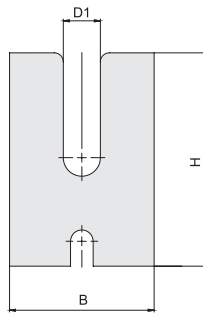
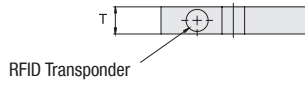

Support Plate for Machine-Assisted Assembly  
 Type FI-GP • Series LL / L / S

Series	Tube OD	Dimensions			Weight ( <sup>kg</sup> / <sub>lbs</sub> ) ca. per 100	Ordering Codes
	( <sup>mm</sup> / <sub>in</sub> ) D1	( <sup>mm</sup> / <sub>in</sub> ) B	H	T		
LL	4	80	118	15	104,43	FI-GP-04LL-W101
	.16	3.15	4.65	.59	229.75	
	6	80	118	15	102,97	FI-GP-06LL-W101
	.24	3.15	4.65	.59	226.53	
	8	80	118	15	101,46	
	.31	3.15	4.65	.59	223.22	FI-GP-08LL-W101
L	6	80	118	15	102,97	FI-GP-06L-W101
	.24	3.15	4.65	.59	226.53	
	8	80	118	15	101,46	FI-GP-08L-W101
	.31	3.15	4.65	.59	223.22	
	10	80	118	15	99,93	FI-GP-10L-W101
	.39	3.15	4.65	.59	219.84	
	12	80	118	15	98,35	FI-GP-12L-W101
	.47	3.15	4.65	.59	216.37	
	15	80	118	15	95,91	FI-GP-15L-W101
	.59	3.15	4.65	.59	211.01	
	18	80	118	15	93,40	FI-GP-18L-W101
	.71	3.15	4.65	.59	205.47	
	22	80	118	15	89,91	FI-GP-22L-W101
	.87	3.15	4.65	.59	197.80	
	28	80	118	15	84,41	FI-GP-28L-W101
	1.10	3.15	4.65	.59	185.69	
	35	80	118	15	77,56	FI-GP-35L-W101
	1.38	3.15	4.65	.59	170.64	
	42	80	118	15	70,27	FI-GP-42L-W101
	1.65	3.15	4.65	.59	154.59	
S	6	80	118	15	102,97	FI-GP-06S-W101
	.24	3.15	4.65	.59	226.53	
	8	80	118	15	101,46	FI-GP-08S-W101
	.31	3.15	4.65	.59	223.22	
	10	80	118	15	99,93	FI-GP-10S-W101
	.39	3.15	4.65	.59	219.84	
	12	80	118	15	98,35	FI-GP-12S-W101
	.47	3.15	4.65	.59	216.37	
	14	80	118	15	96,73	FI-GP-14S-W101
	.55	3.15	4.65	.59	212.81	
	16	80	118	15	95,08	FI-GP-16S-W101
	.63	3.15	4.65	.59	209.18	
	20	80	118	15	91,67	FI-GP-20S-W101
	.79	3.15	4.65	.59	201.68	
	25	80	118	15	87,20	FI-GP-25S-W101
	.98	3.15	4.65	.59	191.84	
	30	80	118	15	82,50	FI-GP-30S-W101
	1.18	3.15	4.65	.59	181.49	
38	80	118	15	74,49	FI-GP-38S-W101	
1.50	3.15	4.65	.59	163.88		

 Materials / surface finishings: **W101** Steel, browned

P



**STAUFF Press**  
**Optional tool holder for tubes with small bending radii**  
**Type SPR-PRC-POC-RTH**



The assembly head differs from the standard model by the holder for the cutting ring assembly socket being moved upwards, shortening the distance from the tube axis in the assembly socket to the upper edge of the machine from the standard 77 mm to 31 mm.

This means that cutting rings can be fitted with ease to tubes with small axis distances.

If tubes with complex geometries are to be handled (e.g. with short tube end and 90° tail), the safety light barrier, which secures the assembly area, can be disabled if required.

The optional assembly head enables tubes with a diameter of 6 to 18 mm in the Light Series and 6 mm to 16 mm in the Heavy Series to be handled.

Existing assembly tools can also continue to be used. The user simply needs to import new parameter sets into the machine.

**STAUFF Press**  
**Optional Cloud connection allows preventive maintenance via remote access and facilitates the documentation of assembly processes**  
**Type SPR-PRC-POC-A-A-IOT**



Cutting ring assembly machines type SPR-PRC-POC can be equipped at the factory with a built-in module for direct connection to a cloud operated by STAUFF. This solution is realised with an integrated SIM card which can be used in all industrial regions of the world.

This enables software updates, for example, without having to connect the machine to a local network on site. Parameter sets, which have been determined by STAUFF for non-standard tube materials can also be transferred quickly and directly to the machine in this way.

Customers are given access to the cloud via a protected online portal, where they can get detailed information on the assembly processes performed, among other things.

The required data security is guaranteed by encryption in both directions.

P

**Assembly Tool Magazine**  
**Type SPR-TM**



- Provides safe and convenient storage for up to 10 assembly studs (type FI-MFK) as well as up to 10 support plates (types FI-GP and FI-GP-PRC) for the machine-assisted cutting ring assembly
- Assembly studs and support plates are not included in the scope of delivery for this item and have to be ordered separately

**External Foot Control Switch**  
**Type SFO/PRC-POC-FS**



- Enables the operator to trigger assembly processes from a larger distance to the machine (cable length: 5 m / 16.40 ft)





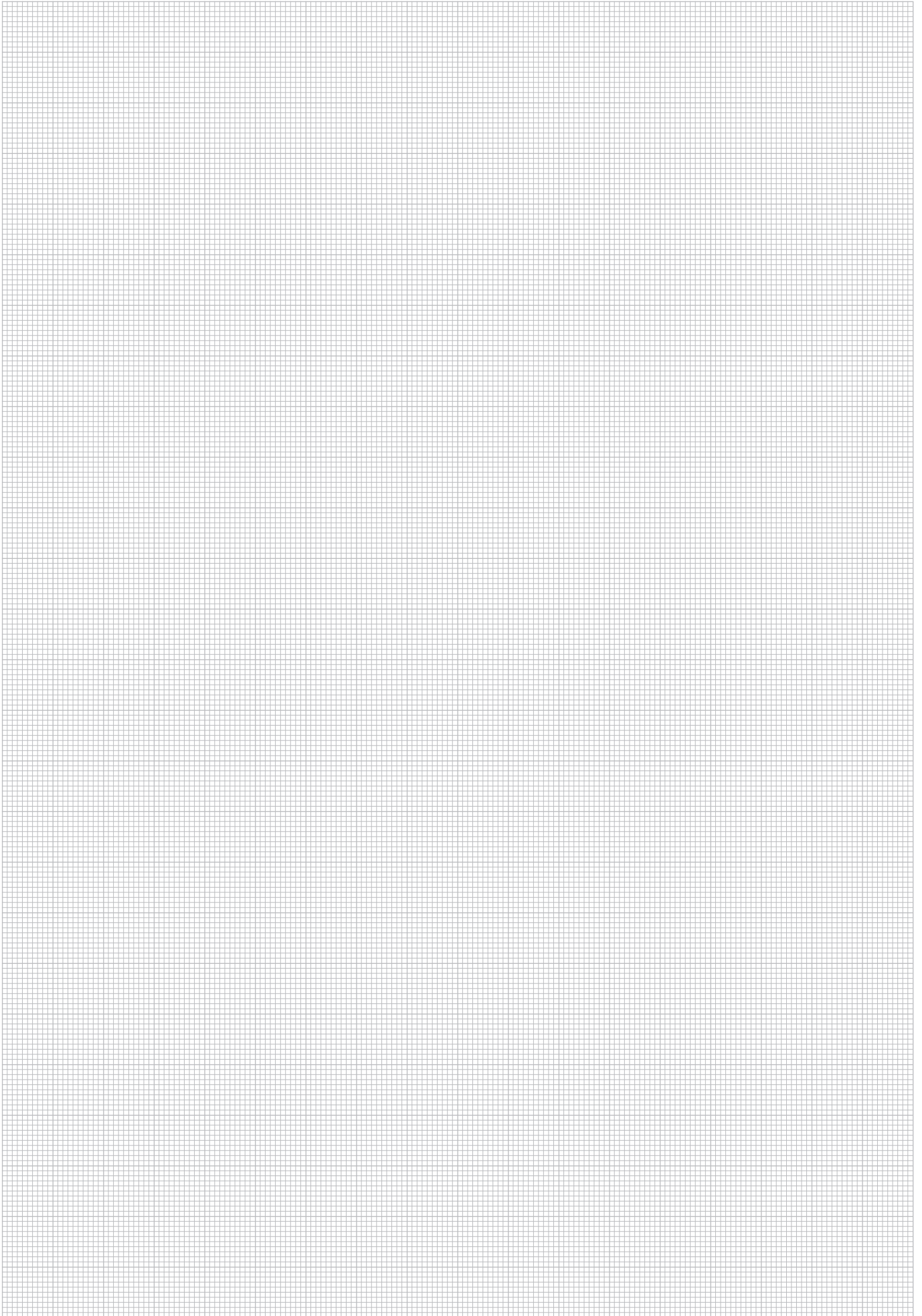

P



## STAUFF Press Combined Cutting Ring Assembly and 37° Tube Flaring Machine with Automatic or Manual Pressure Setting and Control ▪ Type SPR-PRC-MA-D-A

### Product Description

The electro-hydraulically operated STAUFF Press Assembly Machine SPR-PRC-MA-D-A allows the assembly of cutting rings in the Light Series (L) as well as in the Heavy Series (S) according to ISO 8434-1 / DIN 2353 on metric tube ends with outer diameters from 4 mm to 42 mm.

Exchangeable heads allows the device to be adapted for 37° flaring of metric and imperial tube ends with outer diameters from 4 mm and from 1/4 in to 1 1/2 in respectively according to DIN 3949 or SAE J514 / ISO 8434-2.

Short times for tool changes, setup and assembly (even when changing the assembly type from cutting ring assembly to 37° tube flaring) make it possible to carry out series production as well as the assembly of small and medium quantities with a high level of economic efficiency, reproducibility and process reliability with considerable reduction of times and cost of assembly of fittings.

The adjustable return stroke of the cylinder helps the operator to further optimise the total cycle times.

The machine is designed as a robust table-top device for continuous operation in the workshop. It is used in connection with hardened and wear-resistant assembly tools which are specially designed for the machine-assisted assembly.



Tooling head for cutting ring assembly based on pre-defined settings / automatic tool size detection



Tooling head for cutting ring assembly based on settings manually defined by the operator



Tooling head for 37° tube flaring based on settings manually defined by the operator



Smart programmable control panel with push/turn button and back-lit parameter display



Noise-reducing tool tray with durable rubber mat



Robust rubber feet providing secure positioning and dampening during operation



USB connection for maintenance and data input by the manufacturer



Electrical connection with a phase reversing plug according to IEC 60309 CEE 16A



Connections for the tool head as well as for the external foot control switch

P



## STAUFF Press

# Combined Cutting Ring Assembly and 37° Tube Flaring Machine with Automatic or Manual Pressure Setting and Control ▪ Type SPR-PRC-MA-D-A

### Characteristics

#### Performance

- Pressure-controlled assembly of cutting rings on metric tube ends as well as 37° tube flaring of metric/imperial tube ends due to exchangeable tool heads
- Cutting ring assembly with Tooling Head SPR-PRC-TH-C-MA based on pre-defined pressure settings (with automatic tool size detection) or with Tooling Head SPR-PRC-TH-C-M based on pressure settings as manually defined by the operator
- Short times for tool and head changes, setup and assembly (even when changing the assembly type from cutting ring assembly to 37° tube flaring)
- Adjustable return stroke of the cylinder in order to further optimise the total cycle times
- Internal memory for up to 8 assembly programs which can be selected on the operating panel: predefined are tube materials steel E235 and E355 as well as stainless steel 316; parameters for other materials (copper, CuNiFe, Tungum, polyamide etc.) can be added by the manufacturer if required
- Counters for lot/batch sizes and total quantities
- Operator-friendly and easy to maintain and service

#### Design

- ① Robust and compact table-top device allowing for maximum mobility and flexibility
- ② Optimised assembly area with approx. 65 mm / 2.56 in distance from the tube axis to the interfering edge of the machine housing, which allows processing of tubes with low bending radii or complex geometries
- ③ Noise-reducing tool tray with durable rubber mat
- ④ Lateral handle bars as attachment points for transport (e.g. with lifting belts)
- ⑤ Robust rubber feet providing secure positioning and dampening during operation
- ⑥ Type plate, with technical data, serial number, year of manufacture, etc.

### Technical Data

#### Area of Application

- Function: Pressure-controlled assembly of cutting rings  
Light (L): 6, 8, 10, 12, 15, 18, 22, 28, 35, 42 mm  
Heavy (S): 6, 8, 10, 12, 14, 16, 20, 25, 30, 38 mm
- Pressure-controlled 37° flaring of metric tube ends (according to DIN 3949 bzw. SAE J 514 / ISO 8434-2):  
Light (L): from 6 x 1 mm to 42 x 4 mm  
Heavy (S): from 6 x 1 mm to 38 x 5 mm
- Pressure-controlled 37° flaring of imperial tube ends (according to SAE J 514 / ISO 8434-2):  
1/4, 5/16, 3/8, 1/2, 5/8, 3/4, 7/8, 1, 1-1/4, 1-1/2 inch

#### Dimensions / Weight

- Dimensions (W x D x H): 660 mm x 515 mm x 265 mm  
25.98 in x 20.28 in x 10.43 in  
with lateral handle bars (detachable)
- Distance from the tube axis to the interfering edge of the machine housing: 65 mm / 2.56 in
- Clearance height: 30 mm / 1.18 in (height of the machine feet)
- Weight (basic machine): 66 kg / 145 lbs  
(incl. operating fluid, excl. assembly tools)
- Weight (tooling heads): SPR-PRC-TH-C-A: 6,0 kg / 13 lbs  
SPR-PRC-TH-C-M: 5,5 kg / 12 lbs  
SPR-PRC-TH-F-M: 19,5 kg / 43 lbs

#### Materials

- Machine frame: Steel
- Machine cover: Plastic
- Tool tray: NBR (Perbunan®)
- Machine feet: Natural rubber
- Assembly tools: Steel, uncoated, hardened

#### Operating Elements

- ⑦ Push/turn control button to select all relevant settings and assembly parameters
- ⑧ Smart programmable control panel with back-lit parameter display
- ⑨ Button for definite confirmation of entries made on the operating panel
- ⑩ Illuminated pushbutton to reset the cylinder and to indicate incorrect assemblies

#### Safety Devices

- ⑪ Selector switch to choose the operation mode (can be locked with a key and secured against unauthorised actuation, if required)
- ⑫ Main power switch
- ⑬ Separate emergency stop button to immediately stop all machine movements

#### Connections

- ⑭ Electrical connection according to IEC 60309 CEE 16A (cable length: 4 m / 13.12 ft)
- ⑮ USB connection for maintenance and data input by the manufacturer
- ⑯ Connections for tool heads for cutting ring assembly based on pre-defined pressure settings as well as for the external foot control switch SPR-PRC-FS (available on request)

#### Assembly Tools

- Tooling head SPR-PRC-TH-C-MA for cutting ring assembly based on automatic pressure setting (50% pre-assembly is pre-defined) and with tool size detection via the support plates
- Tooling head SPR-PRC-TH-C-M for cutting ring assembly based on manual settings
- Tooling head SPR-PRC-TH-F-M for 37° tube flaring based on manual settings
- Wear-resistant cutting ring assembly stud FI-MFK
- Support plate FI-GP-...-PRC
- Clamping jaws FI-KB-...-PRC for 37° tube flaring

#### Motor Configuration

- Power supply: 400 V AC @ 50 Hz - 3 phases
- Current consumption: 2,8 A
- Connected load: 1,2 kW
- Electrical connection: Phase reversing plug according to IEC 60309 CEE 16A
- Cable length: 4 m / 13.12 ft

Alternative motor configurations and plug types are available on request. Please contact STAUFF for details.

#### Hydraulic System

- Operating fluid: Hydraulic oil Shell Nuto H 32 or equivalent (filled and ready for operation when delivered)
- Fluid volume: 4 litres / .78 US Gallon
- Max working pressure: 200 bar / 2901 PSI

#### Operating Conditions

- Storage temperature: -10°C ... +70°C / +14°F ... +158°F
- Ambient temperature: +10°C ... +50°C / +50°F ... +122°F
- Ambient conditions: Dry, no condensing humidity, operation in horizontal position only
- Noise emission: less than 60 dB(A) as per EN ISO 11202



#### STAUFF Maintenance Contracts

Please contact STAUFF for a maintenance contract, that provides optimum service for your STAUFF assembly machine.



#### STAUFF Machine Rental

Please contact STAUFF for a rental machine and further details of what this service can offer.



**Tooling Head for Cutting Ring Assembly (based on pre-defined settings)**  
**Type SPR-PRC-TH-C-MA**



- Tooling head SPR-PRC-TH-C-MA for cutting ring pre-assembly based on pre-defined settings and with automatic tool size detection via the support plates
- Requires cutting ring assembly studs FI-MFK and support plates FI-GP-PRC

**Tooling Head for Cutting Ring Assembly (based on manual settings)**  
**Type SPR-PRC-TH-C-M**



- Tooling head SPR-PRC-TH-C-M for cutting ring pre-assembly based on manual settings
- Requires cutting ring assembly studs FI-MFK and support plates FI-GP-PRC

**Tooling Head for 37° Tube Flaring (based on manual settings)**  
**Type SPR-PRC-TH-F-M**



- Tooling head SPR-PRC-TH-F-M for 37° tube flaring based on manual settings
- Requires clamping jaws FI-KB-PRC

P

**Assembly Tool Magazine**  
**Type SPR-TM**



- Provides safe and convenient storage for up to 10 assembly studs (type FI-MFK) as well as up to 10 support plates (types FI-GP and FI-GP-PRC) for the machine-assisted cutting ring assembly
- Assembly studs and support plates are not included in the scope of delivery for this item and have to be ordered separately

**External Foot Control Switch**  
**Type SPR-PRC-FS**



- Enables the operator to trigger assembly processes from a larger distance to the machine (cable length: 5 m / 16.40 ft)



## Cutting Ring Assembly Stud for Machine-Assisted Assembly Type FI-MFK • Series LL / L / S

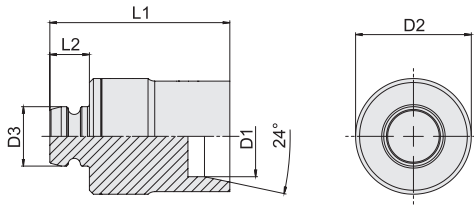

Series	Tube OD		Dimensions			Weight (% / lbs) ca. per 100	Ordering Codes		
	(mm / in)	(mm / in)	D1	D2	D3				
LL	4	30			14,8	50	10	12,98	FI-MFK-04LL-W100
	.16	1.18			.58	1.97	.39	28.55	
	6	30			14,8	50	10	13,28	FI-MFK-06LL-W100
	.24	1.18			.58	1.97	.39	29.22	
	8	30			14,8	50	10	13,68	
	.31	1.18			.58	1.97	.39	30.10	FI-MFK-08LL-W100
L	6	30			14,8	50	10	13,57	FI-MFK-06L-W100
	.24	1.18			.58	1.97	.39	29.85	
	8	30			14,8	50	10	14,01	FI-MFK-08L-W100
	.31	1.18			.58	1.97	.39	30.82	
	10	30			14,8	50	10	14,63	FI-MFK-10L-W100
	.39	1.18			.58	1.97	.39	32.18	
	12	30			14,8	50	10	16,09	FI-MFK-12L-W100
	.47	1.18			.58	1.97	.39	35.39	
	15	30			14,8	50	10	16,63	FI-MFK-15L-W100
	.59	1.18			.58	1.97	.39	36.58	
	18	30			14,8	50	10	18,23	FI-MFK-18L-W100
	.71	1.18			.58	1.97	.39	40.10	
	22	30			14,8	49	10	19,13	FI-MFK-22L-W100
	.87	1.18			.58	1.93	.39	42.08	
	28	33,8			14,8	48	10	24,43	FI-MFK-28L-W100
	1.10	1.33			.58	1.89	.39	53.74	
	35	42,8			14,8	45	10	32,72	FI-MFK-35L-W100
	1.38	1.69			.58	1.77	.39	71.99	
	42	49,8			14,8	44	10	41,17	FI-MFK-42L-W100
	1.65	1.96			.58	1.73	.39	90.58	
S	6	30			14,8	50	10	14,14	FI-MFK-06S-W100
	.24	1.18			.58	1.97	.39	31.11	
	8	30			14,8	50	10	14,68	FI-MFK-08S-W100
	.31	1.18			.58	1.97	.39	32.29	
	10	30			14,8	50	10	15,23	FI-MFK-10S-W100
	.39	1.18			.58	1.97	.39	33.51	
	12	30			14,8	50	10	15,89	FI-MFK-12S-W100
	.47	1.18			.58	1.97	.39	34.95	
	14	30			14,8	49	10	15,98	FI-MFK-14S-W100
	.55	1.18			.58	1.93	.39	35.15	
	16	30			14,8	49	10	16,65	FI-MFK-16S-W100
	.63	1.18			.58	1.93	.39	36.64	
	20	30			14,8	45	10	16,43	FI-MFK-20S-W100
	.79	1.18			.58	1.77	.39	36.15	
	25	33,8			14,8	42	10	19,02	FI-MFK-25S-W100
	.98	1.33			.58	1.65	.39	41.84	
	30	39,8			14,8	40	10	22,88	FI-MFK-30S-W100
	1.18	1.57			.58	1.57	.39	50.34	
38	49,8			14,8	36	10	26,41	FI-MFK-38S-W100	
1.50	1.96			.58	1.42	.39	58.10		

Materials / surface finishings: W100 Steel, PVD coated

### Accessories



Cone Gauges

Page 277



**Support Plate for Machine-Assisted Cutting Ring Assembly**  
**Type FI-GP-PRC • Series L / S**



Series	Tube OD (mm/in)	Ordering Codes
L	6	FI-GP-06L/S-PRC-MA-W1
	.24	
	8	FI-GP-08L/S-PRC-MA-W1
	.31	
	10	FI-GP-10L/S-PRC-MA-W1
	.39	
	12	FI-GP-12L/S-PRC-MA-W1
	.47	
	15	FI-GP-15L-PRC-MA-W1
	.59	
	18	FI-GP-18L-PRC-MA-W1
	.71	
	22	FI-GP-22L-PRC-MA-W1
	.87	
	28	FI-GP-28L-PRC-MA-W1
	1.10	
	35	FI-GP-35L-PRC-MA-W1
1.38		
42	FI-GP-42L-PRC-MA-W1	
1.65		
S	6	FI-GP-06L/S-PRC-MA-W1
	.24	
	8	FI-GP-08L/S-PRC-MA-W1
	.31	
	10	FI-GP-10L/S-PRC-MA-W1
	.39	
	12	FI-GP-12L/S-PRC-MA-W1
	.47	
	14	FI-GP-14S-PRC-MA-W1
	.55	
	16	FI-GP-16S-PRC-MA-W1
	.63	
	20	FI-GP-20S-PRC-MA-W1
	.79	
	25	FI-GP-25S-PRC-MA-W1
	.98	
	30	FI-GP-30S-PRC-MA-W1
1.18		
38	FI-GP-38S-PRC-MA-W1	
1.50		

Materials / surface finishings: **W1** Steel, uncoated, hardened

P



Clamping Jaws for 37° Tube Flaring  
 Type FI-KB • Series L / S

## 37° Flaring of Metric Tube Ends

Series	Tube OD (mm/in)	Ordering Codes	
		DIN 3949	SAE J514 / ISO 8434-2
L	6	FI-KB-06L/S-PRC-MF-W1	FI-KB-06-PRC-F-W1
	.24		
	8	FI-KB-08L/S-PRC-MF-W1	FI-KB-08/5/16-PRC-F-W1
	.31		
	10	FI-KB-10L/S-PRC-MF-W1	FI-KB-10-PRC-F-W1
	.39		
	12	FI-KB-12L/S-PRC-MF-W1	FI-KB-12-PRC-F-W1
	.47		
	15	FI-KB-15L-PRC-MF/F-W1	
	.59		
	18	FI-KB-18L-PRC-MF/F-W1	
	.71		
	22	FI-KB-22L-PRC-MF/F-W1	
	.87		
	28	FI-KB-28L-PRC-MF-W1	FI-KB-28-PRC-F-W1
	1.10		
	35	FI-KB-35L-PRC-MF-W1	FI-KB-35-PRC-F-W1
1.38			
42	FI-KB-42L-PRC-MF-W1	FI-KB-42-PRC-F-W1	
1.65			
S	6	FI-KB-06L/S-PRC-MF-W1	FI-KB-06-PRC-F-W1
	.24		
	8	FI-KB-08L/S-PRC-MF-W1	FI-KB-08/5/16-PRC-F-W1
	.31		
	10	FI-KB-10L/S-PRC-MF-W1	FI-KB-10-PRC-F-W1
	.39		
	12	FI-KB-12L/S-PRC-MF-W1	FI-KB-12-PRC-F-W1
	.47		
	14	FI-KB-14S-PRC-MF/F-W1	
	.55		
	16	FI-KB-16S-PRC-MF-W1	FI-KB-16-PRC-F-W1
	.63		
	20	FI-KB-20S-PRC-MF-W1	FI-KB-20-PRC-F-W1
	.79		
	25	FI-KB-25S-PRC-MF-W1	FI-KB-25-PRC-F-W1
	.98		
	30	FI-KB-30S-PRC-MF/F-W1	
	1.18		
	30 x 5	FI-KB-30SX5-PRC-MF-W1	
	1.18 x .20		
38	FI-KB-38S-PRC-MF-W1	FI-KB-38-1-1/2-PRC-F-W1	
1.50			
38 x 5	FI-KB-38SX5-PRC-MF-W1		
1.50 x .20			

## 37° Flaring of Imperial Tube Ends

Tube OD (mm/in)	Ordering Codes
	SAE J514 / ISO 8434-2
1/4	FI-KB-1/4-PRC-F-W1
5/16	FI-KB-08/5/16-PRC-F-W1
3/8	FI-KB-3/8-PRC-F-W1
1/2	FI-KB-1/2-PRC-F-W1
5/8	FI-KB-5/8-PRC-F-W1
3/4	FI-KB-3/4-PRC-F-W1
7/8	FI-KB-7/8-PRC-F-W1
1	FI-KB-1-PRC-F-W1
1-1/4	FI-KB-1-1/4-PRC-F-W1
1-1/2	FI-KB-38-1-1/2-PRC-F-W1

 Materials / surface finishings: **W1** Steel, uncoated, hardened

## STAUFF Press Portable Cutting Ring Assembly Machine with Manual Pressure Setting (Set) Type SPR-PRC-H-SET

### Product Description

With the battery-operated STAUFF Press Assembly Machine SPR-PRC-H-M, STAUFF provides an ergonomically designed, light-weight and at the same time robust device for the assembly of cutting rings in the Light Series (L) as well as in the Heavy Series (S) according to ISO 8434-1 / DIN 2353 on metric tube ends with outer diameters from 6 mm to 42 mm.

The machine has been designed for hand-held, tripod- or table-mounted operation and offers the best technical compromise between maximum flexibility, economic efficiency and a high level of process reliability with considerable reduction of time and cost for the assembly of cutting ring fittings.

Short tool change and setup times (with only a few seconds required to manually adjust the assembly pressure) make it possible to carry out the assembly of medium and even small quantities of cutting ring fittings, e.g. during maintenance, servicing, conversion and repair works on hydraulic pipe and tube systems. With the rechargeable battery being able to typically cover more than 200 assembly cycles per charge (depending on pressure settings and other influencing factors), the machine is also suitable for mass processing and production.

The assembly machine is by default supplied in a heavy-duty trolley transport case that is equipped with a range of accessories and also provides suitable space for the assembly studs.



Mode dial to manually adjust the pressure (settings indicated on the machine housing)



Status lights on the back of the machine housing



Assembly machine attached to a tripod stand using a mounting bracket



P





## STAUFF Press Portable Cutting Ring Assembly Machine with Manual Pressure Setting (Set) Type SPR-PRC-H-SET

### Technical Data

#### Area of Application

- Function: Pressure-controlled assembly of cutting rings acc. to ISO 8434-1 / DIN 2353 on metric tube ends  
Light (L): 6, 8, 10, 12, 15, 18, 22, 28, 35 and 42 mm  
Heavy (S): 6, 8, 10, 12, 14, 16, 20, 25, 30 and 38 mm

#### Dimensions / Weight

- Dimensions (L x H x W): 440 mm x 330 mm x 80 mm  
17.32 in x 12.99 in x 3.15 in  
(including rechargeable battery)
- Weight (basic machine): 6,8 kg / 15 lbs  
(including rechargeable battery)
- Weight (case): 16,5 kg / 36 lbs  
(including assembly machine and accessories)
- Case: IP67 certified, equipped with o-ring seal and automatic pressure valve

#### Materials

- Machine cover: Plastic
- Tool head: Steel, uncoated, hardened
- Assembly studs: Stainless steel, hardened

### List of Components

#### Set supplied in a heavy-duty trolley transport case:

- ① Light-weight and ergonomically designed cutting ring assembly machine for the hand-held, tripod-mounted or table-mounted operation
- ② Rechargeable battery
- ③ Additional replacement battery
- ④ Battery quick charging unit
- ⑤ Clips (to keep the assembly stud in position)

Not displayed: Shoulder strap

#### Equipment to be ordered separately:

- ⑥ Assembly oil with brush (to lubricate the taper of the assembly stud)
- ⑦ Cutting Ring Assembly Studs **FI-MVK-PRC-H-M-HR**

#### Spare Parts

- Assembly oil with brush **SPR-PRC-H-M-OS**  
(required to lubricate the taper of the assembly stud)
- Rechargeable Battery **SPR-PRC-H-M-BP**
- Battery Quick Charging Unit **SPR-PRC-H-M-BC**

#### Rechargeable Battery

- Typically covers more than 200 assembly cycles per charge (depending on pressure settings and other influencing factors)
- Battery type: Lithium-ion (18V / 3.0 Ah)

#### Charging Unit

- Charging time for empty batteries is approximately 75 minutes
- Power supply: 230 V AC @ 50 Hz - single-phase
- Electrical connection: 2-pin grounded safety plug (CEE 7/4, type F / Schuko)
- Cable length: 1,10 m / 3.61 ft

#### Accessories



- Tripod Stand **SPR-PRC-H-M-TP**



- Table Stand **SPR-PRC-H-M-TS**



- Mounting Bracket **SPR-PRC-H-M-MH**  
(required as a machine holder for both the tripod stand and the table stand)



**Cutting Ring Assembly Stud for Machine-Assisted Assembly**  
**Type FI-MVK-PRC-H-M ▪ Series L / S**



Series	Tube OD (mm/in)	Ordering Codes
L	6	FI-MVK-06L-PRC-H-M-HR
	.24	
	8	FI-MVK-08L-PRC-H-M-HR
	.31	
	10	FI-MVK-10L-PRC-H-M-HR
	.39	
	12	FI-MVK-12L-PRC-H-M-HR
	.47	
	15	FI-MVK-15L-PRC-H-M-HR
	.59	
	18	FI-MVK-18L-PRC-H-M-HR
	.71	
	22	FI-MVK-22L-PRC-H-M-HR
	.87	
	28	FI-MVK-28L-PRC-H-M-HR
	1.10	
	35	FI-MVK-35L-PRC-H-M-HR
1.38		
42	FI-MVK-42L-PRC-H-M-HR	
1.65		
S	6	FI-MVK-06S-PRC-H-M-HR
	.24	
	8	FI-MVK-08S-PRC-H-M-HR
	.31	
	10	FI-MVK-10S-PRC-H-M-HR
	.39	
	12	FI-MVK-12S-PRC-H-M-HR
	.47	
	14	FI-MVK-14S-PRC-H-M-HR
	.55	
	16	FI-MVK-16S-PRC-H-M-HR
	.63	
	20	FI-MVK-20S-PRC-H-M-HR
	.79	
	25	FI-MVK-25S-PRC-H-M-HR
	.98	
	30	FI-MVK-30S-PRC-H-M-HR
1.18		
38	FI-MVK-38S-PRC-H-M-HR	
1.50		

Materials / surface finishing: **HR** Stainless steel, hardened

P



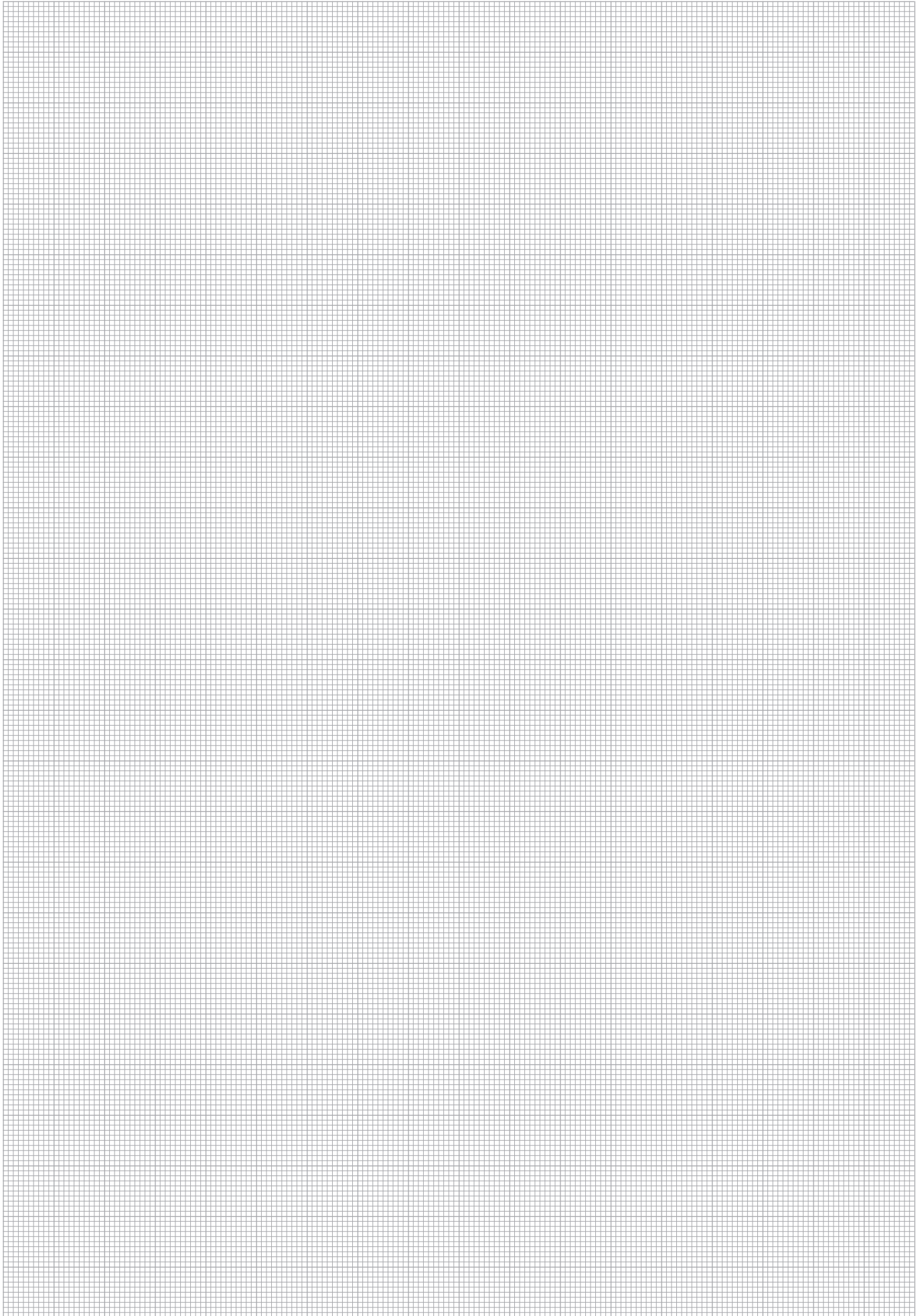

P



## STAUFF Form EVO Tube Forming Machine Type SFO-F-A-A



### Product Description

The type SFO-F-A-A tube forming machine facilitates the economical and most reliable production of tube ends made of steel, stainless steel and other materials with a contour typical for the STAUFF Form EVO tube forming system.

The machine is designed as a robust table-top device for continuous operation in the workshop. It is used in connection with FI-FST tube shapers and FI-FB clamping jaws. Tube shapers with FI-ID internal tube supports are used with selected tube dimensions, which prevent the tube from being constricted in the shaping area.

Tube shapers, clamping jaws and internal tube supports have been specifically designed for the mechanical forming process and can be quickly and simply replaced without the need for any tools, if required. The resulting short tool change and set-up times contribute to the high efficiency of the system as well as ensuring low cycle times.

All the tools needed for the forming process are clearly labelled with the tube dimensions so that assembly errors caused by incorrect assignment can be largely ruled out.

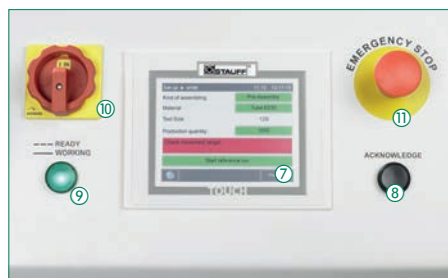

Operating elements of the tube forming machine



Noise-reducing tool tray with durable rubber mat



Lateral handle bars and rubber machine feet with suitable clearance height

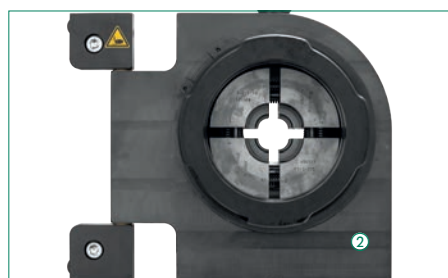

Open clamping head with clamping jaws inserted



Inserting the tube shaper into the tool holder – with no tools required



Electrical connections

## Optional Cloud connection allows preventive maintenance via remote access and facilitates the documentation of assembly processes Type SFO-F-IOT



Tube forming machines type SFO-F-A-A can be equipped at the factory with a built-in module for direct connection to a cloud operated by STAUFF. This solution is realised with an integrated SIM card which can be used in all industrial regions of the world.

This enables software updates, for example, without having to connect the machine to a local network on site. Parameter sets, which have been determined by STAUFF for non-standard tube materials can also be transferred quickly and directly to the machine in this way.

Customers are given access to the cloud via a protected online portal, where they can get detailed information on the assembly processes performed, among other things.

The required data security is guaranteed by encryption in both directions.



## STAUFF Form EVO Tube Forming Machine Type SFO-F-A-A

### Characteristics

#### Performance

- Constant high process safety, reliability and reproducibility by the position-control of the machine, which performs the shaping process following a manual start and monitors it by means of stored parameters
- Maximum efficiency thanks to short cycle times – ideal for series production
- Quick and simple replacement of tube shapers (with bayonet lock) and clamping jaws when changing the tube dimensions – with no tools required
- Potential risk of confusion and assembly errors caused by incorrect assignment can virtually be ruled out by the clear labelling of all assembly tools
- Surface-friendly clamping of the tube during the forming process
- Counters for lot/batch sizes and total quantities (separated by tool size)
- Predefined menu languages: English, German, French and Italian
- High degree of user comfort with clear information displayed on the operating panel

#### Design

- ① Robust and ergonomically designed machine housing
- ② Easily accessible clamping head for simple positioning of the clamping jaws and optimised assembly area with approx. 110 mm / 4.33 in distance from the tube axis to the interfering edge of the machine housing, which allows processing of tubes with low bending radii or complex geometries
- ③ Noise-reducing tool tray with durable rubber mat
- ④ Lateral handle bars as attachment points for transport (e.g. with lifting belts)
- ⑤ Secure positioning thanks to flexible rubber machine feet
- ⑥ Type plate, with technical data, serial number, year of manufacture etc.

### Technical Data

#### Area of Application

- **Function:** Cold forming of seamless cold drawn precision steel tubes acc. to EN 10305-1 (materials E235, E355) and stainless steel tubes (material 1.4571 / AISI 316 Ti)

Parameters for alternative materials can be added by the manufacturer, if required. Please contact STAUFF for details.

- **Operating principle:** Tube forming with combined pressure/position-control
- **Series and dimensions:** Light Series (L): 6 x 1,5 mm to 42 x 4 mm  
Heavy Series (S): 6 x 1,5 mm to 38 x 6 mm

#### Dimensions / Weight

- **Dimensions (W x D x H):** 850 mm x 890 mm x 330 mm  
33.46 in x 35.04 in x 12.99 in  
with lateral handle bars (detachable)
- **Distance from the tube axis to the interfering edge of the machine housing:** 110 mm / 4.33 in
- **Clearance height:** 65 mm / 2.56 in (height of the machine feet)  
enables simple and safe transport using a forklift or pallet jack
- **Weight:** 210 kg / 463 lbs  
(including operating fluid, excluding forming tools)

#### Materials

- **Machine frame:** Aluminium
- **Machine housing:** Steel, painted
- **Tool tray:** NBR (Perbunan®)
- **Machine feet:** Natural rubber
- **Form rings:** Steel, zinc/nickel-plated
- **Form rings (seal):** FKM (Viton®)

#### Operating Elements

- ⑦ Operating panel for display and selection of all relevant settings and forming parameters
- ⑧ Button for definite confirmation of entries made on the operating panel
- ⑨ Status light to indicate readiness for operation and running assembly processes

#### Safety Devices

- ⑩ Main power switch  
(can be secured against unauthorised actuation when required)
- ⑪ Separate emergency stop button to immediately stop all machine movements

#### Connections (at the back of the machine)

- ⑫ Electrical connection according to IEC 60309 CEE 16A  
(cable length: 4 m / 13.12 ft)
- ⑬ Connection for External Foot Control Switch Type SFO/PRC-POC-FS
- ⑭ Ethernet connection (RJ45)  
for maintenance and data input by the manufacturer
- ⑮ Aerial IoT Gateway for preventive maintenance via remote access and facilitates the documentation of assembly processes

#### Tube Forming Tools

- ⑯ Clamping Jaws FI-FB with clear identification of the tube dimension
- ⑰ Version of a Tube Shaper FI-FST with Internal Tube Support FI-ID
- ⑱ Tube Shaper FI-FST with clear identification of the tube dimensions

#### Motor Configuration

- **Power supply:** 400 V AC @ 50 Hz - 3 phases  
460 V AC @ 60 Hz - 3 phases
- **Current consumption:** 2,55 A
- **Connected load:** 1,0 kW
- **Electrical connection:** Phase reversing plug  
according to IEC 60309 CEE 16A
- **Cable length:** 4 m / 13.12 ft

Alternative motor configurations and plug types are available on request. Please contact STAUFF for details.

#### Hydraulic System

- **Operating fluid:** Hydraulic oil Shell Tellus S2 MA 46 or equivalent  
(filled and ready for operation when delivered)
- **Fluid volume:** 6,1 litres / 1.61 US Gallon
- **Max working pressure:** 700 bar / 10153 PSI

#### Operating Conditions

- **Storage temperature:** -10°C ... +70°C / +14°F ... +158°F
- **Ambient temperature:** +15°C ... +35°C / +59°F ... +95°F
- **Ambient conditions:** Dry, no condensing humidity,  
operation in horizontal position only  
less than 69 dB(A) as per EN ISO 11202  
at full-load operation with maximum tube dimensions
- **Noise emission:**



#### STAUFF Maintenance Contracts

Please contact STAUFF for a maintenance contract, that provides optimum service for your STAUFF Tube Forming Machine.



#### STAUFF Machine Rental

Please contact STAUFF for a rental machine and further details of what this service can offer.



**STAUFF Form EVO Tube Shapers ▪ Type FI-FST**  
**STAUFF Form EVO Internal Tube Supports ▪ Type FI-ID**



Tube OD		Tube Wall Thickness		Weight per piece		Ordering Codes	
(mm)	(in)	(mm)	(in)	(kg) ca.	(lbs) ca.	Tube Shapers	Internal Tube Supports
6	.24	1,5	.06	1,95	4.29	FI-FST-06L/S-F2-S-A	
8	.31	1,5	.06	1,97	4.33	FI-FST-08L/S-F2-S-A	
		2,0	.08				
10	.39	1,5	.06	1,98	4.36	FI-FST-10L/S-F2-S-A	
		2,0	.08				
		2,5	.10				
		3,0	.12				
12	.47	1,5	.06	1,99	4.38	FI-FST-12L/S-1.5-F2-S-A	FI-ID-12x1.5-HR/2
		2,0	.08			FI-FST-12L/S-2/2.5/3-F2-S-A	
		2,5	.10				
		3,0	.12				
15	.59	1,5	.06	2,0	4.40	FI-FST-15L-F2-S-A	FI-ID-15x1.5-HR/2
		2,0	.08				FI-ID-15x2.0-HR/2
		2,5	.10				FI-ID-15x2.5-HR/2
16	.63	2,0	.08	2,04	4.49	FI-FST-16S-2/2.5-F2-S-A	FI-ID-16x2.0-HR/2
		2,5	.10			FI-FST-16S-3/4-F2-S-A	FI-ID-16x2.5-HR/2
		3,0	.12				
		4,0	.16				
18	.71	1,5	.06	1,97	4.33	FI-FST-18L-2/2.5-F2-S-A	FI-ID-18x1.5-HR/2
		2,0	.08				FI-ID-18x2.0-HR/2
		2,5	.10				FI-ID-18x2.5-HR/2
		3,0	.12				
20	.79	2,0	.08	1,98	4.36	FI-FST-20S-2/2.5-F2-S-A	FI-ID-20x2.0-HR/2
		2,5	.10			FI-FST-20S-3/3.5/4-F2-S-A	FI-ID-20x2.5-HR/2
		3,0	.12				
		4,0	.16				
22	.87	2,0	.08	1,95	4.29	FI-FST-22L-2/2.5-F2-S-A	FI-ID-22x2.0-HR/2
		2,5	.10			FI-FST-22L-3/3.5-F2-S-A	FI-ID-22x2.5-HR/2
		3,0	.12				
		3,5	.14				
25	.98	2,0	.08	1,96	4.31	FI-FST-25S-2/2.5-F2-S-A	FI-ID-25x2.0-HR/2
		2,5	.10			FI-FST-25S-3/3.5/4/5-F2-S-A	FI-ID-25x2.5-HR/2
		3,0	.12				
		3,5	.14				
		4,0	.16				
5,0	.20						
28	1.10	2,0	.08	1,96	4.31	FI-FST-28L-2/2.5/3-F2-S-A	FI-ID-28x2.0-HR/2
		2,5	.10			FI-FST-28L-3.5/4-F2-S-A	FI-ID-28x2.5-HR/2
		3,0	.12				FI-ID-28x3.0-HR/2
		3,5	.14				
		4,0	.16				
30	1.18	2,5	.10	1,95	4.29	FI-FST-30S-2.5/3-F2-S-A	FI-ID-30x2.5-HR/2
		3,0	.12			FI-FST-30S-4/5/6-F2-S-A	FI-ID-30x3.0-HR/2
		4,0	.16				
		5,0	.20				
		6,0	.24				
35	1.38	2,5	.10	2,0	4.40	FI-FST-35L-2.5/3-F2-S-A	FI-ID-35x2.5-HR/2
		3,0	.12			FI-FST-35L-4/5-F2-S-A	FI-ID-35x3.0-HR/2
		4,0	.16				
		5,0	.20				
38	1.50	3,0	.12	1,82	4.00	FI-FST-38S-3/4-F2-S-A	FI-ID-38x3.0-HR/2
		4,0	.16			FI-FST-38S-5/6-F2-S-A	FI-ID-38x4.0-HR/2
		5,0	.20				
		6,0	.24				
42	1.65	3,0	.12	1,94	4.27	FI-FST-42L-F2-S-A	FI-ID-42x3.0-HR/2
		3,5	.14				FI-ID-42x3.5-HR/2
		4,0	.16				FI-ID-42x4.0-HR/2

Materials / surface finishings: HR Steel, uncoated, hardened

Please note:

The selection chart is only applicable in conjunction with seamless cold drawn precision steel tubes according to EN 10305-1 (materials E235, E355) and stainless steel tubes (material 1.4571 / AISI 316 Ti).

Please consult STAUFF for information regarding the processing of tubes made from stainless steel and other materials.



## STAUFF Form EVO Clamping Jaws ▪ Type FI-FB



Tube OD (mm/in)	Series	Weight per piece (kg/lbs) Ca.	Ordering Codes
6	L / S	2,37	FI-FB-06L/S-F2-S-A
.24		5,21	
8	L / S	2,36	FI-FB-08L/S-F2-S-A
.31		5,19	
10	L / S	2,32	FI-FB-10L/S-F2-S-A
.39		5,10	
12	L / S	2,30	FI-FB-12L/S-F2-S-A
.47		5,06	
15	L	2,37	FI-FB-15L-F2-S-A
.59	L	5,21	
16	S	2,31	FI-FB-16S-F2-S-A
.63		5,08	
18	L	2,28	FI-FB-18L-F2-S-A
.71	L	5,02	
20	S	2,24	FI-FB-20S-F2-S-A
.79		4,93	
22	L	2,32	FI-FB-22L-F2-S-A
.87		5,10	
25	S	2,17	FI-FB-25S-F2-S-A
.98		4,77	
28	L	2,32	FI-FB-28L-F2-S-A
1.10		5,10	
30	S	2,05	FI-FB-30S-F2-S-A
1.18		4,51	
35	L	1,92	FI-FB-35L-F2-S-A
1.38		4,22	
38	S	1,92	FI-FB-38S-F2-S-A
1.50		4,22	
42	L	1,77	FI-FB-42L-F2-S-A
1.65		3,89	

 Overview tube dimensions  
Parameter and Tools STAUFF Form EVO

P

## Carbon Steel

Size	Wallthickness								
	1	1,5	2	2,5	3	3,5	4	5	6
	E235/ E355	E235/ E355	E235/ E355	E235/ E355	E235/ E355	E235/ E355	E235/ E355	E235/ E355	E235/ E355
6	-		-	-	-	-	-	-	-
8	-				-	-	-	-	-
10	-					-	-	-	-
12	-	▪				-	-	-	-
15	-	▪	▪	▪	-	-	-	-	-
16	-	-	▪	▪		-		-	-
18	-	▪	▪	▪		-		-	-
20	-	-	▪	▪				-	-
22	-	-	▪	▪				-	-
25	-	-	▪	▪					-
28	-	-	-	▪	▪				-
30	-	-	-	▪	▪	-			
35	-	-	-	▪	▪	-			
38	-	-	-	-	▪	-	▪		
42	-	-	-	-	▪	▪	▪	-	

Parameter set and tools available. To use without tube supports.

## Stainless Steel

Wallthickness	1 1,5 2 2,5 3 3,5 4 5 6								
	316ti	316ti	316ti	316ti	316ti	316ti	316ti	316ti	316ti
-				-	-	-	-	-	-
-				-	-	-	-	-	-
-				-	-	-	-	-	-
-	▪	▪	-	-	-	-	-	-	-
-	-	▪	▪	-	-	-	-	-	-
-	-	-	▪	▪	-	-	-	-	-
-	-	-	▪	▪	-	-	-	-	-
-	-	-	▪	▪	-	-	-	-	-
-	-	-	-	▪	▪	-	-	-	-
-	-	-	-	▪	▪	-	-	-	-
-	-	-	-	-	▪	▪	-	-	-
-	-	-	-	-	▪	▪	-	-	-
-	-	-	-	-	-	▪	▪	-	-
-	-	-	-	-	-	-	▪	▪	-
-	-	-	-	-	-	-	-	▪	▪

Parameter set and tools available. To use with internal tube supports.



**External Foot Control Switch**  
**Type SFO/PRC-POC-FS**



- Enables the operator to trigger assembly processes from a larger distance to the machine (cable length: 7 m / 22.97 ft)

**STAUFF Form EVO Oil**  
**Type Oil-Staff-Form-1L**



- Enables faultless, mechanical tube forming with STAUFF Form EVO machines when using stainless steel tubes

**STAUFF Oil with brush**  
**Type SPR-PRC-H-M-OS**



- Enables faultless, mechanical tube forming with STAUFF Form EVO machines when using stainless steel tubes





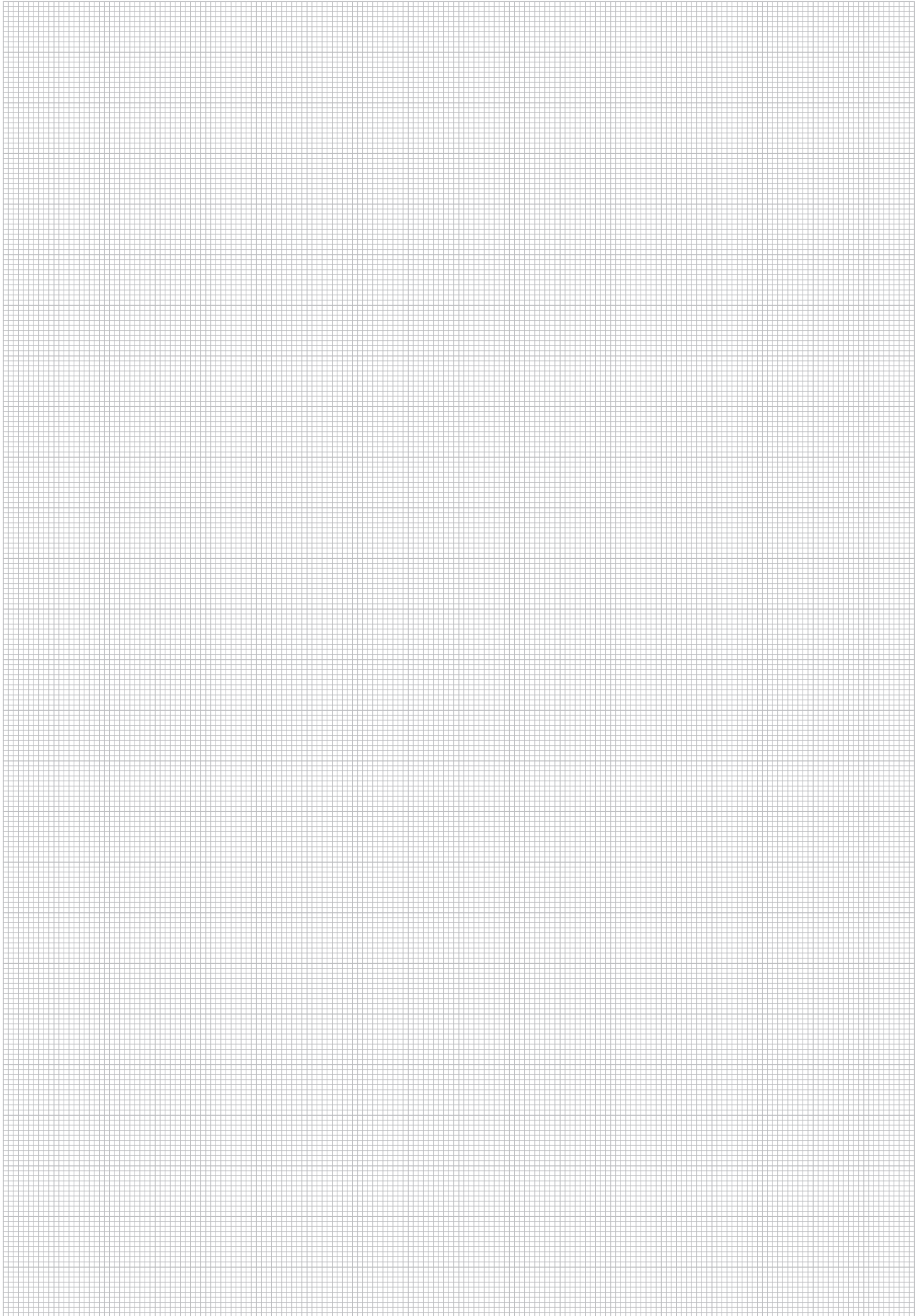

P







**Thread Identification Board**

FI-TIB

276



**Cone Gauges**

FI-KOL

277



## Thread Identification Board Type FI-TIB

### Product Description

The STAUFF Thread Identification Board is intended to be used as a universal tool for workshops, warehouses or sales counters allowing quick and easy determination of common thread types and sizes, e.g. for male stud tube connectors and test couplings.

The board is available in two different versions:

#### FI-TIB-M/G

##### 13 Metric Parallel Threaded Ports

M8 x 1 / M10 x 1 / M12 x 1,5 / M14 x 1,5 /  
M16 x 1,5 / M18 x 1,5 / M20 x 1,5 / M22 x 1,5 /  
M26 x 1,5 / M27 x 2 / M33 x 2 / M42 x 2 / M48 x 2

##### 8 Whitworth Parallel Pipe Threaded Ports

G1/8 / G1/4 / G3/8 / G1/2 / G3/4 / G1 / G1 1/4 / G1 1/2

#### FI-TIB-N/U

##### 8 National Pipe Threaded Ports

1/8–27 NPT / 1/4–18 NPT / 3/8–18 NPT /  
1/2–14 NPT / 3/4–14 NPT / 1–11.5 NPT /  
1 1/4–11.5 NPT / 1 1/2–11.5 NPT

##### 9 UNF/UN Threaded Ports

7/16–20 UNF / 1/2–20 UNF / 9/16–18 UNF /  
3/4–16 UNF / 7/8–14 UNF / 1 1/16–12 UN /  
1 5/16–12 UN / 1 5/8–12 UN / 1 7/8–12 UN



### Product Features

- Covering all relevant thread type and sizes of male stud tube connectors and test couplings
- Boards made of hardened quality steel
- Finished with an extremely resistant cathodic electrodeposition coating
- Laser markings indicating the thread types and sizes next to the threaded ports
- Non-slip rubber feet providing good stability

### Technical Data

- Dimensions (W x D x H): 275 mm x 190 mm x 31 mm  
10.82 in x 7.48 in x 1.22 in
- Clearance height: 13 mm / .51 in  
(height of the rubber feet)
- Weight: 6,0 kg / 13.2 lbs

### Note

Thread identification boards are intended to be tools for the basic determination of thread types and sizes. They do not replace high-precision thread gauges and measurement devices (should these become necessary at any point).

Q



## Cone Gauges Type FI-KOL

### Product Description

These cone gauges are designed for wear checks on the 24° cone for all STAUFF final assembly studs 6 - 42 mm. To ensure accuracy during cutting ring assembly, the assembly stud has to be checked for wear and damage after max. 50 assembly processes (DIN 3859-2).

This set is suitable for all final assembly studs of type FI-MFK as well as for manual assembly cones of type FI-FK.

The cone gauges are available individually or as a complete set for all sizes in a convenient case.

### Product Features

- Ensure accurate cutting ring assembly because the target cone in the stud can be verified with precision
- Prevents premature replacement of the studs
- Easy handling

### Technical Data

- Dimensions Case (W x D x H):  
357 mm x 305 mm x 80 mm  
14.06 in x 12.01 in x 3.15 in
- Dimensions Cone Gauges (H)  
95 mm / 3.74 in



### Ordering Code

- Cone Gauge Kit in Box (Size 6 to 42)

**FI-Box-Cone-Gauge-Kit-6-42**

### Single Cone Gauges

Size	Ordering Codes
06L/S	FI-KOL-06L/S-W1
08L/S	FI-KOL-08L/S-W1
10L/S	FI-KOL-10L/S-W1
12L/S	FI-KOL-12L/S-W1
14S	FI-KOL-14S-W1
15L	FI-KOL-15L-W1
16S	FI-KOL-16S-W1
18L	FI-KOL-18L-W1
20S	FI-KOL-20S-W1
22L	FI-KOL-22L-W1
25S	FI-KOL-25S-W1
28L	FI-KOL-28L-W1
30S	FI-KOL-30S-W1
35L	FI-KOL-35L-W1
38S	FI-KOL-38S-W1
42L	FI-KOL-42L-W1







**STAUFF Clean**  
Pipe, Tube and Hose Cleaning System  
SC

280



**Manual Tube Bender**  
TUB-MA

282



**Tube Bending and Saw Device**  
TUBSD-MA

283



**Tube Saw Device**  
TUSD-MA

284



**Tube Reamer**  
TUD-MA

285



## STAUFF Clean Pipe, Tube and Hose Cleaning System

### Product Description

The STAUFF Clean System comprises of a pneumatic launcher and a range of specially designed nozzles and projectiles.

The launcher uses standard industrial compressed air pressure between 6 and 8 bar / 87 and 116 PSI to propel a foam projectile through the nozzle and into the pipe, tube or hose bore to have their inside surface cleaned from any unwanted contamination.

This provides a safe and environmentally friendly tool that requires little formal expertise to operate and apply.

The **launcher** is the part of the system that controls the air supply to propel the projectile from start to finish of the cleaning job.

The **nozzles** are specially designed to affect an airtight seal on any pipe, tube or hose with or without end fittings. Its main purpose is to compress the foam projectile allowing it to enter the internal diameter of the pipe, tube or hose to be cleaned.

The **projectile** is the part of the system that does the cleaning: The foam projectile is sized to be approximately 15% larger than the internal diameter of the pipe, tube or hose to be cleaned. The compression of the projectile against the internal wall cleans the internal surface and expels any loose contaminants from the end of the pipe, tube or hose.

The STAUFF Clean System is available as separate components or in a variety of kit forms comprising various nozzle types, adaptor and launcher, all contained in a heavy duty carrying case.



R

## STAUFF Clean Launchers / Launcher Kits



### Characteristics

- Pneumatic pistol-grip launcher
- Light-weight and ergonomic design
- Easy to operate and apply
- Connection to air supply with quick release coupling
- Suitable for any type of nozzle
- Delivered separately or in a variety of kit forms including carrying case, adaptor ring and nozzles (if required)

### Technical Data

- Air compressor requirement:  
6 ... 8 bar / 87 ... 116 PSI
- Effective air volume:  
250 ... 400 l/min / 66 ... 106 US GPM

### Ordering Codes

- Launcher only **SC-LG**
- Launcher kit (launcher, kit and adaptor) **SC-LK**
- Kit (as above) with set of 10 Universal nozzles **SC-10UV-K**
- Kit (as above) with set of 18 Metric Tube nozzles **SC-18MT-K**
- Kit (as above) with set of 10 JIC nozzles **SC-10J-K**
- Kit (as above) with set of 7 BSP nozzles **SC-7B-K**
- Kit (as above) with set of 7 NPT nozzles **SC-7N-K**

Contact STAUFF for alternative connection adaptors and couplings.





## STAUFF Clean Nozzles / Nozzle Sets

### Universal Nozzle Set (SC-U-SET)

The Universal Nozzle is designed with a tapered seat that will allow it to suit for 90% of applications, including Hose, Tube and Pipe, with or without fittings, in hydraulic and pneumatic pipe systems, condenser tubes, boiler tubes and food lines.

The Universal Nozzle kit fits all and will accommodate applications with JIC, SAE and BSP end fittings.

The set of 10 nozzles consists of the following sizes: 6 mm, 8 mm, 10 mm, 13 mm, 16 mm, 19 mm, 25 mm and 32 mm.

### JIC Nozzle Set (SC-J-SET)

The JIC Nozzle is designed specifically for use with JIC and SAE type fittings. The nozzles are machined to accommodate both male and female configuration, ensuring a perfect airtight seal every time.

The set of 10 nozzles consist of the following sizes: 6 mm, 8 mm, 10 mm, 13 mm, 16 mm, 19 mm, 25 mm, 32 mm, 38 mm and 50 mm.

### Metric Tube Nozzle Set (SC-M-SET)

The Metric Tube Nozzle is intended for use specifically with Metric sized tube and is designed to fit over the outside of the tube or pipe being cleaned.

The inside diameter of the nozzle is reduced to match the inside diameter of the tube. The nozzles are machined from solid bar stock and designed for superior strength.

The set of 18 nozzles consist of the following sizes: 6 mm, 8 mm, 10 mm, 12 mm, 14 mm, 15 mm, 16 mm, 18 mm, 20 mm, 22 mm, 25 mm, 28 mm, 30 mm, 35 mm, 38 mm, 42 mm, 50 mm and 60 mm.

### BSP Nozzle Set (SC-B-SET)

The BSP Nozzle is designed specifically for BSP configuration fittings. The nozzles are machined to accommodate both male and female configurations, ensuring a perfect airtight seal every time.

The set of 7 nozzles consist of the following sizes: 6 mm, 10 mm, 13 mm, 16 mm, 19 mm, 25 mm and 32 mm.



**Adaptor Ring for Nozzels (SCN-AR)**  
Required for sizes 6-32 mm / 1/4-1 1/4 in



If required, nozzles can be supplied separately. Contact STAUFF for details.

### NPT Nozzle Set (SC-N-SET)

The NPT Nozzle is designed specifically for NPT configuration fittings. The nozzles are machined to accommodate both male and female configurations, ensuring a perfect airtight seal every time.

The set of 7 nozzles consist of the following sizes: 1/4 in, 3/8 in, 1/2 in, 5/8 in, 3/4 in, 1 in and 1 1/4 in.

## STAUFF Clean Projectiles

### Coupling Series (SCP-C)

Intended for the cleaning of hose assemblies (hose with end fittings, adjustments, etc.) or the removal of loose contamination from pipe, tube or hose.



### Abrasive Series (SCP-A)

Intended for the internal cleaning of metal pipe and tube to remove light contaminants (rust and scale). They are recognised by the shorter abrasive pad fixed to one end of the projectile.



### Grinding Series (SCP-G)

Intended for the internal cleaning of metal pipe and tube to remove medium and heavy contamination (rust and scale) from the internal surface. They are recognised by the longer abrasive pad fixed to one end of the projectile that is coated in Silicon Carbide.



Size	Pipe / Tube / Hose ID		Ordering Codes		
	(mm)	(in)	Coupling Series (SCP-C)	Abrasive Series (SCP-A)	Grinding Series (SCP-G)
07	4,8	3/16	SCP-C-07	SCP-A-07	SCP-G-07
09	6,4	1/4	SCP-C-09	SCP-A-09	SCP-G-09
10	6,4	1/4	SCP-C-10	SCP-A-10	SCP-G-10
12	7,9	5/16	SCP-C-12	SCP-A-12	SCP-G-12
14	9,5	3/8	SCP-C-14	SCP-A-14	SCP-G-14
16	11,1	7/16	SCP-C-16	SCP-A-16	SCP-G-16
18	12,7	1/2	SCP-C-18	SCP-A-18	SCP-G-18
20	14,3	9/16	SCP-C-20	SCP-A-20	SCP-G-20
22	15,9	5/8	SCP-C-22	SCP-A-22	SCP-G-22
26	19,1	3/4	SCP-C-26	SCP-A-26	SCP-G-26
28	20,6	13/16	SCP-C-28	SCP-A-28	SCP-G-28
30	22,2	7/8	SCP-C-30	SCP-A-30	SCP-G-30
33	25,4	1	SCP-C-33	SCP-A-33	SCP-G-33
36	26 / 27	1 1/16	SCP-C-36	SCP-A-36	SCP-G-36
38	28,6	1 1/8	-	SCP-A-38	SCP-G-38
40	31,8	1 1/4	SCP-C-40	SCP-A-40	SCP-G-40
45	34,9	1 3/8	SCP-C-45	SCP-A-45	SCP-G-45
50	38,1	1 1/2	SCP-C-50	SCP-A-50	SCP-G-50
55	44,5	1 3/4	SCP-C-55	SCP-A-55	SCP-G-55
60	50,8	2	SCP-C-60	SCP-A-60	SCP-G-60

Please note: For optimum cleaning, it is recommended that projectiles are used once and then discarded and disposed of in an appropriate way.

Safety note: A mesh collection bag should be secured to the pipe, tube or hose exit to avoid possible injury to personnel by the projectile exiting at high velocity.

Always wear protective safety glasses, ear protection and a dust mask when operating this system.



## Manual Tube Bender Typ TUB-MA

### Product Description

When used with a commercially available vice, STAUFF manual tube benders, type TUB-MA, enable common hydraulic tubes to be bent manually.

They are suitable for steel and stainless steel tubes with diameters of 6, 8, 10, 12, 14, 15, 16, 18 and 22 mm with a defined minimum wall thickness.

In addition to the metric version, a model for handling inch-gauge tubes with diameters of between 1/4 and 7/8 inches is also available.

The eight bending rollers – six in the imperial version – ensure maximum wear.

A scale lasered onto the bending rollers enhances the accuracy of the required bending angle with superior precision.

The manual tube bender is supplied with all the necessary components and multilingual instructions for use as a complete kit in a high-quality steel case.

### Product Features

- Small bending radii allow for compact assemblies
- Optimised bending contour, which enables tube bends free of flattening and constriction
- hard wearing steel bending rolls
- ideal for versatile site use, possibly for installation work on site

### Technical Data

- Dimensions (W x D x H):  
640 mm x 165 mm x 70 mm  
25.20 in x 6.50 in x 2.76 in
- Weight (incl. Case):  
Metric Version 13,8 kg / 30.4 lbs  
Imperial Version 12,1 kg / 26.7 lbs



### Ordering Codes

- Manual Tube Bender Set in Steelcase (metric Version) **TUB-MA-M622-LV-KIT**
- Manual Tube Bender Set in Steelcase (imperial Version) **TUB-MA-I4140D-LV-KIT**

### Spare Parts / Accessories

Description	Ordering Codes
Bending Lever	TUB-MA-S-Bending-Lever
Baseplate	TUB-MA-S-Baseplate
Guide Roller	TUB-MA-S-Guide-Roller-W32
Hold Roll	TUB-MA-S-Hold-Roll-W101
Guide Roller Mount	TUB-MA-S-Guide-Roller-Mount
Bolt	TUB-MA-S-Bolt-M12x32
Pivot Pin	TUB-MA-S-Pivot-Pin
Bending Lever Support	TUB-MA-S-Bending-Lever-Support-W32
Bending Roller 6/8 mm	TUB-T-BE-M6/8-MIOD-W32
Bending Roller 10 mm	TUB-T-BE-M10-MIOD-W32
Bending Roller 12 mm	TUB-T-BE-M12-M622-W32
Bending Roller 14/15 mm	TUB-T-BE-M14/15-M622-W32
Bending Roller 16 mm	TUB-T-BE-M16-MIOD-W32
Bending Roller 18 mm	TUB-T-BE-M18-M622-W101
Bending Roller 20 mm	TUB-T-BE-M20-M622-W101
Bending Roller 22 mm	TUB-T-BE-M22-MIOD-W101
Bending Roller 1/2"	TUB-T-BE-080D-I4140D-W32
Bending Roller 3/4"	TUB-T-BE-120D-I4140D-W101

Parts assignment: [www.stauff.com/en/category/025000/025025/025021B](http://www.stauff.com/en/category/025000/025025/025021B)



Outer Diameter	Metric	Inch	Radius	Minimum Wall Thickness
6/8 mm (1/4"/ 5/16")	•	•	33 mm / 1.30 in	1,5 mm / .06 in
10 mm (3/8")	•	•		1,5 mm / .06 in
12 mm	•		40 mm / 1.57 in	2,0 mm / .08 in
1/2"		•		1,5 mm / .06 in
14 mm	•		48 mm / 1.89 in	2,0 mm / .08 in
15 mm	•			1,5 mm / .06 in
16 mm (5/8")	•	•	48 mm / 1.89 in	1,5 mm / .06 in
18 mm	•			2,0 mm / .08 in
3/4"		•	48 mm / 1.89 in	2,0 mm / .08 in
20 mm	•			2,0 mm / .08 in
22 mm (7/8")	•	•		

R



## Tube Bending and Saw Device Type TUBSD-MA

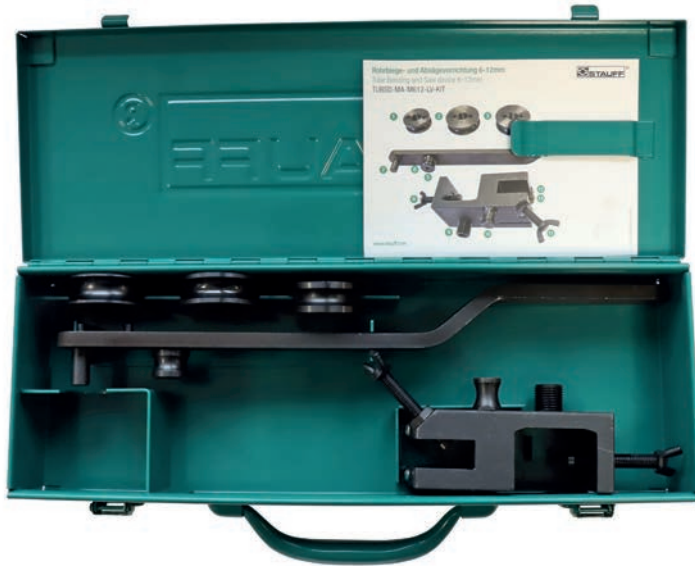

### Product Description

This sturdy steel case is designed for short-term use on the go, providing all components required for bending and sawing off hydraulic tubes made of steel or stainless steel. The case contains a combined manual tube bending and sawing device which can be attached with a standard vice or directly to a work-bench top with a thickness of up to 35 mm. The contour of the holding fixture ensures that cuts are made at a 90° angle.

Three low-wear bending rollers made of steel allow processing of steel or stainless steel tubes with an outer diameter of 6, 8, 10 or 12 mm. The optimised bending contour of the rollers prevents deformation of the tube even for smaller bending radii. A bending lever is also included in the set.

A standard hacksaw is used for sawing off the tube.

The case also has space for the STAUFF universal internal and external tube reamer for tube diameters from 6 to 35 mm. The reamer is not included in the set, but can be purchased separately, as can all components of this convenient repair set in a robust steel case.

### Ordering Code

▪ Tube Bending and Saw Device in Steelcase

**TUBSD-MA-M612-LV-KIT**

### Spare Parts / Accessories

Description	Ordering Codes
Bending roll 6/8mm (Radius 19/20mm)	TUBSD-T-BE-M6/8-W101
Bending roll 10mm (Radius 25mm)	TUBSD-T-BE-M10-W101
Bending roll 12mm (Radius 26mm)	TUBSD-T-BE-M12-W101
Bending-Lever-compl	TUBSD-S-Bending-Lever-compl-W101
Baseplate-compl	TUBSD-S-Baseplate-compl-W101
Hold-Roll	TUBSD-S-Hold-Roll-W101
Bending-Roll-Mount	TUBSD-S-Bending-Roll-Mount-W101
Round-Head-Rivet Kit 4 pcs.	Kit-TUBSD-S-Round-Head-Rivet-W5
SAW-Guide Kit 2 pcs.	Kit-TUBSD-S-SAW-Guide-W101
Pivot-Pin	TUBSD-S-Pivot-Pin-W101
Guide-Roller-Mount	TUBSD-S-Guide-Roller-Mount-W101
Guide-Roller	TUBSD-S-Guide-Roller-W101
Butterfly lock bolt	TUBSD-S-Butterfly lock bolt W101

Parts assignment: [www.stauff.com/en/category/025000/025026/025022D](http://www.stauff.com/en/category/025000/025026/025022D)

### Product Features

- Bending and sawing with one device
- Wear-resistant steel bending rollers
- Small bending radii for compact installations
- Optimised bending contour: The tube diameter is not deformed during the bending process
- Saw blade guiding ensures 90° cuts
- Can be used with or without a vice
- Ideal for flexible mobile use, e.g. for installation work at a construction site

### Technical Data

- Dimensions (W x D x H):  
355 mm x 125 mm x 56 mm  
13.98 in x 4.92 in x 2.20 in
- Weight (incl. Case): 3,4kg / 7.50 lbs



## Tube Saw Devise Type TUSD-MA

### Product Description

This device can be used to cut steel and stainless steel tubes with an outer diameter between 6 and 42 mm at a precise 90° angle. It can either be used with a vice or simply clamped onto the tube for cutting.

A standard hacksaw is used for sawing off the tube.

### Product Features

- 90° cut on tubes up to 42 mm
- Tube diameter is not deformed during the clamping process
- Robust, durable design
- No vice required, device can also simply be clamped onto the tube
- The saw blade guide can easily be replaced separately when it is worn
- Ideal for flexible mobile use, e.g. for installation work at a construction site

### Technical Data

- Dimensions (W x D x H):  
80 mm x 70 mm x 140 mm  
3.15 in x 2.76 in x 5.51 in
- Weight: 1,6 kg / 3.5 lbs

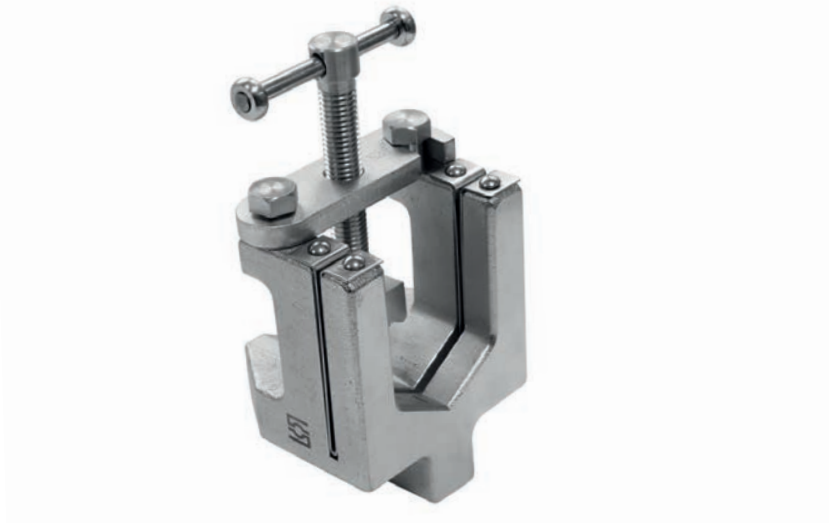

### Ordering Code

- Tube Saw Devise

**TUSD-MA-M642**

### Spare Parts / Accessories

Description	Ordering Codes
Round-Head-Rivet Kit 4 pcs.	Kit-SD-MA-S-Round-Head-Rivet-W5
SAW-Guide Kit 2 pcs.	Kit-SD-MA-S-Saw-Guide-W101
Barcked Bolt Kit 2 pcs.	Kit-SD-MA-S-Bolt-W32
Bracked-compl.	SD-MA-S-Bracked-compl.-W32

Parts assignment: [www.stauff.com/en/category/025000/025027/025022E](http://www.stauff.com/en/category/025000/025027/025022E)

R

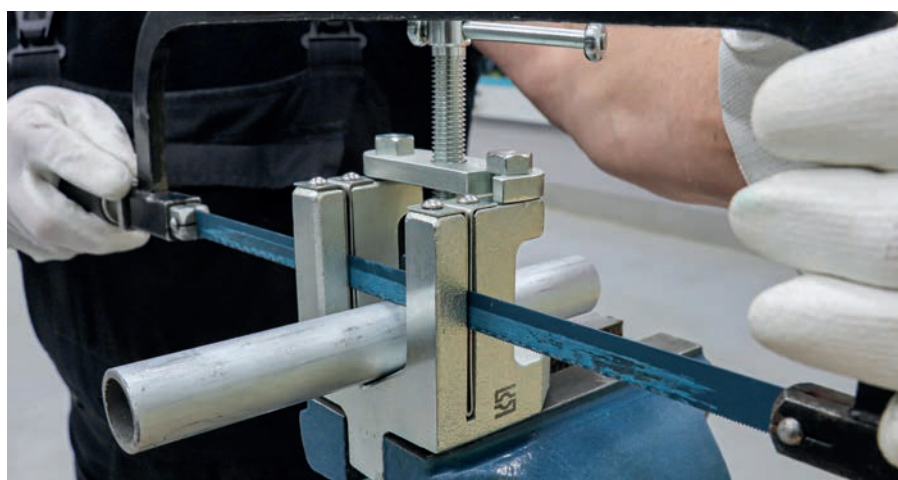

## Tube Reamer Type TUD-MA



### Product Description

The STAUFF universal internal and external tube reamer for tube diameters from 6 to 35 mm features high-quality sharpened cutting edges made of hardened special steel and ensures a flowing, "chatter-free" work process. Also available for tubes with an outer diameter from 10 to 54 mm.

Particularly convenient: An adapter for using the device with an electric drill at low speed is available for both sizes.

### Product Features

- Easy and quick burr removal on steel and stainless steel tubes
- High-quality sharpened cutting edges made of hardened special steel
- Chatter-free working

### Technical Data

- Dimensions TUD-MA-0635 (Ø x H):  
48 mm x 60 mm  
1.89 in x 2.36 in
- Weight: 0,2 kg / .44 lbs
- Dimensions TUD-MA-1054 (Ø x H):  
70 mm x 90 mm  
2.76 in x 3.54 in
- Weight: 0,6 kg / 1.32 lbs
- Dimensions TUD-ADA1-0635 (Ø x H):  
65 mm x 85 mm inkl. Welle  
2.55 in x 3.35 in
- Weight: 0,2 kg / .44 lbs
- Dimensions TUD-ADA2-1054 (Ø x H):  
91 mm x 92 mm inkl. Welle  
3.58 in x 3.62 in
- Weight: 0,4 kg / .88 lbs

### Ordering Codes

Description	Ordering Codes
Tube reamer 6-35mm	TUD-MA-0635
Adapter for Tube reamer 6-35mm	TUD-ADA1-0635
Tube reamer 10-54mm	TUD-MA-1054
Adapter for Tube reamer 10-54mm	TUD-ADA2-1054



R



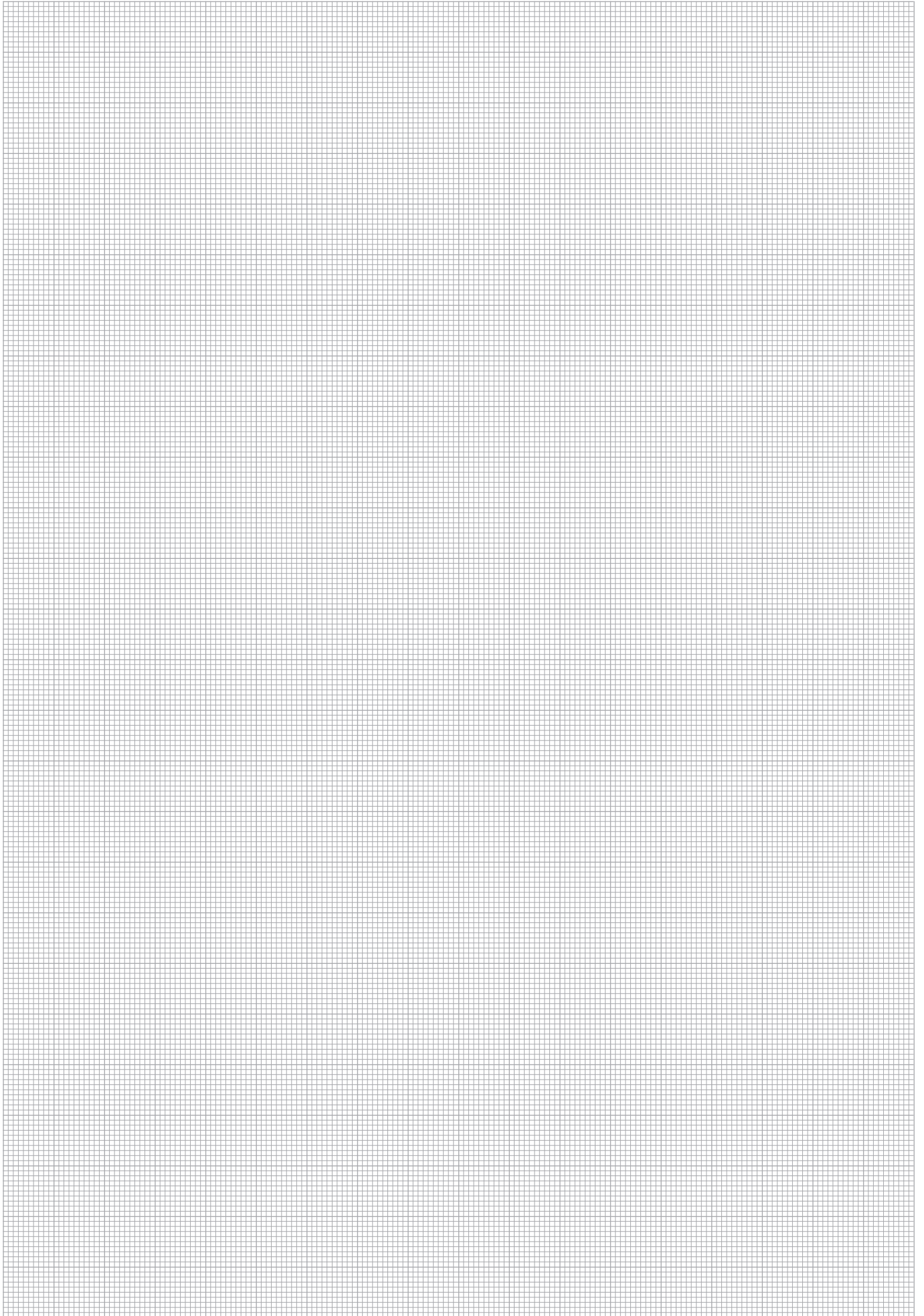

R



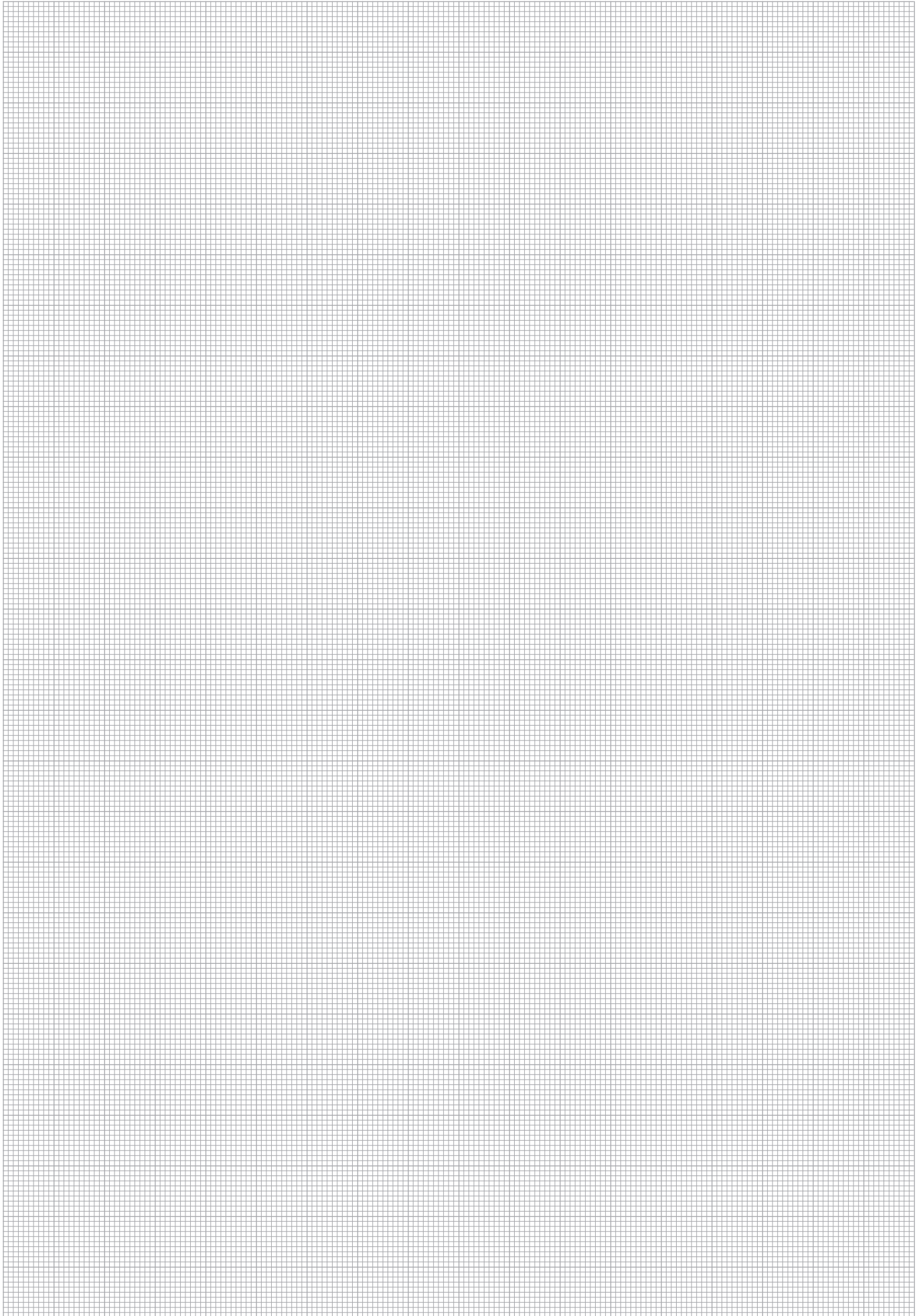

R







<b>Assembly Instructions for STAUFF Connect 24° Tube Fittings with Double Edge Cutting Ring (Type FI-DS)</b>	<b>290-297</b>
100% Assembly with the Manual Final Assembly Stud (Type FI-FK) and Assembly with the Fitting Body	290
50% Assembly with the Manual Pre-Assembly Stud (Type FI-VK) and Assembly with the Fitting Body	292
Direct Assembly with the Fitting Body	294
Machine-Assisted 100% Assembly with a STAUFF Press Assembly Machine and Assembly with the Fitting Body	296
Machine-Assisted 50% Assembly with a STAUFF Press Assembly Machine and Assembly with the Fitting Body	297
<b>Assembly Instructions for STAUFF Connect 24° Tube Fittings with Soft-Sealing Cutting Ring (Type FI-WDDS)</b>	<b>298-303</b>
100% Assembly with the Manual Final Assembly Stud (Type FI-FK) and Assembly with the Fitting Body	298
Direct Assembly with the Fitting Body	300
Machine-Assisted 100% Assembly with a STAUFF Press Assembly Machine and Assembly with the Fitting Body	302
<b>Assembly Instructions for Support Sleeves</b>	<b>304</b>
<b>Assembly Instructions for STAUFF Form EVO Tube Fittings</b>	<b>306</b>
<b>Assembly Instructions for STAUFF Connect 37° Flared Tube Fittings</b>	<b>310</b>
<b>Assembly Instructions for 24° Weld Cones with O-Ring</b>	<b>314</b>
<b>Assembly Instructions for Tube Fittings with 24° Taper and O-Ring</b>	<b>316</b>
<b>Assembly Instructions for Tube Fittings with Standpipe</b>	<b>316</b>
<b>Assembly Instructions for Tube Fittings with Male Threaded Stud</b>	<b>317</b>
<b>Assembly Instructions for Banjo Fittings</b>	<b>320</b>
<b>Assembly Instructions for Adjustable Fitting with Locknut (WEE, VEE, TEE, LEE)</b>	<b>321</b>



## Assembly Instructions for STAUFF Connect 24° Tube Fittings with Double Edge Cutting Ring (Type FI-DS)

100% Assembly with the Manual Final Assembly Stud (Type FI-FK) and Assembly with the Fitting Body

### 1. Tube Preparation

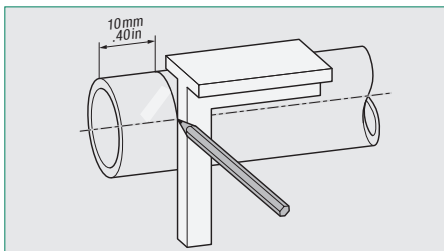

Saw off tube in right angle and at least 10 mm / .40 in from the cut made by the tube manufacturer / supplier in order to avoid failures caused during shipment.

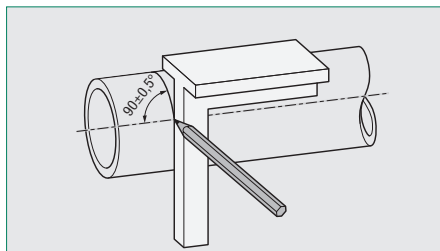

A maximum angular deviation / tolerance of  $\pm 0,5^\circ$  relative to the tube axis is permissible.

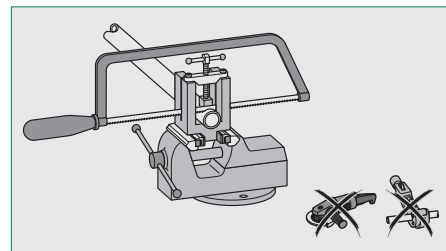

Only use proper tube sawing machinery or equipment. Do not use tube cutters or grinders as this may result in unwanted angled cuts and cause severe burring.

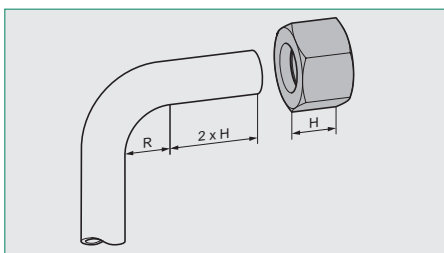

For tube bends, the length of the straight section of the tube end to the start of the bending radius has to be twice the height of the union nut.

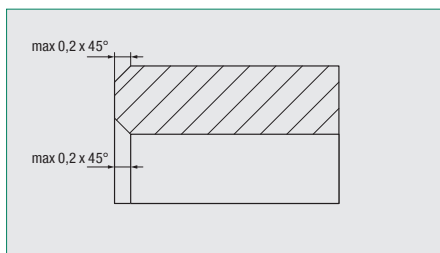

Slightly deburr inside and outside of the tube end (max 0,2 x 45°). The assembly area of the tube has to be free of contamination, chips and paint.



Please note: Improperly prepared and contaminated tubes will affect the service life of the connection and may result in leakage.

### 2. Assembly Preparation

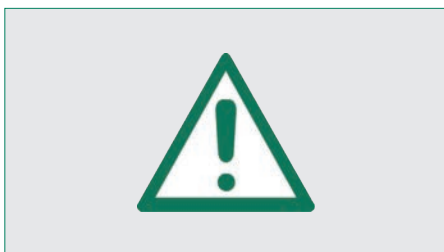

Please note: Hardened final assembly studs are wear-resistant, thus allowing for consistent assembly results with a maximum degree of accuracy, reliability and process stability.

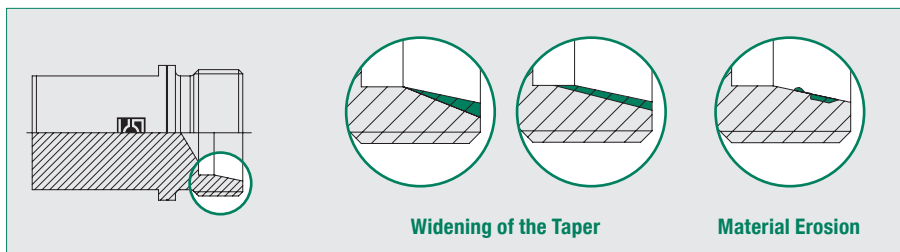

However, they have to be checked for dimensional accuracy regularly. Assembly studs that are damaged and/or dimensionally not accurate must be replaced under any circumstances!

Typical damages include widening of the 24° angle or the entire taper, as well as material erosion.

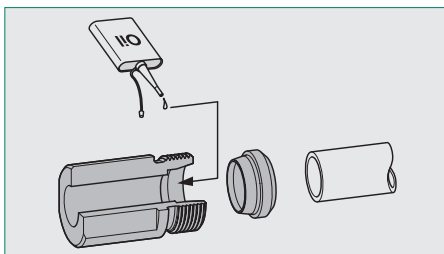

Lightly lubricate the 24° taper of the final assembly stud (e.g. using mineral-oil based hydraulic fluid HLP32). Do not use lubricating grease!

Immediately proceed with the assembly in order to avoid exposure to contamination.

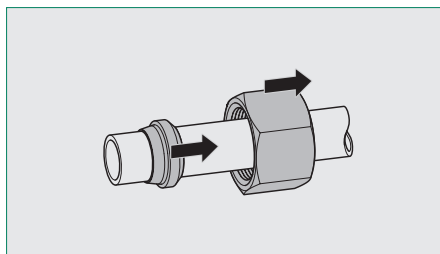

Consecutively put the union nut first and then the cutting ring onto the tube end.

Pay attention to the correct alignment of the cutting ring: The cutting edges have to face to the tube end.

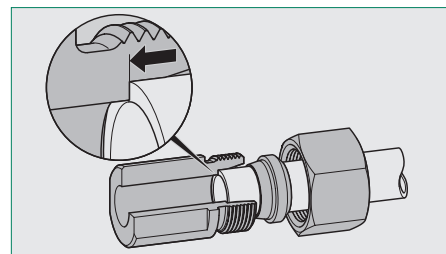

Carefully insert the tube end into the 24° taper of the final assembly stud and push it firmly against the inner stop.

The tube must be held in this position during the entire assembly process in order to avoid faulty assembly.

S



## Assembly Instructions for STAUFF Connect 24° Tube Fittings with Double Edge Cutting Ring (Type FI-DS)

100% Assembly with the Manual Final Assembly Stud (Type FI-FK) and Assembly with the Fitting Body

### 3. Assembly in the Assembly Stud

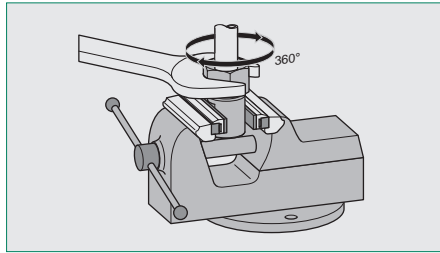
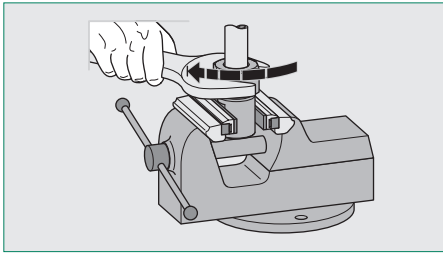

Tighten the union nut until the noticeable increase in force (pressure point). The cutting ring now grips the tube, which can no longer be rotated.

Use a suitable spanner to tighten the union nut another full turn (360°) beyond the pressure point. In doing so, the cutting ring will uniformly cut into the tube.

### 4. Inspection

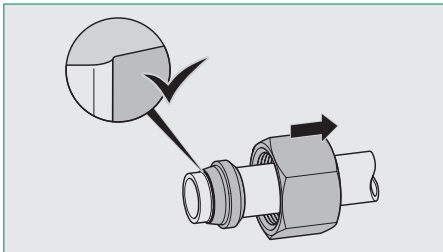

Fully untighten the union nut for a visual inspection after the assembly. A raise of tube material must be clearly visible in front of the cutting edge.

In this position, it is still permissible for the cutting ring to turn on the tube, but not to be displaced in axial direction of the tube.

Please note: If not enough tube material has been raised in front of the cutting edge or if the cutting ring is still capable of being displaced in axial direction, the assembly procedure must be repeated by using more force, and the result must be re-checked.

### 5. Assembly with the Fitting Body

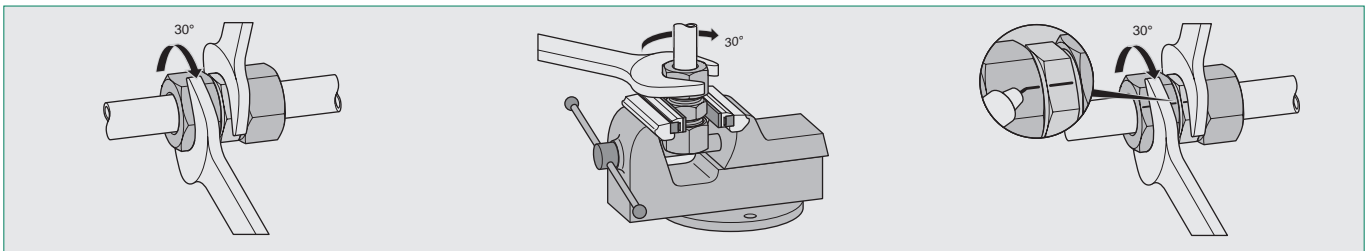

Carefully insert the assembled tube end into the 24° taper of the fitting body.

Use a suitable spanner to tighten the union nut until the noticeable increase in force, and then finish the assembly with another approximately 1/12 a turn (30°) beyond this point.

Always use a second spanner to hold the fitting body during the entire assembly procedure.

In case of unfavourable mounting conditions or larger tube dimensions, use a bench vice for the assembly.

A marking line applied on the union nut and the fitting body makes it easier to indicate the sufficient tightening angle.

### 6. Repeated Assembly

For repeated assemblies, please use a suitable spanner to tighten the union nut until the noticeable increase in force, and then finish the assembly with another approximately 1/12 a turn (30°) beyond this point.



## Assembly Instructions for STAUFF Connect 24° Tube Fittings with Double Edge Cutting Ring (Type FI-DS)

50% Assembly with the Manual Pre-Assembly Stud (Type FI-VK) and Assembly with the Fitting Body

### 1. Tube Preparation

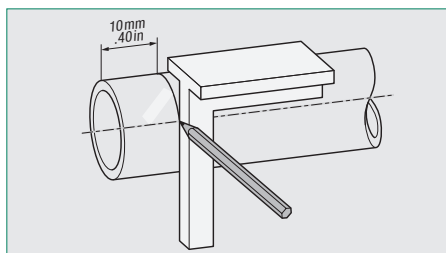

Saw off tube in right angle and at least 10 mm / .40 in from the cut made by the tube manufacturer / supplier in order to avoid failures caused during shipment.

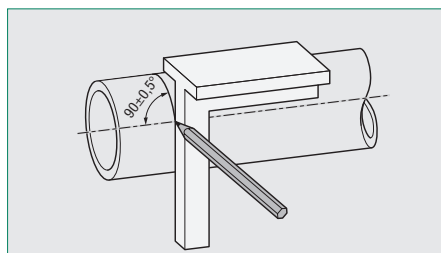

A maximum angular deviation / tolerance of  $\pm 0,5^\circ$  relative to the tube axis is permissible.

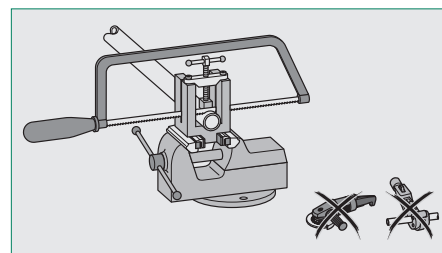

Only use proper tube sawing machinery or equipment. Do not use tube cutters or grinders as this may result in unwanted angled cuts and cause severe burring.

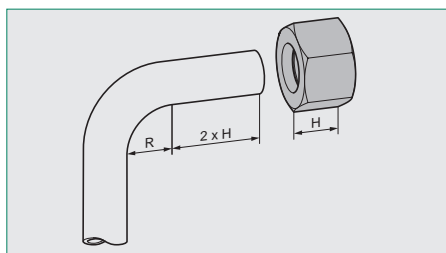

For tube bends, the length of the straight section of the tube end to the start of the bending radius has to be twice the height of the union nut.

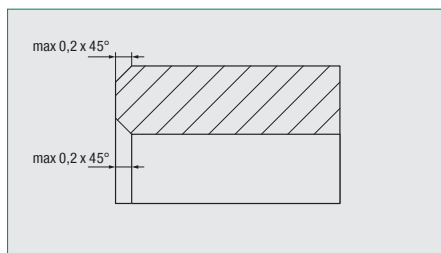

Slightly deburr inside and outside of the tube end (max 0,2 x 45°). The assembly area of the tube has to be free of contamination, chips and paint.



Please note: Improperly prepared and contaminated tubes will affect the service life of the connection and may result in leakage.

### 2. Assembly Preparation

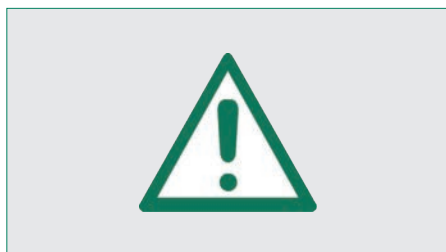

Please note: Hardened pre-assembly studs are wear-resistant, thus allowing for consistent assembly results with a maximum degree of accuracy, reliability and process stability.

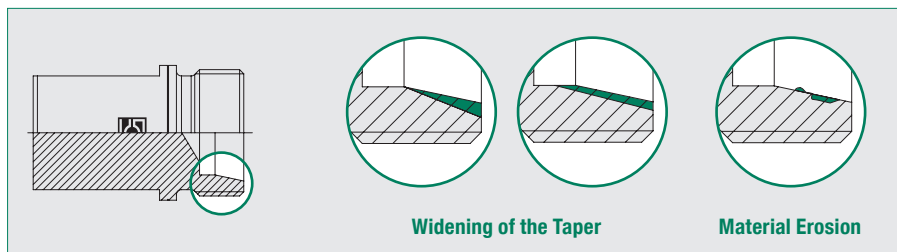

However, they have to be checked for dimensional accuracy regularly. Assembly studs that are damaged and/or dimensionally not accurate must be replaced under any circumstances!

Typical damages include widening of the 24° angle or the entire taper, as well as material erosion.

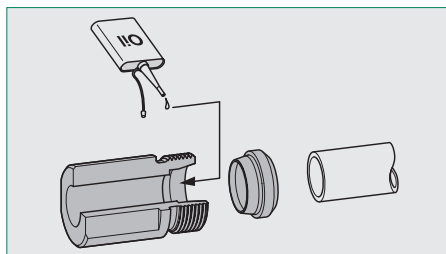

Lightly lubricate the 24° taper of the pre-assembly stud (e.g. using mineral-oil based hydraulic fluid HLP32). Do not use lubricating grease!

Immediately proceed with the assembly in order to avoid exposure to contamination.

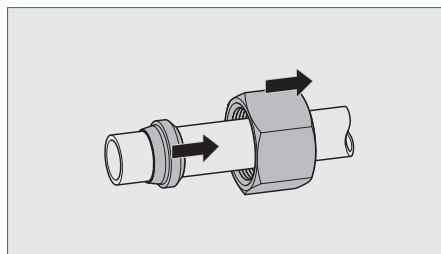

Consecutively put the union nut first and then the cutting ring onto the tube end.

Pay attention to the correct alignment of the cutting ring: The cutting edges have to face to the tube end.

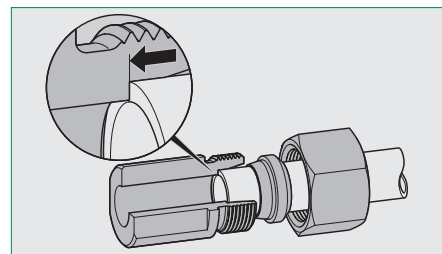

Carefully insert the tube end into the 24° taper of the pre-assembly stud and push it firmly against the inner stop.

The tube must be held in this position during the entire assembly process in order to avoid faulty assembly.

S



## Assembly Instructions for STAUFF Connect 24° Tube Fittings with Double Edge Cutting Ring (Type FI-DS)

50% Assembly with the Manual Pre-Assembly Stud (Type FI-VK) and Assembly with the Fitting Body

### 3. Assembly in the Assembly Stud

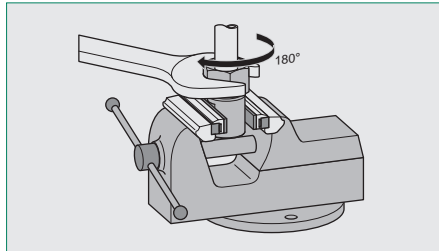
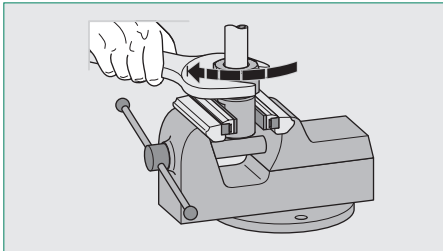

Tighten the union nut until the noticeable increase in force (pressure point). The cutting ring now grips the tube, which can no longer be rotated.

Use a suitable spanner to tighten the union nut another 1/2 a turn (180°) beyond the pressure point. In doing so, the cutting ring will uniformly cut into the tube.

### 4. Assembly with the Fitting Body

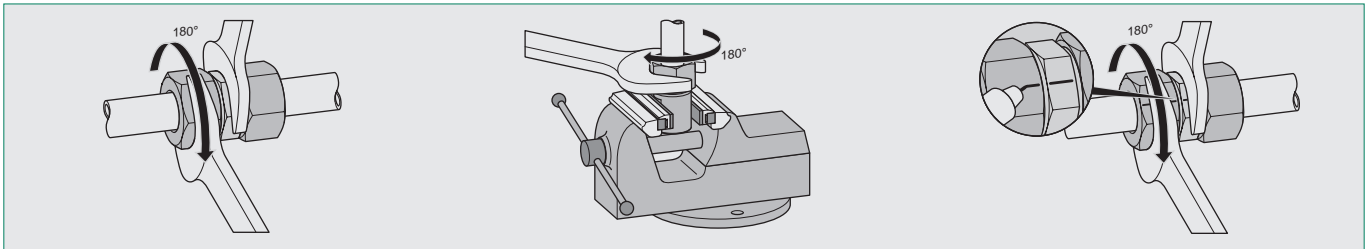

Carefully insert the assembled tube end into the 24° taper of the fitting body.

Use a suitable spanner to tighten the union nut until the noticeable increase in force, and then finish the assembly with another approximately 1/2 a turn (180°) beyond this point.

Always use a second spanner to hold the fitting body during the entire assembly procedure.

In case of unfavourable mounting conditions or larger tube dimensions, use a bench vice for the assembly.

A marking line applied on the union nut and the fitting body makes it easier to indicate the sufficient tightening angle.

### 5. Inspection

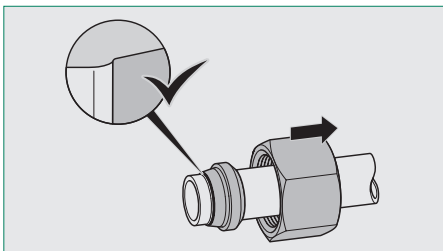

Fully untighten the union nut for a visual inspection after the assembly. A raise of tube material must be clearly visible in front of the cutting edge.

In this position, it is still permissible for the cutting ring to turn on the tube, but not to be displaced in axial direction of the tube.

Please note: If not enough tube material has been raised in front of the cutting edge or if the cutting ring is still capable of being displaced in axial direction, the assembly procedure must be repeated by using more force, and the result must be re-checked.

### 6. Repeated Assembly

For repeated assemblies, please use a suitable spanner to tighten the union nut until the noticeable increase in force, and then finish the assembly with another approximately 1/12 a turn (30°) beyond this point.



## Assembly Instructions for STAUFF Connect 24° Tube Fittings with Double Edge Cutting Ring (Type FI-DS) Direct Assembly with the Fitting Body

### 1. Tube Preparation

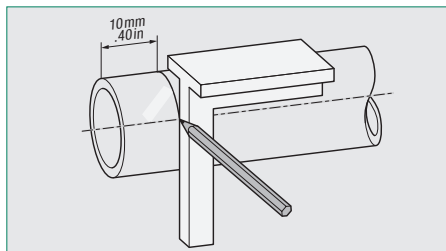

Saw off tube in right angle and at least 10 mm / .40 in from the cut made by the tube manufacturer / supplier in order to avoid failures caused during shipment.

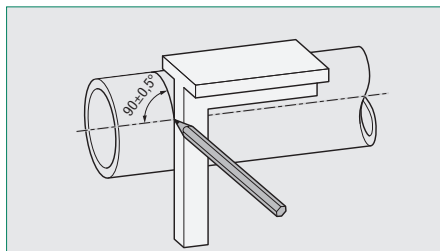

A maximum angular deviation / tolerance of  $\pm 0,5^\circ$  relative to the tube axis is permissible.

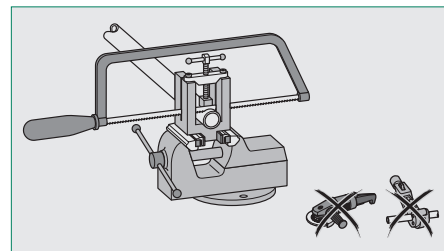

Only use proper tube sawing machinery or equipment. Do not use tube cutters or grinders as this may result in unwanted angled cuts and cause severe burring.

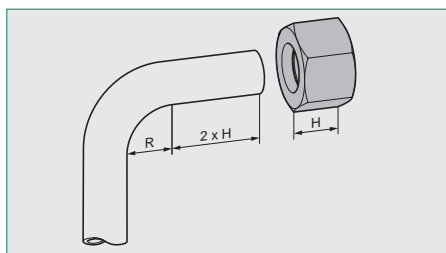

For tube bends, the length of the straight section of the tube end to the start of the bending radius has to be twice the height of the union nut.

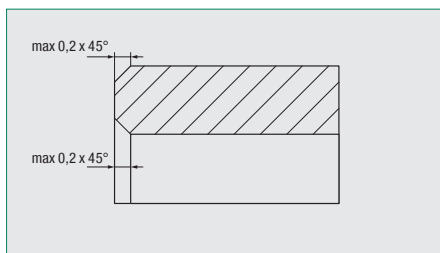

Slightly deburr inside and outside of the tube end (max 0,2 x 45°). The assembly area of the tube has to be free of contamination, chips and paint.



Please note: Improperly prepared and contaminated tubes will affect the service life of the connection and may result in leakage.

### 2. Assembly Preparation

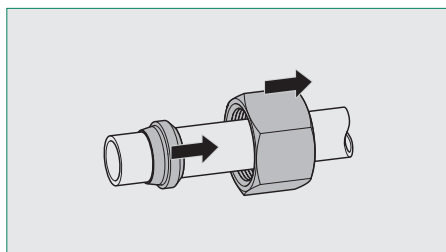

Consecutively put the union nut first and then the cutting ring onto the tube end.

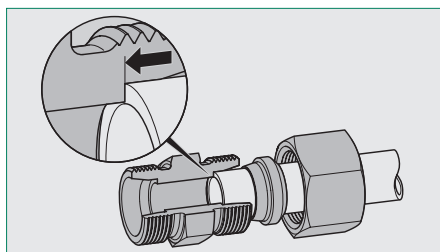

Carefully insert the tube end into the 24° taper of the fitting body and push it firmly against the inner stop.

Pay attention to the correct alignment of the cutting ring: The cutting edges have to face to the tube end.

The tube must be held in this position during the entire assembly process in order to avoid faulty assembly.

S



## Assembly Instructions for STAUFF Connect 24° Tube Fittings with Double Edge Cutting Ring (Type FI-DS)

### Direct Assembly with the Fitting Body

#### 3. Assembly in the Fitting Body

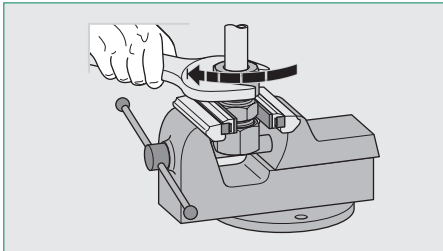

Tighten the union nut until the noticeable increase in force (pressure point). The cutting ring now grips the tube, which can no longer be rotated.

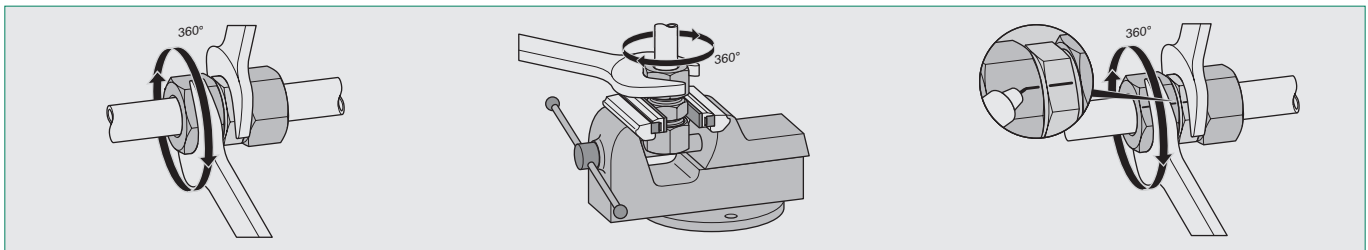

Use a suitable spanner to tighten the union nut another full turn (360°) beyond the pressure point. In doing so, the cutting ring will uniformly cut into the tube.

Always use a second spanner to hold the fitting body during the entire assembly procedure.

In case of unfavourable mounting conditions or larger tube dimensions, use a bench vice for the assembly.

A marking line applied on the union nut and the fitting body makes it easier to indicate the sufficient tightening angle.

#### 4. Inspection

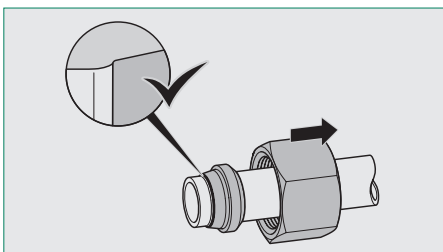

Fully untighten the union nut for a visual inspection after the assembly. A raise of tube material must be clearly visible in front of the cutting edge.

In this position, it is still permissible for the cutting ring to turn on the tube, but not to be displaced in axial direction of the tube.



Please note: If not enough tube material has been raised in front of the cutting edge or if the cutting ring is still capable of being displaced in axial direction, the assembly procedure must be repeated by using more force, and the result must be re-checked.

#### 5. Repeated Assembly

For repeated assemblies, please use a suitable spanner to tighten the union nut until the noticeable increase in force, and then finish the assembly with another approximately 1/12 a turn (30°) beyond this point.



## Assembly Instructions for STAUFF Connect 24° Tube Fittings with Double Edge Cutting Ring (Type FI-DS)

### Machine-Assisted 100% Assembly with a STAUFF Press Assembly Machine and Assembly with the Fitting Body

#### 1. Tube Preparation

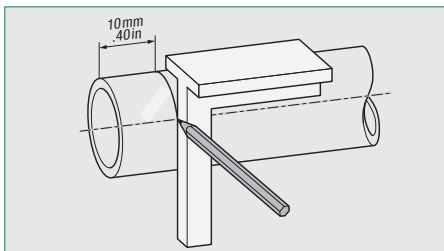

Saw off tube in right angle and at least 10 mm / .40 in from the cut made by the tube manufacturer / supplier in order to avoid failures caused during shipment.

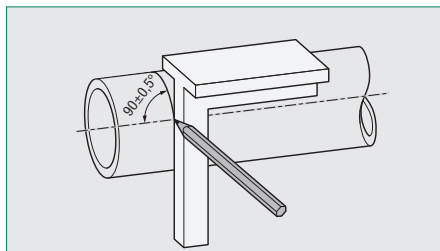

A maximum angular deviation / tolerance of  $\pm 0,5^\circ$  relative to the tube axis is permissible.

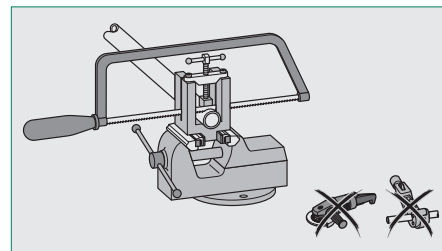

Only use proper tube sawing machinery or equipment. Do not use tube cutters or grinders as this may result in unwanted angled cuts and cause severe burring.

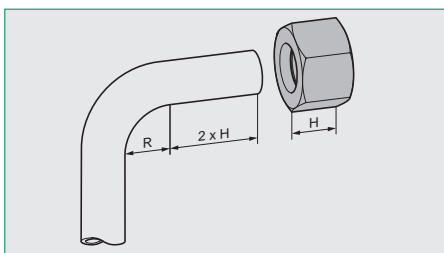

For tube bends, the length of the straight section of the tube end to the start of the bending radius has to be twice the height of the union nut.

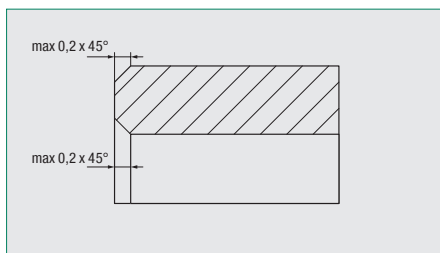

Slightly deburr inside and outside of the tube end (max  $0,2 \times 45^\circ$ ). The assembly area of the tube has to be free of contamination, chips and paint.



Please note: Improperly prepared and contaminated tubes will affect the service life of the connection and may result in leakage.

#### 2. Assembly Preparation, Machine-Assisted Assembly and Inspection

With regards to assembly preparation, the actual assembly as well as the inspection of assembled tube ends, please follow the detailed instructions in the operating manual of the machine.



#### 3. Assembly with the Fitting Body

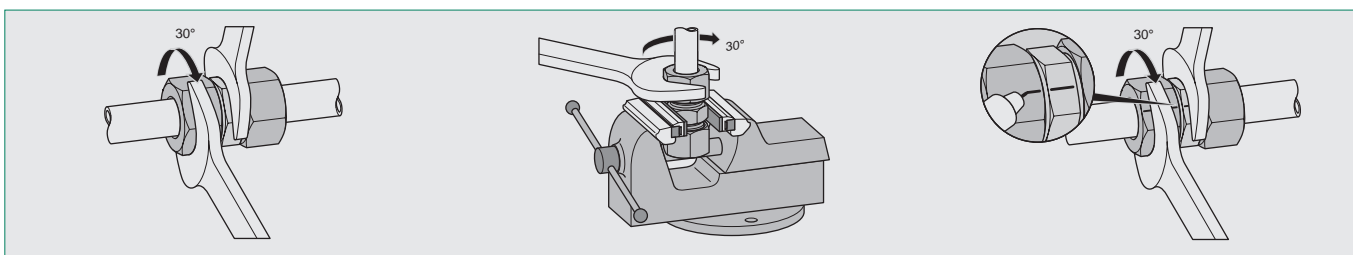

Carefully insert the assembled tube end into the 24° taper of the fitting body.

Use a suitable spanner to tighten the union nut until the noticeable increase in force, and then finish the assembly with another approximately 1/12 a turn (30°) beyond this point.

Always use a second spanner to hold the fitting body during the entire assembly procedure.

In case of unfavourable mounting conditions or larger tube dimensions, use a bench vice for the assembly.

A marking line applied on the union nut and the fitting body makes it easier to indicate the sufficient tightening angle.

#### 4. Repeated Assembly

For repeated assemblies, please use a suitable spanner to tighten the union nut until the noticeable increase in force, and then finish the assembly with another approximately 1/12 a turn (30°) beyond this point.

S





## Assembly Instructions for STAUFF Connect 24° Tube Fittings with Double Edge Cutting Ring (Type FI-DS)

### Machine-Assisted 50% Assembly with a STAUFF Press Assembly Machine and Assembly with the Fitting Body

#### 1. Tube Preparation

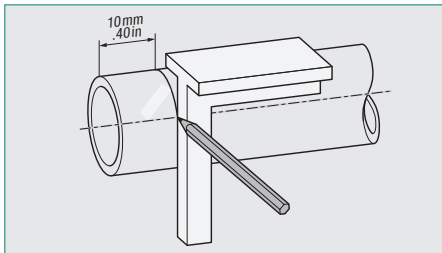

Saw off tube in right angle and at least 10 mm / .40 in from the cut made by the tube manufacturer / supplier in order to avoid failures caused during shipment.

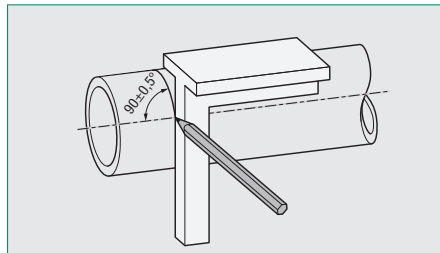

A maximum angular deviation / tolerance of  $\pm 0,5^\circ$  relative to the tube axis is permissible.

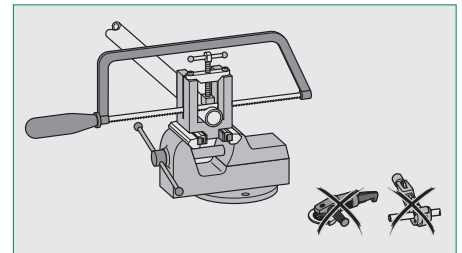

Only use proper tube sawing machinery or equipment. Do not use tube cutters or grinders as this may result in unwanted angled cuts and cause severe burring.

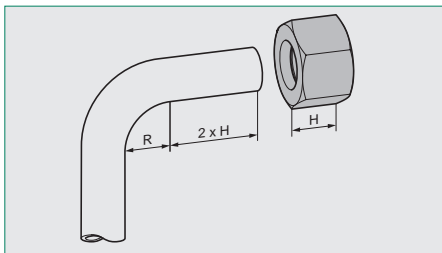

For tube bends, the length of the straight section of the tube end to the start of the bending radius has to be twice the height of the union nut.

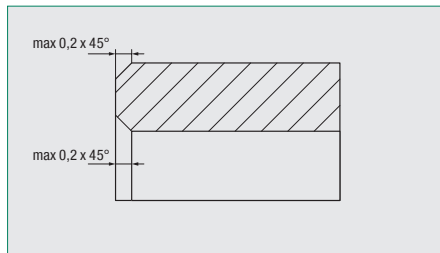

Slightly deburr inside and outside of the tube end (max  $0,2 \times 45^\circ$ ). The assembly area of the tube has to be free of contamination, chips and paint.

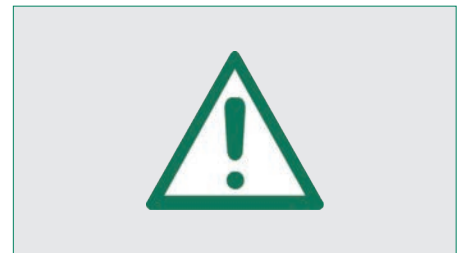

Please note: Improperly prepared and contaminated tubes will affect the service life of the connection and may result in leakage.

#### 2. Assembly Preparation, Machine-Assisted Assembly and Inspection

With regards to assembly preparation, the actual assembly as well as the inspection of assembled tube ends, please follow the detailed instructions in the operating manual of the machine.

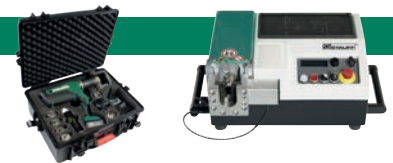

#### 3. Assembly with the Fitting Body

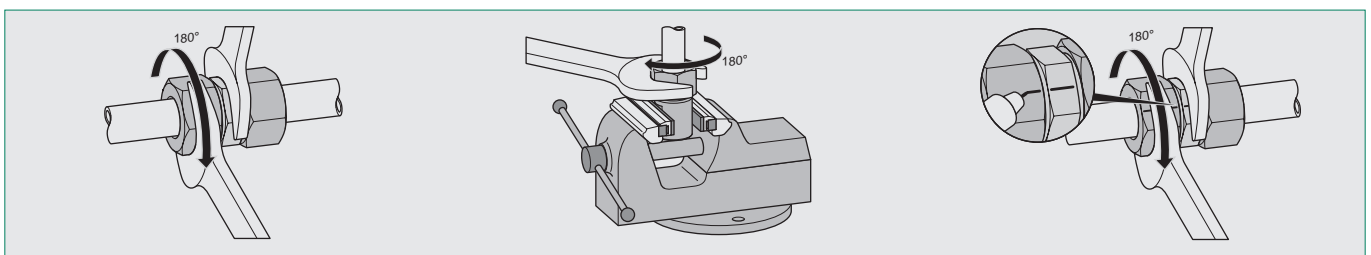

Carefully insert the assembled tube end into the 24° taper of the fitting body.

Use a suitable spanner to tighten the union nut until the noticeable increase in force, and then finish the assembly with another approximately 1/2 a turn (180°) beyond this point.

Always use a second spanner to hold the fitting body during the entire assembly procedure.

In case of unfavourable mounting conditions or larger tube dimensions, use a bench vice for the assembly.

A marking line applied on the union nut and the fitting body makes it easier to indicate the sufficient tightening angle.

#### 4. Repeated Assembly

For repeated assemblies, please use a suitable spanner to tighten the union nut until the noticeable increase in force, and then finish the assembly with another approximately 1/12 a turn (30°) beyond this point.

## Assembly Instructions for 24° Tube Connectors with Soft-Sealing Cutting Ring (Type FI-WDDS/FI-WDDS-W5)

100% Assembly with the Manual Final Assembly Stud Type FI-FK and Assembly in the Fitting Body

### 1. Tube Preparation

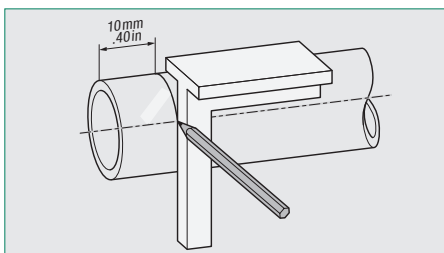

Saw off tube at a right angle (90°) and at least 10 mm from the cut made by the manufacture / supplier.

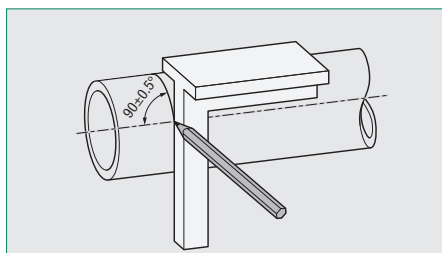

A maximum angular deviation of  $\pm 0.5^\circ$  to the tube axis is permissible.

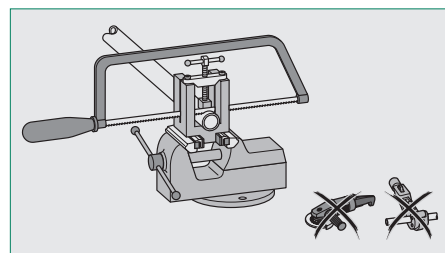

Do not use tube cutters or grinders.

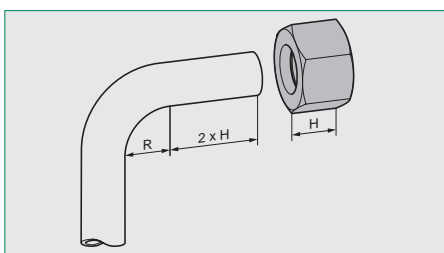

The length of the straight sections of the tube of tube bends has to be twice the length of the union nut.

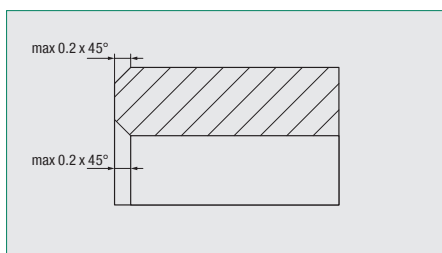

Slightly deburr the inside and outside of the tube end (max  $0.2 \times 45^\circ$ ). The assembly area of the tube has to be free of dirt, chips and paint.



Please note: Improperly prepared and contaminated tubes will affect the service life of the tube connectors and may result in leakage. Poorly deburred tube ends can result in damage to the internal O-ring!



Please note: Assembly of reinforcing sleeves is essential when using thin-walled tubes. Refer to page 304.

### 2. Assembly Preparation

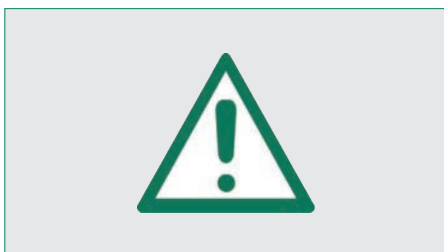

Hardened assembly studs are wear-resistant, thus allowing for consistent assembly results with a maximum degree of accuracy, reliability and process stability.

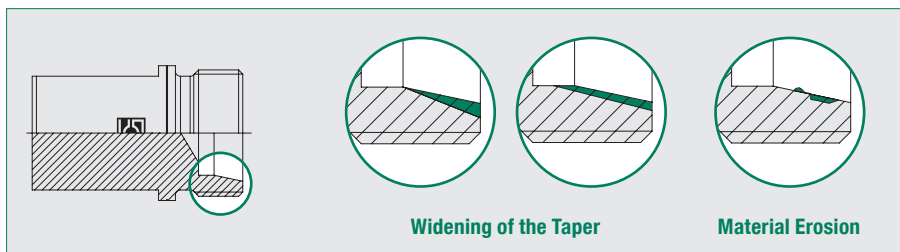

Assembly studs must be checked regularly for damage and dimensional accuracy. Replace assembly studs that are damaged and/or dimensionally inaccurate in all cases.

Typical damage includes the partial or complete widening of the 24° taper, as well as material erosion.

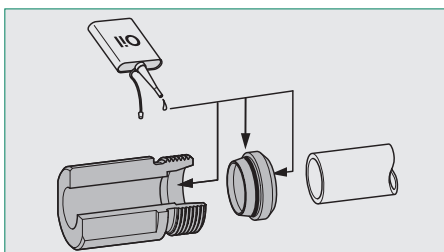

Please note when use FI-WDDS-W5 with Stainless Steel Fitting Body: Thread and 45° cone of the union nut and thread of the fitting body grease with special stainless steel fitting grease or use a silver coated union nut.

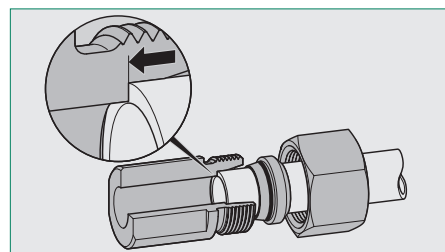
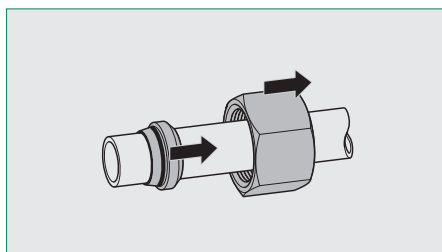

Lubricate the 24° taper of the assembly stud as well as the two soft-sealing elements of the cutting ring (e.g. using hydraulic oil HLP32). Do not use lubricating grease!

Consecutively push the union nut and then the cutting ring onto the tube end.

Carefully insert the tube end into the 24° taper of the assembly stud until it is flush with the stop.

Immediately proceed with assembly to avoid the adhesion of dirt.

Pay attention to the correct alignment of the cutting ring: the cutting edges of the cutting ring have to face the tube end.

The tube must be held in this position during the entire assembly process.



## Assembly Instructions for 24° Tube Connectors with Soft-Sealing Cutting Ring (Type FI-WDDS/FI-WDDS-W5)

### 100% Assembly with the Manual Final Assembly Stud Type FI-FK and Assembly in the Fitting Body

#### 3. Assembly in the Assembly Stud

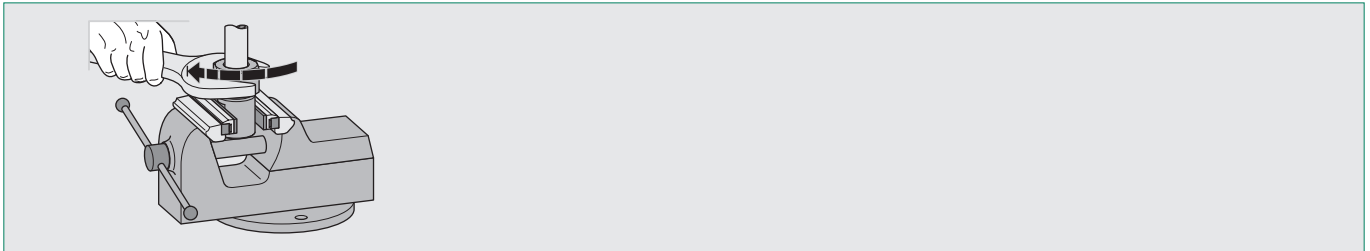

**!** Please note when use FI-WDDS-W5 with Stainless Steel Fitting Body: Thread and 45° cone of the union nut and thread of the fitting body grease with special stainless steel fitting grease or use a silver coated union nut.

Use a suitable spanner.  
Tighten the union nut to the point where there is a first increase in force, the pressure point.  
The pressure point defines the point at which the cutting ring starts gripping the tube.

The tube can then no longer be rotated in the fitting. Now tighten the union nut to the end of the assembly. The end of the assembly is situated approx. 1 to 1-1/4 turns (360° - 450°) beyond the pressure point and is signalled by a significant increase in force.

The cutting ring comes into contact with the face side of the fitting body.

#### 4. Inspection

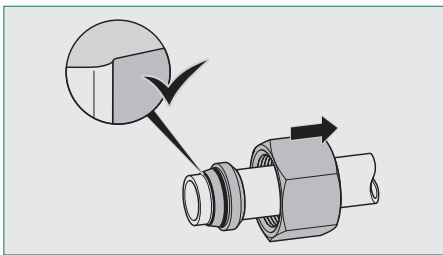

Fully loosen the union nut to visually inspect the assembly. There must be raised material clearly visible in front of the cutting edge.

Under certain circumstances, it is still possible at this time to turn the cutting ring on the tube (radial direction). It can no longer be moved in the direction of the tube (axial direction).

#### 5. Assembly with the Fitting Body

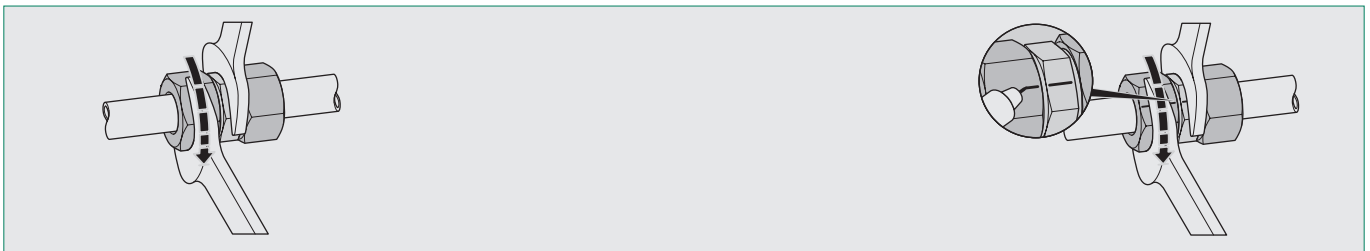

**!** Please note when use FI-WDDS-W5 with Stainless Steel Fitting Body: Thread and 45° cone of the union nut and thread of the fitting body grease with special stainless steel fitting grease or use a silver coated union nut.

Lightly lubricate the soft-sealing element located on the 24° taper of the cutting ring (e.g. using hydraulic oil HLP32). Do not use lubricating grease!

Immediately proceed with assembly to avoid the adhesion of dirt.

Carefully insert the assembled tube end into the 24° taper of the fitting body.

Tighten the union nut to the point where there is a first increase in force. Then tighten the union nut to the end of the assembly.

The cutting ring comes into contact with the face side of the fitting body after approx. 90° - 150°. The end of the assembly is once again indicated by a significant increase in force.

Use a suitable spanner to hold the fitting body within the tube during the entire assembly process. Use a bench vice for assembly in the event of unfavourable assembly conditions or larger tube dimensions.

A marking line on the union nut and the fitting body makes it easier to note and check the correct tightening angle.

#### 6. Repeated Assembly

Check the soft-sealing element located on the 24° taper of the cutting ring for possible damage.

Carefully insert the tube end into the 24° taper of the fitting body.

Then tighten the union nut to the end of the assembly. The cutting ring comes into contact with the face side of the fitting body after approx. 90° - 150°. The end of the assembly is once again indicated by a significant increase in force.



## Assembly Instructions for 24° Tube Connectors with Soft-Sealing Cutting Ring (Type FI-WDDS/FI-WDDS-W5) Direct Assembly in the Fitting Body

### 1. Tube Preparation

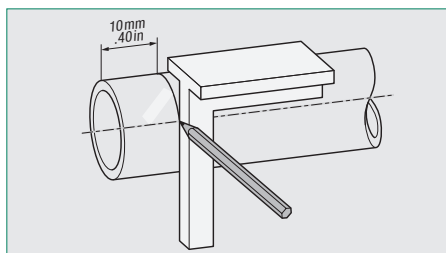

Saw off tube at a right angle (90°) and at least 10 mm from the cut made by the manufacture / supplier.

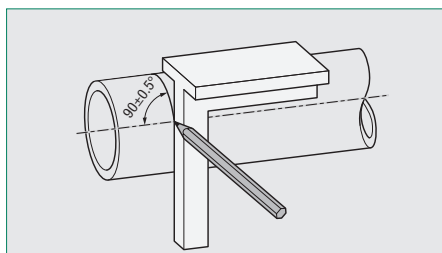

A maximum angular deviation of  $\pm 0.5^\circ$  to the tube axis is permissible.

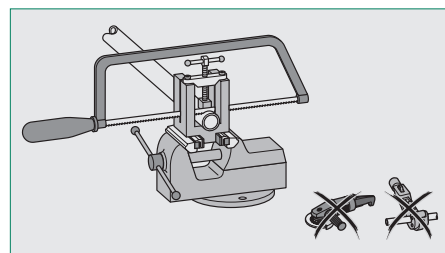

Do not use tube cutters or grinders.

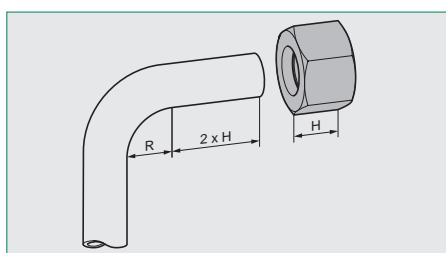

The length of the straight sections of the tube of tube bends has to be twice the length of the union nut.

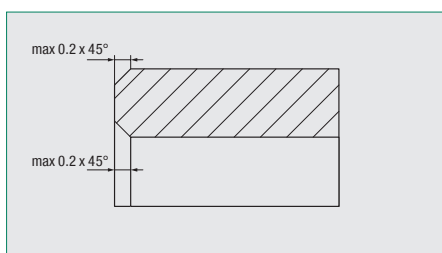

Slightly deburr the inside and outside of the tube end (max 0.2 x 45°). The assembly area of the tube has to be free of dirt, chips and paint.

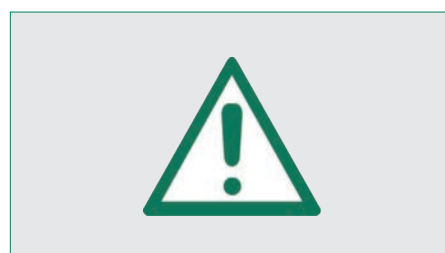

Please note: Improperly prepared and contaminated tubes will affect the service life of the tube connectors and may result in leakage. Poorly deburred tube ends can result in damage to the internal O-ring!



Please note: Assembly of reinforcing sleeves is essential when using thin-walled tubes. Refer to page 304.

### 2. Assembly Preparation

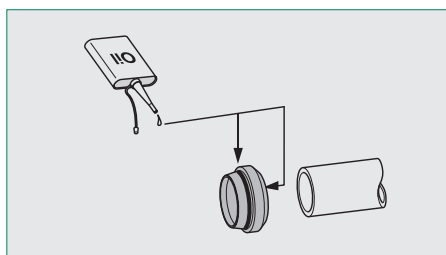

Lightly lubricate the two soft-sealing elements of the cutting ring (e.g. using hydraulic oil HLP32). Do not use lubricating grease!

Immediately proceed with assembly to avoid the adhesion of dirt.

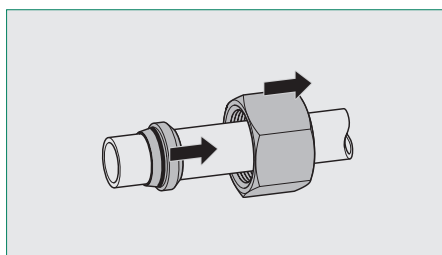

Consecutively push the union nut and then the cutting ring onto the tube end.

Pay attention to the correct alignment of the cutting ring: the cutting edges of the cutting ring have to face the tube end.

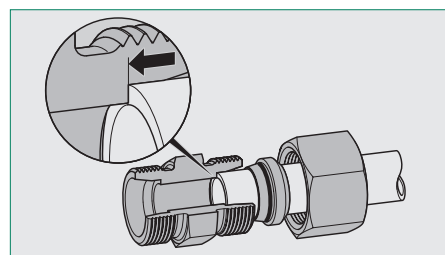

Carefully insert the tube end into the 24° taper of the fitting body until it is flush with the stop.

The tube must be held in this position during the entire assembly process.



## Assembly Instructions for 24° Tube Connectors with Soft-Sealing Cutting Ring (Type FI-WDDS/FI-WDDS-W5) Direct Assembly in the Fitting Body

### 3. Assembly in the Fitting Body

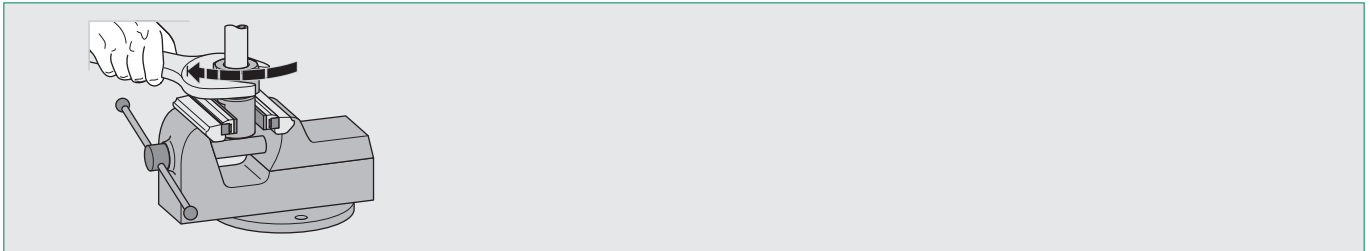

Please note when use FI-WDDS-W5 with Stainless Steel Fitting Body: Thread and 45° cone of the union nut and thread of the fitting body grease with special stainless steel fitting grease or use a silver coated union nut.

Use a suitable spanner. Tighten the union nut to the point where there is a first increase in force, the pressure point. The pressure point defines the point at which the cutting ring starts gripping the tube.

The tube can then no longer be rotated in the fitting. Now tighten the union nut to the end of the assembly. The end of the assembly is situated approx. 1 to 1-1/4 turns (360° - 450°) beyond the pressure point and is

signalled by a significant increase in force. The cutting ring comes into contact with the face side of the fitting body.

### 4. Inspection

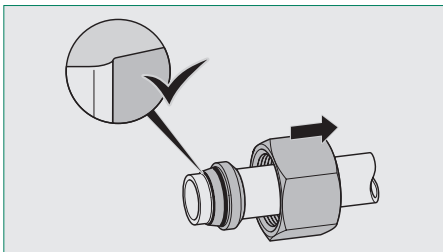

Fully loosen the union nut to visually inspect the assembly. There must be raised material clearly visible in front of the cutting edge.

Under certain circumstances, it is still possible at this time to turn the cutting ring on the tube (radial direction). It can no longer be moved in the direction of the tube (axial direction).

### 5. Assembly with the Fitting Body

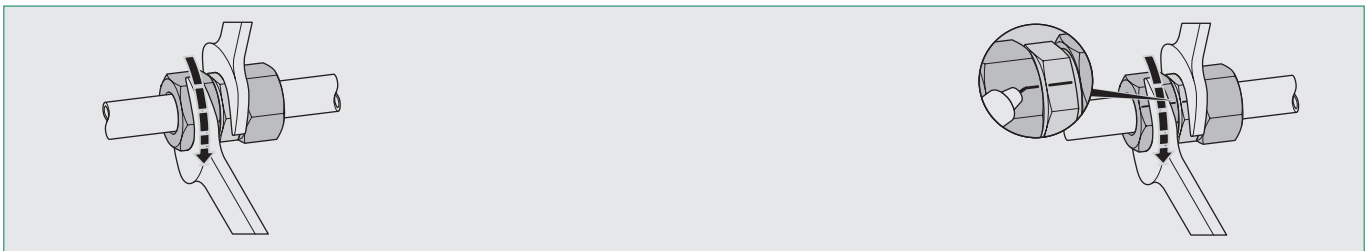

Please note when use FI-WDDS-W5 with Stainless Steel Fitting Body: Thread and 45° cone of the union nut and thread of the fitting body grease with special stainless steel fitting grease or use a silver coated union nut.

Lightly lubricate the soft-sealing element located on the 24° taper of the cutting ring (e.g. using hydraulic oil HLP32). Do not use lubricating grease!

Immediately proceed with assembly to avoid the adhesion of dirt.

Carefully insert the assembled tube end into the 24° taper of the fitting body.

Tighten the union nut to the point where there is a first increase in force. Then tighten the union nut to the end of the assembly.

The cutting ring comes into contact with the face side of the fitting body after approx. 90° - 150°. The end of the assembly is once again indicated by a significant increase in force.

Use a suitable spanner to hold the fitting body within the tube during the entire assembly process. Use a bench vice for assembly in the event of unfavourable assembly conditions or larger tube dimensions.

A marking line on the union nut and the fitting body makes it easier to note and check the correct tightening angle.

### 6. Repeated Assembly

Check the soft-sealing element located on the 24° taper of the cutting ring for possible damage.

Carefully insert the tube end into the 24° taper of the fitting body.

Then tighten the union nut to the end of the assembly. The cutting ring comes into contact with the face side of the fitting body after approx. 90° - 150°. The end of the assembly is once again indicated by a significant increase in force.



## Assembly Instructions for 24° Tube Connectors with Soft-Sealing Cutting Ring (Type FI-WDDS/FI-WDDS-W5) Machine-Assisted 100% Assembly with a STAUFF Press Assembly Machine and Assembly with the Fitting Body

### 1. Tube Preparation

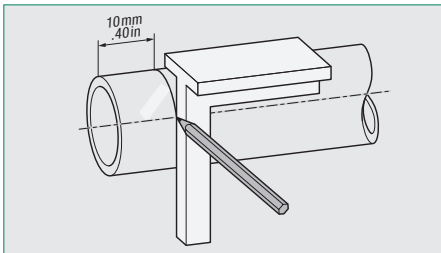

Saw off tube at a right angle (90°) and at least 10 mm from the cut made by the manufacture / supplier.

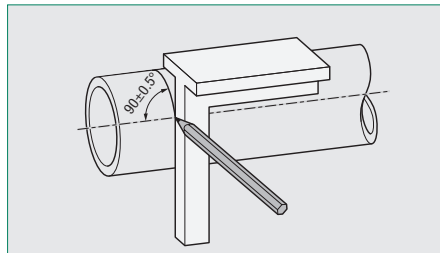

A maximum angular deviation of  $\pm 0.5^\circ$  to the tube axis is permissible.

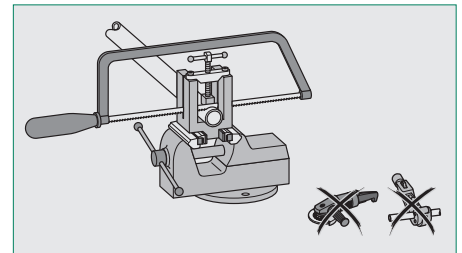

Do not use tube cutters or grinders.

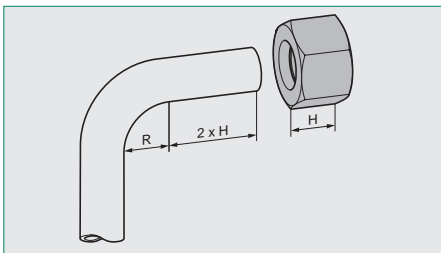

The length of the straight sections of the tube of tube bends has to be twice the length of the union nut.

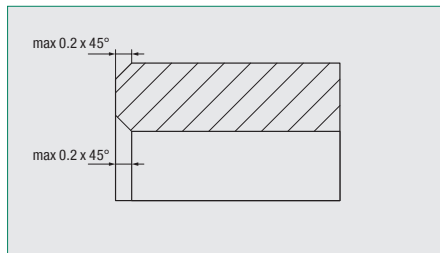

Slightly deburr the inside and outside of the tube end (max  $0.2 \times 45^\circ$ ). The assembly area of the tube has to be free of dirt, chips and paint.

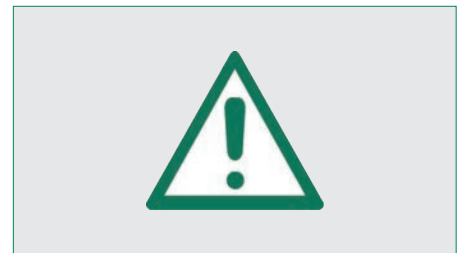

Please note: Improperly prepared and contaminated tubes will affect the service life of the tube connectors and may result in leakage. Poorly deburred tube ends can result in damage to the internal O-ring!



Please note: Assembly of reinforcing sleeves is essential when using thin-walled tubes. Refer to page 304.

### 2. Assembly Preparation, Machine-Assisted Assembly and Inspection

Please refer to the detailed instructions in the operating manual for the machine with regard to assembly preparation, actual assembly and inspection of the assembled tube ends.



### 3. Assembly with the Fitting Body

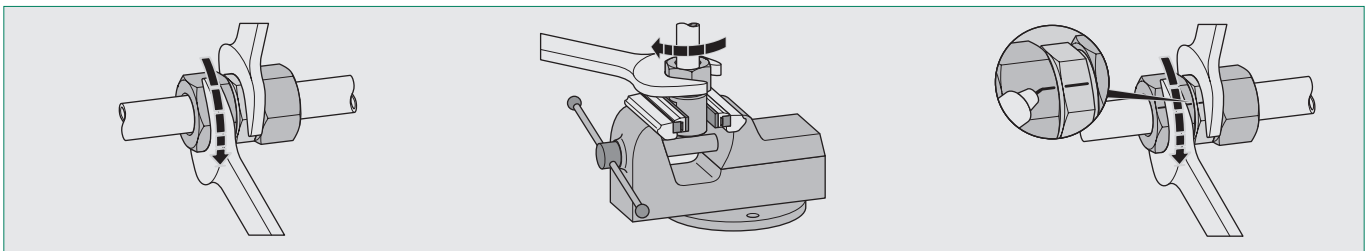

Please note when use FI-WDDS-W5 with Stainless Steel Fitting Body: Thread and  $45^\circ$  cone of the union nut and thread of the fitting body grease with special stainless steel fitting grease or use a silver coated union nut.

Lightly lubricate the soft-sealing element located on the  $24^\circ$  taper of the cutting ring (e.g. using hydraulic oil HLP32). Do not use lubricating grease!

Immediately proceed with assembly to avoid the adhesion of dirt.

Carefully insert the assembled tube end into the  $24^\circ$  taper of the fitting body.

Tighten the union nut to the point where there is a first increase in force. Then tighten the union nut to the end of the assembly.

The cutting ring comes into contact with the face side of the fitting body after approx.  $90^\circ - 150^\circ$ . The end of the assembly is once again indicated by a significant increase in force.

Use a suitable spanner to hold the fitting body within the tube during the entire assembly process. Use a bench vice for assembly in the event of unfavourable assembly conditions or larger tube dimensions.

A marking line on the union nut and the fitting body makes it easier to note and check the correct tightening angle.

### 6. Repeated Assembly

Check the soft-sealing element located on the  $24^\circ$  taper of the cutting ring for possible damage.

Carefully insert the tube end into the  $24^\circ$  taper of the fitting body.

Then tighten the union nut to the end of the assembly. The cutting ring comes into contact with the face side of the fitting body after approx.  $90^\circ - 150^\circ$ . The end of the assembly is once again indicated by a significant increase in force.



Please note when use FI-WDDS-W5 with Stainless Steel Fitting Body: Thread and  $45^\circ$  cone of the union nut and thread of the fitting body grease with special stainless steel fitting grease or use a silver coated union nut.



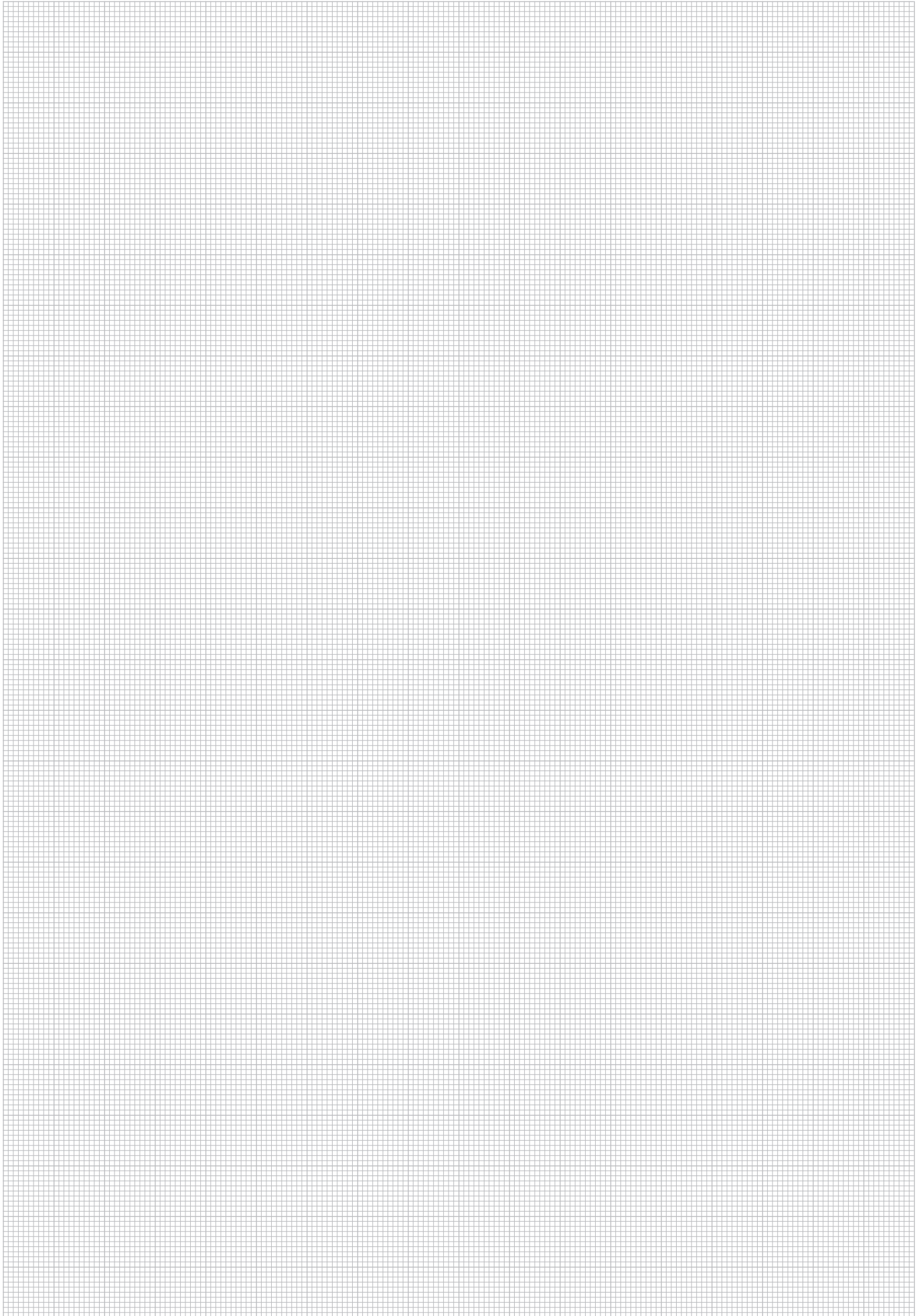

S



## Assembly Instructions for Support Sleeves (Type FI-VH)

### Selection Chart for Tubes made of Steel / Stainless Steel

Series	Tube OD		Tube Wall Thickness										
	(mm)	(in)	(mm)	0,5	0,75	1,0	1,5	2,0	2,5	3,0	3,5	4,0	
LL	4	.16											
	6	.24	●										
	8	.31	●										
L	6	.24	●	●									
	8	.31	●	●									
	10	.39	●	●									
	12	.47	●	●	○								
	15	.59	●	●	●								
	18	.71	●	●	●	○							
	22	.87	●	●	●	○	○						
	28	1.10	●	●	●	○	○						
	35	1.38	●	●	●	●	○	○					
	42	1.65	●	●	●	●	○	○					
S	6	.24	●	●									
	8	.31	●	●									
	10	.39	●	●									
	12	.47	●	●	○								
	14	.55	●	●	●								
	16	.63	●	●	●	○							
	20	.79	●	●	●	●	○						
	25	.98	●	●	●	●	○						
	30	1.18	●	●	●	●	●	○					
	38	1.50	●	●	●	●	●	●	○	○			

### Selection Chart for Tubes made of Non-Ferrous Metals

Series	Tube OD		Tube Wall Thickness										
	(mm)	(in)	(mm)	0,5	0,75	1,0	1,5	2,0	2,5	3,0	3,5	4,0	
LL	4	.16											
	6	.24	●	●									
	8	.31	●	●									
L	6	.24	●	●	●								
	8	.31	●	●	●								
	10	.39	●	●	●	○							
	12	.47	●	●	●	●							
	15	.59	●	●	●	●							
	18	.71	●	●	●	●	●						
	22	.87	●	●	●	●	●	●					
	28	1.10	●	●	●	●	●	●	●				
	35	1.38	●	●	●	●	●	●	●	●			
	42	1.65	●	●	●	●	●	●	●	●	●		
S	6	.24	●	●	●								
	8	.31	●	●	●								
	10	.39	●	●	●								
	12	.47	●	●	●								
	14	.55	●	●	●	●							
	16	.63	●	●	●	●	●						
	20	.79	●	●	●	●	●	●					
	25	.98	●	●	●	●	●	●	●				
	30	1.18	●	●	●	●	●	●	●	●			
	38	1.50	●	●	●	●	●	●	●	●	●		

● Generally required ○ Highly recommended, especially for adverse operating conditions (vibrations, risks of self-loosening of fittings etc.)

Support sleeves are generally required for use with tubes made of plastics.

### Assembly

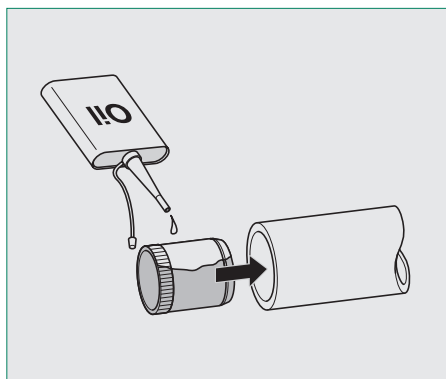

Lubricate the outside of the support sleeve (e.g. using mineral-oil based hydraulic fluid HLP32) and insert it into the tube end up to the knurled section.

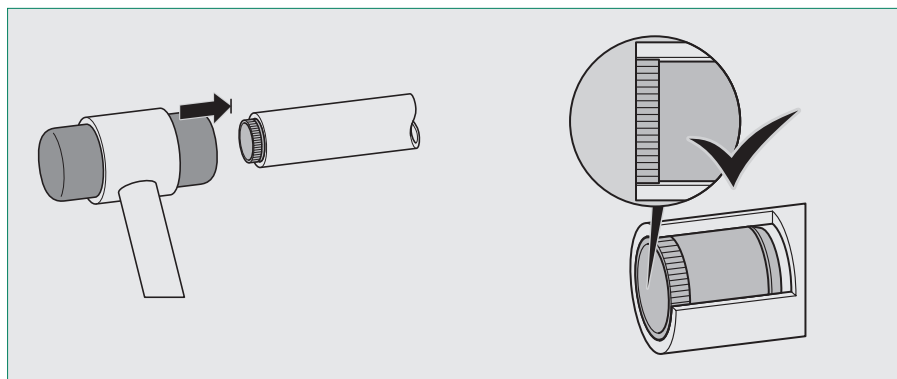

Use a hammer (plastic or rubber) to fully drive the support sleeve into the tube end, so that the knurled section is pressed against the inner wall of the tube and the sleeve is firmly flush with the tube end.

In doing so, the support sleeve is prevented from subsequent turning, sliding and falling out.

S





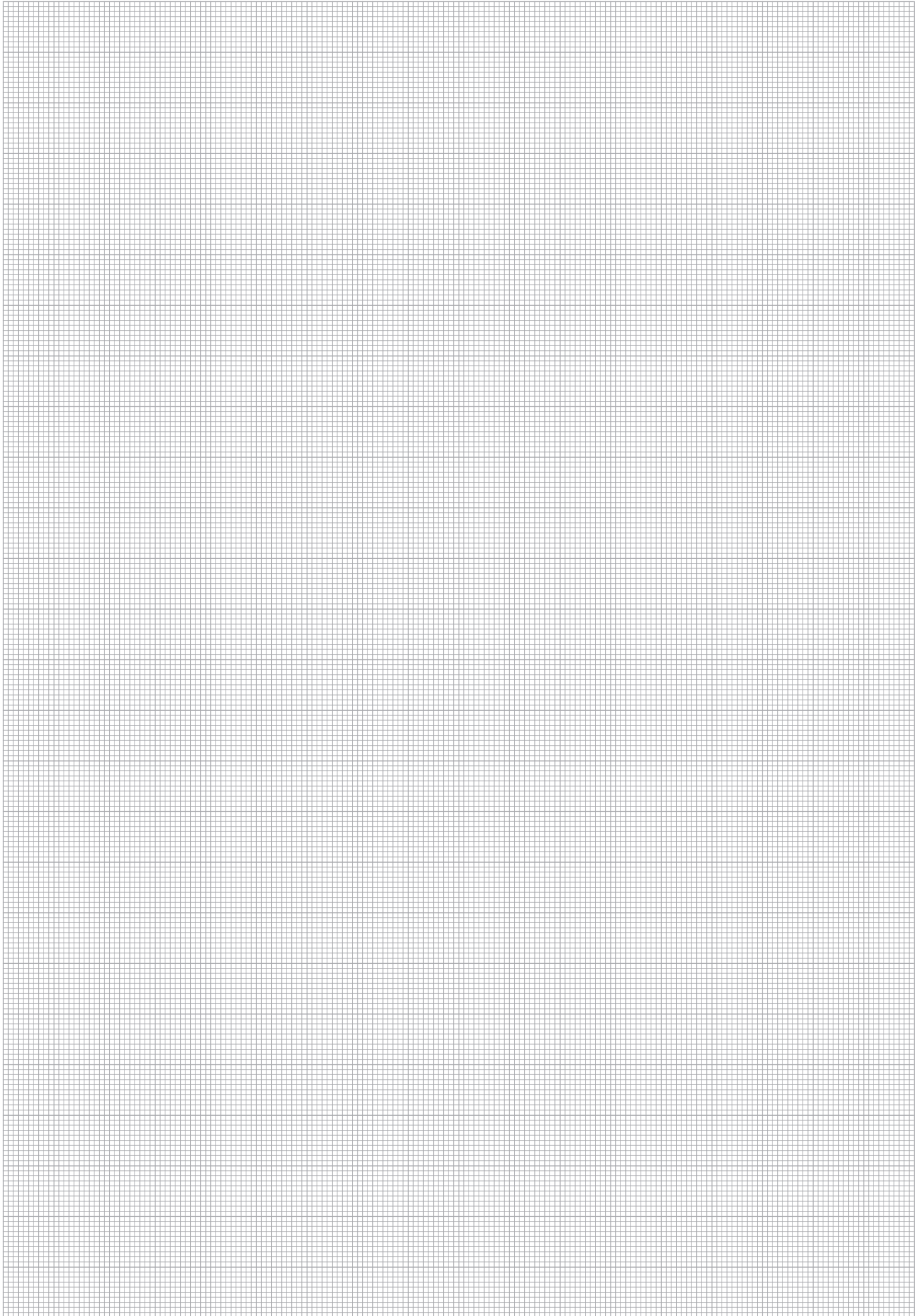

S



## Assembly Instructions for STAUFF Form EVO Tube Fittings

### Tube End Forming with a STAUFF Form EVO Machine and Assembly with the Fitting Body

#### 1. Tube Preparation

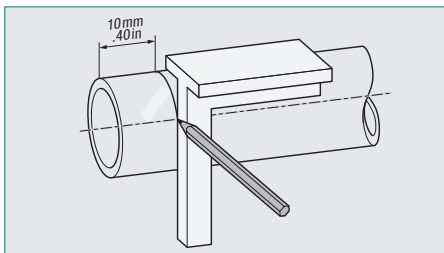

Saw off tube in right angle and at least 10 mm / .40 in from the cut made by the tube manufacturer / supplier in order to avoid failures caused during shipment.

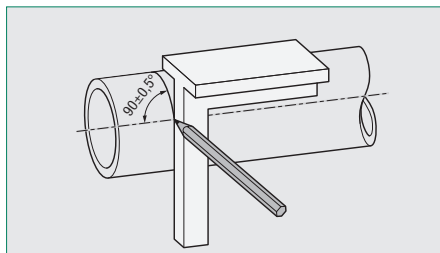

A maximum angular deviation / tolerance of  $\pm 0,5^\circ$  relative to the tube axis is permissible.

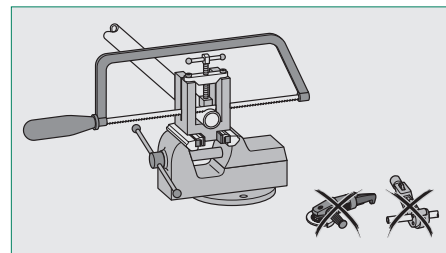

Only use proper tube sawing machinery or equipment. Do not use tube cutters or grinders as this may result in unwanted angled cuts and cause severe burring.

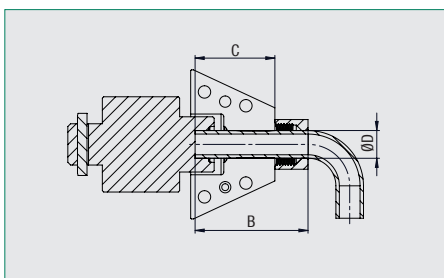
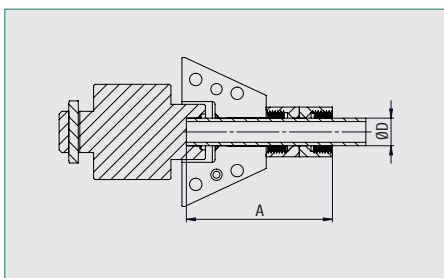

Series	Tube OD		Minimum Length A		Minimum Length B		Insertion Depth C	
	(mm)	(in)	Straight Tube Ends		Straight Sections next to Tube Bends		incl. 10 mm Door thickness	
			(mm)	(in)	(mm)	(in)	(mm)	(in)
L	6	.24	75	2.95	52	2.05	52	2.05
	8	.31	75	2.95	52	2.05	52	2.05
	10	.39	74	2.91	52	2.05	52	2.05
	12	.47	75	2.95	54	2.13	54	2.13
	15	.59	89	3.50	66	2.60	59	2.32
	18	.71	99	3.90	74	2.91	67	2.64
	22	.87	106	4.17	82	3.23	72	2.83
	28	1.10	112	4.41	87	3.43	75	2.95
S	6	.24	77	3.03	54	2.13	54	2.05
	8	.31	77	3.03	54	2.13	52	2.05
	10	.39	77	3.03	54	2.13	52	2.05
	12	.47	78	3.07	56	2.20	54	2.13
	16	.63	98	3.86	72	2.83	61	2.40
	20	.79	115	4.53	84	3.31	70	2.76
	25	.98	129	5.08	96	3.78	79	3.11
	30	1.18	148	5.83	111	4.37	82	3.23
	38	1.50	170	6.69	126	4.96	94	3.70

Please note the minimum lengths for straight tube ends (dimension A) as well as for straight tube sections next to tube bends (dimension B) that are listed in the table.

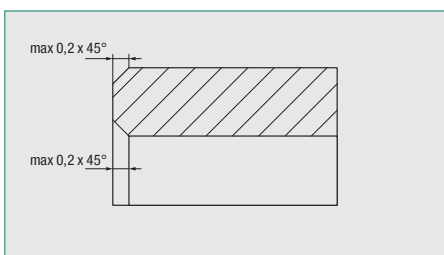

Slightly deburr inside and outside of the tube end (max 0,2 x 45°). The assembly area of the tube has to be free of contamination, chips and paint.

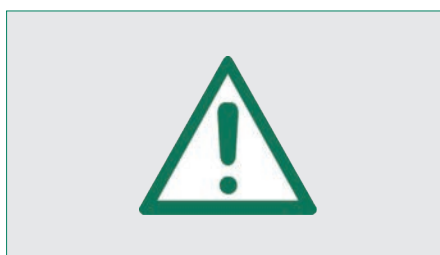

Please note: Improperly prepared and contaminated tubes will affect the service life of the connection and may result in leakage.



#### 2. Preparation and Machine-Assisted Tube Forming

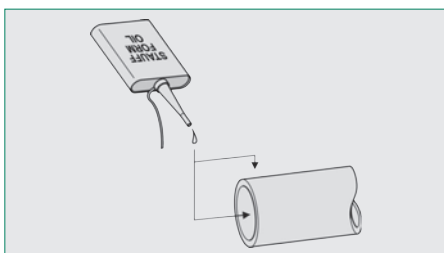

Lightly lubricate the inside and outside of the tube end (e.g. with a thin film of mineral-oil based hydraulic fluid HLP32) before starting the machine-assisted tube forming process. Do not use lubricating grease!

**Important: For tube ends made of stainless steel, always and only use original STAUFF Form EVO Oil. The use of any other fluid is not allowed and may result in damage of the assembly tools.**

Immediately proceed with the assembly in order to avoid exposure to contamination.

If the lubricant film on the outside of the tube end is too thick, fluid will be trapped between the forming tool and the tube end, thus resulting in inaccurate contours.

With regards to the actual tube forming process, please follow the detailed instructions in the operating manual of the machine.



## Assembly Instructions for STAUFF Form EVO Tube Fittings

### Tube End Forming with a STAUFF Form EVO Machine and Assembly with the Fitting Body

#### 3. Inspection

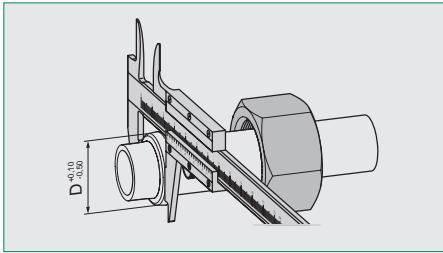

Use a suitable measuring device (caliper gauge) to check control diameter D of the formed tube end based on the dimension table on the right.

Series	Tube OD		Dimensions D	
	(mm)	(in)	(mm)	(in)
L	6	.24	9,5	.37
	8	.31	12,1	.48
	10	.39	14,0	.55
	12	.47	16,1	.63
	15	.59	20,1	.79
	18	.71	23,7	.93
	22	.87	27,1	1.07
	28	1.10	33,1	1.30
	35	1.38	42,1	1.66
	42	1.65	49,4	1.94
S	6	.24	9,5	.37
	8	.31	12,1	.48
	10	.39	14,0	.55
	12	.47	16,1	.63
	16	.63	21,7	.85
	20	.79	26,1	1.03
	25	.98	31,1	1.22
	30	1.18	37,1	1.46
	38	1.50	46,9	1.85

#### 4. Assembly with the Fitting Body

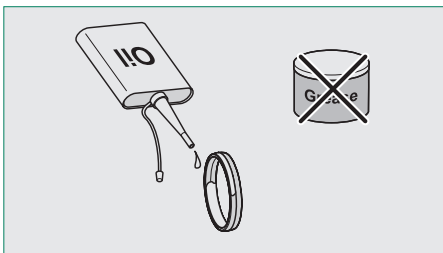

Lightly lubricate the inside and outside of the sealing element of the form ring (e.g. using mineral-oil based hydraulic fluid HLP32). Do not use lubricating grease!

Immediately proceed with the assembly in order to avoid exposure to contamination.

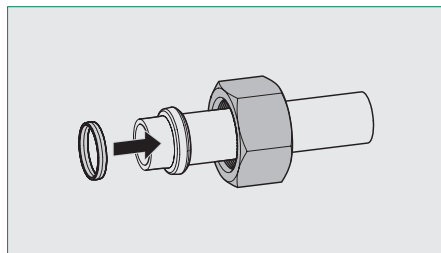

Slide the sealing ring onto the formed tube end (laterally identical profile to avoid assembly errors).

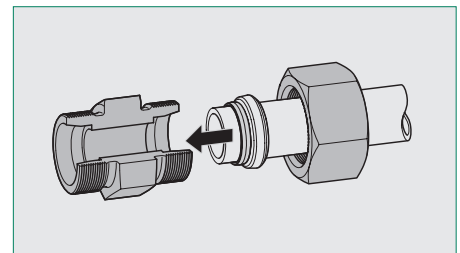

Carefully insert the formed tube end with the assembled sealing into the 24° taper of the fitting body.

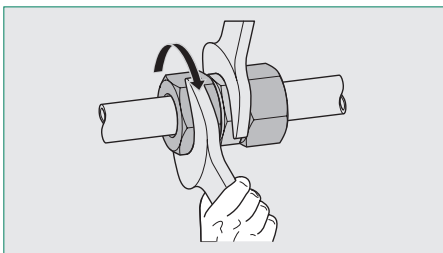

Use a suitable spanner to tighten the nut until there is a noticeable increase in force required (fixed point).

Avoid over-tightening by gripping the spanner close to the union nut.

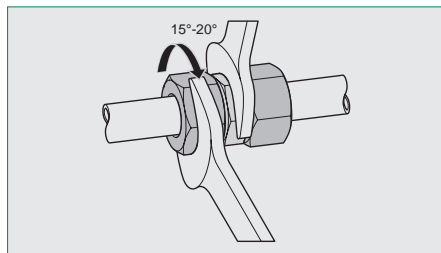

Finish the assembly by using a suitable spanner to tighten the union nut approximately 15-20° beyond the fixed point. Always use a second spanner to hold the fitting body during the entire assembly procedure.

Alternatively, the assembly can be done via a torque.  
**Table with torques see point 6.**

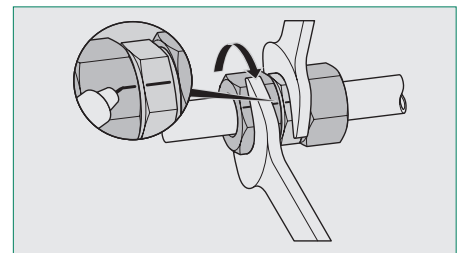

A marking line applied on the union nut and the fitting body makes it easier to indicate the sufficient tightening angle.



Please note when using stainless steel components: Thread and 45° cone of the union nut and thread of the fitting body grease with special stainless steel fitting grease or use a silver coated union nut.

#### 5. Repeated Assembly

For repeated assemblies, please follow the instructions from point 4 on.



**S**

## Assembly Instructions for STAUFF Form EVO Tube Fittings

### Tube End Forming with a STAUFF Form Machine and Assembly with the Fitting Body

#### 6. Torques for alternative assembly for STAUFF Form EVO Tube Fittings

Series	Tube OD (mm/in)	Dimensions (mm/in) Thread	Turn till increase in force (fix point), than Assembly Angle	Torque (N·m/lb.ft)
L	6	M 12 x 1,5	15° ... 20°	23
	.24			17
	8	M 14 x 1,5		32
	.31			23.6
	10	M 16 x 1,5		40
	.39			29.5
	12	M 18 x 1,5		50
	.47			36.9
	15	M 22 x 1,5		65
	.59			47.9
	18	M 26 x 1,5		110
	.71			81.1
	22	M 30 x 2		120
	.87			88.5
	28	M 36 x 2		160
1.10	118			
35	M 45 x 2	275		
1.38		202.8		
42	M 52 x 2	410		
1.65		302.4		
S	6	M 14 x 1,5	30	
	.24		22.1	
	8	M 16 x 1,5	40	
	.31		29.5	
	10	M 18 x 1,5	55	
	.39		40.6	
	12	M 20 x 1,5	60	
	.47		44.3	
	16	M 24 x 1,5	85	
	.63		62.7	
	20	M 30 x 2	160	
	.79		118	
	25	M 36 x 2	200	
	.98		147.5	
	30	M 42 x 2	270	
1.18	199.1			
38	M52 x 2	400		
1.50		295		



## Assembly Instructions for STAUFF Form EVO Tube Fittings

### Tube End Forming with a STAUFF Form EVO Machine and Assembly with the Fitting Body

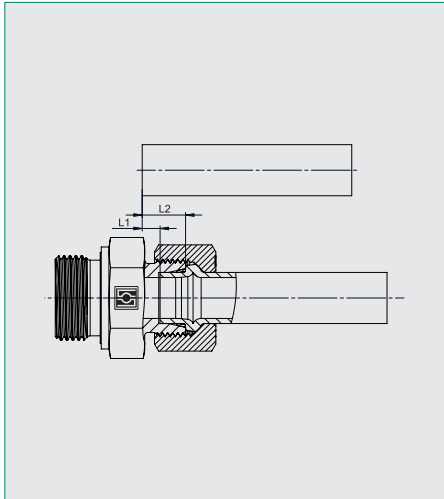
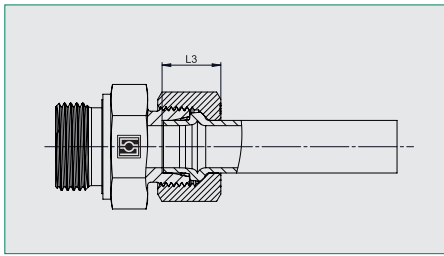
**Calculation Dimensions**

Tube OD		Tube Wall Thickness		L1		L2		L3	
(mm)	(in)	(mm)	(in)	(mm)	(in)	(mm)	(in)	(mm)	(in)
6	.24	1,5	.06	7,3	.29	13,8	.54	14,6 (L+S)	.57 (L+S)
8	.31	1,5	.06	7,5	.30	14,0	.55	14,6 (L+S)	.57 (L+S)
		2,0	.08	7,1	.28	13,6	.54		
		2,5	.10	6,6	.26	13,1	.52		
10	.39	1,5	.06	6,0	.24	12,4	.49	14,5 (L)	.57 (L+S)
		2,0	.08	6,3	.25	12,7	.50		
		2,5	.10	6,0	.24	12,4	.49	15,5 (S)	.61 (L+S)
		3,0	.12	5,7	.22	12,1	.48		
12	.47	1,5	.06	5,2	.20	11,7	.46	14,6 (L)	.57 (L)
		2,0	.08	5,4	.21	11,9	.47		
		2,5	.10	5,1	.20	11,6	.46	15,6 (S)	.61 (L+S)
		3,0	.12	4,9	.19	11,4	.45		
15	.59	1,5	.06	6	.24	12,5	.49	15,6	.61
		2,0	.08	6,4	.25	12,9	.51		
		2,5	.10	6,4	.25	12,9	.51		
16	.63	2,0	.08	7,4	.29	15,3	.60	18,4	.72
		2,5	.10	7,0	.28	14,9	.59		
		3,0	.12	7,0	.28	14,9	.59		
		4,0	.16	6,2	.24	14,1	.56		
18	.71	1,5	.06	6,2	.24	14,1	.56	16,4	.65
		2,0	.08	6,8	.27	13,7	.54		
		2,5	.10	6,5	.26	13,4	.53		
		3,0	.12	6,8	.27	13,7	.54		
20	.79	2,0	.08	7,7	.30	17,7	.70	21,6	.85
		2,5	.10	7,8	.31	17,8	.70		
		3,0	.12	7,7	.30	17,7	.70		
		4,0	.16	7,3	.29	17,3	.68		
22	.87	2,0	.08	5,5	.22	12,5	.49	17,5	.69
		2,5	.10	5,7	.22	12,7	.50		
		3,0	.12	5,8	.23	12,8	.50		
		3,5	.14	5,9	.23	12,9	.51		
25	.98	2,0	.08	7,1	.28	18,6	.73	24,5	.96
		2,5	.10	7,6	.30	19,1	.75		
		3,0	.12	7,7	.30	19,2	.76		
		3,5	.14	7,7	.30	19,2	.76		
		4,0	.16	7,8	.31	19,3	.76		
		5,0	.20	7,8	.31	19,3	.76		
28	1.10	2,0	.08	5,4	.21	12,4	.49	18	.71
		2,5	.10	5,8	.23	12,8	.50		
		3,0	.12	5,7	.22	12,7	.50		
		3,5	.14	5,3	.21	12,3	.48		
30	1.18	4,0	.16	6,2	.24	13,2	.52	27,2	1.07
		2,5	.10	7,9	.31	20,8	.82		
		3,0	.12	8,0	.31	20,9	.82		
		4,0	.16	8,2	.32	21,1	.83		
		5,0	.20	8,5	.33	21,4	.84		
35	1.38	6,0	.24	8,2	.32	21,1	.83	22	.87
		2,5	.10	7,7	.30	17,6	.69		
		3,0	.12	7,8	.31	17,7	.70		
		4,0	.16	8,6	.34	18,5	.73		
38	1.50	5,0	.20	8,7	.34	18,6	.73	31	1.22
		3,0	.12	9,8	.39	25,2	.99		
		4,0	.16	11,0	.43	26,4	1.4		
		6,0	.24	11,4	.45	26,8	1.6		
42	1.65	3,0	.12	8,1	.32	18,5	.73	22,7	.89
		3,5	.14	7,9	.31	18,3	.72		
		4,0	.16	8,6	.34	19,0	.75		

**S**

## Assembly Instructions for STAUFF Connect 37° Flared Tube Fittings

### Tube Flaring with a STAUFF Press Machine and Assembly with the Fitting Body

#### 1. Tube Preparation

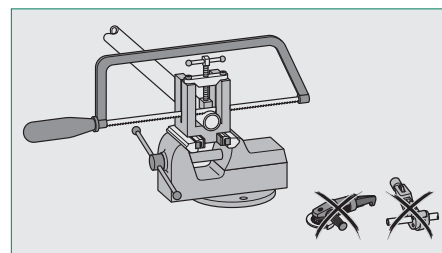
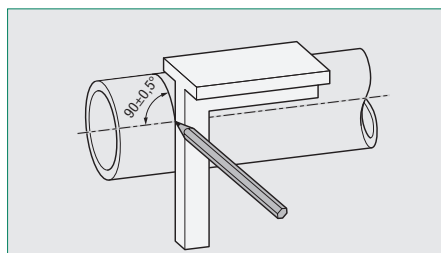
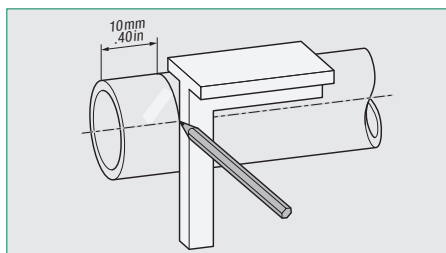

Saw off tube in right angle and at least 10 mm / .40 in from the cut made by the tube manufacturer / supplier in order to avoid failures caused during shipment.

A maximum angular deviation / tolerance of  $\pm 0,5^\circ$  relative to the tube axis is permissible.

Only use proper tube sawing machinery or equipment. Do not use tube cutters or grinders as this may result in unwanted angled cuts and cause severe burring.

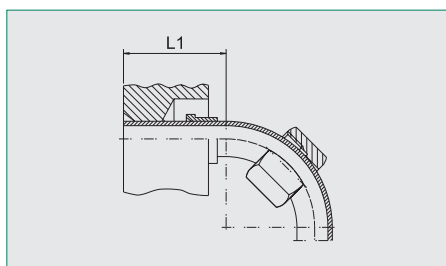
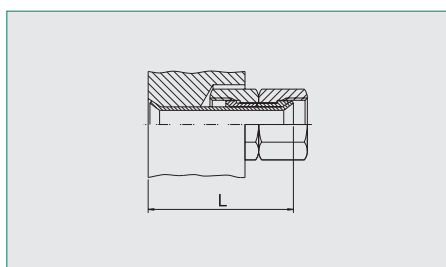

Series	Tube OD		Minimum Length L Straight Tube Sections		Minimum Length L1 Straight Tube Sections next to Tube Bends	
	(mm)	(in)	(mm)	(in)	(mm)	(in)
L	6	.24	59	2.32	43	1.69
	8	.31	62	2.44	44	1.73
	10	.39	64	2.52	46	1.81
	12	.47	67	2.64	47	1.85
	15	.59	75	2.95	50	1.97
	18	.71	76	2.99	58	2.28
	22	.87	81	3.19	60	2.36
	28	1.10	88	3.46	60	2.36
	35	1.38	92	3.62	62	2.44
	42	1.65	130	5.12	70	2.76
S	6	.24	61	2.40	43	1.69
	8	.31	64	2.52	44	1.73
	10	.39	66	2.60	46	1.81
	12	.47	68	2.68	47	1.85
	16	.63	79	3.11	52	2.05
	20	.79	82	3.23	58	2.28
	25	.98	94	3.70	60	2.36
	30	1.18	96	3.78	62	2.44
38	1.50	136	5.35	70	2.76	

Please note the minimum lengths for straight tube ends (dimension L) as well as for straight tube sections next to tube bends (dimension L1) that are listed in the table. If installation situations demand that the length of straight tube sections next to tube bends (dimension L1) has to be shorter than indicated in the table, tube bending has to be carried out after flaring.

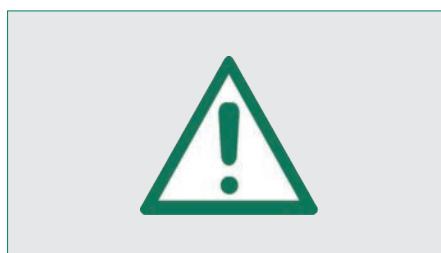
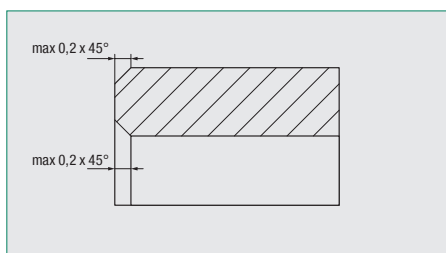

Slightly deburr inside and outside of the tube end (max 0,2 x 45°). The assembly area of the tube has to be free of contamination, chips and paint.

Please note: Improperly prepared and contaminated tubes will affect the service life of the connection and may result in leakage.

#### 2. Preparation and Machine-Assisted Tube Flaring

With regards to assembly preparation as well as the actual tube flaring process, please follow the detailed instructions in the operating manual of the machine.



## Assembly Instructions for STAUFF Connect 37° Flared Tube Fittings

### Tube Flaring with a STAUFF Press Machine and Assembly with the Fitting Body

#### 3. Inspection

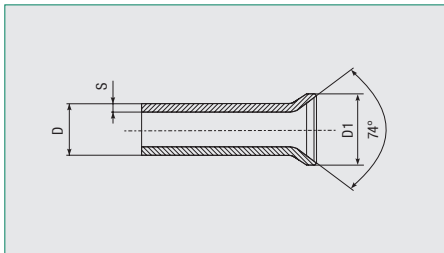

Check the flared tube end for cracking and impurities after flaring.

Always verify the dimensional accuracy of the flare.

The checking diameter corresponds to the outside diameter D1 of the flared tube end (according to dimension table on the right). The flare must be at right angle to the tube axis and concentric with the tube.

Please note: If the flare is eccentric, too short or not wide enough, perfect function of the tube fitting cannot be guaranteed!

#### 4. Assembly with the Fitting Body

Lubricate the o-rings of the 24°/37° flared tube adaptor (e.g. using mineral-oil based hydraulic fluid HLP32) and carefully insert it into the 24° taper of the fitting body.

It is recommended to use a bench vice to press and permanently capture the 24°/37° flared tube adaptor into the 24° taper of the tube fitting – a great help to the tube fitter during re-assembly. In this case, please make sure that all components are suitably protected against damage.

Apply the flared tube end to the 24°/37° flared tube adaptor, which is attached to the fitting body, tighten the union nut until the noticeable increase in force, and then finish the assembly with another approximately 1/2 a turn (180°) beyond this point.

Important: Always use a spanner to hold the fitting body during the assembly procedure.

Tube OD		Dimensions		D1 <sub>min</sub>		D1 <sub>max</sub>																																																																																																																																																																																																			
D	(in)	S	(in)	(mm)	(in)	(mm)	(in)																																																																																																																																																																																																		
6	.24	1	.04	9,1	.36	10	.39																																																																																																																																																																																																		
		1,5	.06					8	.31	1	.04	11,3	.44	12	.47	1,5	.06	2	.08	10	.39	1	.04	13,1	.52	14	.55	1,5	.06	2	.08	12	.47	1	.04	15,3	.60	16	.63	1,5	.06	2	.08	14	.55	1,5	.06	18,6	.73	19,6	.77	2	.08	2,5	.10	3	.12	15	.59	1,5	.06	19,1	.75	20	.79	2	.08	2,5	.10	16	.63	1,5	.06	20,6	.81	22	.87	2	.08	2,5	.10	3	.12	18	.71	1,5	.06	23,2	.91	24	.94	2	.08	2,5	.10	20	.79	2	.08	25,6	1.01	26,8	1.06	2,5	.10	3	.12	3,5	.14	22	.87	1,5	.06	26,5	1.04	27,5	1.08	2	.08	2,5	.10	3	.12	25	.98	2	.08	31,1	1.22	33	1.30	2,5	.10	3	.12	4	.16	28	1.10	2	.08	32,7	1.29	33,3	1.31	2,5	.10	3	.12	30	1.18	2	.08	37	1.46	38,7	1.52	2,5	.10	3	.12	4	.16	5	.20	35	1.38	2	.08	41,8	1.65	42,7	1.68	2,5	.10	3	.12	4	.16	38	1.50	2,5	.10	46	1.81	47,2	1.86	3	.12	4	.16	5	.20	2	.08	42	1.65	2	.08	48,8	1.92
8	.31	1	.04	11,3	.44	12	.47																																																																																																																																																																																																		
		1,5	.06																																																																																																																																																																																																						
		2	.08																																																																																																																																																																																																						
10	.39	1	.04	13,1	.52	14	.55																																																																																																																																																																																																		
		1,5	.06																																																																																																																																																																																																						
		2	.08																																																																																																																																																																																																						
12	.47	1	.04	15,3	.60	16	.63																																																																																																																																																																																																		
		1,5	.06																																																																																																																																																																																																						
		2	.08																																																																																																																																																																																																						
14	.55	1,5	.06	18,6	.73	19,6	.77																																																																																																																																																																																																		
		2	.08																																																																																																																																																																																																						
		2,5	.10																																																																																																																																																																																																						
		3	.12																																																																																																																																																																																																						
15	.59	1,5	.06	19,1	.75	20	.79																																																																																																																																																																																																		
		2	.08																																																																																																																																																																																																						
		2,5	.10																																																																																																																																																																																																						
16	.63	1,5	.06	20,6	.81	22	.87																																																																																																																																																																																																		
		2	.08																																																																																																																																																																																																						
		2,5	.10																																																																																																																																																																																																						
		3	.12																																																																																																																																																																																																						
18	.71	1,5	.06	23,2	.91	24	.94																																																																																																																																																																																																		
		2	.08																																																																																																																																																																																																						
		2,5	.10																																																																																																																																																																																																						
20	.79	2	.08	25,6	1.01	26,8	1.06																																																																																																																																																																																																		
		2,5	.10																																																																																																																																																																																																						
		3	.12																																																																																																																																																																																																						
		3,5	.14																																																																																																																																																																																																						
22	.87	1,5	.06	26,5	1.04	27,5	1.08																																																																																																																																																																																																		
		2	.08																																																																																																																																																																																																						
		2,5	.10																																																																																																																																																																																																						
		3	.12																																																																																																																																																																																																						
25	.98	2	.08	31,1	1.22	33	1.30																																																																																																																																																																																																		
		2,5	.10																																																																																																																																																																																																						
		3	.12																																																																																																																																																																																																						
		4	.16																																																																																																																																																																																																						
28	1.10	2	.08	32,7	1.29	33,3	1.31																																																																																																																																																																																																		
		2,5	.10																																																																																																																																																																																																						
		3	.12																																																																																																																																																																																																						
30	1.18	2	.08	37	1.46	38,7	1.52																																																																																																																																																																																																		
		2,5	.10																																																																																																																																																																																																						
		3	.12																																																																																																																																																																																																						
		4	.16																																																																																																																																																																																																						
		5	.20																																																																																																																																																																																																						
35	1.38	2	.08	41,8	1.65	42,7	1.68																																																																																																																																																																																																		
		2,5	.10																																																																																																																																																																																																						
		3	.12																																																																																																																																																																																																						
		4	.16																																																																																																																																																																																																						
38	1.50	2,5	.10	46	1.81	47,2	1.86																																																																																																																																																																																																		
		3	.12																																																																																																																																																																																																						
		4	.16																																																																																																																																																																																																						
		5	.20																																																																																																																																																																																																						
		2	.08																																																																																																																																																																																																						
42	1.65	2	.08	48,8	1.92	49,8	1.96																																																																																																																																																																																																		
		3	.12																																																																																																																																																																																																						
		4	.16																																																																																																																																																																																																						

#### 5. Repeated Assembly

For repeated assembly, the union nut has to be tightened using exactly the same force as for the original assembly.



## Assembly Instructions for STAUFF Connect 37° Flared Tube Fittings

### Tube Flaring with a STAUFF Press Machine and Assembly with the Fitting Body

#### Calculation Dimensions

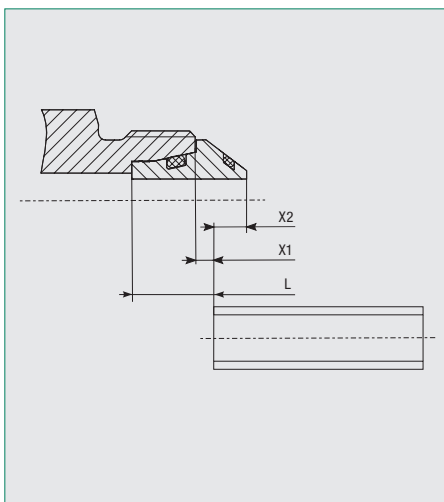

The correct tube length can be determined by measuring the distance between the 24°/37° flared tube adaptors pressed into the fitting bodies. Dimension X2 has then to be added for each of the connections.

The correct tube length can also be determined by measuring the distance between the fitting bodies. Dimension X1 has then to be subtracted for each of the connections.

Dimension L corresponds to the difference in tube length compared to cutting ring fittings. When changing over from cutting ring fittings to flared tube fittings, the tube has to be shortened by dimension L.

Tube OD		Dimensions					
D (mm)	(in)	X1		X2		L	
		(mm)	(in)	(mm)	(in)	(mm)	(in)
6	.24	1	.04	3,5	.14	8	.31
		2	.08	2,5	.10	9	.35
8	.31	1	.04	4	.16	8	.31
		2	.08	3	.12	9	.35
		2,5	.10	2,5	.10	9,5	.37
10	.39	1	.04	4,5	.18	8	.31
		2	.08	3,5	.14	9	.35
		3	.12	2,5	.10	10	.39
12	.47	1	.04	4,5	.18	8	.31
		2	.08	3,5	.14	9	.35
		3	.12	2,5	.10	10	.39
14	.55	0,5	.02	5,5	.22	8,5	.33
		1	.04	5	.20	9	.35
		2	.08	4	.16	10	.39
		3	.12	3	.12	11	.43
15	.59	1	.04	4,5	.18	8	.31
		2	.08	3,5	.14	9	.35
		3	.12	2,5	.10	10	.39
16	.63	0	.00	6,5	.26	8,5	.33
		1	.04	5,5	.22	9,5	.37
		1,5	.06	5	.20	10	.39
		2,5	.10	4	.16	11	.43
18	.71	0	.00	5,5	.22	7,5	.30
		1	.04	4,5	.18	8,5	.33
		1,5	.06	4	.16	9	.35
20	.79	1	.04	7	.28	11,5	.45
		2	.08	6	.24	12,5	.49
		3	.12	5	.20	13,5	.53
		4	.16	4	.16	14,5	.57
22	.87	1	.04	5,7	.22	8,5	.33
		2	.08	4,7	.19	9,5	.37
		3	.12	3,7	.15	10,5	.41
		3,5	.14	3,2	.13	11	.43
25	.98	1	.04	7	.28	13	.51
		1,5	.06	6,5	.26	13,5	.53
		2,5	.10	5,5	.22	14,5	.57
		4	.16	4	.16	16	.63
28	1.10	1,5	.06	5,7	.22	9	.35
		2,5	.10	4,7	.19	10	.39
		3	.12	4,2	.17	10,5	.41
30	1.18	-0,5	-.02	9	.35	13	.51
		0,5	.02	8	.31	14	.55
		1	.04	7,5	.30	14,5	.57
		3	.12	5,5	.22	16,5	.65
		4,5	.18	4	.16	18	.71
35	1.38	1,5	.06	6,5	.26	12	.47
		2	.08	6	.24	12,5	.49
		3	.12	5	.20	13,5	.53
		4,5	.18	3,5	.14	15	.59
38	1.50	0	.00	10	.39	16	.63
		0,5	.02	9,5	.37	16,5	.65
		2	.08	8	.31	18	.71
		4	.16	6	.24	20	.79
42	1.65	1,5	.06	7	.28	12,5	.49
		3	.12	6,5	.26	14	.55
		4,5	.18	5	.20	15,5	.61





## Assembly Instructions for STAUFF Connect 37° Flared Tube Fittings

### Tube Flaring with a STAUFF Press Machine and Assembly with the Fitting Body

#### Calculation Dimensions

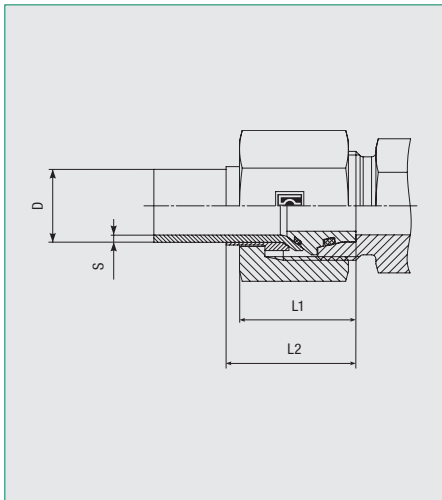

Series	Tube OD x Wall Thickness (mm/in) D x S	Dimensions (mm/in)		Corrected Tube Lengths for Different Wall Thicknesses (mm/in)														
		L1	L2	1	1,5	2	2,5	3	3,5	4	5							
L	6 x 1	17,5	20,5	•	1	1												
	.24 x .04	.69	.81		.04	.04												
	8 x 1	18,5	21,5	•	1	1,5												
	.31 x .04	.73	.85		.04	.06												
	10 x 1,5	19,5	24	-1	•	1												
	.39 x .06	.77	.94	-.04		.04												
	12 x 1,5	20	24,5	-1	•	1												
	.47 x .06	.79	.96	-.04		.04												
	15 x 1,5	21,5	25,5		•	1	2											
	.59 x .06	.85	1.00			.04	.08											
	18 x 2	23	27		-1	•	1											
	.71 x .08	.91	1.06		-.04		.04											
	22 x 2	24	30,5		-1	•	1	1,5										
	.87 x .08	.94	1.20		-.04		.04	.06										
	28 x 3	26	31,5				-1,5	-0,5	•									
	1.10 x .12	1.02	1.24				-.06	-.02										
	35 x 3	30	36				-1,5	-1	•								1,5	
	1.38 x .12	1.18	1.42				-.06	-.04									.06	
42 x 3	34	40				-1,5		•								1,5		
1.65 x .12	1.34	1.57				-.06										.06		
S	6 x 1	17,5	20,5	•	1	1												
	.24 x .04	.69	.81		.04	.04												
	8 x 1	18,5	21,5	•	1	1,5												
	.31 x .04	.73	.85		.04	.06												
	10 x 1,5	20	24,5	-1	•	1												
	.39 x .06	.79	.96	-.04		.04												
	12 x 1,5	20,5	25	-1	•	1												
	.47 x .06	.81	.98	-.04		.04												
	14 x 2	23	27,5		-0,5	•	1	2										
	.55 x .08	.91	1.08		-.02		.04	.08										
	16 x 2	25	31		-1	•	0,5	1,5										
	.63 x .08	.98	1.22		-.04		.02	.06										
	20 x 2	27,5	33			•	1	2										
	.79 x .08	1.08	1.30				.04	.08	.12									
	25 x 3	32	38,5				-1,5	-1	•								1,5	
	.98 x .12	1.26	1.52				-.06	-.04									.06	
	30 x 3	33	41,5				-2	-1	•								2	3,5
	1.18 x .12	1.30	1.63				-.08	-.04									.08	.14
38 x 3	37,5	48					-0,5	•								1,5	3,5	
1.50 x .12	1.48	1.89					-.02									.06	.14	



## Assembly Instructions for 24° Weld Cones with O-Ring

### 1. Tube Preparation

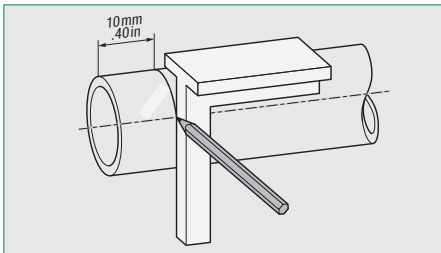

Saw off tube in right angle and at least 10 mm / .40 in from the cut made by the tube manufacturer / supplier in order to avoid failures caused during shipment.

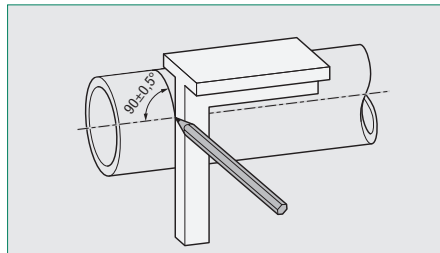

A maximum angular deviation / tolerance of  $\pm 0,5^\circ$  relative to the tube axis is permissible.

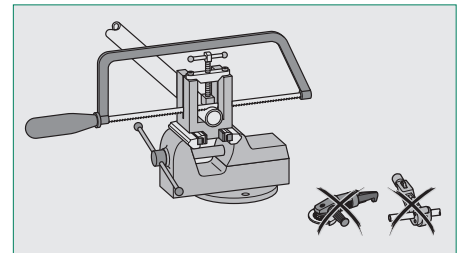

Only use proper tube sawing machinery or equipment. Do not use tube cutters or grinders as this may result in unwanted angled cuts and cause severe burring.

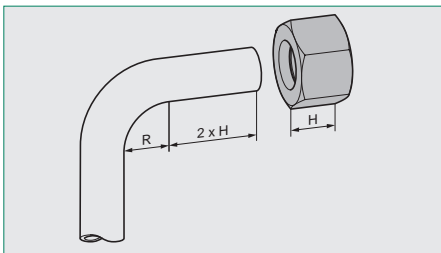

For tube bends, the length of the straight section of the tube end to the start of the bending radius has to be twice the height of the union nut.

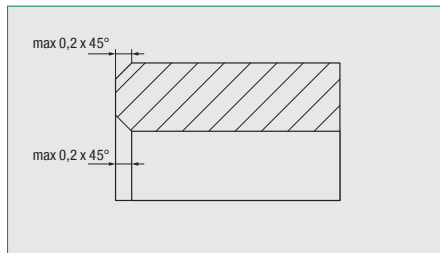

Slightly deburr inside and outside of the tube end (max 0,2 x 45°). The assembly area of the tube has to be free of contamination, chips and paint.



Please note: Improperly prepared and contaminated tubes will affect the service life of the connection and may result in leakage.

### 2. Assembly Preparation and Welding

Place the union nut on the weld cone.

The user is fully responsible for the quality of the welding work.

Lubricate the o-ring of the weld cone (e.g. using mineral-oil based hydraulic fluid HLP32). Do not use lubricating grease!

Remove the o-ring from the front end of the weld cone before welding (usually supplied separately).

Descal the welded area and clean the o-ring groove.

Immediately proceed with the assembly in order to avoid exposure to contamination.

Weld the weld cone and the tube end according to any applicable guidelines for welding.

Assemble the o-ring and make sure that it is located in the groove of the weld cone without being twisted.

### 3. Assembly with the Fitting Body

Carefully insert the weld cone into the 24° taper of the fitting body.

Tighten the union nut until the noticeable increase in force.

A marking line applied on the union nut and the fitting body makes it easier to indicate the sufficient tightening turns.

Then finish the assembly with another approximately 1/3 a turn (120°) beyond this point.

S

### 4. Repeated Assembly

For repeated assembly, the union nut has to be tightened using exactly the same force as for the original assembly.

The o-ring has to be checked for possible damages and, if necessary, replaced prior to the re-assembly.



## Assembly Instructions for 24° Weld Cones with O-Ring

## Calculation Dimensions

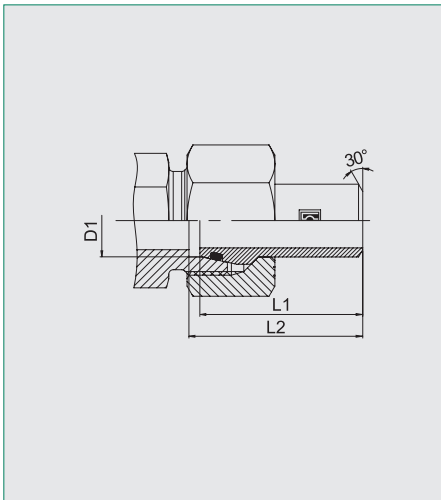

Series	Tube OD		Dimensions				
	D1 (mm)	(in)	L1 (mm)	(in)	L2 (mm)	(in)	
<b>L</b>	6	.24	31	1.22	32	1.26	
	8	.31	31	1.22	32	1.26	
	10	.39	32,5	1.28	33,5	1.32	
	12	.47	32,5	1.28	33,5	1.32	
	15	.59	35	1.38	36	1.42	
	18	.71	36	1.42	37	1.46	
	22	.87	38,5	1.52	39,5	1.56	
	28	1.10	41,5	1.63	42,5	1.67	
	35	1.38	47	1.85	49,5	1.95	
	42	1.65	47	1.85	50	1.97	
	<b>S</b>	6	.24	31	1.22	32	1.26
		8	.31	31	1.22	32	1.26
10		.39	32,5	1.28	33,5	1.32	
12		.47	32,5	1.28	33,5	1.32	
14		.55	38,5	1.52	39,5	1.56	
16		.63	39	1.54	41	1.61	
20		.79	44,5	1.75	47	1.85	
25		.98	49,5	1.95	53,5	2.11	
30		1.18	52,5	2.07	57,5	2.26	
38		1.50	56,5	2.22	64,5	2.54	



## Assembly Instructions for Tube Fittings with 24° Taper and O-Ring

### 1. Assembly Preparation

Make sure that the o-ring is located in the groove of the taper without being twisted.

Lubricate the o-ring of the taper fitting (e.g. using mineral-oil based hydraulic fluid HLP32). Do not use lubricating grease!

Immediately proceed with the assembly in order to avoid exposure to contamination.

### 2. Assembly with the Fitting Body

Keep the taper fitting aligned and carefully insert it into the 24° taper of the fitting body.

Tighten the wire-pin nut until the noticeable increase in force, and then finish the assembly with another approximately 1/3 a turn (120°) beyond this point.

Important: Always use a spanner to hold the fitting body during the assembly procedure.

A marking line applied on the nut and the fitting body makes it easier to indicate the sufficient tightening turns.

## Assembly Instructions for Tube Fittings with Standpipe

### 1. Assembly Preparation

Standpipe fittings are always supplied with factory-assembled cutting rings and union nuts.

### 2. Assembly with the Fitting Body

Keep the fitting with standpipe aligned and carefully insert it into the 24° taper of the fitting body.

Tighten the union nut until the noticeable increase in force, and then finish the assembly with another approximately 1/12 a turn (30°) beyond this point.

Important: Always use a spanner to hold the fitting body during the assembly procedure.

A marking line applied on the nut and the fitting body makes it easier to indicate the sufficient tightening turns.



## Assembly Instructions for Tube Fittings with Male Threaded Stud Whitworth Parallel Pipe Thread

### Tightening Torques

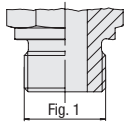
**Metallic Sealing Edge**

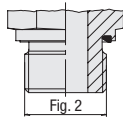
 Whitworth Parallel Pipe Thread  
 DIN 3852-2 (Form B) / ISO 1179-4 (Type B)

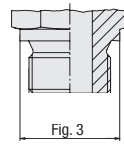
**Profile Sealing Ring**

 Whitworth Parallel Pipe Thread  
 ISO 1179-2 (Type E)

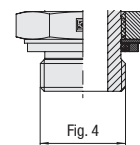
**Sealing Surface for Gaskets**

Whitworth Parallel Pipe Thread

**O-Ring with Retaining Ring  
(Adjustable)**

Whitworth Parallel Pipe Thread

Series	Thread	Male Threaded Studs			Check Valves	Adjustable Male Threaded Studs	Blanking Screws		fig. 2 Profile Sealing Ring Torque (N-m) ca.
		fig. 1 Metallic Sealing Edge Torque (N-m) ca.	fig. 2 Profile Sealing Ring Torque (N-m) ca.	fig. 3 Sealing Surface for Gaskets Torque (N-m) ca.	fig. 2 Profile Sealing Ring Torque (N-m) ca.	fig. 4 O-Ring with Retaining Ring Torque (N-m) ca.	fig. 2 Profile Sealing Ring Torque (N-m) ca.	fig. 1 Metallic Sealing Edge Torque (N-m) ca.	
L	G 1/8	25	18	20	18	25	18	25	15
		18.5	13.32	14.8	13.3	18.5	13.3	18.5	11.1
	G 1/4	55	35	50	35	50	33	40	25
		40.5	25.8	36.9	25.9	37.0	24.4	29.6	18.5
	G 3/8	95	70	80	70	80	70	95	50
		70.1	51.8	59.0	51.8	59.2	51.8	70.3	37.0
	G 1/2	185	90	140	90	105	90	130	70
		136.4	66.6	103.3	66.6	77.7	66.6	96.2	51.8
	G 3/4	250	180	190	180	220	180	250	120
		184.4	133.2	140.1	133.2	162.8	133.2	185.0	88.8
G 1	400	310	330	310	370	250	400	200	
	295	229.4	243.4	229.4	273.8	185.0	296.0	148.0	
G 1 1/4	670	450	540	450	500	400	600	320	
	494.2	333	398.3	333.0	370.0	296.0	444.0	236.8	
G 1 1/2	800	540	630	540	600	500	800	400	
	590	399.6	464.7	399.6	444.0	370.0	592.0	296.0	
S	G 1/8	30	25				18	25	15
		22.1	18.4				13.3	18.5	11.1
	G 1/4	80	55	60	55	50	33	40	25
		59.0	40.7	44.3	40.7	37.0	24.4	29.6	18.5
	G 3/8	130	80	100	80	80	70	95	50
		95.9	59.0	73.8	59.2	59.2	51.8	70.3	37.0
	G 1/2	220	115	160	115	105	90	130	70
		162.3	84.8	118.0	85.1	77.7	66.6	96.2	51.8
	G 3/4	350	180	280	180	220	181	250	120
		258.1	133.2	206.5	133.2	162.8	133.2	185.0	88.8
	G 1	700	310	440	310	370	250	400	200
		516.3	229.4	324.5	229.4	273.8	185.0	296.0	148.0
	G 1 1/4	850	450	580	450	500	400	600	320
		627	333	427.8	333.0	370.0	296.0	444.0	236.8
	G 1 1/2	1000	540	700	540	600	500	800	400
		737.6	399.6	516.3	399.6	444.0	370.0	592.0	296.0
G 2	1200								
	885.1								

Please note: The tightening torques for male threaded studs listed in this catalogue are approximate values with a tolerance of +10% and always refer to original components of the STAUFF Connect range made of steel with the default Zinc/Nickel coating and a steel mating material.

**Please contact STAUFF prior to the assembly for recommended tightening torques for use with any mating materials other than Steel!**



## Assembly Instructions for Tube Fittings with Male Threaded Stud Metric Parallel Thread

### Tightening Torques

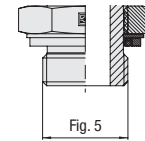
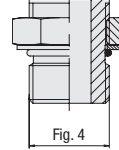
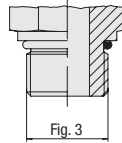
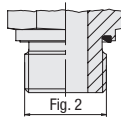
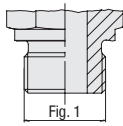

**Metallic Sealing Edge**

**Profile Sealing Ring**

**O-Ring**

**O-Ring without Retaining Ring (Adjustable)**

**O-Ring with Retaining Ring (Adjustable)**

Metric Parallel Thread  
DIN 3852-1 (Form B) /  
ISO 9974-3 (Type B)

Metric Parallel Thread  
ISO 9974-2 (Type E)

Metric Parallel Thread  
ISO 6149-2 /-3

Metric Parallel Thread  
ISO 6149-2 /-3

Metric Parallel Thread

Series	Thread	Male Threaded Studs			Check Valves	Adjustable Male Threaded Studs		Blanking Screws		
		fig. 1 Metallic Sealing Edge Torque (N-m) ca.	fig. 2 Profile Sealing Ring Torque (N-m) ca.	fig. 3 O-Ring Torque (N-m) ca.	fig. 2 Profile Sealing Ring Torque (N-m) ca.	fig. 5 O-Ring with Retaining Ring Torque (N-m) ca.	fig. 4 O-Ring Torque (N-m) ca.	fig. 2 Profile Sealing Ring Torque (N-m) ca.	fig. 2 Profile Sealing Ring Torque (N-m) ca.	fig. 3 O-Ring Torque (N-m) ca.
L	M 8 x 1	14							10	
		10.3							7.4	
	M 10 x 1	25	18	15	18	18	15	12	12	15
		18.4	13.32	11.1	13.3	13.3	11.1	8.9	8.9	11.1
	M 12 x 1,5	45	25	25	25	35	25	25	23	22
		33.3	18.5	18.5	18.4	25.9	18.5	18.5	17.0	16.3
	M 14 x 1,5	70	45	35	45	55	35	45	30	45
		51.6	33.3	25.9	33.3	40.7	25.9	33.3	22.2	33.3
	M 16 x 1,5	90	55	40	55	80	40	55	50	55
		66.4	40.7	29.6	40.7	59.2	29.6	40.7	37.0	40.7
	M 18 x 1,5	120	70	45	70	105	45	70	65	70
		88.5	51.8	33.3	51.8	77.7	33.3	51.8	48.1	51.8
	M 22 x 1,5	170	125	60	125	125	60	125	90	100
		125.4	92.5	44.4	92.5	92.5	44.4	92.5	66.6	74.0
M 26 x 1,5 <sup>2</sup>	230	180		180			180	100	170	
	169.6	133.2		132.8			133.2	74.0	125.8	
M 27 x 2		180	100		200	100	180	130	180	
		132.8	74.0		147.5	74.0	132.8	96.2	132.8	
M 33 x 2	400	310	160	310	370	160	250	250	215	
	295.0	229.4	118.4	229.4	273.8	118.4	185.0	185.0	159.1	
M 42 x 2	700	450	210	450	500	210	400	310	330	
	516.3	333	155.4	333	370.0	155.4	296.0	229.4	244.2	
M 48 x 2	900	540	260	540	600	260	500	380	420	
	663.8	399.6	192.4	399.6	44.0	192.4	370.0	281.2	310.8	
S	M 12 x 1,5	60	35	35	35	35	35	25	23	22
		44.3	25.8	25.8	25.9	25.9	25.9	18.5	17.0	16.3
	M 14 x 1,5	80	55	40	55	55	45	45	30	45
		59.0	40.6	29.6	40.7	40.7	33.3	33.3	22.2	33.3
	M 16 x 1,5	130	70	55	70	80	55	55	50	55
		95.9	51.6	40.7	51.8	59.2	40.7	40.7	37.0	40.7
	M 18 x 1,5	190	90	70	90	105	70	70	65	70
		140.1	66.4	51.6	66.4	77.7	51.8	51.8	48.1	51.8
	M 20 x 1,5	220	125		125			80	80	
		162.3	92.2		92.5			59.2	59.2	
	M 22 x 1,5	300	135	100	135	125	100	125	90	100
		221.3	99.6	74	99.6	92.5	74.0	92.5	66.6	74.0
	M 26 x 1,5		180					180	100	170
			132.8					132.8	74.0	125.8
	M 27 x 2	420	180	170	180	220	170	180	130	180
		309.8	132.8	125.8	132.8	162.8	125.8	132.8	96.2	132.8
	M 33 x 2	600	310	310	310	370	310	250	250	215
		442.5	229.4	229.4	229.4	273.8	229.4	185.0	185.0	159.1
M 42 x 2	700	450	330	450	500	330	400	310	330	
	516.3	333	244.2	333	370.0	244.2	296.0	229.4	244.2	
M 48 x 2	950	540	420	540	600	420	500	380	420	
	700.1	399.6	310.8	399.6	444.0	310.8	370.0	281.2	310.8	

<sup>2</sup>M 27 x 2 according to ISO 6149.

Please note: The tightening torques for male threaded studs listed in this catalogue are approximate values with a tolerance of +10% and always refer to original components of the STAUFF Connect range made of steel with the default Zinc/Nickel coating and a steel mating material.

Please contact STAUFF prior to the assembly for recommended tightening torques for use with any mating materials other than Steel!



## Assembly Instructions for Tube Fittings with Male Threaded Stud UN/UNF-Thread

### Tightening Torques

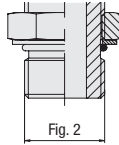
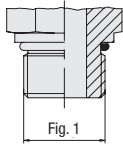

**O-Ring without Retaining Ring  
(Non-Adjustable)**

**O-Ring without Retaining  
Ring (Adjustable)**

UN/UNF-Thread

UN/UNF-Thread  
ISO 11926-2/-3

Series	Thread	Male Threaded Studs		Adjustable Male Threaded Studs	
		fig. 1 O-Ring	Torque (N-m) ca.	fig. 2 O-Ring	Torque (N-m) ca.
L	7/16-20 UNF	18	18		
		13.3	13.3		
	1/2-20 UNF	28			
		20.7			
	9/16-18 UNF	30	34		
		22.2	25.1		
	3/4-16 UNF	50	55		
		37.0	40.7		
	7/8-14 UNF	60	80		
		44.2	59		
1 1/16-12 UN	95	100			
	70.3	73.7			
1 5/16-12 UN	150	150			
	111.0	111.0			
1 5/8-12 UN	200	290			
	148.0	213.9			
1 7/8-12 UN	325	325			
	239.7	239.7			
S	7/16-20 UNF	20	20		
		14.8	14.8		
	9/16-18 UNF	35	46		
		25.9	33.9		
	3/4-16 UNF	70	80		
		51.8	59		
	7/8-14 UNF	100	80		
		74.0	59		
	1 1/16-12 UN	170	185		
		125.8	136.4		
1 5/16-12 UN	270				
	199.1				
1 5/8-12 UN	285	340			
	210.9	250.7			
1 7/8-12 UN	415	415			
	306.1	306.1			

Please note: The tightening torques for male threaded studs listed in this catalogue are approximate values with a tolerance of +10% and always refer to original components of the STAUFF Connect range made of steel with the default Zinc/Nickel coating and a steel mating material.

**Please contact STAUFF prior to the assembly for recommended tightening torques for use with any mating materials other than Steel!**

**S**



## Assembly Instructions for Banjo Fittings

### 1. Assembly Preparation

Lubricate the o-ring of the banjo bolt (e.g. using mineral-oil based hydraulic fluid HLP32). Do not use lubricating grease!

Immediately proceed with the assembly in order to avoid exposure to contamination.

### 2. Assembly with the Fitting Body

Place the external metallic sealing ring or the retaining ring with captive seal on the opposite side of the banjo fitting into the larger bore and center it through the thread for the banjo bolt. Retaining rings with captive seal are additionally centered through the bore in the fitting body – any clearance between the ring and the fitting body is not allowed.

Align the body of the banjo fitting and tighten the banjo bolt with a spanner until the noticeable increase in force (pressure point).

Use a suitable spanner to finish the assembly with either another approximately 1/6 a turn (60°, applicable for retaining rings with captive seal) or 1/4 a turn (90°, applicable for external metallic sealing rings) beyond this point while holding the body of the banjo fitting in position using a second spanner.

### Positioning and Orientation of Retaining Rings with Captive Seal

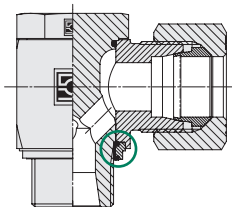

Applicable for RSWND / RSW / RST

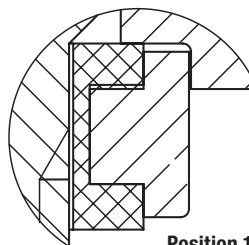

Position 1

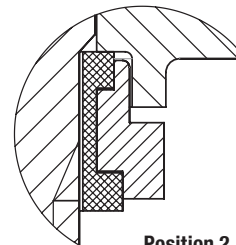

Position 2

Series	Tube OD (mm/in)	Thread	Position
L	6	G 1/8	2
	.24		
	8	G 1/4	2
	10	G 1/4	2
	12	G 3/8	1
	15	G 1/2	1
	18	G 1/2	1
	22	G 3/4	1
.87			
28	G 1	1	
			1.10
35	G 1 1/4	1	
			1.38
42	G 1 1/2	1	
			1.65
S	6	G 1/4	2
	.24		
	8	G 1/4	2
	10	G 3/8	1
	12	G 3/8	1
	14	G 1/2	1
	16	G 1/2	1
	20	G 3/4	1
.79			
25	G 1	1	
			.98
30	G 1 1/4	1	
			1.18
38	G 1 1/2	1	
			1.50

Series	Tube OD (mm/in)	Thread	Position
L	6	M 10x1	2
	.24		
	8	M 12x1,5	1
	10	M 14x1,5	2
	12	M 16x1,5	1
	15	M 18x1,5	1
	18	M 22x1,5	1
	22	M 26x1,5	1
.87			
28	M 33x2	1	
			1.10
35	M 42x2	1	
			1.38
42	M 48x2	1	
			1.65
S	6	M 12x1,5	1
	.24		
	8	M 14x1,5	2
	10	M 16x1,5	1
	12	M 18x1,5	1
	14	M 20x1,5	1
	16	M 22x1,5	1
	20	M 27x2	1
.79			
25	M 33x2	1	
			.98
30	M 42x2	1	
			1.18
38	M 48x2	1	
			1.50

S



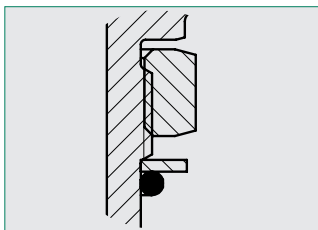
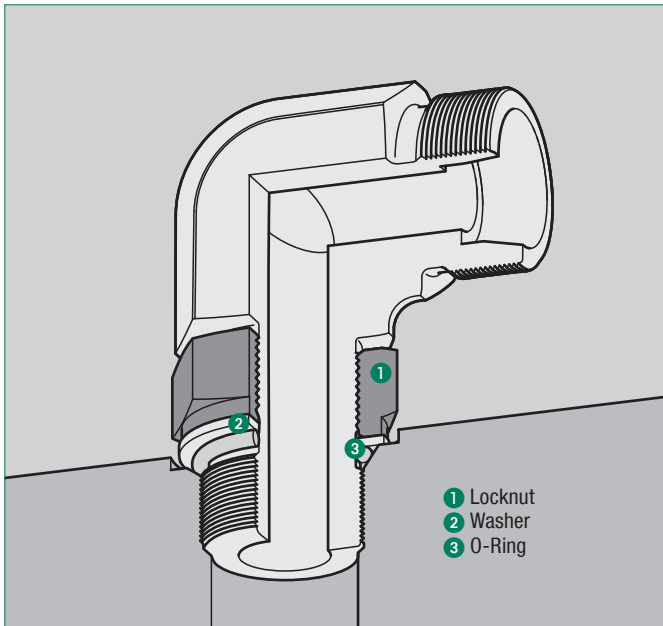
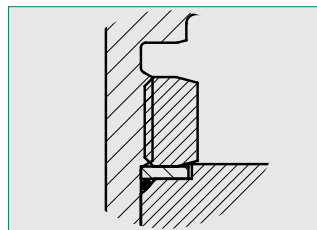
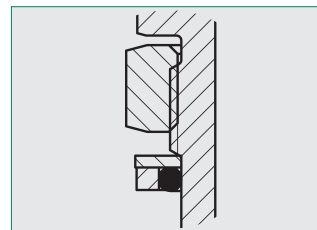
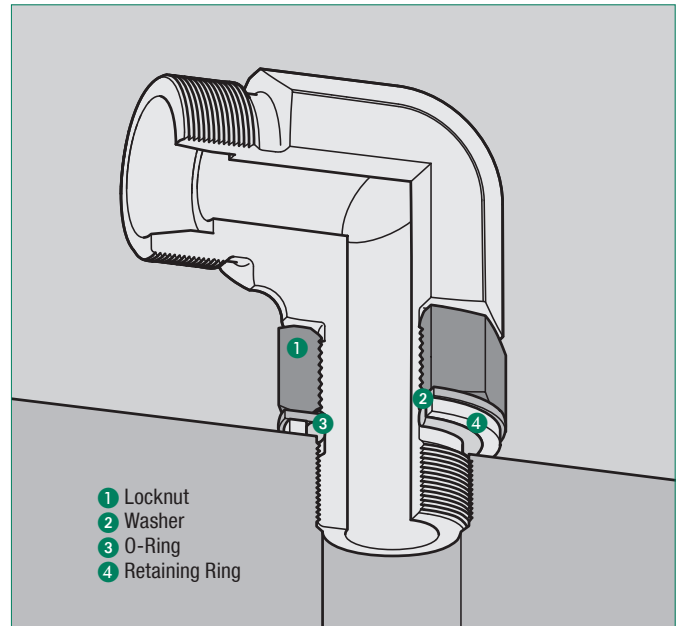
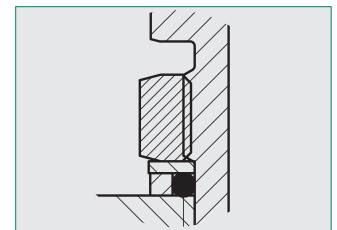
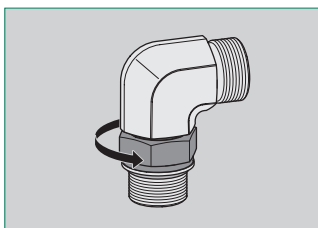

**Assembly Instructions for Adjustable Fitting with Locknut (WEE, VEE, TEE, LEE)**
**For use in Ports to ISO 6149 and SAE UNO**

**Pre-assembly**

**Post-assembly**
**For use in Ports Form X acc. to DIN 3852-2, ISO 1179-1**

**Pre-assembly**

**Post-assembly**
**1. Assembly Preparation**

Lubricate the o-ring (e.g. using mineral-oil based hydraulic fluid HLP32).  
Do not use lubricating grease!

Immediately proceed with the assembly in order to avoid exposure to contamination.

Ensure that the Locknut, O-Ring and Washer are fully raised.

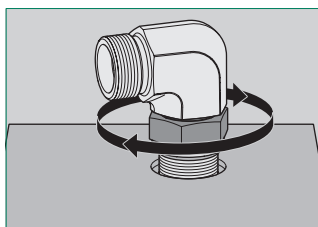

Please Note:  
For use in Ports Form X, ensure that the Retaining Ring is placed.

**2. Assembly**

Fully screw in the fitting body.

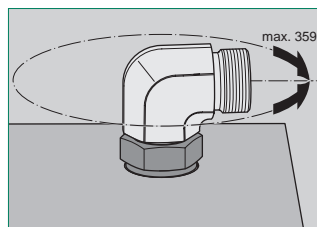

Adjust the direction.  
Caution: Turn back by no more than one rotation against the direction in which the fitting body was installed!

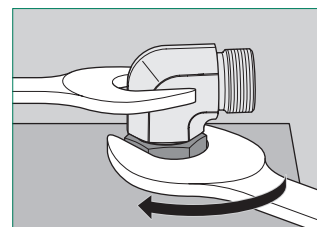

Tighten the locknut with the defined torque (see p. 171-179) while using a spanner to counter the fitting body in the direction of adjustment.

**S**



Tube Fitting Materials and Surface Finishings	324
Elastomer Seal Materials	325
Overview of media resistance	325
Pressure and Temperature Ratings	326
Pressure Reduction Factors	327
Calculated Design / Burst Pressures for Tube (bar)	328
Calculated Design / Burst Pressures for Tube (PSI)	330
Port Dimensions for Fittings with Male Threaded Stud	332
Dimensions of the 24° Conical Bore / Union Nut	336
Standard Threads and Widths Across Flats for Fittings with Male Threaded Stud	337
Certificates and Approvals	338



## Tube Fitting Materials and Surface Finishings

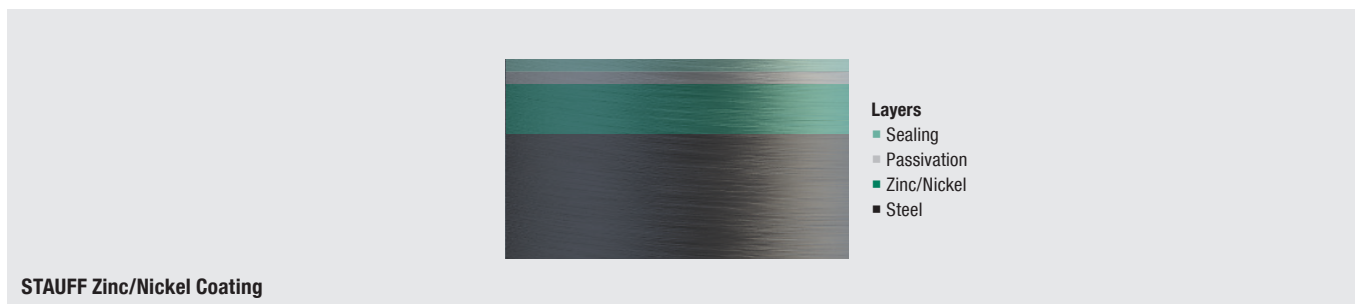

Fitting bodies of the STAUFF Connect range are usually machined from drawn or forged steel in accordance with DIN 3859-1 (Technical Specification for Tube Fittings).

Union nuts are either cold-pressed or hot-pressed.

Unless otherwise stated, all metal parts of the STAUFF Connect range of tube fittings are made of Steel with standard Zinc/Nickel coating (material code: W3), that offers excellent surface protection far beyond the market standard.

One of the few exceptions, weld fittings are made of Steel, phosphated (material code: W2).

Alternative surface coatings are available upon request.

Do not hesitate to contact STAUFF for further information.

### Main Advantages of the STAUFF Zinc/Nickel Coating

- Premium long-life surface protection against corrosion with more than 1200 hours resistance to red rust / base metal corrosion in the salt-spray test according to DIN EN ISO 9227
- Free of hexavalent chrome Cr(VI)
- ELV compliant according to 2000/53/EC (End of Life Vehicles Directive)
- REACH compliant according to 1907/2006/EC (Registration, Evaluation, Authorisation and Restriction of Chemicals)
- RoHS compliant according to 2002/95/EC (Restrictions of the Use of Hazardous Substances)
- Easily surpassing the requirements of the corrosion protection class K5 (360 hours resistance to white rust / 720 hours resistance to red rust) as defined by the VDMA, the German Engineering Association (VDMA Standard Sheet 24576 „Fluid Power - Requirements and designations for corrosion-protection coatings free of hexavalent chrome“)
- Significantly reduced tendency to corrosion by contact with other metals such as Aluminium and Stainless Steel
- High abrasion resistance due to the ductility / plastic deformability of the coating
- Appealing colour scheme with a bright semi-gloss surface finish – comparable to Stainless Steel
- Surface is paintable with good paint adhesion properties (However, a painting test and, if necessary, degreasing of the surfaces to be painted are highly recommended)
- Little to no risk of triggering allergies, as the Zinc/Nickel base layer with a nickel content of 12-15 % is covered by both a passivation and a sealing layer to avoid the release of nickel and any direct physical contact
- Resistant against all commonly used hydraulic media



## Elastomer Seal Materials

Unless otherwise stated, standard elastomer seals are made of NBR (Perbunan®).

Elastomer seals made of NBR (Perbunan® – material code: B) are especially suitable for liquid or gaseous media at operating temperatures that range from **-35 °C to +100 °C / -31 °F to +212 °F**.

Elastomer seals for applications with higher temperatures or aggressive media, such as FKM (Viton® – material code: V – operating temperature range from **-25 °C to +200 °C / -13 °F to +392 °F** and EPDM (material code: E), are available upon request.

Do not hesitate to contact STAUFF for further information.

The performance of elastomer seals during operation can be negatively affected by various influences. Elastomer seals should be inspected for any kind of damage (cracks, deformation, hardening or softening, swelling, reduced elasticity etc.) or contamination prior to the assembly process and when carrying out service and maintenance work, and should be replaced, if necessary.

Spare seals are available as part of the STAUFF Connect range.

Thanks to their zinc/nickel surface coating, STAUFF Connect Tube Connectors made of steel have a high resistance to all common hydraulics fluids, which also applies to contact with other media and aggressive substances.

However, STAUFF still recommends verifying the suitability of media which are not designated as common hydraulics fluids or to contact STAUFF before use if in doubt.

## Storage Recommendations

Please observe the following storage recommendations for elastomer seals in accordance with DIN 7716 (Requirements for Storage, Cleaning and Maintenance of Rubber Products):

- Store seals in a dry place, away from draughts, at temperatures not exceeding +25 °C / +77 °F.
- Protect seals from sunlight, ozone and strong artificial lightning during storage.

These recommendations do not only apply for separate elastomer seals, but also for tube fittings with pre-assembled o-rings and seals.

Not following these storage recommendations can cause brittle fracture of elastomer seals and result in leakage!

*Perbunan® is a registered trademark of Lanxess Deutschland GmbH.  
Viton® is a registered trademark of DuPont Performance Elastomers L.L.C.*

## Overview of media resistance

In addition to the resistance of the STAUFF zinc/nickel surface coatings, compatibility of the elastomers and other hydraulic components also have to be considered.

The following table shows a general overview of this. This is only intended for guidance!

Medium	STAUFF Connect fitting Steel	Sealing material NBR (Buna-N®)	FKM (Viton®)	EPDM
Acetone				
ASTM - oil no. 1				
ASTM - oil no. 2				
ASTM - oil no. 3				
ASTM - oil no. 4				
Petrol				
Benzene				
Brake fluid				
Diesel fuel				
Compressed air (dry, oil-free)				
Natural gas				
Oil/petroleum				
Ethanol (ethyl alcohol)				
Ether				
Liquid gas LPG (propane/butane)				
Gear oil				
Glycol (ethylene glycol)				
Heating oil				
Hydraulic fluids, biodegradable HEES (synthetic esters)	*	*		
Hydraulic fluids, biodegradable HEPG (polyglycol-based)			*	
Hydraulic fluids, flame-resistant HFC (water-glycol)				
Hydraulic oils HL/HLP (mineral oil-based)				
Carbon dioxide				
Carbon monoxide				
Seawater				
Methane				
Methanol (methyl alcohol)				
Mineral oils				
Natural gas, untreated (sour gas)				
Petroleum				
Crude oil				
Soap solution				
Silicone oils				
Skydrol 500				
Skydrol 7000				
Turpentine				
Water (up to 70°)				
Water vapour				

resistant
  limited resistance
  not resistant
 \* temperature-dependent

Note: The media resistance of the material always also depends on the temperature of the medium used.



## Pressure and Temperature Ratings

### General Information

Unless otherwise stated, all pressure ratings in this product catalogue are indicated in bar and PSI. All temperature ratings are indicated in °C (degree Celsius) and °F (degree Fahrenheit).

Pressure ratings are usually rounded to correspond with standardised pressure ratings, which are internationally recognised and assist to identify and match common sizes of components together.

All tube fittings and other components of the STAUFF Connect range meet or exceed common standardised pressure ratings for mobile and industrial fluid power applications up to nominal pressures of 800 bar / 11600 PSI (depending on series, type and size of the component – pressure reduction factors to be considered).

Pressure ratings are divided into nominal pressures (PN) and permissible operating pressures (PB).

### Nominal Pressure (PN)

Nominal pressure (PN) is a term used to describe the pressure that tube fittings and other components are designed to safely withstand, and indicates the maximum operating pressure of tube fittings and other components that should be applied to the component when operating the system under stationary conditions.

During static load tests, burst pressures must be at least 4 times higher than the nominal pressures (safety factor of 4).

### Permissible Operating Pressure (PB)

The permissible operating pressure (PB) of a component (as defined in DIN 2401, part 1) is identical to the maximum internal overpressure at regular operating conditions (operating temperature of +120 °C without dynamic loads / pressure peaks) as calculated based on the material in use and considering the permissible operating temperature (TB).

During static load tests, burst pressures must be at least 2,5 times higher than the permissible operating pressures (safety factor of 2,5).

### Please note:

The pressure ratings and safety factors as specified are only applicable when strictly following the assembly instructions (e.g. tightening torques for male stud fittings) and only refer to original components of the STAUFF Connect range. Avoid mixing with other brands' products!

If components are exposed to vibrations, dynamic loads or pressure peaks, the pressure ratings must be reduced accordingly in order to keep the same level of safety.

### Permissible Operating Temperature (TB)

Unless otherwise stated, the permissible operating temperature (TB) for tube fittings and other components in this product catalogue ranges from -20 °C to +120 °C / -4 °F to +248 °F in accordance with DIN 3859-1 (Technical Specification for Tube Fittings).

Please observe that the permissible operating temperature may differ for tube fittings and other components that use elastomer seals. Deviations for tube fittings made of stainless steel see next page.



## Pressure Reduction Factors

Pressure reduction factors (in percent) have to be considered when intending to use the components at operating temperatures exceeding +120 °C / +248 °F for steel and +50 °C / +122 °F for stainless steel.

**Calculation Example**

Component                      Straight Fitting FI-G-10S-W3-MS made of Steel  
with a nominal pressure (PN) rating of 800 bar / 11600 PSI

Temperature                    +175 °C / +347 °F

Reduction Factor            15 %

$$PN = \frac{800 \text{ bar}}{100 \%} \times (100 \% - 15 \%) = 680 \text{ bar}$$

Reduced Nominal Pressure

$$PN = \frac{11600 \text{ PSI}}{100 \%} \times (100 \% - 15 \%) = 9860 \text{ PSI}$$

**Please note:**

When selecting tubes and other components for your system, any additional potential pressure reduction factors stated by the manufacturers / suppliers have to be considered.

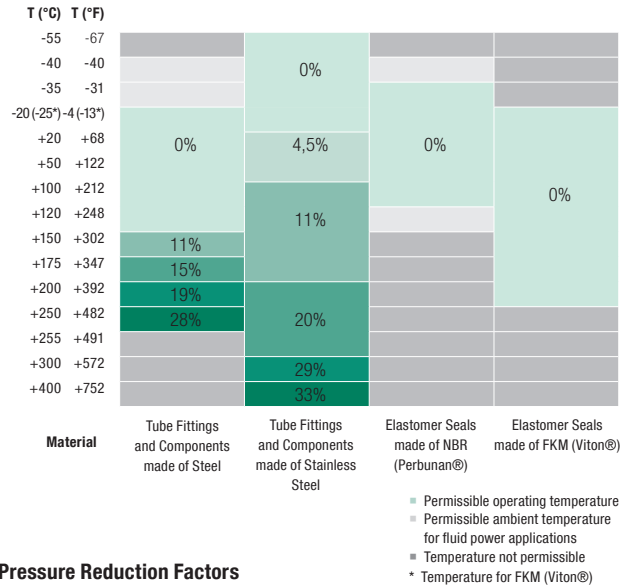

## Selection Criteria for Tube

STAUFF recommends to use seamless, cold-drawn and normalized precision steel tubes as specified in DIN EN 10305-4, material E235+N (material number 1.0308+N, formerly St37.4) or material E355 (material number 1.0580, formerly St52.4).

In order to avoid misdeliveries, the tubes have to be ordered from the supplier by specifying the exact outer and inner diameter.

Tube materials and tolerances differing from these recommendations may lead to system faults or leakages and may even result in total breakdowns.

Unless otherwise stated, the pressure / temperature ratings as well as all other operating conditions indicated in this product catalogue do not refer to the actual tube. Specifications made by the respective tube manufacturers / suppliers have to be considered.



### Calculated Design / Burst Pressures for Tube (bar)

Tube OD (mm)	Tube ID (mm)	Tube Wall (mm)	STAUFF Nominal pressure (bar)		Calculated Design Pressure (bar) in accordance with DIN 2413 - Load Case I (predominantly static loads, up to +120 °C)			Calculated Design Pressure (bar) in accordance with DIN 2413 - Load Case III (dynamic / pulsating loads, up to +120 °C)			Calculated Burst Pressure (bar) in accordance with ISO 10763		
			Light Series	Heavy Series	Material E235+N	Material E355	Material 1.4571	Material E235+N	Material E355	Material 1.4571	Material E235+N	Material E355	Material 1.4571
6	4,5	0,75	500	800	338	491	368	303	310	256	1116	1525	1346
6	4	1	500	800	450	655	490	391	400	330	1573	2149	1898
6	3	1,5	500	800	675	983	735	551	563	465	2689	3674	3244
6*	2	2	500	800	900	1310	980	692	708	585	4263	5823	5142
6*	1,5	2,25	500	800	1013	1474	1103	757	774	639	5379	7347	6488
8	6	1	500	800	338	491	368	303	310	256	1116	1525	1346
8	5	1,5	500	800	506	737	551	433	443	366	1824	2491	2200
8	4	2	500	800	675	983	735	551	563	465	2689	3674	3244
8*	3	2,5	500	800	844	1228	919	659	673	556	3806	5198	4590
10	8	1	500	800	270	393	294	248	253	209	866	1183	1044
10	7	1,5	500	800	405	590	441	357	365	301	1384	1890	1669
10	6	2	500	800	540	786	588	458	468	386	1982	2707	2391
10	5	2,5	500	800	675	983	735	551	563	465	2689	3674	3244
10*	4	3	500	800	810	1179	882	638	652	539	3555	4856	4288
12	10	1	400	630	225	328	245	209	214	177	707	966	853
12	9	1,5	400	630	338	491	368	303	310	256	1116	1525	1346
12	8	2	400	630	450	655	490	391	400	330	1573	2149	1898
12	7	2,5	400	630	563	819	613	474	484	400	2091	2857	2523
12	6	3	400	630	675	983	735	551	563	465	2689	3674	3244
12*	5	3,5	400	630	823	1180	858	624	638	527	3397	4640	4097
12*	4	4	400	630	940	1348	980	692	708	585	4263	5823	5142
14	12	1		630	193	281	210	181	185	153	598	817	721
14	11	1,5		630	289	421	315	264	270	223	936	1278	1129
14	10	2		630	386	561	420	342	349	289	1306	1783	1575
14	9	2,5		630	482	702	525	415	425	351	1714	2342	2068
14	8	3		630	579	842	630	485	496	410	2171	2966	2619
14	7	3,5		630	705	1011	735	551	563	465	2689	3674	3244
15	13	1	400		180	262	196	170	174	143	555	758	670
15	12	1,5	400		270	393	294	248	253	209	866	1183	1044
15	11	2	400		360	524	392	321	329	271	1203	1644	1452
15	10	2,5	400		450	655	490	391	400	330	1573	2149	1898
15	9	3	400		540	786	588	458	468	386	1982	2707	2391
16	14	1		630	169	246	184	160	163	135	518	708	625
16	13	1,5		630	253	368	276	233	239	197	806	1100	972
16	12	2		630	338	491	368	303	310	256	1116	1525	1346
16	11	2,5		630	422	614	459	370	378	312	1454	1986	1754
16	10	3		630	506	737	551	433	443	366	1824	2491	2200
16	8	4		630	705	1011	735	551	563	465	2689	3674	3244
18	16	1	400		150	218	163	143	146	121	457	624	551
18	15	1,5	400		225	328	245	209	214	177	707	966	853
18	14	2	400		300	437	327	273	279	230	975	1332	1176
18	13	2,5	400		375	546	408	333	341	281	1263	1725	1523
18	12	3	400		450	655	490	391	400	330	1573	2149	1898
18	10	4	400		627	899	653	500	511	422	2281	3115	2751
20	17	1,5		420	203	295	221	190	194	160	631	861	761
20	16	2		420	270	393	294	248	253	209	866	1183	1044
20	15	2,5		420	338	491	368	303	310	256	1116	1525	1346
20	14	3		420	405	590	441	357	365	301	1384	1890	1669
20	13	3,5		420	494	708	515	408	417	345	1671	2283	2016
20	12	4		420	564	809	588	458	468	386	1982	2707	2391
20	10	5		420	705	1011	735	551	563	465	2689	3674	3244

Load case I according to DIN 2413 describes predominantly static loads at temperatures not exceeding +120 °C.  
 Load case III according to DIN 2413 describes dynamic / pulsating loads at temperatures not exceeding +120 °C.

For some sizes of thin-walled steel tube, support sleeves are highly recommended and in some case generally required.  
 Please see page G11 for selection charts and detailed assembly instructions.

T



## Calculated Design / Burst Pressures for Tube (bar)

Tube OD (mm)	Tube ID (mm)	Tube Wall (mm)	STAUFF Nominal pressure (bar)		Calculated Design Pressure (bar) in accordance with DIN 2413 - Load Case I (predominantly static loads, up to +120 °C)			Calculated Design Pressure (bar) in accordance with DIN 2413 - Load Case III (dynamic / pulsating loads, up to +120 °C)			Calculated Burst Pressure (bar) in accordance with ISO 10763		
			Light Series	Heavy Series	Material E235+N	Material E355	Material 1.4571	Material E235+N	Material E355	Material 1.4571	Material E235+N	Material E355	Material 1.4571
22	20	1	250		123	179	134	118	121	100	370	505	446
22	19	1,5	250		184	268	200	173	177	146	569	777	686
22	18	2	250		245	357	267	227	232	192	779	1064	939
22	17	2,5	250		307	447	334	278	285	235	1000	1366	1207
22	16	3	250		368	536	401	328	335	277	1236	1688	1490
22	15	3,5	250		449	643	468	376	384	317	1486	2030	1792
22	14	4	250		513	735	535	422	431	356	1754	2396	2115
25	22	1,5		420	162	236	176	154	157	130	496	678	598
25	21	2		420	216	314	235	201	206	170	676	924	816
25	20	2,5		420	270	393	294	248	253	209	866	1183	1044
25	19	3		420	324	472	353	292	299	247	1065	1455	1284
25	18	3,5		420	395	566	412	336	343	283	1275	1741	1537
25	17	4		420	451	647	470	378	386	319	1496	2044	1805
25	16	4,5		420	508	728	529	418	428	353	1732	2365	2089
25	15	5		420	564	809	588	458	468	386	1982	2707	2391
28	25	1,5	250		145	211	158	138	141	117	440	601	530
28	24	2	250		193	281	210	181	185	153	598	817	721
28	23	2,5	250		241	351	263	223	228	188	763	1043	921
28	22	3	250		289	421	315	264	270	223	936	1278	1129
28	21	3,5	250		353	506	368	303	310	256	1116	1525	1346
28	20	4	250		403	578	420	342	349	289	1306	1783	1575
30	26	2		420	180	262	196	170	174	143	555	758	670
30	25	2,5		420	225	328	245	209	214	177	707	966	853
30	24	3		420	270	393	294	248	253	209	866	1183	1044
30	23	3,5		420	329	472	343	285	291	241	1031	1408	1243
30	22	4		420	376	539	392	321	329	271	1203	1644	1452
30	20	5		420	470	674	490	391	400	330	1573	2149	1898
30	18	6		420	564	809	588	458	468	386	1982	2707	2391
35	32	1,5	250		121	173	126	111	114	94	348	475	419
35	31	2	250		161	231	168	147	150	124	471	643	568
35	30	2,5	250		201	289	210	181	185	153	598	817	721
35	29	3	250		242	347	252	215	220	181	730	997	880
35	27	4	250		322	462	336	280	286	236	1007	1375	1215
35	25	5	250		403	578	420	342	349	289	1306	1783	1575
38	34	2		420	148	213	155	136	139	115	432	589	521
38	33	2,5		420	186	266	193	168	171	142	547	748	660
38	32	3		420	223	319	232	199	203	168	667	911	804
38	30	4		420	297	426	309	260	265	219	917	1253	1106
38	28	5		420	371	532	387	318	325	268	1185	1619	1429
38	26	6		420	445	639	464	373	382	315	1472	2011	1776
38	24	7		420	519	745	542	427	436	360	1783	2436	2151
38	22	8		420	594	851	619	478	488	404	2121	2897	2558
42	39	1,5	250		101	144	105	93	96	79	288	393	347
42	38	2	250		134	193	140	123	126	104	388	530	468
42	37	2,5	250		168	241	175	153	156	129	492	672	593
42	36	3	250		201	289	210	181	185	153	598	817	721
42	34	4	250		269	385	280	237	242	200	820	1120	989
42	32	5	250		336	481	350	290	297	245	1041	1441	1273

All figures are based on calculations carried out in accordance with DIN 2413 and ISO 10763.

They are intended to assist the user in the pre-selection of the correct tube only, and do not discharge the obligation to carry out own calculations in consideration of the actual conditions of use.

DIN 2413 does not apply to tube sizes marked by \* (where D1/D2 > 2).

T



### Calculated Design / Burst Pressures for Tube (PSI)

Tube OD (in)	Tube ID (in)	Tube Wall (in)	STAUFF Nominal pressure (bar)	Calculated Design Pressure (PSI) in accordance with DIN 2413 - Load Case I (primary static loads, up to +248 °F)			Calculated Design Pressure (PSI) in accordance with DIN 2413 - Load Case III (dynamic loads, up to +248 °F)			Calculated Burst Pressure (PSI) in accordance with ISO 10763			
				Light Series	Heavy Series	Material E235+N	Material E355	Material 1.4571	Material E235+N	Material E355	Material 1.4571	Material E235+N	Material E355
D1	D2	S											
.24	.18	.03	7252	11603	4901	7120	5337	4394	4495	3713	16182	22113	19522
.24	.16	.04	7252	11603	6525	9498	7107	5670	5800	4786	22809	31161	27529
.24	.12	.06	7252	11603	9788	14254	10660	7990	8164	6744	38991	53273	47051
.24*	.08	.08	7252	11603	13050	18995	14214	10034	10266	8485	61814	84434	74580
.24*	.06	.09	7252	11603	14689	21373	15998	10977	11223	9268	77996	106532	94102
.31	.24	.04	7252	11603	4901	7120	5337	4394	4495	3713	16182	22113	19522
.31	.20	.06	7252	11603	7337	10687	7992	6279	6424	5308	26448	36120	31909
.31	.16	.08	7252	11603	9788	14254	10660	7990	8164	6744	38991	53273	47051
.31*	.12	.10	7252	11603	12238	17806	13329	9556	9759	8064	55187	75371	66573
.39	.31	.04	7252	11603	3915	5699	4264	3596	3669	3031	12557	17154	15142
.39	.28	.06	7252	11603	5873	8555	6396	5177	5293	4366	20068	27405	24207
.39	.24	.08	7252	11603	7830	11397	8528	6641	6786	5599	28739	39252	34679
.39	.20	.10	7252	11603	9788	14254	10660	7990	8164	6744	38991	53273	47051
.39*	.16	.12	7252	11603	11745	17096	12793	9251	9454	7818	51548	70412	62193
.47	.39	.04	5802	9138	3263	4756	3553	3031	3103	2567	10252	14007	12372
.47	.35	.06	5802	9138	4901	7120	5337	4394	4495	3713	16182	22113	19522
.47	.31	.08	5802	9138	6525	9498	7107	5670	5800	4786	22809	31161	27529
.47	.28	.10	5802	9138	8164	11876	8891	6873	7018	5802	30320	41427	36594
.47	.24	.12	5802	9138	9788	14254	10660	7990	8164	6744	38991	53273	47051
.47*	.20	.14	5802	9138	11934	17110	12444	9048	9251	7644	49257	67280	59423
.47*	.16	.16	5802	9138	13630	19546	14214	10034	10266	8485	61814	84434	74580
.55	.47	.04		9138	2799	4075	3046	2625	2683	2219	8671	11847	10457
.55	.43	.06		9138	4191	6105	4569	3828	3915	3234	13572	18531	16375
.55	.39	.08		9138	5597	8135	6092	4959	5061	4192	18937	25854	22844
.55	.35	.10		9138	6989	10179	7615	6018	6163	5091	24853	33959	29994
.55	.31	.12		9138	8396	12209	435	7033	7192	5947	31480	43007	37986
.55	.28	.14		9138	10223	14660	10660	7990	8164	6744	38991	53273	47051
.59	.51	.04	5802		2610	3799	2843	2465	2523	2074	8048	10991	9718
.59	.47	.06	5802		3915	5699	4264	3596	3669	3031	12557	17154	15142
.59	.43	.08	5802		5220	7598	5686	4655	4771	3931	17444	23838	21060
.59	.39	.10	5802		6525	9498	7107	5670	5800	4786	22809	31161	27529
.59	.35	.12	5802		7830	11397	8528	6641	6786	5599	28739	39252	34679
.63	.55	.04		9138	2451	3567	2669	2320	2364	1958	7511	10266	9065
.63	.51	.06		9138	3669	5336	4003	3379	3466	2857	11687	15950	14098
.63	.47	.08		9138	4901	7120	5337	4394	4495	3713	16182	22113	19522
.63	.43	.10		9138	6119	8903	6657	5365	5481	4525	21083	28797	25440
.63	.39	.12		9138	7337	10687	7992	6279	6424	5308	26448	36120	31909
.63	.31	.16		9138	10223	14660	10660	7990	8164	6744	38991	53273	47051
.71	.63	.04	5802		2175	3161	2364	2074	2117	1755	6627	9048	7992
.71	.59	.06	5802		3263	4756	3553	3031	3103	2567	10252	14007	12372
.71	.55	.08	5802		4350	6337	4743	3959	4046	3336	14138	19314	17057
.71	.51	.10	5802		5438	7917	5918	4829	4945	4076	18314	25013	22090
.71	.47	.12	5802		6525	9498	7107	5670	5800	4786	22809	31161	27529
.71	.39	.16	5802		9092	13036	9471	7250	7410	6121	33075	45168	39901
.79	.67	.06		6092	2944	4278	3205	2755	2813	2321	9150	12485	11038
.79	.63	.08		6092	3915	5699	4264	3596	3669	3031	12557	17154	15142
.79	.59	.10		6092	4901	7120	5337	4394	4495	3713	16182	22113	19522
.79	.55	.12		6092	5873	8555	6396	5177	5293	4366	20068	27405	24207
.79	.51	.14		6092	7163	10266	7470	5916	6047	5004	24230	33104	29240
.79	.47	.16		6092	8178	11731	8528	6641	6786	5599	28739	39252	34679
.79	.39	.20		6092	10223	14660	10660	7990	8164	6744	38991	53273	47051

Load case I according to DIN 2413 describes predominantly static loads at temperatures not exceeding +248 °F.  
 Load case III according to DIN 2413 describes dynamic / pulsating loads at temperatures not exceeding +248 °F.

For some sizes of thin-walled steel tube, support sleeves are highly recommended and in some case generally required.  
 Please see page G11 for selection charts and detailed assembly instructions.

T

## Calculated Design / Burst Pressures for Tube (PSI)

Tube OD (in)	Tube ID (in)	Tube Wall (in)	STAUFF Nominal pressure (bar)	Calculated Design Pressure (PSI) in accordance with DIN 2413 - Load Case I (primary static loads, up to +248 °F)			Calculated Design Pressure (PSI) in accordance with DIN 2413 - Load Case III (dynamic loads, up to +248 °F)			Calculated Burst Pressure (PSI) in accordance with ISO 10763			
				Light Series	Heavy Series	Material E235+N	Material E355	Material 1.4571	Material E235+N	Material E355	Material 1.4571	Material E235+N	Material E355
D1	D2	S											
.87	.79	.04	3626		1784	2596	1944	1711	1755	1450	5365	7323	6469
.87	.75	.06	3626		2668	3886	2901	2509	2567	2118	8251	11267	9950
.87	.71	.08	3626		3553	5177	3873	3292	3364	2785	11296	15428	13619
.87	.67	.10	3626		4452	6482	4844	4031	4133	3408	14500	19807	17506
.87	.63	.12	3626		5336	7772	5816	4756	4858	4018	17922	24476	21611
.87	.59	.14	3626		6511	9324	6788	5452	5568	4598	21547	29435	25991
.87	.55	.16	3626		7439	10658	7760	6119	6250	5163	25433	34742	30676
.98	.87	.06		6092	2349	3422	2553	2233	2277	1886	7192	9831	8673
.98	.83	.08		6092	3132	4553	3408	2915	2987	2466	9802	13398	11835
.98	.79	.10		6092	3915	5699	4264	3596	3669	3031	12557	17154	15142
.98	.75	.12		6092	4698	6844	5120	4234	4336	3582	15443	21098	18623
.98	.71	.14		6092	5728	8207	5976	4872	4974	4105	18488	25245	22293
.98	.67	.16		6092	6540	9382	6817	5481	5597	4627	21692	29638	26180
.98	.63	.18		6092	7366	10556	7673	6061	6206	5120	25114	34293	30299
.98	.59	.20		6092	8178	11731	8528	6641	6786	5599	28739	39252	34679
1.10	.98	.06	3626		2103	3060	2292	2001	2045	1697	6380	8715	7687
1.10	.94	.08	3626		2799	4075	3046	2625	2683	2219	8671	11847	10457
1.10	.91	.10	3626		3495	5090	3815	3234	3306	2727	11064	15124	13358
1.10	.87	.12	3626		4191	6105	4569	3828	3915	3234	13572	18531	16375
1.10	.83	.14	3626		5119	7337	5337	4394	4495	3713	16182	22113	19522
1.10	.79	.16	3626		5844	8381	6092	4959	5061	4192	18937	25854	22844
1.18	1.02	.08		6092	2610	3799	2843	2465	2523	2074	8048	10991	9718
1.18	.98	.10		6092	3263	4756	3553	3031	3103	2567	10252	14007	12372
1.18	.94	.12		6092	3915	5699	4264	3596	3669	3031	12557	17154	15142
1.18	.91	.14		6092	4771	6844	4975	4133	4220	3495	14950	20416	18028
1.18	.87	.16		6092	5452	7816	5686	4655	4771	3931	17444	23838	21060
1.18	.79	.20		6092	6815	9773	7107	5670	5800	4786	22809	31161	27529
1.18	.71	.24		6092	8178	11731	8528	6641	6786	5599	28739	39252	34679
1.38	1.26	.06	3626		1755	2509	1828	1610	1653	1363	5046	6888	6077
1.38	1.22	.08	3626		2335	3350	2437	2132	2175	1798	6830	9324	8238
1.38	1.18	.10	3626		2915	4191	3046	2625	2683	2219	8671	11847	10457
1.38	1.14	.12	3626		3509	5032	3655	3118	3190	2625	10585	14457	12764
1.38	1.06	.16	3626		4669	6699	4873	4060	4147	3423	14602	19938	17622
1.38	.98	.20	3626		5844	8381	6092	4959	5061	4192	18937	25854	22844
1.50	1.34	.08		6092	2146	3089	2248	1972	2016	1668	6264	8541	7557
1.50	1.30	.10		6092	2697	3857	2799	2436	2480	2060	7932	10846	9573
1.50	1.26	.12		6092	3234	4626	3365	2886	2944	2437	9672	13210	11661
1.50	1.18	.16		6092	4307	6177	4482	3770	3843	3176	13297	18169	16041
1.50	1.10	.20		6092	5380	7714	5613	4611	4713	3887	17183	23476	20726
1.50	1.02	.24		6092	6453	9266	6730	5409	5539	4569	21344	29160	25759
1.50	.94	.28		6092	7526	10803	7861	6192	6322	5221	25854	35322	31198
1.50	.87	.31		6092	8613	12340	8978	6931	7076	5860	30755	42007	37101
1.65	1.54	.06	3626		1465	2088	1523	1349	1392	1146	4176	5699	5033
1.65	1.50	.08	3626		1943	2799	2031	1784	1827	1508	5626	7685	6788
1.65	1.46	.10	3626		2436	3495	2538	2219	2262	1871	7134	9744	8601
1.65	1.42	.12	3626		2915	4191	3046	2625	2683	2219	8671	11847	10457
1.65	1.34	.16	3626		3901	5583	4061	3437	3509	2901	11890	16240	14344
1.65	1.26	.20	3626		4872	6975	5076	4205	4307	3553		20895	18464

All figures are based on calculations carried out in accordance with DIN 2413 and ISO 10763.

They are intended to assist the user in the pre-selection of the correct tube only, and do not discharge the obligation to carry out own calculations in consideration of the actual conditions of use.

DIN 2413 does not apply to tube sizes marked by \* (where D1/D2 > 2).

T



## Port Dimensions for Fittings with Male Threaded Stud

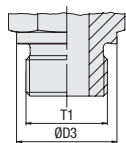

**Metallic Sealing Edge**

Metric Parallel Thread  
DIN 3852-1 (Form B) / ISO 9974-3 (Type B)  
Whitworth Parallel Pipe Thread  
DIN 3852-2 (Form B) / ISO 1179-4 (Type B)

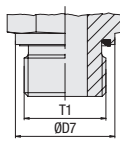

**Profile Sealing Ring**

Metric Parallel Thread  
ISO 9974-2 (Type E)  
Whitworth Parallel Pipe Thread  
ISO 1179-2 (Type E)

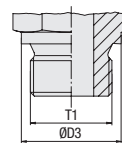

**Sealing Surface for Gasket (DIN 7603)**

Metric Parallel Thread  
DIN 3852-1 (Form A)  
Whitworth Parallel Pipe Thread  
DIN 3852-2 (Form A)

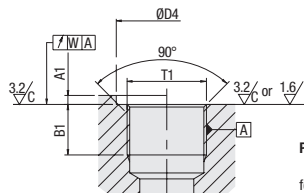

**Port (Parallel Thread)**

for Male Studs with Metric Parallel Thread  
DIN 3852-1 (Form X) / ISO 9974-1  
for Male Studs with Whitworth Parallel Pipe Thread  
DIN 3852-2 (Form X) / ISO 1179-1

**Dimensions**

Thread T1 <sup>1</sup>	D3	D7 <sub>-0.2</sub>	D4 small <sub>min</sub>	D4 wide <sub>min</sub>	A1 <sub>max</sub>	B1 <sub>min</sub>	W
M 8 x 1	12 .47		13 .51	17 .67	1 .04	8 .31	0,1 .0039
M 10 x 1	14 .55	13,9 .55	15 .59	20 .79	1 .04	8 .31	0,1 .0039
M 12 x 1,5	17 .67	16,9 .67	18 .71	25 .98	1,5 .06	12 .47	0,1 .0039
M 14 x 1,5	19 .75	18,9 .74	20 .79	25 .98	1,5 .06	12 .47	0,1 .0039
M 16 x 1,5	21 .83	21,9 .86	23 .91	28 1.10	1,5 .06	12 .47	0,1 .0039
M 18 x 1,5	23 .91	23,9 .94	25 .98	30 1.18	2 .08	12 .47	0,1 .0039
M 20 x 1,5	24 .94	25,9 1.02	27 1.06	34 1.34	2 .08	14 .55	0,1 .0039
M 22 x 1,5	27 1.06	26,9 1.06	28 1.10	34 1.34	2,5 .10	14 .55	0,1 .0039
M 26 x 1,5	31 1.22	31,9 1.26	33 1.30	42 1.65	2,5 .10	16 .63	0,2 .0079
M 27 x 2	32 1.26	31,9 1.26	33 1.30	42 1.65	2,5 .10	16 .63	0,2 .0079
M 33 x 2	39 1.54	39,9 1.57	41 1.61	47 1.85	2,5 .10	18 .71	0,2 .0079
M 42 x 2	49 1.93	49,9 1.96	51 2.01	58 2.28	2,5 .10	20 .79	0,2 .0079
M 48 x 2	55 2.17	54,9 2.16	56 2.20	65 2.56	2,5 .10	22 .87	0,2 .0079
G 1/8 A	14 .55	13,9 .55	15 .59	19 .75	1 .04	8,5 .33	0,1 .0039
G 1/4 A	18 .71	18,9 .74	20 .79	25 .98	1,5 .06	12,5 .49	0,1 .0039
G 3/8 A	22 .87	21,9 .86	23 .91	28 1.10	2 .08	12,5 .49	0,1 .0039
G 1/2 A	26 1.02	26,9 1.06	28 1.10	34 1.34	2,5 .10	15 .59	0,1 .0039
G 3/4 A	32 1.26	31,9 1.26	33 1.30	42 1.65	2,5 .10	16,5 .65	0,2 .0079
G 1 A	39 1.54	39,9 1.57	41 1.61	47 1.85	2,5 .10	19 .75	0,2 .0079
G 1 1/4 A	49 1.93	49,9 1.96	51 2.01	58 2.28	2,5 .10	21,1 .83	0,2 .0079
G 1 1/2 A	55 2.17	54,9 2.16	56 2.20	65 2.56	2,5 .10	22,5 .89	0,2 .0079

<sup>1</sup> Appendix A in the thread description does not apply to (female) threaded ports.

T

## Port Dimensions for Fittings with Male Threaded Stud

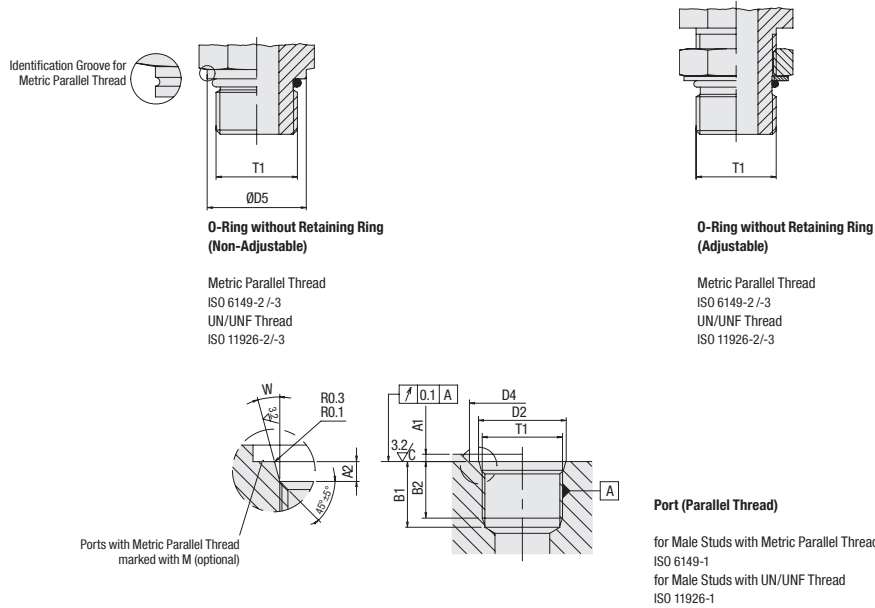

**Dimensions**

(mm/in)

Thread T1 <sup>1</sup>	D5	D4 small <sub>min</sub>	D4 wide <sub>min</sub>	D2 <sub>+0.1 (UN/UNF: ±0.05)</sub>	A1 <sub>max</sub>	A2 <sub>+0.4</sub>	B1 <sub>min</sub>	B2 <sub>min</sub>	W <sub>±1*</sub>
M 8 x 1	11,8 .46	14 .55	17 .67	9,1 .36	1 .04	1,6 .06	11,5 .45	10 .39	12 .47
M 10 x 1	13,8 .54	16 .63	20 .79	11,1 .44	1 .04	1,6 .06	11,5 .45	10 .39	12 .47
M 12 x 1,5	16,8 .66	19 .75	23 .91	13,8 .54	1,5 .06	2,4 .09	14 .55	11,5 .45	15 .59
M 14 x 1,5	18,8 .74	21 .83	25 .98	15,8 .62	1,5 .06	2,4 .09	14 .55	11,5 .45	15 .59
M 16 x 1,5	21,8 .86	24 .94	28 1.10	17,8 .70	1,5 .06	2,4 .09	15,5 .61	13 .51	15 .59
M 18 x 1,5	23,8 .94	26 1.02	30 1.18	19,8 .78	2 .08	2,4 .09	17 .67	14,5 .57	15 .59
M 22 x 1,5	26,8 1.06	29 1.14	33 1.30	23,8 .94	2 .08	2,4 .09	18 .71	15,5 .61	15 .59
M 27 x 2	31,8 1.25	34 1.34	40 1.57	29,4 1.16	2 .08	3,1 .12	22 .87	19 .75	15 .59
M 33 x 2	40,8 1.61	43 1.69	49 1.93	35,4 1.39	2,5 .10	3,1 .12	22 .87	19 .75	15 .59
M 42 x 2	49,8 1.96	52 2.05	58 2.28	44,4 1.75	2,5 .10	3,1 .12	22,5 .89	19,5 .77	15 .59
M 48 x 2	54,8 2.16	57 2.24	63 2.48	50,4 1.98	2,5 .10	3,1 .12	25 .98	22 .87	15 .59
7/16-20 UNF-2A	14,4 .57	21 .83		12,45 .49	1,6 .06	2,4 .09	14 .55	11,5 .45	12 .47
1/2-20 UNF-2A	16 .63	23 .91		14,05 .55	1,6 .06	2,4 .09	14 .55	11,5 .45	12 .47
9/16-18 UNF-2A	17,6 .69	25 .98		15,7 .62	1,6 .06	2,5 .10	15,5 .61	12,7 .50	12 .47
3/4-16 UNF-2A	21,8 .86	30 1.18		20,65 .81	2,4 .09	2,5 .10	17,5 .69	14,3 .56	15 .59
7/8-14 UNF-2A	25,5 1.00	34 1.34		24 .94	2,4 .09	2,5 .10	20 .79	16,7 .66	15 .59
1 1/16-12 UN-2A	31,9 1.26	41 1.61		29,2 1.15	2,4 .09	3,3 .13	23 .91	19 .75	15 .59
1 5/16-12 UN-2A	38,2 1.50	49 1.93		35,55 1.40	3,2 .13	3,3 .13	23 .91	19 .75	15 .59
1 5/8-12 UN-2A	47,7 1.88	58 2.28		43,55 1.71	3,2 .13	3,3 .13	23 .91	19 .75	15 .59
1 7/8-12 UN-2A	54,8 2.16	65 2.56		49,9 1.96	3,2 .13	3,3 .13	23 .91	19 .75	15 .59

<sup>1</sup> Appendix -2B instead of -2A applies for (female) threaded ports.

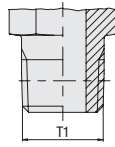
### Port Dimensions for Fittings with Male Threaded Stud



**Taper Thread**

National Pipe Thread (NPT)  
ANSI/ASME B1.20.1-1983

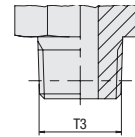

**Taper Thread**

Metric Taper Thread  
DIN 3852-1 (Form C)  
Whitworth Taper Pipe Thread  
DIN 3852-2 (Form C)

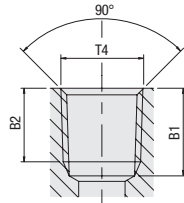

**Port (Taper Thread)**

for Male Studs with National Pipe NPT Thread  
ANSI/ASME B1.20.1-1983

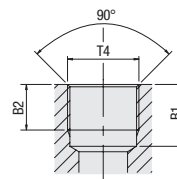

**Port (Parallel Thread)**

for Male Studs with Metric Taper Thread  
DIN 3852-1 (Form Z)  
for Male Studs with Whitworth Taper Pipe Thread  
DIN 3852-2 (Form Z)

**Dimensions**

(mm/in)

Thread T1	Thread T3	Thread T4	B1 <sub>min</sub>	B2 <sub>min</sub>
1/8-27 NPT		1/8-27 NPT		6,9 .27
1/4-18 NPT		1/4-18 NPT		10 .39
3/8-18 NPT		3/8-18 NPT		10,3 .41
1/2-14 NPT		1/2-14 NPT		13,6 .54
3/4-14 NPT		3/4-14 NPT		14,1 .56
1-11.5 NPT		1-11.5 NPT		16,8 .66
1 1/4-11.5 NPT		1 1/4-11.5 NPT		17,3 .68
1 1/2-11.5 NPT		1 1/2-11.5 NPT		17,3 .68
	M 8 x 1 keg.	M 8 x 1	10 .39	5,5 .22
	M 10 x 1 keg.	M 10 x 1	10 .39	5,5 .22
	M 12 x 1,5 keg.	M 12 x 1,5	13,5 .53	8,5 .33
	M 14 x 1,5 keg.	M 14 x 1,5	13,5 .53	8,5 .33
	M 16 x 1,5 keg.	M 16 x 1,5	13,5 .53	8,5 .33
	M 18 x 1,5 keg.	M 18 x 1,5	13,5 .53	8,5 .33
	M 20 x 1,5 keg.	M 20 x 1,5	15,5 .61	10,5 .41
	M 22 x 1,5 keg.	M 22 x 1,5	15,5 .61	10,5 .41
	R 1/8 keg.	Rp 1/8	8,5 .33	5,5 .22
	R 1/4 keg.	Rp 1/4	12,5 .49	8,5 .33
	R 3/8 keg.	Rp 3/8	12,5 .49	8,5 .33
	R 1/2 keg.	Rp 1/2	16,5 .65	10,5 .41

Suitable liquid / plastic sealant required to achieve leak-tightness.

T



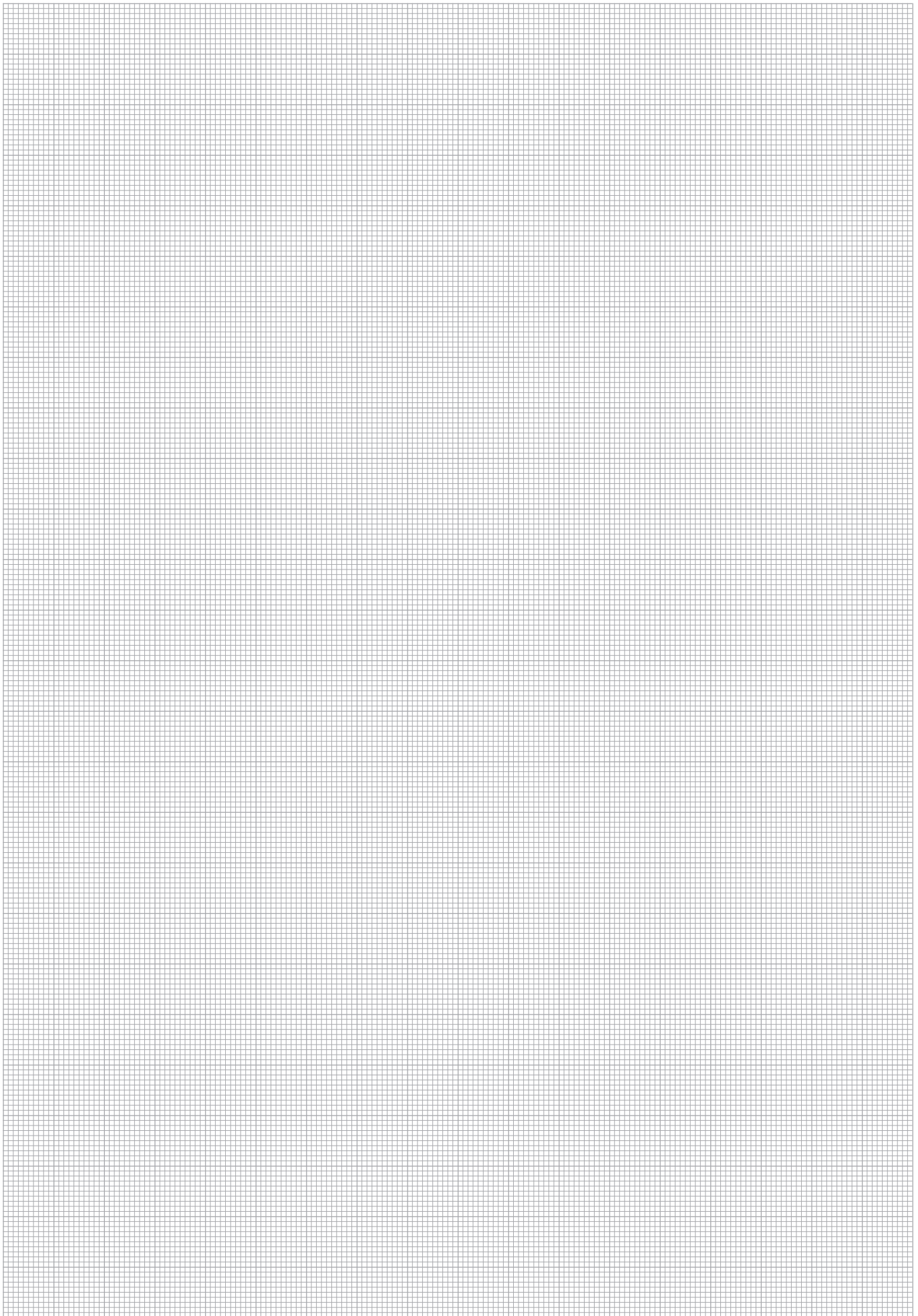

T



Dimensions of the 24° Conical Bore / Union Nut

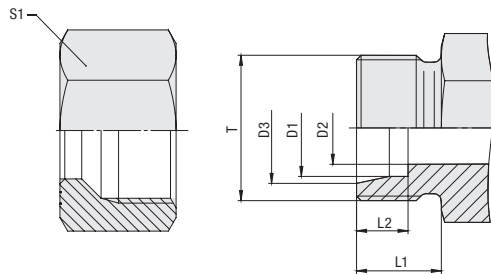

Series	Tube OD		Dimensions						
	(mm/in)	(mm/in)	Thread T	D2	D3	L1	L2	S1	
LL	4	.16	M 8 x 1	3	5	8	4	10	
	.12			.20	.31	.16	.39		
	6	.24	M 10 x 1	4,5	7,5	8	5,5	12	
	.18			.30	.31	.22	.47		
8	.31	M 12 x 1	6	9,5	9	5,5	14		
.24			.37	.35	.22	.55			
L	6	.24	M 12 x 1,5	4	8,1	10	7	14	
	.16			.32	.39	.28	.55		
	8	.31	M 14 x 1,5	6	10,1	10	7	17	
	.24			.40	.39	.28	.67		
	10	.39	M 16 x 1,5	8	12,3	11	7	19	
	.31			.48	.43	.28	.75		
	12	.47	M 18 x 1,5	10	14,3	11	7	22	
	.39			.56	.43	.28	.87		
	15	.59	M 22 x 1,5	12	17,3	12	7	27	
	.47			.68	.47	.28	1.06		
	18	.71	M 26 x 1,5	15	20,3	12	7,5	32	
	.59			.80	.47	.30	1.26		
	22	.87	M 30 x 2	19	24,3	14	7,5	36	
	.75			.96	.55	.30	1.42		
	28	1.10	M 36 x 2	24	30,3	14	7,5	41	
	.94			1.19	.55	.30	1.61		
35	1.38	M 45 x 2	30	38	16	10,5	50		
1.18			1.50	.63	.41	1.97			
42	1.65	M 52 x 2	36	45	16	11	60		
1.42			1.77	.63	.43	2.36			
S	6	.24	M 14 x 1,5	4	8,1	12	7	17	
	.16			.32	.47	.28	.67		
	8	.31	M 16 x 1,5	5	10,1	12	7	19	
	.20			.40	.47	.28	.75		
	10	.39	M 18 x 1,5	7	12,3	12	7,5	22	
	.28			.48	.47	.30	.87		
	12	.47	M 20 x 1,5	8	14,3	12	7,5	24	
	.31			.56	.47	.30	.94		
	14 <sup>1</sup>	.55 <sup>1</sup>	M 22 x 1,5	10	16,3	14	8	27	
	.39			.64	.55	.31	1.06		
	16	.63	M 24 x 1,5	12	18,3	14	8,5	30	
	.47			.72	.55	.33	1.18		
	20	.79	M 30 x 2	16	22,9	16	10,5	36	
	.63			.90	.63	.41	1.42		
	25	.98	M 36 x 2	20	27,9	18	12	46	
	.79			1.10	.71	.47	1.81		
30	1.18	M 42 x 2	25	33	20	13,5	50		
.98			1.30	.79	.53	1.97			
38	1.50	M 52 x 2	32	41	22	16	60		
1.26			1.61	.87	.63	2.36			

<sup>1</sup> Tube size is no longer covered by the applicable standard.





## Standard Threads and Widths Across Flats for Fittings with Male Threaded Stud

Series	Tube OD (mm) D1	Male Stud		Male Stud		Union Nut	
		Metric Parallel Thread Thread Size	Width Across Flats	Whitworth Parallel Pipe Thread Thread Size	Width Across Flats	Metric Parallel Thread Thread Size	Width Across Flats
L	6	M 10 x 1	14	G 1/8	14	M 12 x 1,5	14
	.24		.55		.55		.55
	8	M 12 x 1,5	17	G 1/4	19	M 14 x 1,5	17
	.31		.67		.75		.67
	10	M 14 x 1,5	19	G 1/4	19	M 16 x 1,5	19
	.39		.75		.75		.75
	12	M 16 x 1,5	22	G 3/8	22	M 18 x 1,5	22
	.47		.87		.87		.87
	15	M 18 x 1,5	24	G 1/2	27	M 22 x 1,5	27
	.59		.94		1.06		1.06
	18	M 22 x 1,5	27	G 1/2	27	M 26 x 1,5	32
	.71		1.06		1.06		1.26
	22	M 26 x 1,5 <sup>2</sup>	32	G 3/4	32	M 30 x 2	36
	.87		1.26		1.26		1.42
28	M 33 x 2	41	G 1	41	M 36 x 2	41	
1.10		1.61		1.61		1.61	
35	M 42 x 2	50	G 1 1/4	50	M 45 x 2	50	
1.38		1.97		1.97		1.97	
42	M 48 x 2	55	G 1 1/2	55	M 52 x 2	60	
1.65		2.17		2.17		2.36	
S	6	M 12 x 1,5	17	G 1/4	19	M 14 x 1,5	17
	.24		.67		.75		.67
	8	M 14 x 1,5	19	G 1/4	19	M 16 x 1,5	19
	.31		.75		.75		.75
	10	M 16 x 1,5	22	G 3/8	22	M 18 x 1,5	22
	.39		.87		.87		.87
	12	M 18 x 1,5	24	G 3/8	22	M 20 x 1,5	24
	.47		.94		.87		.94
	14 <sup>1</sup>	M 20 x 1,5	27	G 1/2	27	M 22 x 1,5	27
	.55 <sup>1</sup>		1.06		1.06		1.06
	16	M 22 x 1,5	27	G 1/2	27	M 24 x 1,5	30
	.63		1.06		1.06		1.18
	20	M 27 x 2	32	G 3/4	32	M 30 x 2	36
	.79		1.26		1.26		1.42
25	M 33 x 2	41	G 1	41	M 36 x 2	46	
.98		1.61		1.61		1.81	
30	M 42 x 2	50	G 1 1/4	50	M 42 x 2	50	
1.18		1.97		1.97		1.97	
38	M 48 x 2	55	G 1 1/2	55	M 52 x 2	60	
1.50		2.17		2.17		2.36	

<sup>1</sup> Tube size is no longer covered by the applicable standard.

<sup>2</sup> M 27 x 2 according to ISO 6149.

## Certificates and Approvals

Our in-house laboratories carry out constant checks and tests in line with international standards on all STAUFF products. Certified in accordance with ISO 9001, ISO 14001, OHSAS 18001 and ISO 50001, the STAUFF quality assurance system continually strives for perfection.

The QA system encompasses both product quality, which is driven by customer requirements, and all related services. The QA focuses on the expectations of all partners involved. Quality management at STAUFF is a dynamic process that is checked on a daily basis to ensure that continuous improvements are made.

### Please note:

All named approvals and certificates refer to certain products and designs, as well as to the application.

STAUFF is tuned in to the needs of the global market and this, together with the benefit of an experienced and highly motivated team of employees and the use of innovative technology, enables the company to offer a sophisticated product range which will satisfy the requirements of each and every customer worldwide.

The validity of the approvals will be continuously extended at the approval offices after expiry. Details, such as the period of validity, can be found in the respective certificates.

The most common STAUFF Connect Tube Fittings have received certifications and approvals from various international institutes, organisations and authorities who have independently confirmed the quality and performance of the products:

- Bureau Veritas
- DNV - GL
- DVGW
- Lloyd's Register

Please contact STAUFF for further approvals.

Please find a current version of the approvals and certificates at: [www.stauff.com/certificates](http://www.stauff.com/certificates)



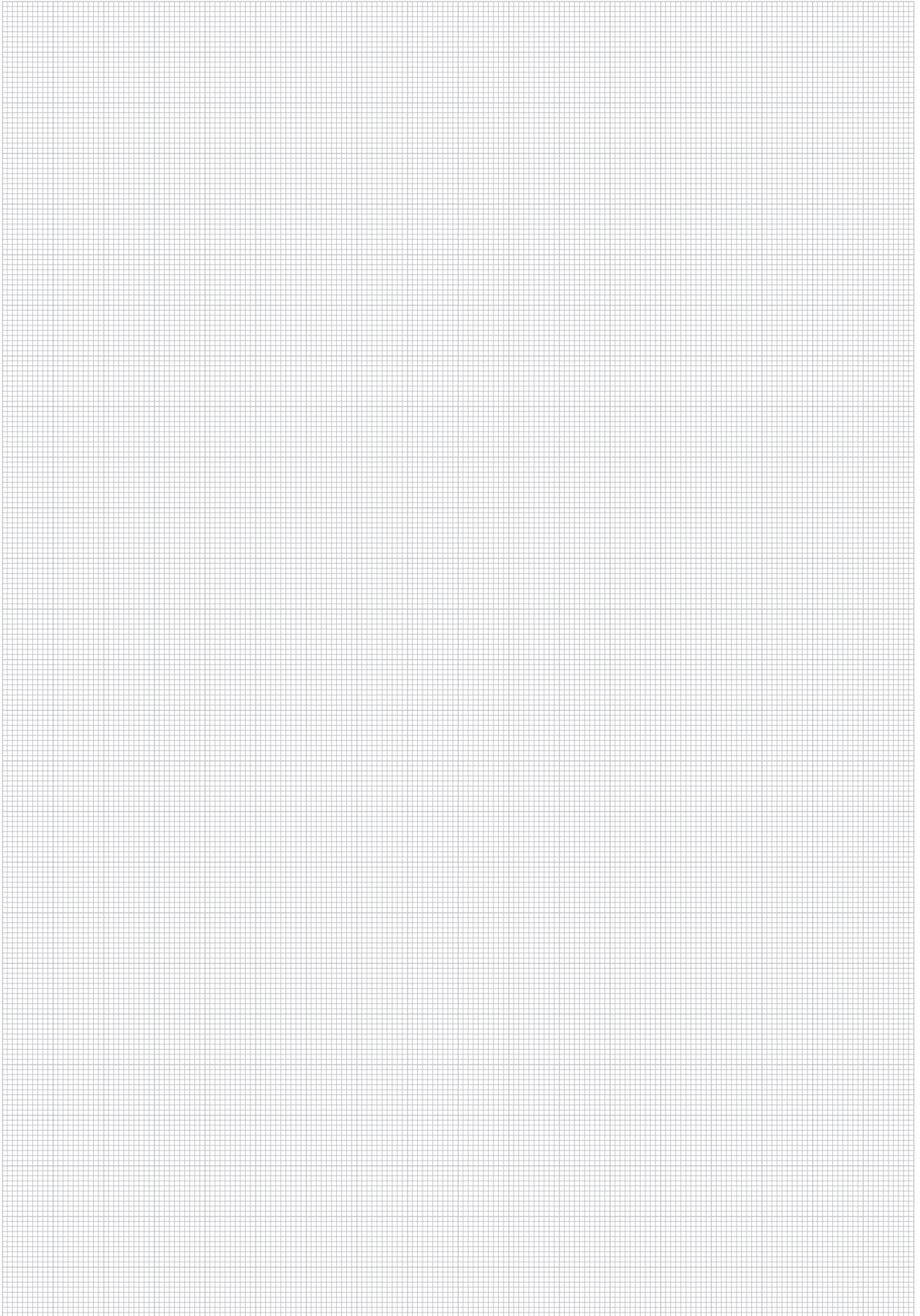

T



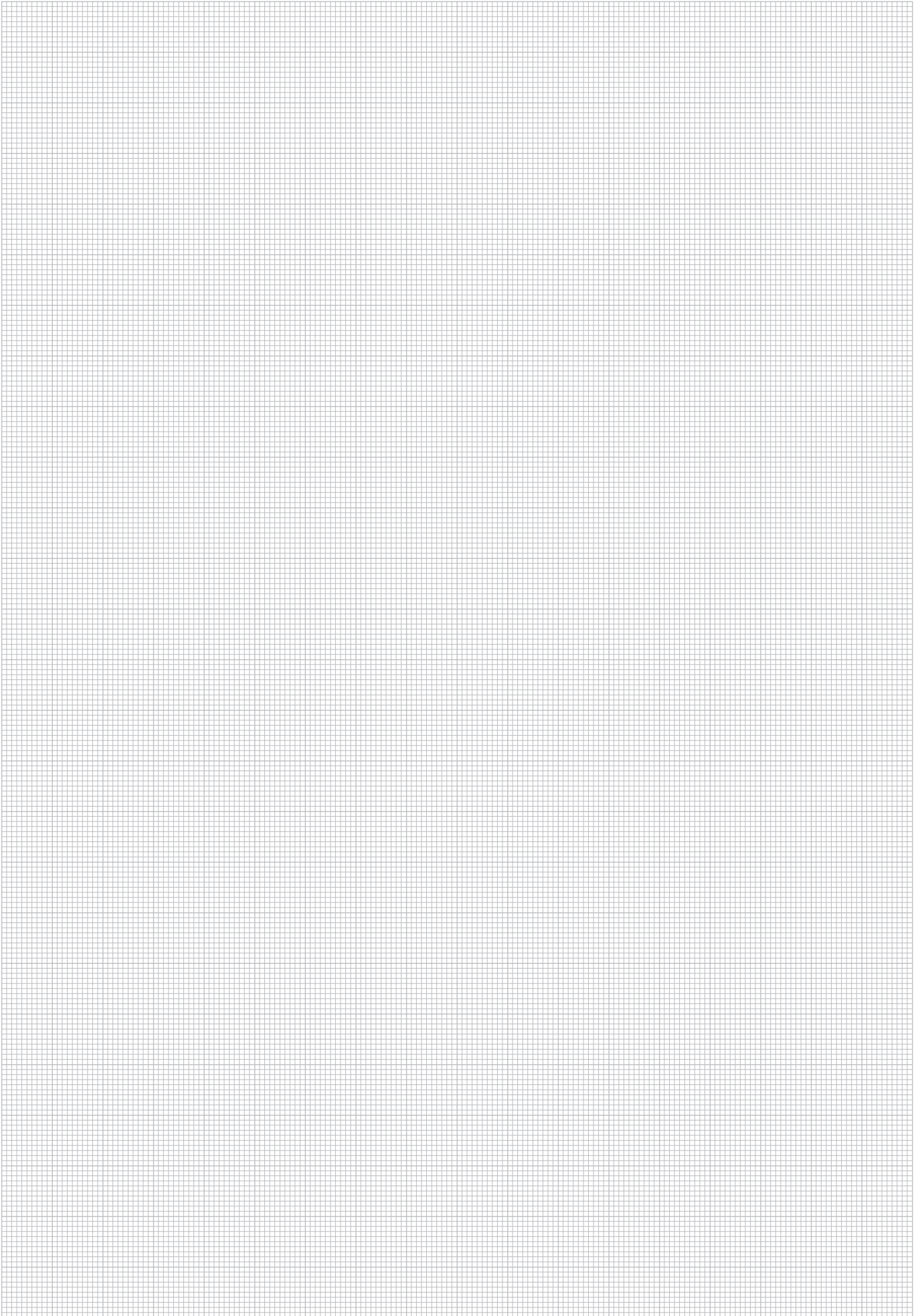

T



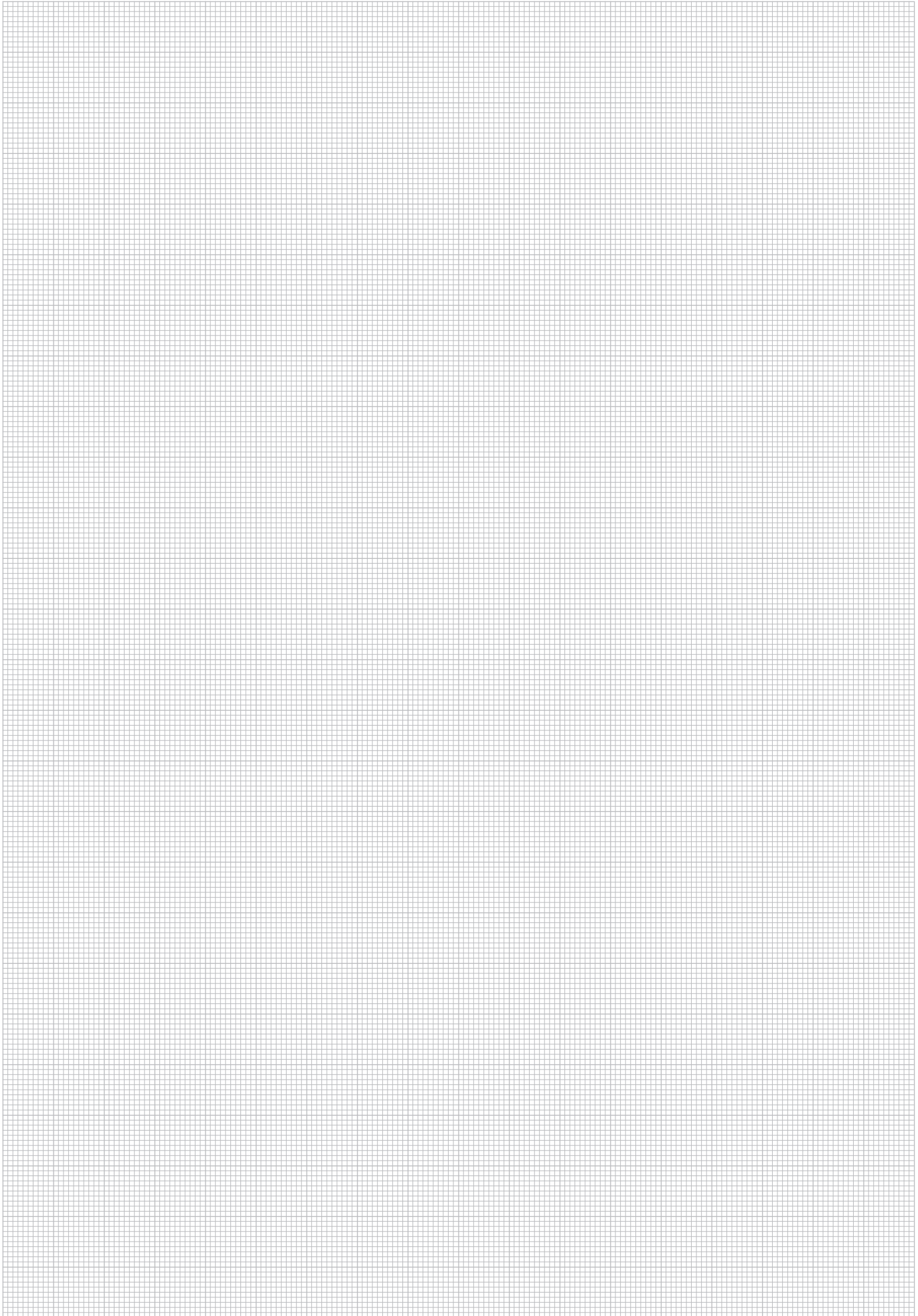

T



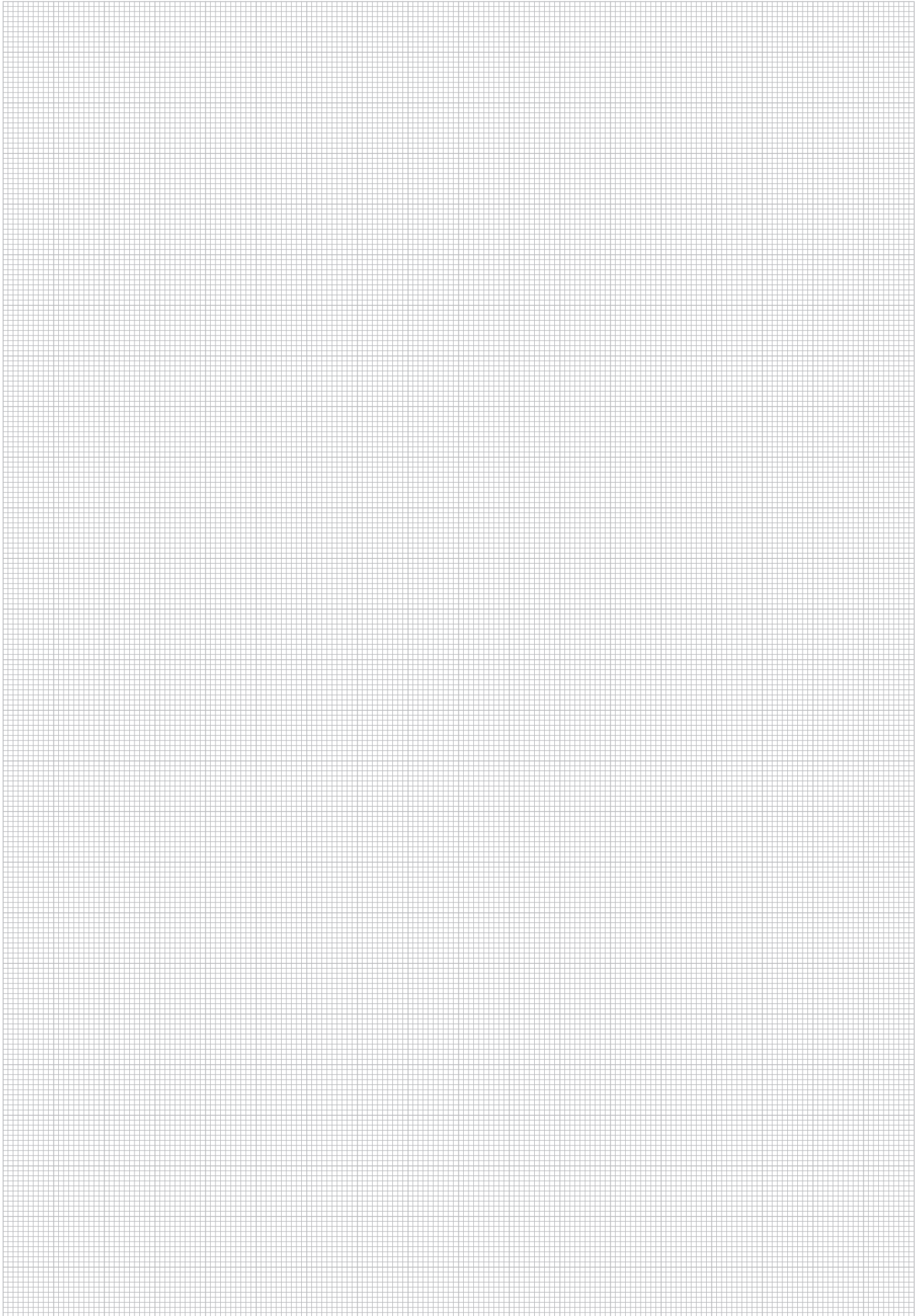

T



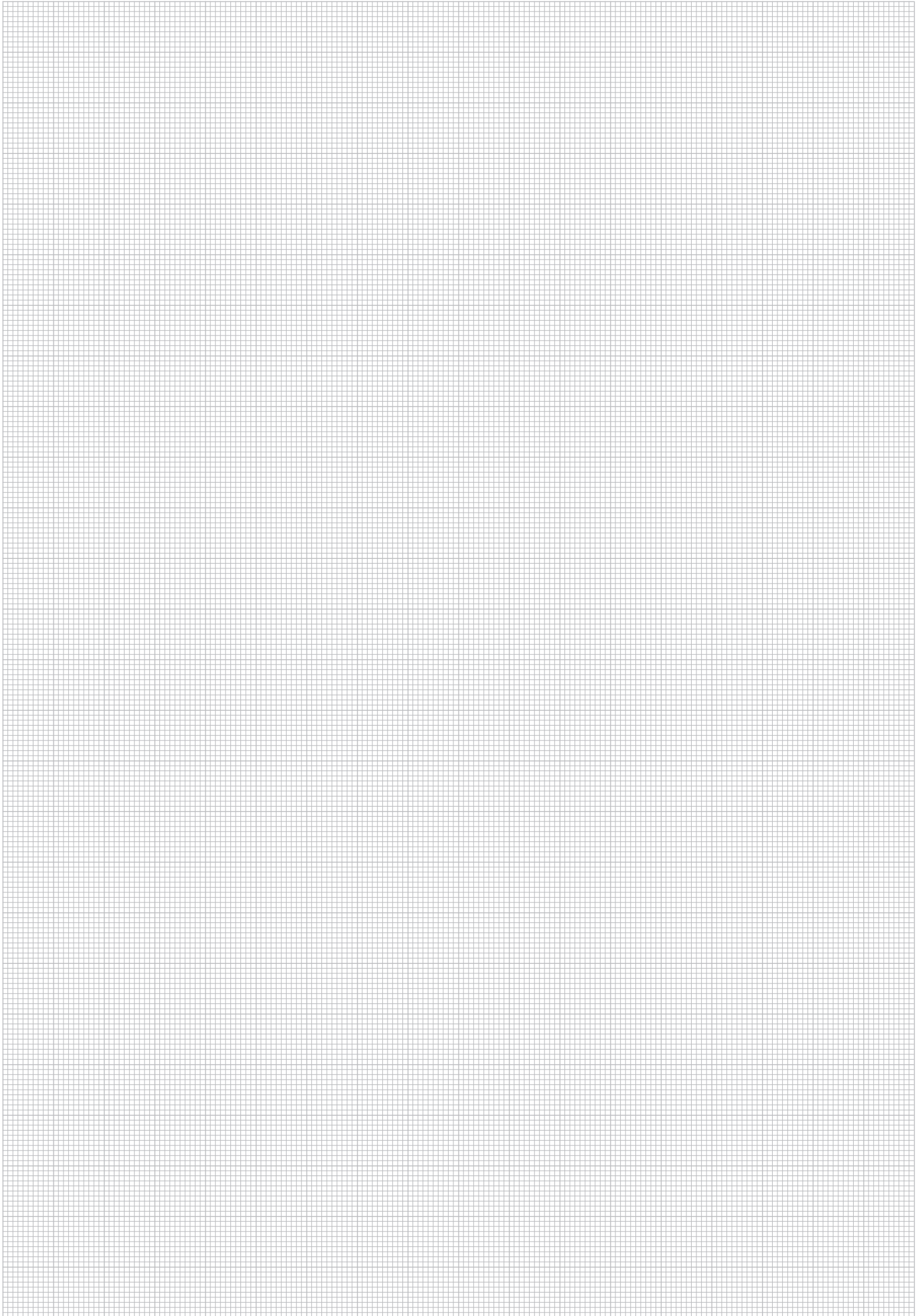

T







<b>Product-Specific Abbreviations</b>	346
<b>Global Contact Directory</b>	350



## Product-Specific Abbreviations

Abbreviation	Product Category	Product Description	Page
FI-AB	Connecting Parts	37° Flared Tube Fitting Set	37
FI-AS	Weld Fittings	Straight Weld Fitting	114
FI-ASV	Weld Fittings	Straight Weld Fitting for Tubes	120
FI-BA	Connecting Parts	24°/37° Flared Cone Adaptor with O-Rings	34
FI-BH	Connecting Parts	Support Sleeve for 37° Flared Tube Fittings	35
FI-BM	Connecting Parts	Union Nut for 37° Flared Tube Fittings	36
FI-Box-... (FI-KOL-...)	Measuring and Test Equipment	Cone Gauge Kit	277
FI-BUZ	Spare Parts / Accessories	Blanking Plug with Sealing Edge	235
FI-DGWE-...-M-WD	Swivel Fittings	Swivel Elbow	197
FI-DGWE-...-R-WD	Swivel Fittings	Swivel Elbow	196
FI-DIR	Spare Parts / Accessories	Retaining Ring with Captive Seal for Male Studs of Banjo Fittings	245
FI-DKI	Spare Parts / Accessories	Internal Metallic Sealing Ring for Female Studs of Gauge Fittings	246
FI-DKR	Spare Parts / Accessories	External Metallic Sealing Ring for Male Studs of Banjo Fittings	244
FI-DS	Connecting Parts	Double-Edge Cutting Ring	28
FI-EGE-...-M	Standpipe Fittings	Straight Male Stud Standpipe Fitting	157
FI-EGE-...-M-WD	Standpipe Fittings	Straight Male Stud Standpipe Fitting	160
FI-EGE-...-N	Standpipe Fittings	Straight Male Stud Standpipe Fitting	161
FI-EGE-...-R	Standpipe Fittings	Straight Male Stud Standpipe Fitting	156
FI-EGE-...-R-WD	Standpipe Fittings	Straight Male Stud Standpipe Fitting	158
FI-EGED-...-M-WD	Fittings with 24° Taper / O-Ring (DKO)	Straight Male Stud Fitting with 24° Taper / O-Ring	136
FI-EGED-...-N	Fittings with 24° Taper / O-Ring (DKO)	Straight Male Stud Fitting with 24° Taper / O-Ring	137
FI-EGED-...-R-WD	Fittings with 24° Taper / O-Ring (DKO)	Straight Male Stud Fitting with 24° Taper / O-Ring	134
FI-EL	Standpipe Fittings	Adjustable Standpipe Barrel Tee	168
FI-ELD	Fittings with 24° Taper / O-Ring (DKO)	Adjustable Barrel Tee with 24° Taper / O-Ring (DKO)	153
FI-EMA-...-R	Female Stud / Gauge Fittings	Gauge Standpipe Fitting	131
FI-EMAD-...-R	Female Stud / Gauge Fittings	Gauge Fitting with 24° Taper / O-Ring	130
FI-ES	Bulkhead Fittings	Straight Bulkhead Weld Fitting	110
FI-ET	Standpipe Fittings	Adjustable Standpipe Branch Tee	167
FI-ETD	Fittings with 24° Taper / O-Ring (DKO)	Adjustable Branch Tee with 24° Taper / O-Ring (DKO)	152
FI-EVD	Fittings with 24° Taper / O-Ring (DKO)	Adjustable Elbow (45°) with 24° Taper / O-Ring	151
FI-EW	Standpipe Fittings	Adjustable Standpipe Elbow	166
FI-EWD	Fittings with 24° Taper / O-Ring (DKO)	Adjustable Elbow (90°) with 24° Taper / O-Ring	150
FI-FB	Assembly Tools / Devices	Clamping Jaws	271
FI-FD	Connecting Parts	STAUFF Form EVO Sealing Ring	32
FI-FK	Assembly Tools / Devices	Final Assembly Stud for the Manual Cutting Ring Assembly	250
FI-FST	Assembly Tools / Devices	Tube Shapers	270
FI-G	Tube Fittings / Unions	Straight Union	96
FI-G	Tube Fittings / Unions	Straight Reducer	97
FI-GA-...-M	Female Stud / Gauge Fittings	Straight Female Stud Fitting	126
FI-GA-...-N	Female Stud / Gauge Fittings	Straight Female Stud Fitting	127
FI-GA-...-R	Female Stud / Gauge Fittings	Straight Female Stud Fitting	124
FI-GE-...-M	Male Stud Fittings	Straight Male Stud Fitting	44
FI-GE-...-Mk	Male Stud Fittings	Straight Male Stud Fitting	64
FI-GE-...-M-OR	Male Stud Fittings	Straight Male Stud Fitting	57
FI-GE-...-M-WD	Male Stud Fittings	Straight Male Stud Fitting	52
FI-GE-...-N	Male Stud Fittings	Straight Male Stud Fitting	65
FI-GE-...-R	Male Stud Fittings	Straight Male Stud Fitting	40
FI-GE-...-R-DF	Male Stud Fittings	Straight Male Stud Fitting	55
FI-GE-...-Rk	Male Stud Fittings	Straight Male Stud Fitting	60
FI-GE-...-R-WD	Male Stud Fittings	Straight Male Stud Fitting	48
FI-GE-...-U	Male Stud Fittings	Straight Male Stud Fitting	70
FI-GP	Assembly Tools / Devices	Support Plate for Machine-Assisted Assembly	255
FI-GP-PRC	Assembly Tools / Devices	Support Plate for Machine-Assisted Cutting Ring Assembly	262
FI-GS	Bulkhead Fittings	Straight Bulkhead Fitting	108
FI-ID	Assembly Tools / Devices	Internal Tube Supports	270
FI-K	Tube Fittings / Unions	Equal Cross	104
FI-KB	Assembly Tools / Devices	Clamping Jaws for 37° Tube Flaring	263
FI-KR	Spare Parts / Accessories	Retaining Ring (Small) for Male Studs of Fittings with Lock Nut	247
FI-LE-...-M	Male Stud Fittings	Male Stud Barrel Tee	89
FI-LE-...-Mk	Male Stud Fittings	Male Stud Barrel Tee	91
FI-LE-...-N	Male Stud Fittings	Male Stud Barrel Tee	92
FI-LE-...-R	Male Stud Fittings	Male Stud Barrel Tee	88
FI-LE-...-Rk	Male Stud Fittings	Male Stud Barrel Tee	90
FI-LEE-...-M-OK	Fittings with Lock Nut	Adjustable Male Stud Barrel Tee with Lock Nut	175
FI-LEE-...-M-OR	Fittings with Lock Nut	Adjustable Male Stud Barrel Tee with Lock Nut	177
FI-LEE-...-R-OK	Fittings with Lock Nut	Adjustable Male Stud Barrel Tee with Lock Nut	173
FI-LEE-...-U	Fittings with Lock Nut	Adjustable Male Stud Barrel Tee with Lock Nut	179
FI-M	Connecting Parts	Union Nut	33
FI-MA-...-R	Female Stud / Gauge Fittings	Gauge Fitting	129
FI-MFK	Assembly Tools / Devices	Cutting Ring Assembly Stud for Machine-Assisted Assembly	254
FI-MFK	Assembly Tools / Devices	Cutting Ring Assembly Stud for Machine-Assisted Assembly	261
FI-MVK-PRC-H-M	Assembly Tools / Devices	Cutting Ring Assembly Stud for Machine-Assisted Assembly	266
FI-RED-...-R	Spare Parts / Accessories	Thread Reducer	226
FI-RED-...-R-WD	Spare Parts / Accessories	Thread Reducer	224
FI-REDS	Standpipe Fittings	Straight Standpipe Reducer	162
FI-RST-...-M-DK	Banjo Fittings	Banjo Tee (High-Pressure Version)	191
FI-RST-...-M-WD	Banjo Fittings	Banjo Tee (High-Pressure Version)	193
FI-RST-...-R-DK	Banjo Fittings	Banjo Tee (High-Pressure Version)	190
FI-RSW-...-M-WD	Banjo Fittings	Banjo Elbow (High-Pressure Version)	189



## Product-Specific Abbreviations

Abbreviation	Product Category	Product Description	Page
FI-RST-...-R-WD	Banjo Fittings	Banjo Tee (High-Pressure Version)	192
FI-RSW-...-M-DK	Banjo Fittings	Banjo Elbow (High-Pressure Version)	187
FI-RSW-...-R-DK	Banjo Fittings	Banjo Elbow (High-Pressure Version)	186
FI-RSW-...-R-WD	Banjo Fittings	Banjo Elbow (High-Pressure Version)	188
FI-RSWND-...-M-DK	Banjo Fittings	Banjo Elbow (Medium-Pressure Version)	183
FI-RSWND-...-M-WD	Banjo Fittings	Banjo Elbow (Medium-Pressure Version)	185
FI-RSWND-...-R-DK	Banjo Fittings	Banjo Elbow (Medium-Pressure Version)	183
FI-RSWND-...-R-WD	Banjo Fittings	Banjo Elbow (Medium-Pressure Version)	184
FI-RV	Hydraulic Valves	Check Valve	200
FI-RVA	Hydraulic Valves	Check Valve	201
FI-RVI-...-R	Hydraulic Valves	Female Stud Check Valve	210
FI-RVIA-...-R	Hydraulic Valves	Female Stud Check Valve	211
FI-RV-...-M-WD	Hydraulic Valves	Male Stud Check Valve	203
FI-RV-...-R-WD	Hydraulic Valves	Male Stud Check Valve	202
FI-RVVA-...-M-WD	Hydraulic Valves	Male Stud Check Valve	205
FI-RVVA-...-R-WD	Hydraulic Valves	Male Stud Check Valve	204
FI-RVZ-...-M-WD	Hydraulic Valves	Male Stud Check Valve	207
FI-RVZ-...-R-WD	Hydraulic Valves	Male Stud Check Valve	206
FI-RVZA-...-M-WD	Hydraulic Valves	Male Stud Check Valve	209
FI-RVZA-...-R-WD	Hydraulic Valves	Male Stud Check Valve	208
FI-S	Connecting Parts	Single-Edge Cutting Ring	28
FI-SKM	Spare Parts / Accessories	Hexagon Lock Nut	237
FI-SN	Weld Fittings	24° Weld Cone with O-Ring	116
FI-SNR	Weld Fittings	24° Weld Cone Reducer with O-Ring	118
FI-SNV	Fittings with 24° Taper / O-Ring (DKO)	Straight Male Stud Fitting with 24° Taper / O-Ring	138
FI-SNV	Fittings with 24° Taper / O-Ring (DKO)	Straight Reducer with 24° Taper / O-Ring	140
FI-T	Tube Fittings / Unions	Equal Tee	100
FI-T	Tube Fittings / Unions	Tee Reducer	101
FI-TE-...-M	Male Stud Fittings	Male Stud Branch Tee	83
FI-TE-...-Mk	Male Stud Fittings	Male Stud Branch Tee	85
FI-TE-...-N	Male Stud Fittings	Male Stud Branch Tee	86
FI-TE-...-R	Male Stud Fittings	Male Stud Branch Tee	82
FI-TE-...-Rk	Male Stud Fittings	Male Stud Branch Tee	84
FI-TEE-...-M-OK	Fittings with Lock Nut	Adjustable Male Stud Branch Tee with Lock Nut	175
FI-TEE-...-M-OR	Fittings with Lock Nut	Adjustable Male Stud Branch Tee with Lock Nut	177
FI-TEE-...-R-OK	Fittings with Lock Nut	Adjustable Male Stud Branch Tee with Lock Nut	173
FI-TEE-...-U	Fittings with Lock Nut	Adjustable Male Stud Branch Tee with Lock Nut	179
FI-TIB	Measuring and Test Equipment	Thread Identification Board	276
FI-VD	Spare Parts / Accessories	Blanking Plug with 24° Taper / O-Ring (DKO)	234
FI-VEE-...-M-OK	Fittings with Lock Nut	Adjustable Male Stud Elbow (45°) with Lock Nut	175
FI-VEE-...-M-OR	Fittings with Lock Nut	Adjustable Male Stud Elbow (45°) with Lock Nut	177
FI-VEE-...-R-OK	Fittings with Lock Nut	Adjustable Male Stud Elbow (45°) with Lock Nut	173
FI-VEE-...-U	Fittings with Lock Nut	Adjustable Male Stud Elbow (45°) with Lock Nut	179
FI-VES	Hydraulic Valves	Check Valve Installation Kit	212
FI-VH	Connecting Parts	Support Sleeve	31
FI-VK	Assembly Tools / Devices	Pre-Assembly Stud for the Manual Cutting Ring Assembly	251
FI-VS-...-M-OR	Spare Parts / Accessories	Blanking Screw for Ports	233
FI-VS-...-M-WD	Spare Parts / Accessories	Blanking Screw for Ports	231
FI-VS-...-R	Spare Parts / Accessories	Blanking Screw for Ports	232
FI-VS-...-R-WD	Spare Parts / Accessories	Blanking Screw for Ports	230
FI-VSK	Spare Parts / Accessories	Blanking Plug for Tube Ends	236
FI-VSV-...-M-WD	Spare Parts / Accessories	Blanking Screw for Ports (Heavy Duty)	229
FI-VSV-...-R-WD	Spare Parts / Accessories	Blanking Screw for Ports (Heavy Duty)	228
FI-W	Tube Fittings / Unions	Straight Reducer	99
FI-WAS	Weld Fittings	Elbow Weld Fitting	115
FI-WDDS	Connecting Parts	Soft-Sealing Cutting Ring	29
FI-WDDS-W5	Connecting Parts	Soft-Sealing Cutting Ring (Stainless Steel)	30
FI-WE-...-M	Male Stud Fittings	Male Stud Elbow	75
FI-WE-...-Mk	Male Stud Fittings	Male Stud Elbow	78
FI-WE-...-N	Male Stud Fittings	Male Stud Elbow	80
FI-WE-...-R	Male Stud Fittings	Male Stud Elbow	74
FI-WE-...-Rk	Male Stud Fittings	Male Stud Elbow	76
FI-WEE-...-M-OK	Fittings with Lock Nut	Adjustable Male Stud Elbow (90°) with Lock Nut	174
FI-WEE-...-M-OR	Fittings with Lock Nut	Adjustable Male Stud Elbow (90°) with Lock Nut	176
FI-WEE-...-R-OK	Fittings with Lock Nut	Adjustable Male Stud Elbow (90°) with Lock Nut	172
FI-WEE-...-U	Fittings with Lock Nut	Adjustable Male Stud Elbow (90°) with Lock Nut	178
FI-WS	Bulkhead Fittings	Elbow Bulkhead Fittings	109
FI-WV	Hydraulic Valves	Alternating Valve	213
Oel-Stauff-Form-1L	Assembly Tools / Devices	STAUFF Form EVO Oel	272
O-RING	Spare Parts / Accessories	O-Ring for Male Studs	239
O-RING	Spare Parts / Accessories	O-Ring for 24°/37° Flared Cone Adaptors	240
O-RING	Spare Parts / Accessories	O-Ring for for DKO Taper Fittings / 24° Weld Cones	242
O-RING	Spare Parts / Accessories	O-Ring for Banjo Bolts of Banjo Fittings	243
SFO/PRC-POC-FS	Assembly Tools / Devices	External Foot Control Switch	254/272
SFO-F-A-A	Assembly Tools / Devices	Tube Forming Machine	268
SFO-F-IOT	Assembly Tools / Devices	Optional Cloud connection for Tube Forming Machine	268
SPR-PRC-FS	Assembly Tools / Devices	External Foot Control Switch	260
SPR-PRC-H-SET	Assembly Tools / Devices	Portable Cutting Ring Assembly Machine with Manual Pressure Setting (Set)	264
SPR-PRC-MA-D-A	Assembly Tools / Devices	Combined Cutting Ring Assembly and 37° Tube Flaring Machine	258



## Product-Specific Abbreviations

Abbreviation	Product Category	Product Description	Page
FI-RESD	Fittings with 24° Taper / O-Ring (DKO)	Straight Reducer for Tube Ends with 24° Taper / O-Ring	144
FI-RESD	Fittings with 24° Taper / O-Ring (DKO)	Distance Adaptors with 24° Taper / O-Ring	148
SPR-PRC-POC-A-A	Assembly Tools / Devices	Cutting Ring Final Assembly Machine	252
SPR-PRC-POC-A-A-IOT	Assembly Tools / Devices	Optional Cloud connection for Cutting Ring Final Assembly Machine	256
SPR-PRC-POC-RTH	Assembly Tools / Devices	Optional tool holder for tubes with small bending radii	256
SPR-PRC-TH-C-M	Assembly Tools / Devices	Tooling Head for Cutting Ring Assembly (based on manual settings)	260
SPR-PRC-TH-C-MA	Assembly Tools / Devices	Tooling Head for Cutting Ring Assembly (based on pre-defined settings)	260
SPR-PRC-TH-F-M	Assembly Tools / Devices	Tooling Head for 37° Tube Flaring (based on manual settings)	260
SPR-TM	Assembly Tools / Devices	Assembly Tool Magazine	260
STAUFF CLEAN	Tube Manipulation	Pipe, Tube and Hose Cleaning System	280
TUB-MA	Tube Manipulation	Manual Tube Bender	282
TUBSD-MA	Tube Manipulation	Tube Bending and Saw Device	283
TUD-MA	Tube Manipulation	Tube Reamer	285
TUSD-MA	Tube Manipulation	Tube Saw Device	284
WDG	Spare Parts / Accessories	Profile Sealing Ring for Male Studs	238



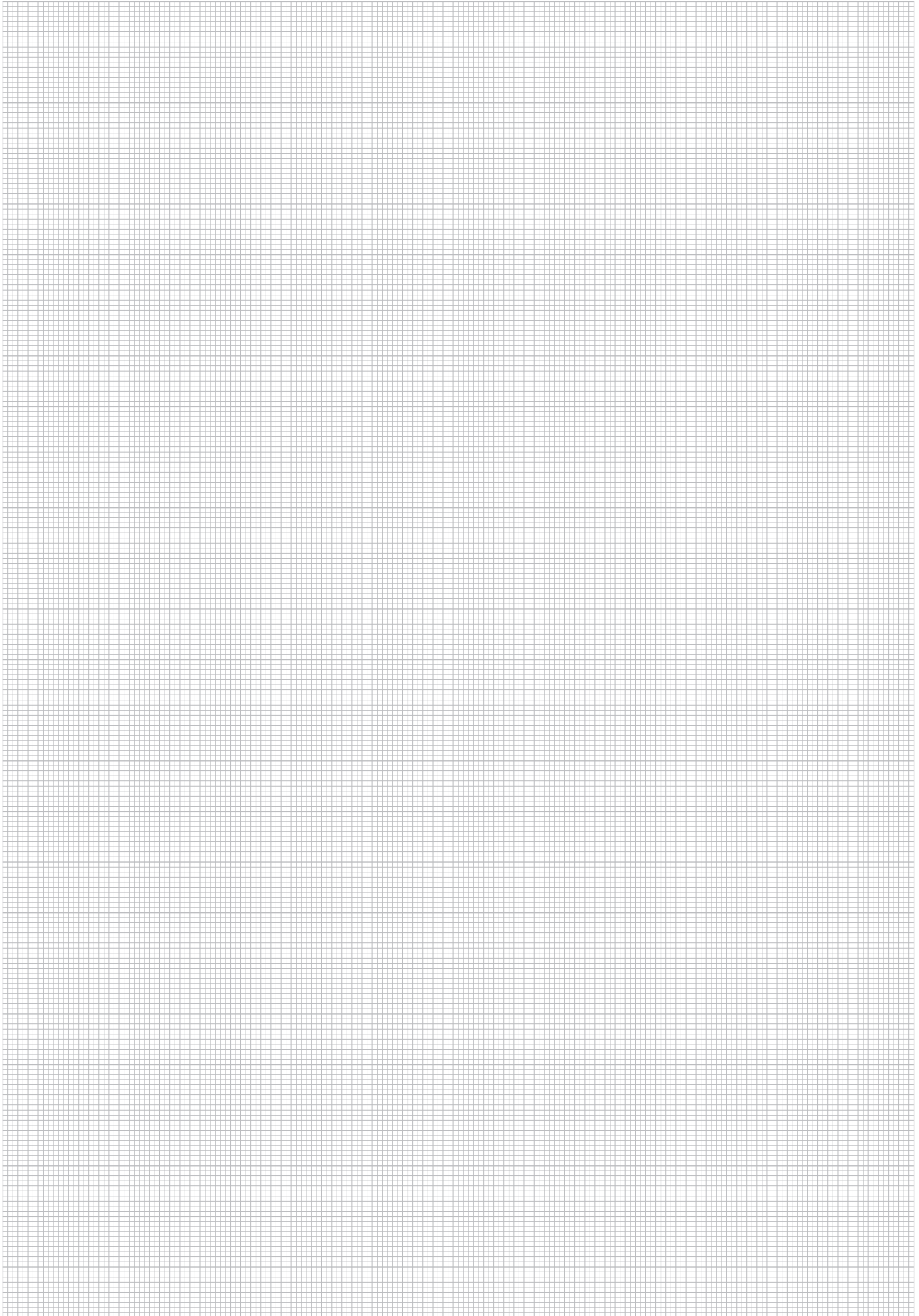

## Global Contact Directory

STAUFF products and services are globally available through wholly-owned subsidiaries and a tight network of authorised distributors and representatives in all major industrial regions of the world.

Contact information on this page may be subject to changes and additions over time. Frequently updated and complete contact information can always be found at [www.stauff.com](http://www.stauff.com).

### Germany



**Walter Stauffenberg GmbH & Co. KG**  
Im Ehrenfeld 4  
58791 Werdohl  
[www.stauff.com/contact](http://www.stauff.com/contact)

[www.stauff.com](http://www.stauff.com)



Neuenrade-Küntrop Logistics Centre  
Wasserburgstraße 35  
58809 Neuenrade



Plettenberg-Ohle Production Site  
Lennastraße 2  
58840 Plettenberg



Meinerzhagen Production Site  
Neugrünenthal  
58540 Meinerzhagen



Meinerzhagen Production Site  
Am Rottland 7  
58540 Meinerzhagen



STAUFF Digital  
Phoenixplatz 3  
44263 Dortmund

### Europe

#### France

**STAUFF S.A.S.**  
230, Avenue du Grain d'Or  
Z.I. de Vineuil - Blois Sud  
41354 Vineuil-cedex  
Tel.: +33 2 54 50 55 50  
Fax: +33 2 54 42 29 19  
E-Mail: [direction@stauffsa.com](mailto:direction@stauffsa.com)  
[www.stauff.fr](http://www.stauff.fr)

#### Ireland

**STAUFF UK Ltd.**  
Block B, 9 Ferguson Drive  
Knockmore Hill Industrial Estate  
Lisburn, County Antrim, BT28 2EX  
Tel.: +44 2892 60 69 00  
Fax: +44 2892 60 26 88  
E-Mail: [sales@stauffireland.com](mailto:sales@stauffireland.com)  
[www.stauff.co.uk](http://www.stauff.co.uk)

#### Italy

**STAUFF Italia s.r.l**  
Via Borima 21 (Frazione Borima)  
23867 Suello (LC)  
Tel.: +39 031 65 84 94  
Fax: +39 031 65 50 05  
E-Mail: [sales@stauff.it](mailto:sales@stauff.it)  
[www.stauff.it](http://www.stauff.it)

#### Poland

**STAUFF Polska Sp. z o.o.**  
Miszewko 43 A  
80-297 Banino  
Tel.: +48 58 660 11 60  
Fax: +48 58 629 79 52  
E-Mail: [sales@stauff.pl](mailto:sales@stauff.pl)  
[www.stauff.pl](http://www.stauff.pl)

#### Russian Federation

**STAUFF LLC**  
Building 1  
19, Leninskaya Sloboda  
Moscow, 115280  
Tel.: +7 495 276 16 50  
Fax: +7 495 276 16 51  
E-Mail: [sales@stauff.ru](mailto:sales@stauff.ru)  
[www.stauff.ru](http://www.stauff.ru)

#### United Kingdom

**STAUFF UK Ltd.**  
500, Carlisle Street East  
Off Downgate Drive  
Sheffield, S4 8BS  
Tel.: +44 114 251 85 18  
Fax: +44 114 251 85 19  
E-Mail: [sales@stauff.co.uk](mailto:sales@stauff.co.uk)  
[www.stauff.co.uk](http://www.stauff.co.uk)

**STAUFF UK Ltd.**  
Badentoy Avenue  
Badentoy Industrial Estate  
Portlethen, Aberdeen, AB12 4YB  
Tel.: +44 1224 78 61 66  
Fax: +44 1224 78 61 77  
E-Mail: [sales@stauffscotland.co.uk](mailto:sales@stauffscotland.co.uk)  
[www.stauff.co.uk](http://www.stauff.co.uk)

**STAUFF UK Ltd.**  
Unit 9, Southampton Trade Park  
Third Avenue, Millbrook  
Southampton, SO15 0AD  
Tel.: +44 2380 69 87 00  
Fax: +44 2380 69 87 01  
E-Mail: [sales@stauffsouthampton.co.uk](mailto:sales@stauffsouthampton.co.uk)  
[www.stauff.co.uk](http://www.stauff.co.uk)

Further branch offices in  
Engels, Volzhskiy, Magnitogorsk,  
Nizhny Novgorod and St. Petersburg.



## Global Contact Directory

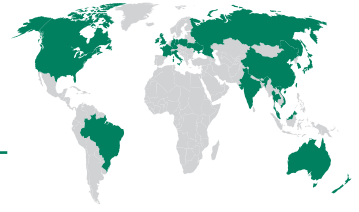

## North America

## Canada

**STAUFF Canada Ltd.**  
866 Milner Avenue  
Scarborough  
Ontario M1B 5N7  
Tel.: +1 416 282 46 08  
Fax: +1 416 282 30 39  
E-Mail: sales@stauffcanada.com  
[www.stauffcanada.com](http://www.stauffcanada.com)

## United States

**STAUFF Corporation**  
7 Wm. Demarest Place  
Waldwick, 07463-1542  
New Jersey  
Tel.: +1 201 444 78 00  
Fax: +1 201 444 78 52  
E-Mail: sales@stauffusa.com  
[www.stauffusa.com](http://www.stauffusa.com)

Further branch office in  
Canton, Michigan.

## South America

## Brazil

**STAUFF Brasil Ltda.**  
Avenida Gupê 10767  
Galpão 2 - Bloco A  
Barueri, São Paulo, CEP 06422-120  
Tel.: +55 11 47 72 72 00  
Fax: +55 11 47 72 72 10  
E-Mail: stauff@stauffbrasil.com  
[www.stauffbrasil.com](http://www.stauffbrasil.com)

## Asia

## China

**STAUFF CHINA**  
Building 8, No. 1698, Minyi Road  
Songjiang District,  
Shanghai, 201612  
Tel.: +86 21 68 18 70 00  
Fax: +86 21 68 18 71 36  
E-Mail: info@stauff.com.cn  
[www.stauff.com.cn](http://www.stauff.com.cn)

Further branch offices in Beijing,  
Changsha, Chengdu, Changchun,  
Chongqing, Jinan, Harbin, Guangzhou,  
Shenyang, Wuhan, Xian and Xuzhou.

## India

**STAUFF India Pvt. Ltd.**  
Gat no. 26/1 & 27, Sanghar Warehousing  
Pune - Nagar Road  
Lonikand - 412216  
Tel.: +91 20 6731 4900  
Fax: +91 20 6731 4905  
E-Mail: sales@stauffindia.com  
[www.stauffindia.com](http://www.stauffindia.com)

## Korea

**STAUFF Korea Ltd.**  
105, Hwajeonsandan 5-ro  
Gangseo-gu  
Busan, 46739  
Tel.: +82 51 266 6666  
Fax: +82 51 266 8866  
E-Mail: info@stauff.co.kr  
[www.stauff.co.kr](http://www.stauff.co.kr)

## Singapore

**STAUFF (SEA) Pte. Ltd.**  
128 Joo Seng Road #02-01  
Singapore 368356  
Tel.: +65 62 44 61 68  
E-Mail: sales\_sg@stauff.com  
[www.stauff.com.sg](http://www.stauff.com.sg)

## Thailand

**STAUFF (Thailand) Co., Ltd.**  
10 Soi On-Nut 74/4  
Pravet District  
Bangkok 10250  
Tel.: +66 2 721 73 23 / 24  
Fax: +66 2 721 73 35  
E-Mail: sales@stauff.co.th  
[www.stauff.co.th](http://www.stauff.co.th)

## Vietnam

**STAUFF Vietnam Ltd.**  
2nd Floor, CT-IN Building  
#435 Hoang Van Thu Street  
Tan Binh District, Ho Chi Minh City  
Tel.: +84 8 3948 10 41 / 42  
Fax: +84 8 3948 10 44  
E-Mail: sales@stauff.com.vn  
[www.stauff.com.vn](http://www.stauff.com.vn)

## Oceania

## Australia

**STAUFF Corporation Pty Ltd**  
24-26 Doyle Avenue  
Unanderra NSW 2526  
Tel.: +61 2 4271 9000  
Fax: +61 2 4271 8432  
E-Mail: sales@stauff.com.au  
[www.stauff.com.au](http://www.stauff.com.au)

Further branch offices in  
Adelaide, Brisbane, Melbourne  
and Sydney.

## New Zealand

**STAUFF Corporation (NZ) Ltd.**  
Unit D, 103 Harris Road  
East Tamaki, Auckland 2013  
Tel.: +64 9 912 1530  
Fax: +64 9 912 1531  
E-Mail: sales@stauff.co.nz  
[www.stauff.co.nz](http://www.stauff.co.nz)



Introduction

System Overview

Connecting Parts

Male Stud Fittings

Tube Fittings / Unions

Bulkhead Fittings

Weld Fittings

Female Stud / Gauge Fittings

Fittings with 24° Taper / O-Ring (DKO)

Standpipe Fittings

Fittings with Lock Nut

Banjo Fittings

Swivel Fittings

Hydraulic Valves

Custom-Designed Solutions

Spare Parts / Accessories

Assembly Tools / Devices

Measuring and Test Equipment

Tube Manipulation

Assembly Instructions

Technical Appendix

Appendix



## Catalogue 2 STAUFF Connect

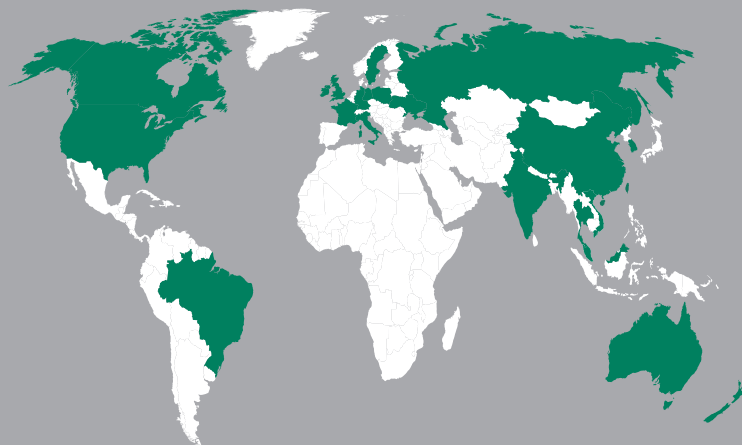

### Germany

Walter Stauffenberg GmbH & Co. KG  
Im Ehrenfeld 4  
58791 Werdohl

STAUFF products and services are globally available through wholly-owned subsidiaries and a tight network of authorised distributors and representatives in all major industrial regions of the world.

Contact STAUFF:

[www.stauff.com/contact](http://www.stauff.com/contact)