

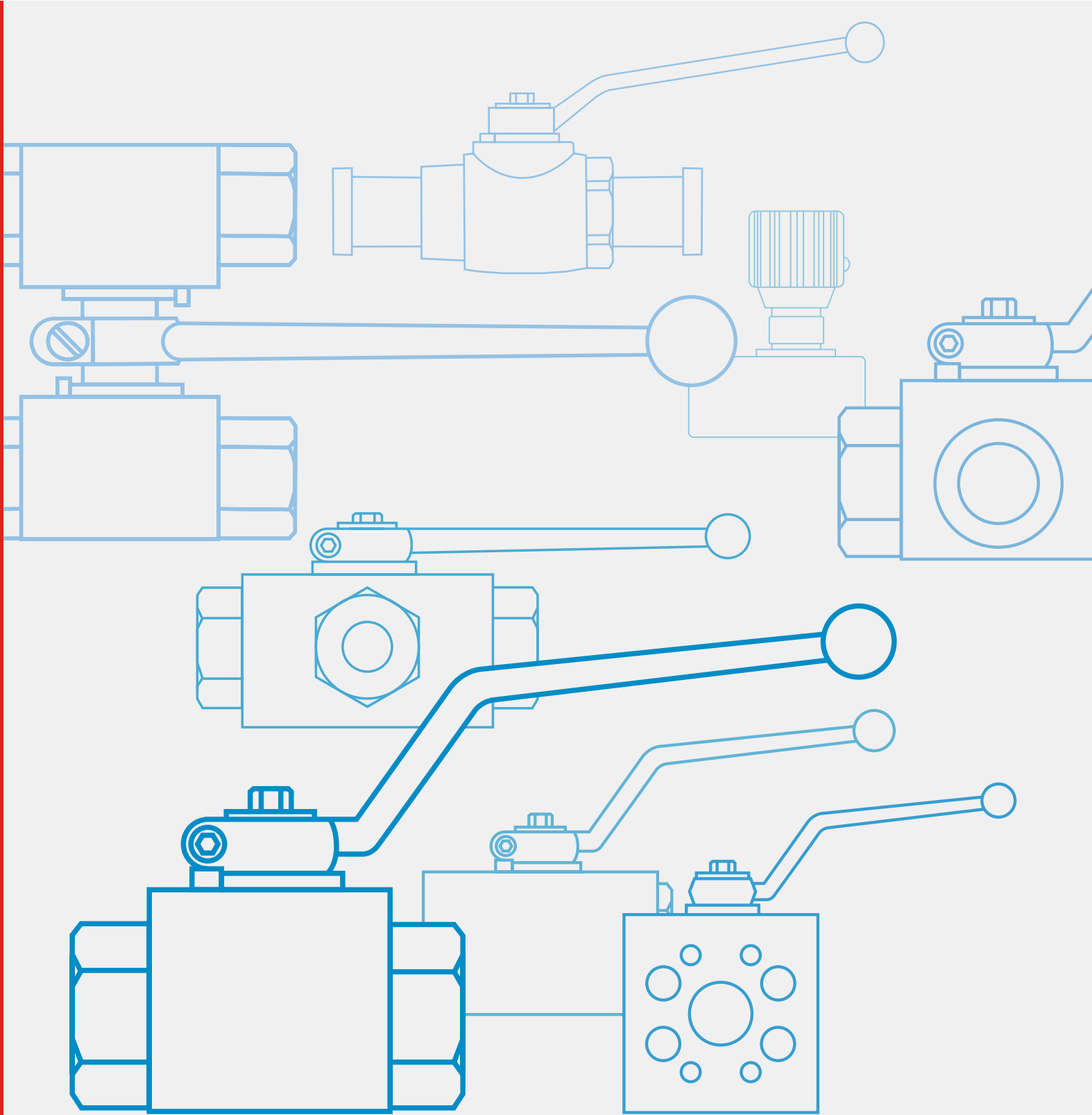

MHA ZENTGRAF
FlowControl Technology

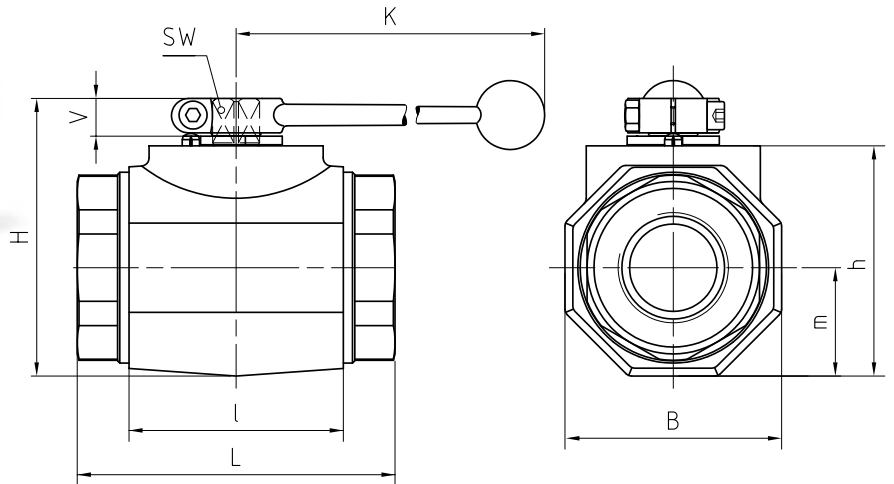

Two-way

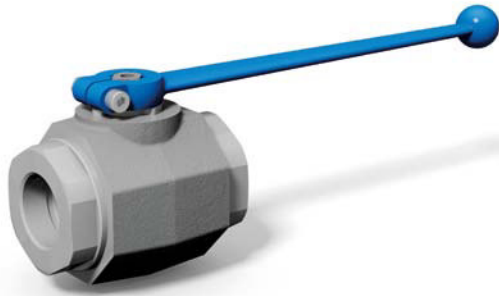

AVAILABLE SIZES

DN32 - DN50 (1 1/4" to 2")

CONNECTIONS

DIN ISO 228 Female thread, ANSI B1.20.1 NPT Female thread, DIN 2353/ISO 8434-1 Light / Heavy series, SAE J 514/ISO/DIS11926-1 Female thread, others on request

ACCESSORIES ON REQUEST

- Locking devices page 226 - 229
- Actuators 224 - 225
- Mounting holes 24
- Position switches 232 - 233
- Combinations 192 - 193
- Detent on request

MATERIAL CODE DESCRIPTION

Materials	112A	1128
Body	Steel	Steel
Ball	Steel	Steel
Stem	Steel	Steel
Ball seats	POM	POM
O-rings	NBR	FPM
Tmin /Tmax	-20°C / 100°C	-20°C / 100°C

GENERAL DIMENSIONS

Type	l	B 8Kt	H	h	m	V	SW	K	Lever
MKHP420-DN32	80	81	107	86	40,5	16,5	17	320	Al
MKHP420-DN40	85	100	124	103	50	16,5	17	320	Al
MKHP420-DN50	100	118	138	117	59	16,5	17	320	Al

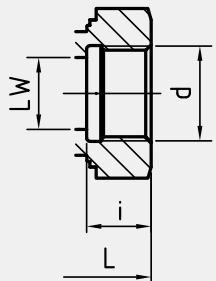
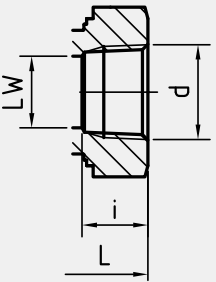
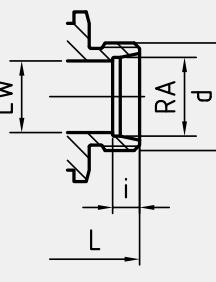
CONNECTION TYPE	DIMENSIONS						ORDER CODE PER MATERIAL COMBINATION			
DIN ISO 228 FEMALE THREAD	Type	LW	L	i	d	Weight [Kg]	PN [bar]	112A	1128	
	MKHP420-DN32-G1 1/4	32	111	22	G1 1/4	3,47	420	43548*	43551*	
	MKHP420-DN40-G1 1/2	38	130	24	G1 1/2	5,67	420	43549*	43552*	
	MKHP420-DN50-G2	48	140	26	G2	8,14	420	43550*	43553*	
ANSI B1.20.1 NPT FEMALE THREAD	Type	LW	L	i	d	Weight [Kg]	PN [bar]	112A	1128	
	MKHP420-DN32-1 1/4"NPT	32	120	22,1	1 1/4"NPT	3,52	420	43677*	43680*	
	MKHP420-DN40-1 1/2"NPT	38	130	22,1	1 1/2"NPT	5,69	420	43678*	43681*	
	MKHP420-DN50-2"NPT	48	140	30,3	2"NPT	8,14	420	43679*	43682*	
DIN 2353 / ISO 8434-1 LIGHT SERIES	Type	LW	RA	L	i	d	Weight [Kg]	PN [bar]	112A	1128
	MKHP420-DN32-35L	32	35	136	10,5	M 45x2	3,58	420	43683*	43685*
	MKHP420-DN40-42L	38	42	147	11	M 52x2	5,54	420	43684*	43686*

Please note the pressure ratings of the tube connections!

*Article usually in stock.

Two-way

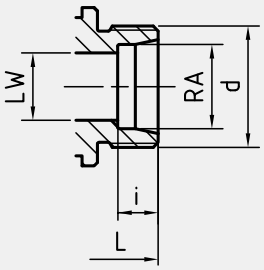
CONNECTION TYPE	DIMENSIONS							ORDER CODE PER MATERIAL COMBINATION		
DIN 2353 / ISO 8434-1 HEAVY SERIES	Type	LW	RA	L	i	d	Weight [Kg]	PN [bar]	112A	1128
	MKHP420-DN32-38S	32	38	148	16	M 52x2	3,77	420	43687*	43688*

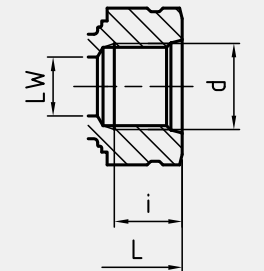
CONNECTION TYPE	DIMENSIONS						ORDER CODE PER MATERIAL COMBINATION		
SAE J514/ISO/DIS11926-1 FEMALE THREAD	Type	LW	L	i	d	Weight [Kg]	PN [bar]	112A	1128
	MKHP420-DN32-1 5/8" UN	30	111	20	1 5/8" -12 UN	3,52	420	43689*	43692*
	MKHP420-DN40-1 7/8" UN	38	130	20	1 7/8" -12 UN	5,69	420	43690*	43693*
	MKHP420-DN50-2 1/2" UN	45	140	20	2 1/2" -12 UN	7,99	420	43691*	43694*

Please note the pressure ratings of the tube connections!

*Article usually in stock.

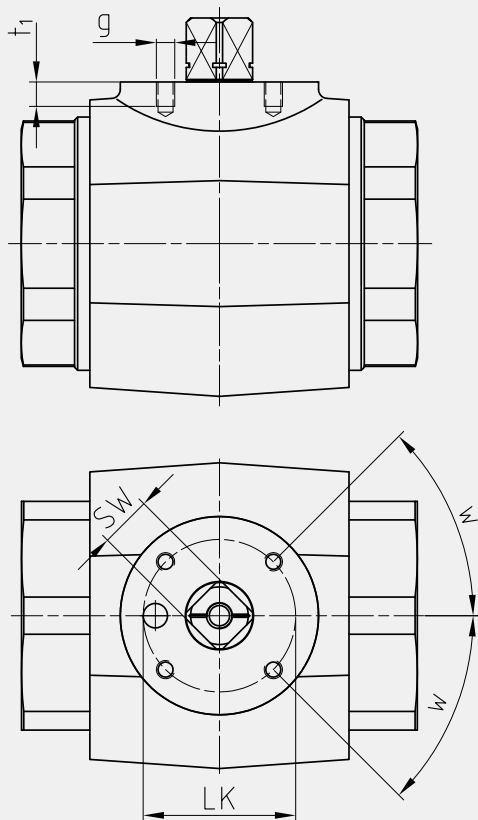

ASSEMBLING THREADS AS PER ISO 5211

DN	SW	LK	g	t ₁	w	ISO5211
32	17	50	M6	8	45°	F05
40	17	50	M6	8	45°	F05
50	17	50	M6	8	45°	F05

Ball valve Stainless Steel

MKHP420

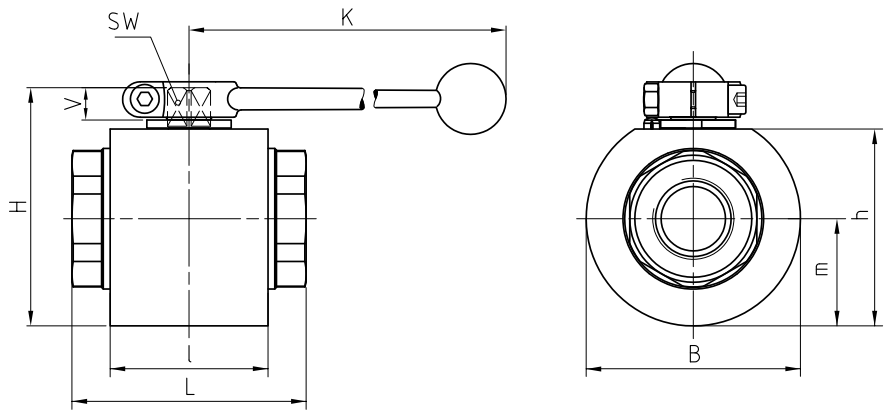
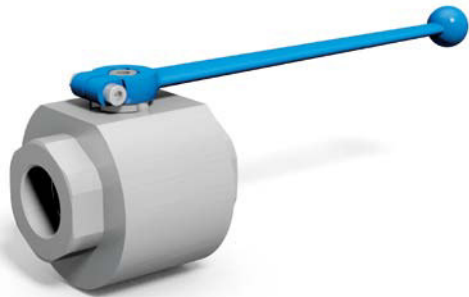

Two-way

AVAILABLE SIZES

DN32 - DN50 (1 1/4" to 2")

CONNECTIONS

DIN ISO 228 Female thread, ANSI B1.20.1 NPT Female thread, DIN 2353/ISO 8434-1 Light / Heavy series, SAE J 514/ISO/DIS11926-1 Female thread, others on request

ACCESSORIES ON REQUEST

- Locking devices page 226 - 229
- Actuators 224 - 225
- Mounting holes 28
- Position switches 232 - 233
- Combinations on request
- Detent on request

MATERIAL CODE DESCRIPTION

Materials	442A	4428
Body	Stainless Steel	Stainless Steel
Ball	Stainless Steel	Stainless Steel
Stem	Stainless Steel	Stainless Steel
Ball seats	POM	POM
O-rings	NBR	FPM
Tmin /Tmax	-30°C / 100°C	-20°C / 100°C

GENERAL DIMENSIONS

Type	l	B	H	h	m	V	SW	K	Lever
MKHP420-DN32	80	109	121	100	54,5	16,5	17	320	Al
MKHP420-DN40	85	124	136	115	62	16,5	17	320	Al
MKHP420-DN50	101	132	145	124	66	16,5	17	320	Al

Ball valve Stainless Steel

MKHP420

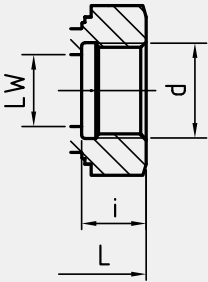
CONNECTION TYPE	DIMENSIONS						ORDER CODE PER MATERIAL COMBINATION		
DIN ISO 228 FEMALE THREAD	Type	LW	L	i	d	Weight [Kg]	PN [bar]	442A	4428
	MKHP420-DN32-G1 1/4	32	111	22	G1 1/4	5,67	420	50006*	49265*
	MKHP420-DN40-G1 1/2	38	130	24	G1 1/2	8,16	420	49271*	49102*
	MKHP420-DN50-G2	48	140	26	G2	10,45	420	49764*	51637*

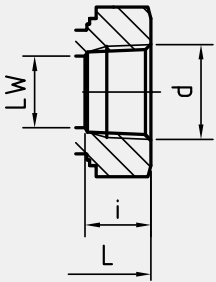
ANSI B1.20.1 NPT FEMALE THREAD	Type	LW	L	i	d	Weight [Kg]	PN [bar]	442A	4428
	MKHP420-DN32-1 1/4"NPT	32	120	22,1	1 1/4"NPT	5,72	420	48751*	53257*
	MKHP420-DN40-1 1/2"NPT	38	130	22,1	1 1/2"NPT	8,16	420	53256*	53258*
	MKHP420-DN50-2"NPT	48	140	30,3	2"NPT	10,37	420	51994*	53259*

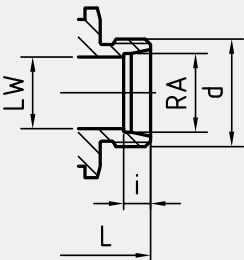
DIN 2353 / ISO 8434-1 LIGHT SERIES	Type	LW	RA	L	i	d	Weight [Kg]	PN [bar]	442A	4428
	MKHP420-DN32-35L	32	35	136	10,5	M 45x2	5,78	420	53260*	53261*
	MKHP420-DN40-42L	38	42	147	11	M 52x2	8,35	420	48766*	49335*

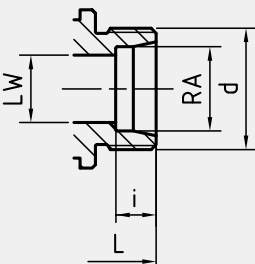
DIN 2353 / ISO 8434-1 HEAVY SERIES	Type	LW	RA	L	i	d	Weight [Kg]	PN [bar]	442A	4428
	MKHP420-DN32-38S	32	38	148	16	M 52x2	5,97	420	51699*	53262*

Two-way

Ball valve Stainless Steel

MKHP420

Two-way

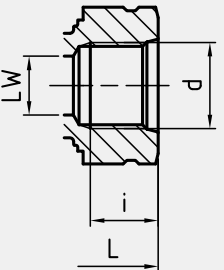
CONNECTION TYPE	DIMENSIONS						ORDER CODE PER MATERIAL COMBINATION		
SAE J514/ISO/DIS11926-1 FEMALE THREAD	Type	LW	L	i	d	Weight [Kg]	PN [bar]	442A	4428
	MKHP420-DN32-1 5/8" UN	30	111	20	1 5/8"-12 UN	5,72	420	37187*	53263*
	MKHP420-DN40-1 7/8" UN	38	130	20	1 7/8"-12 UN	8,16	420	37188*	37191*
	MKHP420-DN50-2 1/2" UN	45	140	20	2 1/2"-12 UN	9,47	420	53264*	37192*

Please note the pressure ratings of the tube connections!

*Article usually in stock.

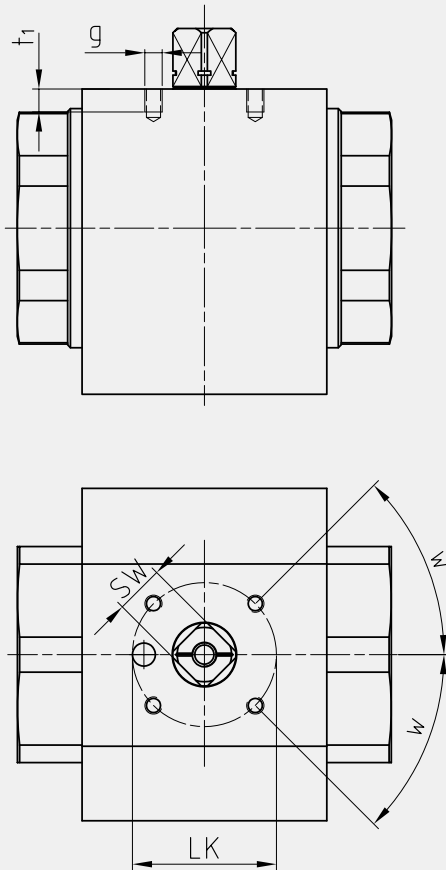

ASSEMBLING THREADS AS PER ISO 5211

DN	SW	LK	g	t ₁	w	ISO5211
32	17	50	M6	8	45°	F05
40	17	50	M6	8	45°	F05
50	17	50	M6	8	45°	F05



MHA ZENTGRAF

FlowControl Technology

2-way threaded
DN 4 to DN 50

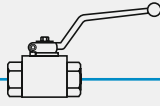

2-way SAEFS
DN 4 to DN 50

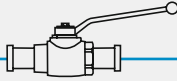

2-way flanged
DN 15 to DN 200

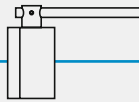

3- and 4-way
DN 6 to DN 40

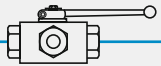

3-way selector
DN 6 to DN 50

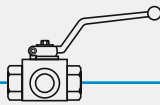

Combinations
DN 6 to DN 50

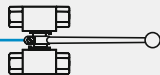

Intermediate
DN 13 to DN 50

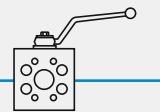

Manifold
DN 6 to DN 50

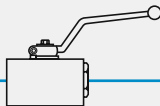

Flow control
DN 6 to DN 50

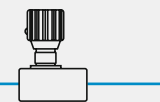

www.mha-zentgraf.com
info@mha-zentgraf.com

After a custom solution?
- Speak with us now!