



www.inteva.es

QUICK COUPLINGS





DNV BUSINESS ASSURANCE

CERTIFICADO DEL SISTEMA DE GESTIÓN

(MANAGEMENT SYSTEM CERTIFICATE)

Certificado nº 130981-2013-AQ-IBE-ENAC

*Se certifica que el sistema de gestión de la compañía
(This is to certify that the management system of the company)*

INDUSTRIAS TECNICAS DE VALVULERIA, S.A.

C/ Berguedà, 14-16 P.I. Can Bernadés Subirà, 08130, Santa Perpetua de la Mogoda, Barcelona

*es conforme a la norma
(complies with the standard)*

ISO 9001:2008

*Este certificado es válido para el siguiente campo de aplicación
(This certificate is valid for the following scope)*

**DISEÑO, FABRICACIÓN Y COMERCIALIZACIÓN DE ACOPLER RÁPIDOS, VÁLVULAS
ANTIRRETORNO Y VÁLVULAS DE CIERRE ESFÉRICO.**
DESIGN, MANUFACTURE AND SALES OF QUICK COUPLINGS, CHECK VALVES AND BALL VALVES.

*Fecha certificación inicial:
(Initial Certification date)*

19.02.2013

*Este certificado es válido hasta:
(This certificate is valid until)*

19.02.2016

*La auditoría ha sido realizada bajo la
supervisión de
(The audit has been performed under the
supervision of)*

Federico Mata
Auditor Jefe

*Lugar y fecha:
(Place and date)*

Barcelona, 19.02.2013

*Unidad acreditada
(Accredited Unit)*

DNV BUSINESS ASSURANCE ESPAÑA, S.L.

Albert Canadell
Country Manager



El incumplimiento de las condiciones establecidas en el Contrato puede dar lugar a la cancelación del certificado.
(Lack of fulfilment of conditions as set out in the Certification Agreement may render this certificate invalid.)

ACCREDITED UNIT: DNV BUSINESS ASSURANCE ESPAÑA, S.L., C/ GARROTXA, 6-8, PL. 3 OF.1, 08820, EL PRAT DE LLOBREGAT, BARCELONA, SPAIN, TEL:+34 93 4792600

www.dnvba.es

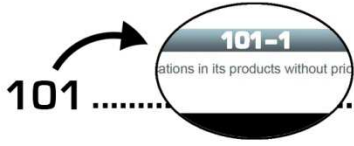

101 ISO-A Series



102 ISO-A Series (Multi-threats)



103 ISO-B Series



104 DIN Series

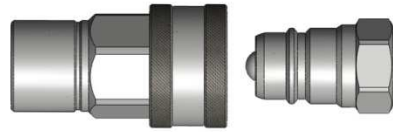

105 PSH Series



106 DIA Series



107 PSM Series



120 IFR Series



122 AGR Series

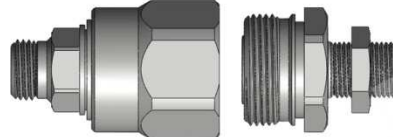

123 AGR + ISO-A Series

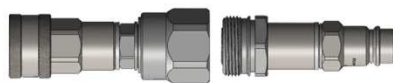

125 TFH Series



INDEX



126 TPL Series



127 JAP Series



128 TVZ Series

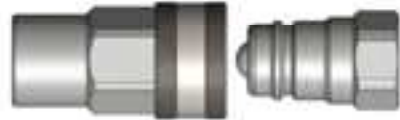

129 ISO-A Series (Safety Sleeve)



131 CPR Series



140 CVF Series



190 RBP Series



201 VCR Series



202 HPA Series



INDEX



203TGW Series

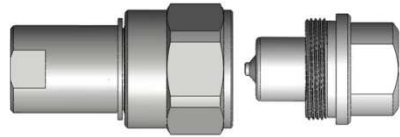

204 AEV Series

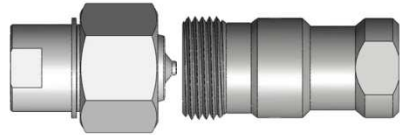

205 STG Series



206 SRK Series



207 CAT Series

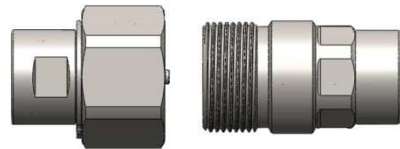

402 V2RH/V2MT Series

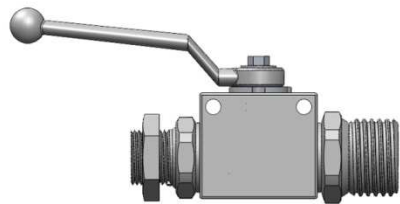

412 V2RD Series

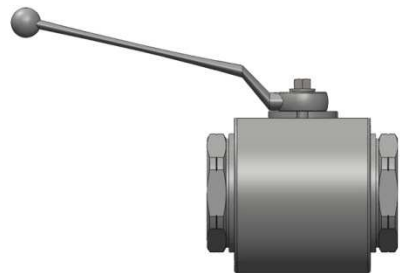

432 V3RH/V3MT Series

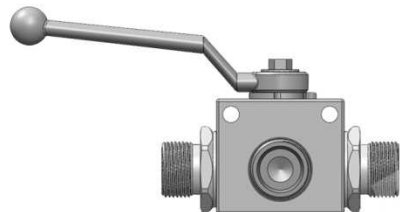

433 V3RH Series



INDEX



452 V2CR Series

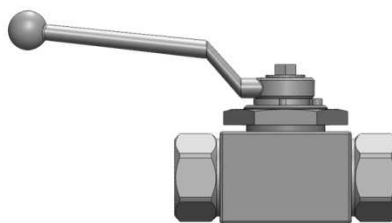

453 V3CR Series

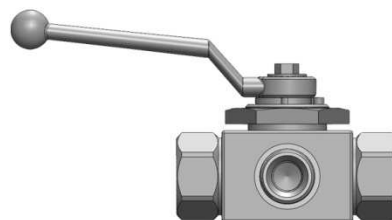

470 EK2 Series

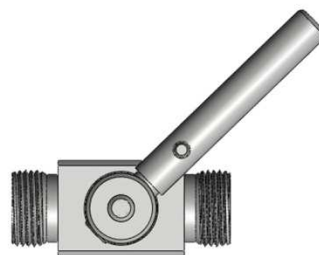

471 EK3 Series



472 VPN Series



502 VPC Series

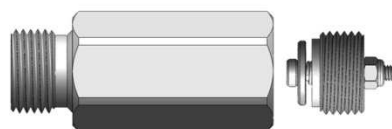

504 ATR Series

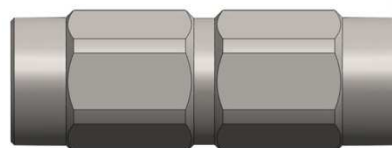

505 ATR Series

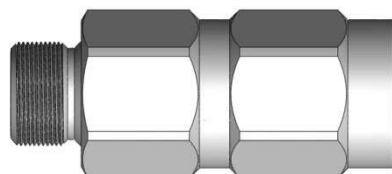

INDEX





101 SERIES ISO-A



Manufactured according ISO 7241-A norm, DN13 size meets also ISO 5675 requirements.
Poppet Valve or Ball closing system.
BSP, NPTF, SAE/ORB threads. Others available upon request.

• Materials

Body: Carbon Steel EN -10277-3
Seals: NBR, Viton or EPDM
Back-Up-Ring: PTFE
Balls: AISI 1010/1015
Springs: Carbon Steel
DIN 17233/84(B)

• Working temperature (Seals)

	NBR	Viton	EPDM
+	+100°C	+200°C	+150°C
-	-30°C	-10°C	-40°C

• **Applications:** Designed for Oil hydraulic Applications according to European Directive 97.23.EC

• **Sectors:** Industrial, Agricultural

• Equivalence

FASTER ANV
AEROQUIP FD56
PARKER 6600
SNAP-TITE 61



MODEL STRUCTURE

Example;

101.11112BC

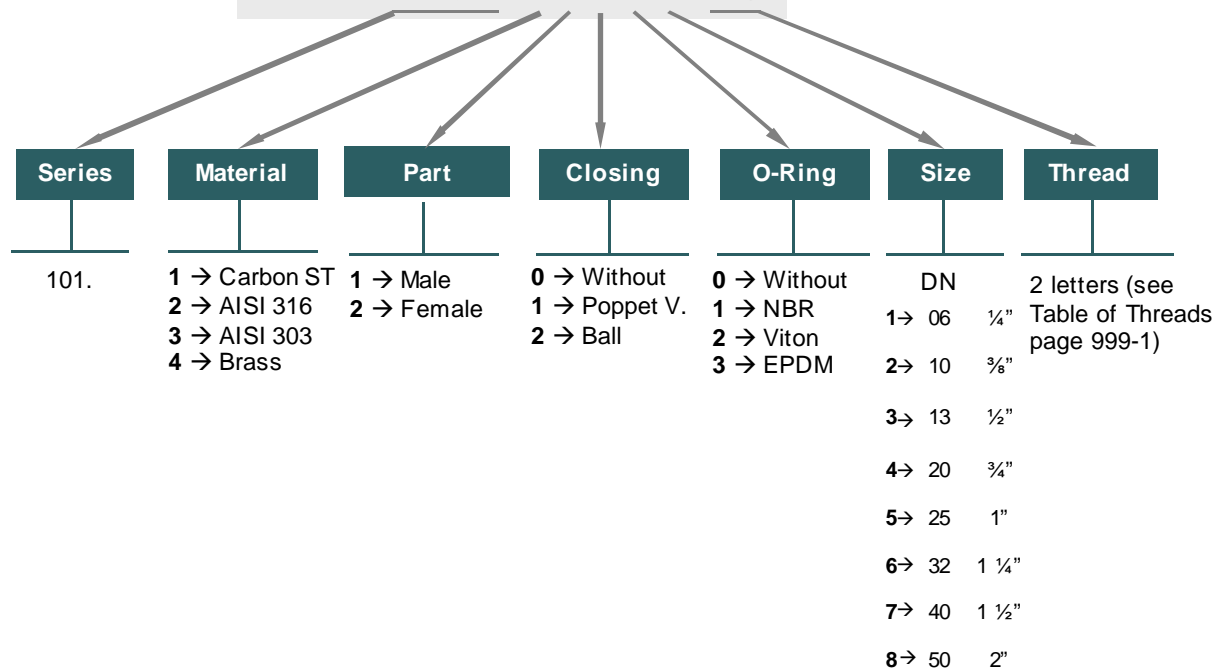

101-1





101 SERIES ISO-A

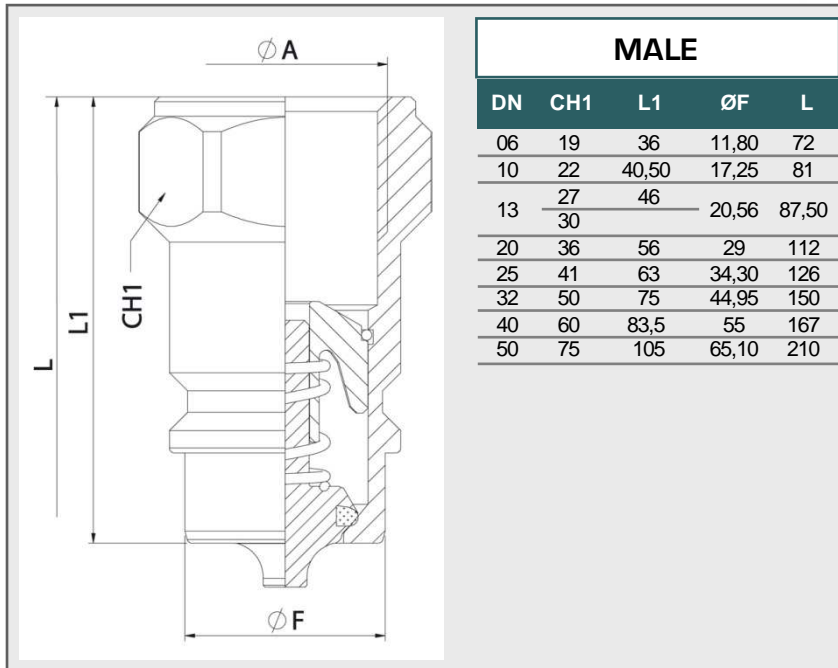

Manufactured according to ISO 7241-A norm, DN13 size meets as well ISO 5675 requirements.

L= length while quick coupling is connected.

STANDARD MODELS				
DN	ØA	MALE	FEMALE	
06	1/4" BSP	101.11111AB	101.12111AB	350Bar
	1/4" NPTF	101.11111BB	101.12111BB	
	3/8" BSP	101.11112AC	101.12112AC	
10	3/8" NPTF	101.11112BC	101.12112BC	300Bar
	3/8" BSPT	101.11112DC	101.12112DC	
	9/16" 18ORB	101.11112GC	101.12112GC	
	1/2" BSP	101.11113AD	101.12113AD	
13	1/2" NPTF	101.11113BD	101.12113BD	300Bar
	M22x1,5	101.11113NG	101.12113NG	
	3/4" - 16ORB	101.11113GF	101.12113GF	
	7/8" 14ORB	101.11113GH	101.12113GH	
	3/4" BSP	101.11114AE	101.12114AE	
20	3/4" NPTF	101.11114BE	101.12114BE	250Bar
	1 1/16" - 12ORB	101.11114GK	101.12114GK	
25	1" BSP	101.11115AF	101.12115AF	230Bar
	1" NPTF	101.11115BF	101.12115BF	
	1 5/16" - 12ORB	101.11115GO	101.12115GO	
32	1 1/4" BSP	101.11116AG	101.12116AG	230Bar
	1 1/4" NPTF	101.11116BG	101.12116BG	
40	1 1/2" BSP	101.11117AH	101.12117AH	200Bar
	1 1/2" NPTF	101.11117BH	101.12117BH	
50	2" BSP	101.11118AI	101.12118AI	130Bar
	2" NPTF	101.11118BI	101.12118BI	

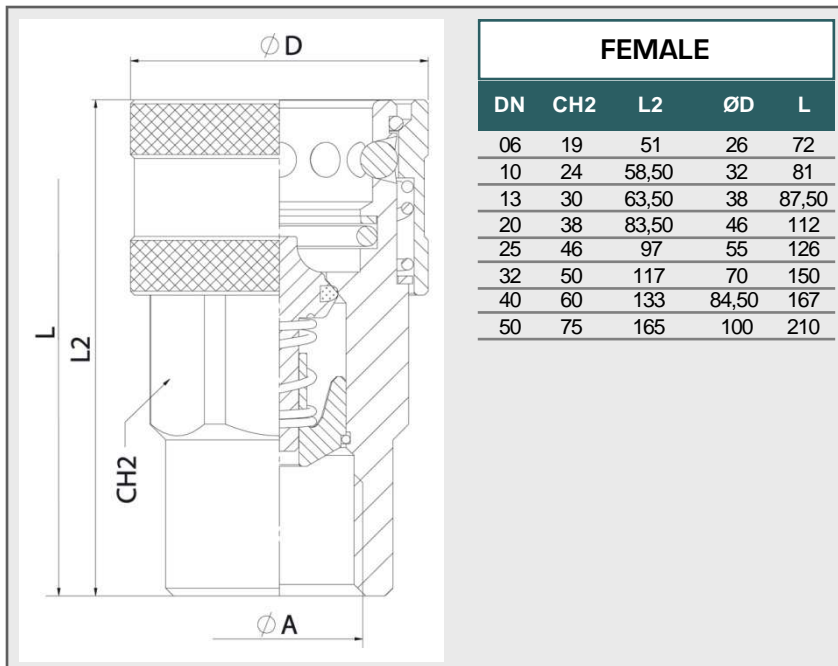

Manufactured according to ISO 7241-A norm, DN13 size meets as well ISO 5675 requirements

L= length while quick coupling is connected.





101 SERIES ISO-A



TECHNICAL DATA

DN	Rated Flow	Min Burst Pressure (bar)			Max. Working Pressure *
		Male	Female	Coupled	
06	15 l/m	1650	1800	1400	350 bar
10	35 l/m	1250	1350	1200	300 bar
13	45 l/m	1200	1300	1200	300 bar
20	74 l/m	1030	1200	1000	250 bar
25	100 l/m	950	980	920	230 bar
32	118 l/m	800	950	920	230 bar
40	410 l/m	750	850	800	200 bar
50	860 l/m	620	650	520	130 bar

* Safety factor 1:4
Data of Carbon Steel models

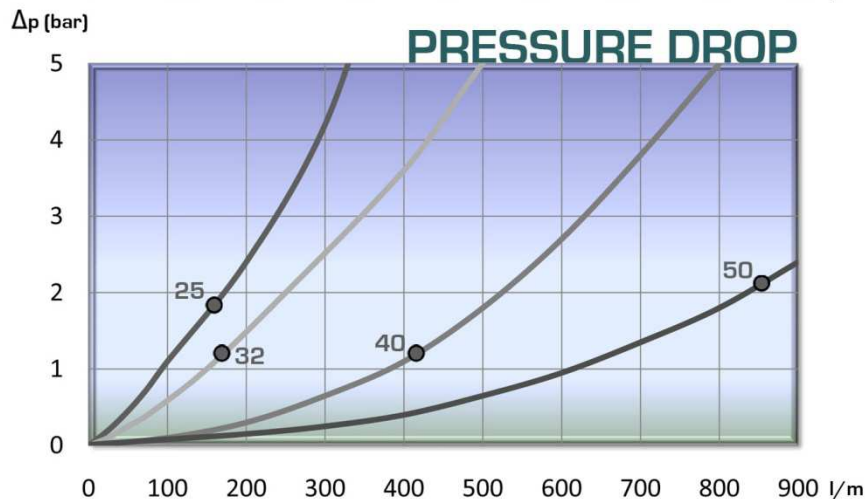
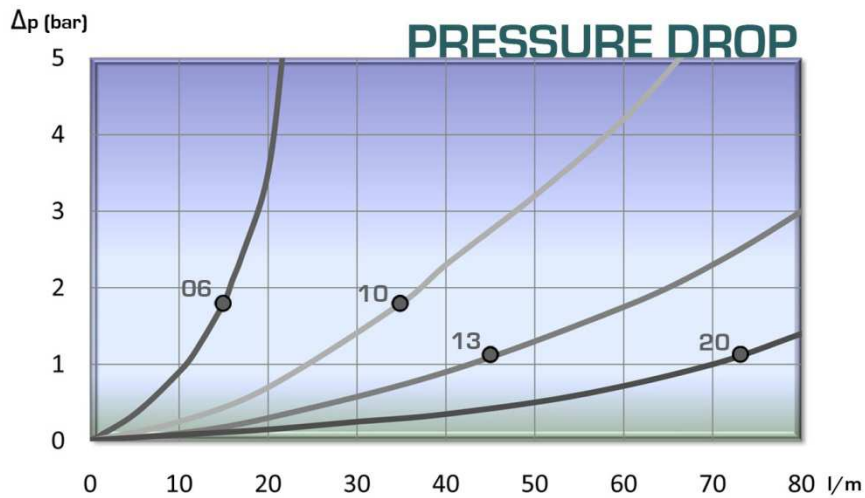

101-3





101 SERIES

ISO-A

AISI 303 / AISI 316
BRASS



Manufactured according ISO 7241-A norm, DN13 size meets also ISO 5675 requirements.
Poppet Valve or Ball closing system.
BSP, NPTF, SAE/ORB threads. Others available upon request.

• Materials

Body: *AISI 303 / AISI 316 / BRASS DIN-EN-12164*
Seals: *NBR, Viton or EPDM*
Back-Up-Ring: *PTFE*
Balls: *AISI 316W 14401*
Springs: *AISI302 DIN 17224*

• Working temperature (Seals)

	NBR	Viton	EPDM
	+100°C	+200°C	+150°C
	-30°C	-10°C	-40°C

• **Applications:** Designed for Oil hydraulic Applications according to European Directive 97.23.EC

• **Sectors:** Chemical, Industrial, Offshore Industry



• Equivalence

FASTER ANV
AEROQUIP FD56
PARKER 6600
SNAP-TITE 61

MODEL STRUCTURE

Example;

101.21113AD

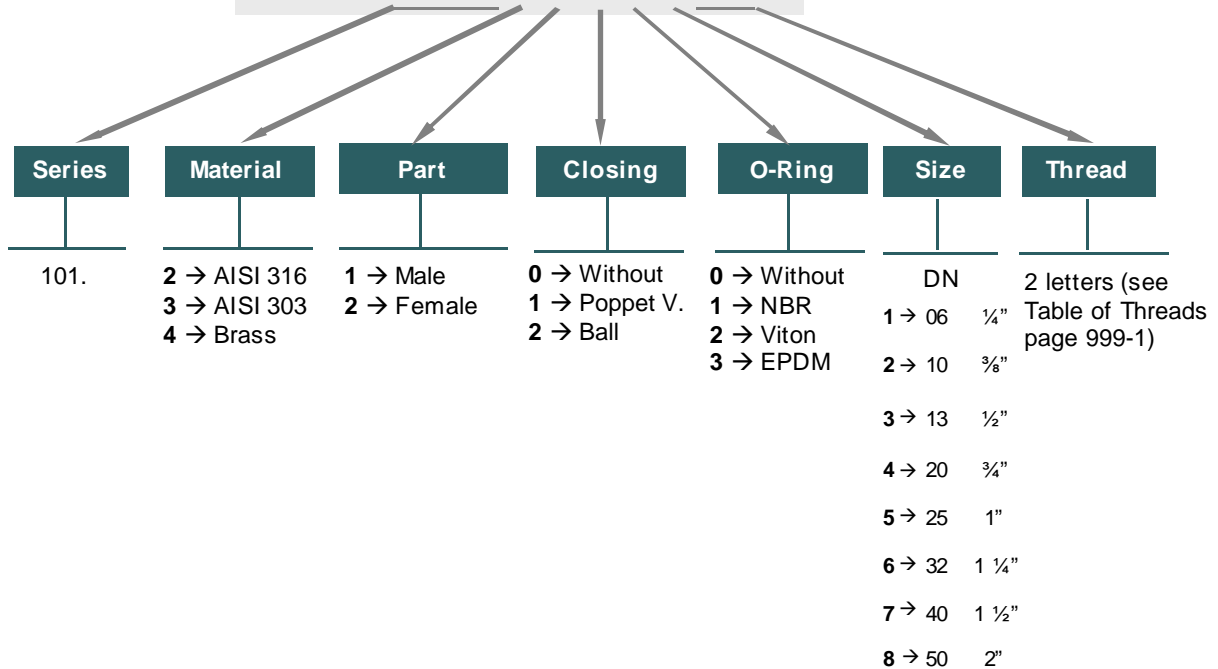

101-4





101 SERIES

ISO-A AISI 303 / AISI 316
BRASS

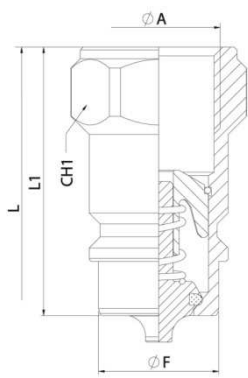

MALE				
DN	CH1	L1	ØF	L
13	27	46	20,56	87,50

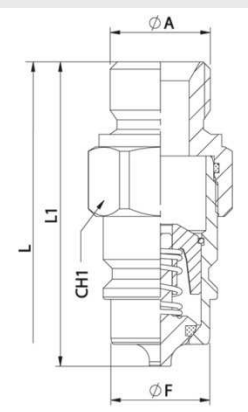

MALE				
DN	CH1	L1	ØF	L
13	27	59	20,56	83

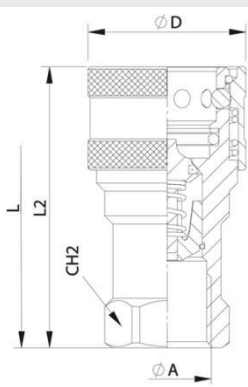

FEMALE				
DN	CH2	L2	ØD	L
13	$\frac{27}{30}$	68	38	87,50

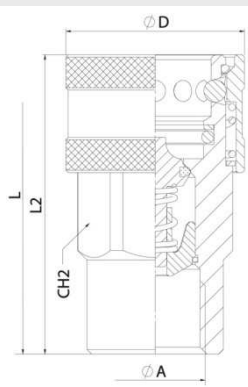

FEMALE				
DN	CH2	L2	ØD	L
13	27	68	38	83

Manufactured according to ISO 7241-A norm, DN13 size meets as well ISO 5675 requirements

STANDARD MALE MODELS				
DN	ØA	MATERIAL	REF.	
13	½" BSP	AISI 316	101.21123AD	100 Bar
		AISI 303	101.31123AD	
		BRASS	101.41123AD	80 Bar
	½" BSP M.	AISI 316	102.21123AO	100Bar

STANDARD FEMALE MODELS				
DN	ØA	MATERIAL	REF.	
13	½" BSP	AISI 316	101.22123AD	100 Bar
		AISI 303	101.32123AD	
		BRASS	101.42123AD	80 Bar



101 SERIES

ISO-A PLUGS & CAPS





ISO A SERIES PLUGS/ CAPS have been designed to protect FEMALE (coupler) or MALE (nipple) parts while they are disconnected.

Manufactured according to ISO 7241-A norm, DN13 size meets as well ISO 5675 requirements.

Example;

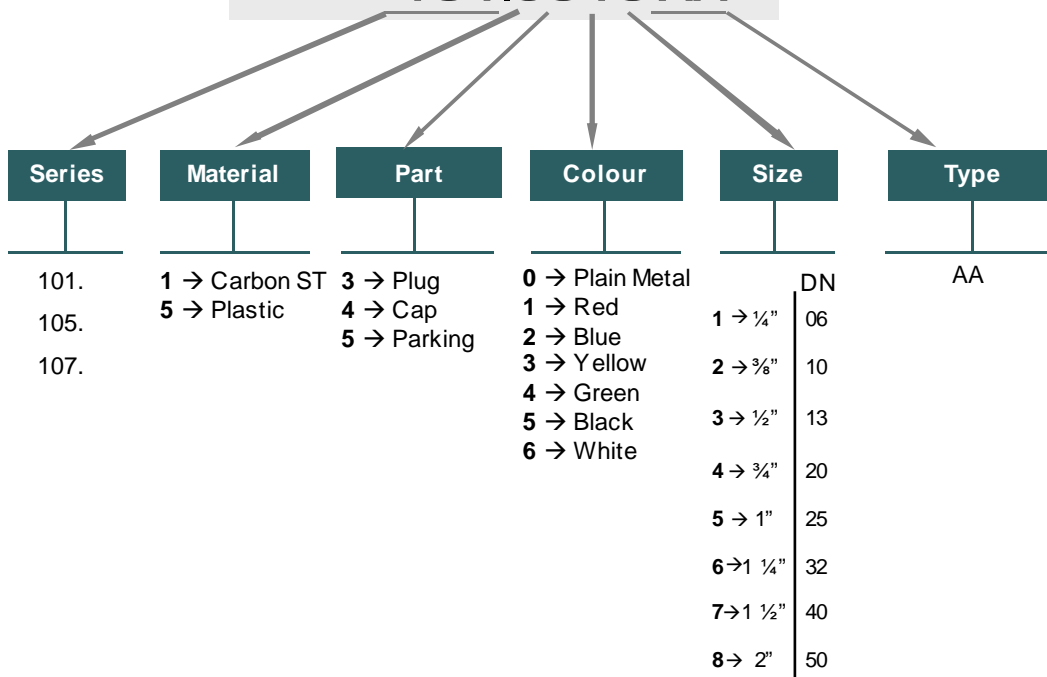
101.5313 AA





PLUG						
DN	RED	BLUE	YELLOW	GREEN	BLACK	WHITE
06	101.5311AA	*	*	*	*	*
10	101.5312AA	*	*	*	*	*
13	101.5313AA	*	*	*	*	*
20	101.5314AA	*	*	*	*	*
25	101.5315AA	*	*	*	*	*

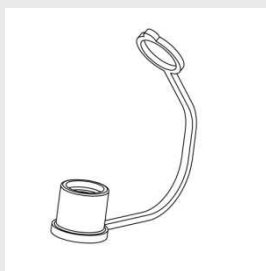

CAP						
DN	RED	BLUE	YELLOW	GREEN	BLACK	WHITE
06	101.5411AA	*	*	*	*	*
10	101.5412AA	*	*	*	*	*
13	101.5413AA	*	*	*	*	*
20	101.5414AA	*	*	*	*	*
25	101.5415AA	*	*	*	*	*

* Available upon request.



101 SERIES

ISO-A PARKINGS



PARKING 3B			
DN	REF.	ØA	L
13	101.1533AA	32	34

PARKING 1T			
DN	REF.	ØA	L
13	101.1533AC	30	38

PARKING 6B			
DN	REF.	ØA	L
13	101.1533AB	34	38



102 SERIES

ISO-A MULTI-THREADS



Manufactured according ISO 7241-A norm, DN13 size meets also ISO 5675 requirements.
 Poppet Valve or Ball closing system.
 BSP, NPTF, SAE/ORB threads. Other threads available upon request.

• Materials

Body: Carbon Steel EN -10277-3
 Seals: NBR, Viton or EPDM
 Back-Up-Ring: PTFE
 Balls: AISI 1010/1015
 Springs: Carbon Steel
 DIN 17233/84(B)

• Working temperature (Seals)

	NBR	Viton	EPDM
+	+100°C	+200°C	+150°C
-	-30°C	-10°C	-40°C

• **Applications:** Designed for Oil hydraulic Applications according to European Directive 97.23.EC

• **Sectors:** Industrial, Agricultural



• Equivalence

FASTER ANV
 AEROQUIP FD56
 PARKER 6600
 SNAP-TITE 61

MODEL STRUCTURE

Example;

102.11112JE

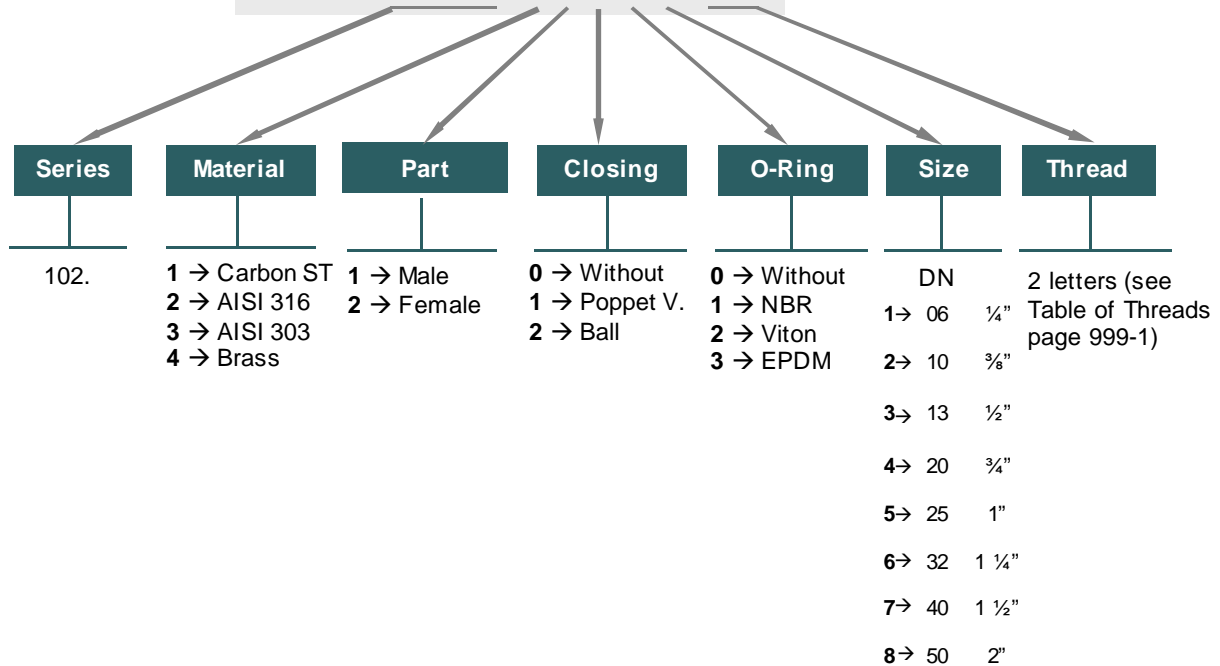

102-1





102 SERIES

ISO-A DIN 2353

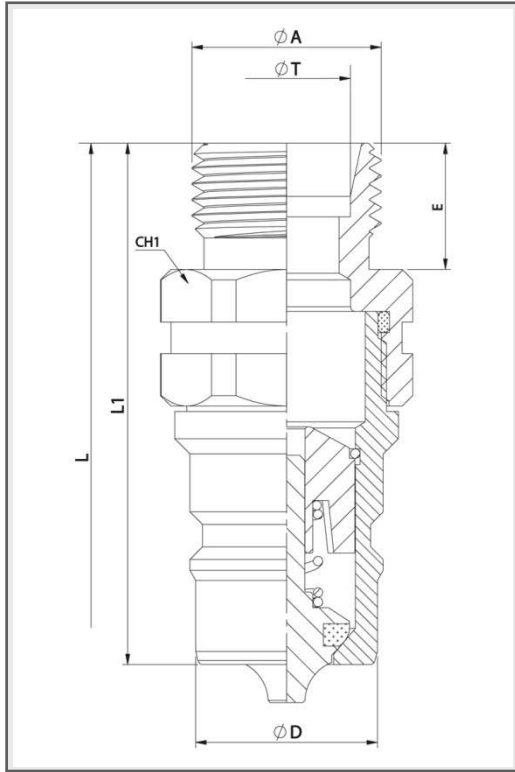

STANDARD MALE MODELS

DN	ØA	ØT	REF.		CH1	L1	ØD	E	L	Light Series
06	M12x1,5	6L	102.11111JB	350Bar	19	*	11,8	12	*	
	M14x1,5	8L	102.11111JC							
	M18x1,5	12L	102.11112JE							
10	M14x1,5	8L	102.11112JC	300Bar	22	*	17,25	12	*	
	M16x1,5	10L	102.11112JD							
	M18x1,5	12L	102.11112JE							
13	M14x1,5	8L	102.11113JC	300Bar	27	*	20,56	12	*	
	M16x1,5	10L	102.11113JD							
	M18x1,5	12L	102.11113JE							
20	M22x1,5	15L	102.11113JG	250Bar	36	*	29	12	*	
	M26x1,5	18L	102.11113JI					18		
	M18x1,5	12L	102.11114JE					12		
25	M22x1,5	15L	102.11114JG	230Bar	41	*	34,3	12	*	
	M26x1,5	18L	102.11114JI					18		
	M30x2	22L	102.11114JJ					16		
10	M16x1,5	8S	102.11112KD	300Bar	22	*	17,25	12	*	
	M18x1,5	10S	102.11112KE					12		
	M20x1,5	12S	102.11112KF					12		
	13	M18x1,5	10S	102.11113KE	300Bar	27	*	20,56	12	*
		M20x1,5	12S	102.11113KF					12	
		M22x1,5	14S	102.11113KG					12	
	20	M24x1,5	16S	102.11113KH	250Bar	36	*	29	12	*
		M24x1,5	16S	102.11114KH					16	
		M30x2	20S	102.11114KJ					16	
	25	M30x2	20S	102.11115KJ	230Bar	41	*	34,3	18	*
M36x2		25S	102.11115KK	18						
M42x2		30S	102.11115KL	46						
M52x2		38S	102.11115KN	55						

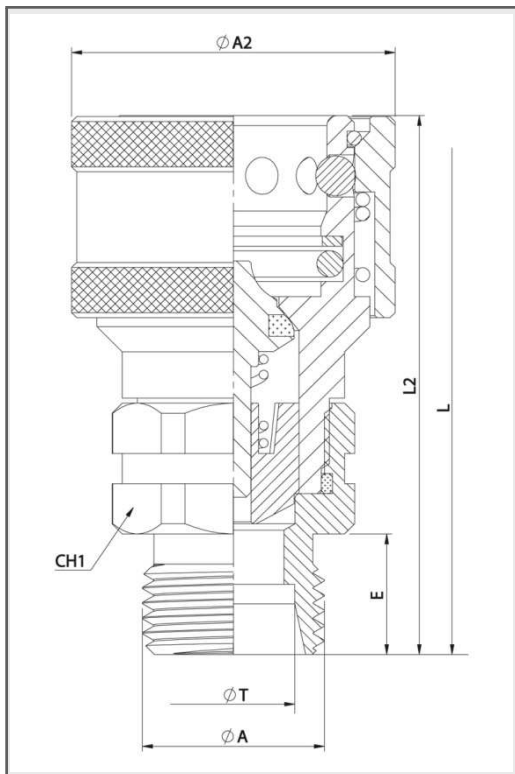

STANDARD FEMALE MODELS

DN	ØA	ØT	REF.		CH1	L2	ØA2	E	L	Light Series
06	M12x1,5	6L	102.12111JB	350Bar	19	*	26	12	*	
	M14x1,5	8L	102.12111JC							
	3/8" BSP M.	*	102.12112AN							
10	M14x1,5	8L	102.12112JC	300Bar	22	*	32	12	*	
	M16x1,5	10L	102.12112JD							
	M18x1,5	12L	102.12112JE							
13	M14x1,5	8L	102.12113JC	300Bar	27	*	38	12	*	
	M16x1,5	10L	102.12113JD							
	M18x1,5	12L	102.12113JE							
20	M22x1,5	15L	102.12113JG	250Bar	36	*	46	12	*	
	M26x1,5	18L	102.12113JI					18		
	M18x1,5	12L	102.12114JE					12		
25	M22x1,5	15L	102.12114JG	230Bar	41	*	55	18	*	
	M26x1,5	18L	102.12114JI					18		
	M30x2	22L	102.12114JJ					16		
10	M16x1,5	8S	102.12112KD	300Bar	22	*	32	12	*	
	M18x1,5	10S	102.12112KE					12		
	M20x1,5	12S	102.12112KF					12		
	13	M18x1,5	10S	102.12113KE	300Bar	27	*	38	12	*
		M20x1,5	12S	102.12113KF					12	
		M22x1,5	14S	102.12113KG					12	
	20	M24x1,5	16S	102.12113KH	250Bar	36	*	46	12	*
		M24x1,5	16S	102.12114KH					16	
		M30x2	20S	102.12114KJ					16	
	25	M30x2	20S	102.12115KJ	230Bar	41	*	55	18	*
M36x2		25S	102.12115KK	18						
M42x2		30S	102.12115KL	46						
M52x2		38S	102.12115KN	55						





102 SERIES

ISO-A DIN 2353

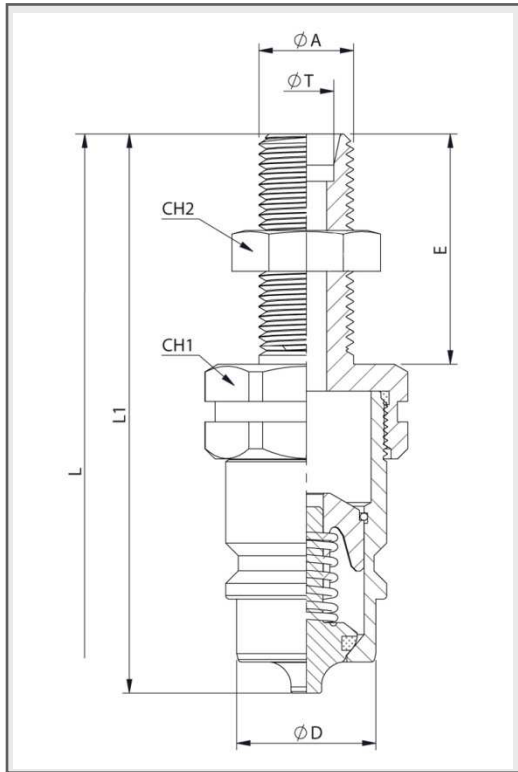

STANDARD MALE MODELS											
DN	ϕA	ϕT	REF.		CH1	CH2	L1	ϕD	E	L	
06	M12x1,5	6L	102.11111LB	350Bar	19	19	*	11,8	25	*	
	M14x1,5	8L	102.11111LC						34		
	M14x1,5	8L	102.11112LC						34		
10	M16x1,5	10L	102.11112LD	300Bar	22	22	*	17,25	26	*	
	M18x1,5	12L	102.11112LE						27		
	M14x1,5	8L	102.11113LC						19		34
13	M16x1,5	10L	102.11113LD	300Bar	27	24	*	20,56	24	*	
	M18x1,5	12L	102.11113LE						27		35
	M22x1,5	15L	102.11113LG						27		33
	M26x1,5	18L	102.11113LJ						30		33
	M18x1,5	12L	102.11114LE						24		26
20	M22x1,5	15L	102.11114LG	250Bar	36	27	*	29	33	*	
	M26x1,5	18L	102.11114LJ						30		34
	M30x2	22L	102.11114LJ						36		34
	M30x2	22L	102.11115LJ						36		34
25	M36x2	28L	102.11115LK	230Bar	41	41	*	34,3	34	*	
	M45x2	35L	102.11115LM						55		36

Light Series

10	M16x1,5	8S	102.11112MD	300Bar	22	22	*	17,25	27	*	
	M18x1,5	10S	102.11112ME						24		
	M20x1,5	12S	102.11112MF						22		24
13	M18x1,5	10S	102.11113ME	300Bar	27	22	*	20,56	24	*	
	M20x1,5	12S	102.11113MF						22		35
	M22x1,5	14S	102.11113MG						27		30
	M24x1,5	16S	102.11113MH						30		29
20	M24x1,5	16S	102.11114MH	250Bar	36	30	*	29	29	*	
	M30x2	20S	102.11114MJ						36		36
	M30x2	20S	102.11115MJ						36		35
25	M36x2	25S	102.11115MK	230Bar	41	41	*	34,3	38	*	
	M42x2	30S	102.11115ML						50		40
	M52x2	38S	102.11115MN						65		36

Heavy Series

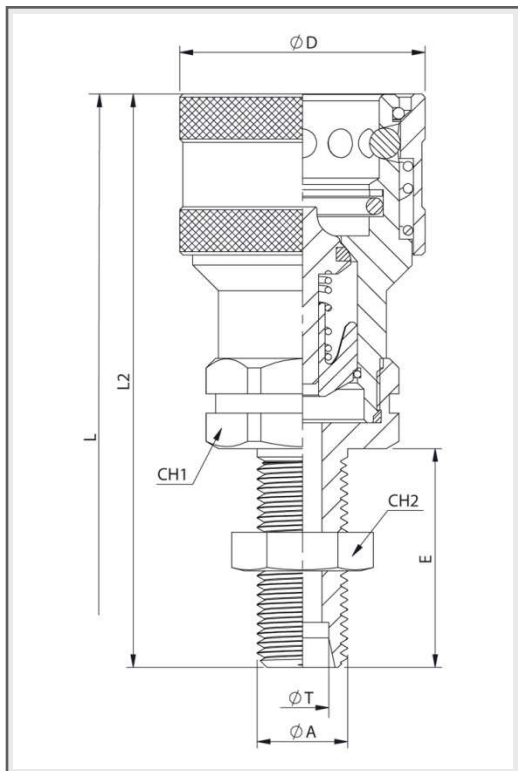

STANDARD FEMALE MODELS											
DN	ϕA	ϕT	REF.		CH1	CH2	L2	ϕD	E	L	
06	M12x1,5	6L	102.12111LB	350Bar	19	19	*	11,8	25	*	
	M14x1,5	8L	102.12111LC						34		
	M14x1,5	8L	102.12112LC						34		
10	M16x1,5	10L	102.12112LD	300Bar	22	22	*	17,25	26	*	
	M18x1,5	12L	102.12112LE						27		
	M14x1,5	8L	102.12113LC						19		34
13	M16x1,5	10L	102.12113LD	300Bar	27	24	*	20,56	24	*	
	M18x1,5	12L	102.12113LE						27		35
	M22x1,5	15L	102.12113LG						27		33
	M26x1,5	18L	102.12113LJ						30		33
	M18x1,5	12L	102.12114LE						24		26
20	M22x1,5	15L	102.12114LG	250Bar	36	27	*	29	33	*	
	M26x1,5	18L	102.12114LJ						30		34
	M30x2	22L	102.12114LJ						36		34
	M30x2	22L	102.12115LJ						36		34
25	M36x2	28L	102.12115LK	230Bar	41	41	*	34,3	34	*	
	M45x2	35L	102.12115LM						55		36

Light Series

10	M16x1,5	8S	102.12112MD	300Bar	22	22	*	17,25	27	*	
	M18x1,5	10S	102.12112ME						24		
	M20x1,5	12S	102.12112MF						22		24
13	M18x1,5	10S	102.12113ME	300Bar	27	22	*	20,56	24	*	
	M20x1,5	12S	102.12113MF						22		35
	M22x1,5	14S	102.12113MG						27		30
	M24x1,5	16S	102.12113MH						30		29
20	M24x1,5	16S	102.12114MH	250Bar	36	30	*	29	29	*	
	M30x2	20S	102.12114MJ						36		36
	M30x2	20S	102.12115MJ						36		35
25	M36x2	25S	102.12115MK	230Bar	41	41	*	34,3	38	*	
	M42x2	30S	102.12115ML						50		40
	M52x2	38S	102.12115MN						65		36

Heavy Series





102 SERIES

ISO-A MULTI-THREADS

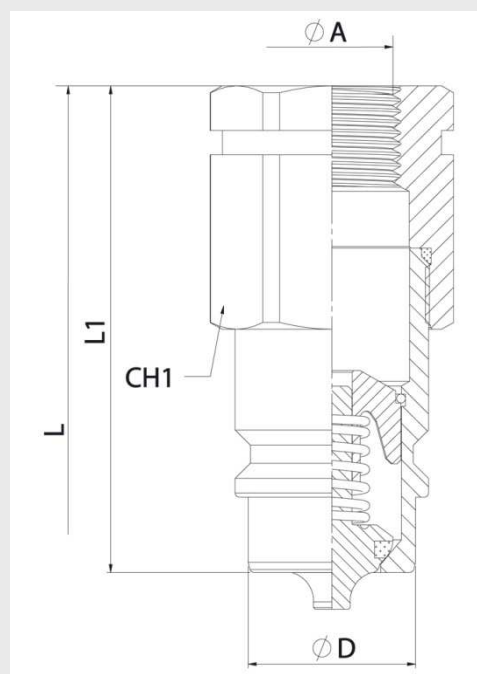
MALE				
DN	CH1	L1	ØD	L
06	19	*	11,8	*
10	22	*	17,25	*
13	27	*	20,56	*
20	36	*	29	*
25	41	*	34,3	*

STANDARD MODELS			
DN	ØA	MALE	FEMALE
06	1/4" BSP	102.11111AB	102.12111AB
	1/4" NPTF	102.11111BB	102.12111BB
10	M14x1,5	102.11111NC	102.12111NC
	1/4" BSP	102.11112AB	102.12112AB
10	3/8" BSP	102.11112AC	102.12112AC
	3/8" NPTF	102.11112BC	102.12112BC
13	M16x1,5	102.11112ND	102.12112ND
	3/8" BSP	102.11113AC	102.12113AC
13	1/2" BSP	102.11113AD	102.12113AD
	1/2" NPTF	102.11113BD	102.12113BD
13	M18x1,5	102.11113NE	102.12113NE
	M22x1,5	102.11113NG	102.12113NG
20	3/4" -16ORB	102.11113GF	102.12113GF
	7/8" -14ORB	102.11113GH	102.12113GH
20	3/4" BSP	102.11114AE	102.12114AE
	3/4" NPTF	102.11114BE	102.12114BE
25	M22x1,5	102.11114NG	102.12114NG
	1" BSP	102.11115AE	102.12115AE
25	1" BSP	102.11115AF	102.12115AF
	1" NPTF	102.11115BF	102.12115BF

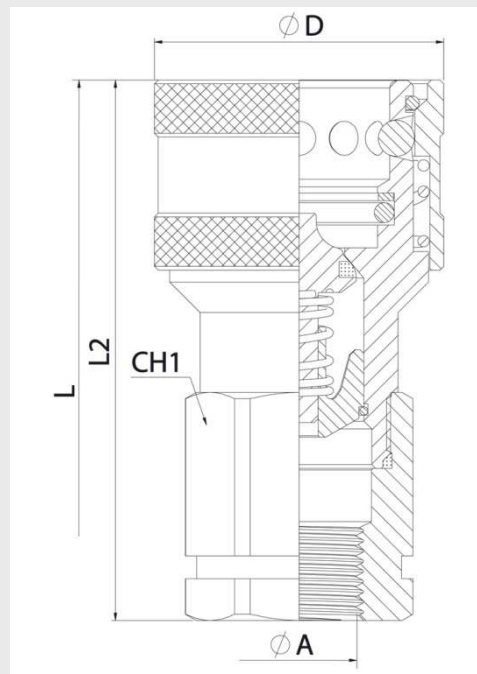

FEMALE				
DN	CH1	L2	ØD	L
06	19	*	26	*
10	22	*	32	*
13	27	*	38	*
20	36	*	46	*
25	41	*	55	*





103 SERIES

ISO-B

CARBON STEEL /
AISI 316 / BRASS



Manufactured according to ISO 7241-B norm.

Poppet Valve closing system.

BSP, NPTF, SAE/ORB threads. Other threads available upon request.

• Materials

	CARBON STEEL	STAINLESS STEEL	BRASS
Body	Carbon Steel EN-10277-3	AISI 316	Brass CuZn39Pb3
Seals	NBR, Viton or EPDM	NBR, Viton or EPDM	NBR, Viton or EPDM
Back-up-ring	PTFE	PTFE	PTFE
Balls	AISI 1010/1015	AISI316 W. 14401	AISI316 W. 14401
Springs	Carbon Steel DIN 17233/84(B)	AISI302 DIN 17224	AISI302 DIN 17224

• Working temperature (Seals)

	NBR	Viton	EPDM
	+100°C	+200°C	+150°C
	-30°C	-10°C	-40°C

• Sectors

Carbon Steel → Industrial.

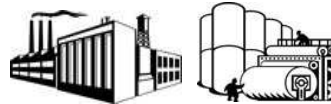

Stainless Steel → Chemical, Industrial, Offshore.



• **Applications:** Designed for Oil hydraulic Applications according to European Directive 97.23.EC

• Equivalence

FASTER H AEROQUIP FD45
PARKER 60 SNAP-TITE 72

MODEL STRUCTURE

Example;

103.22112BC

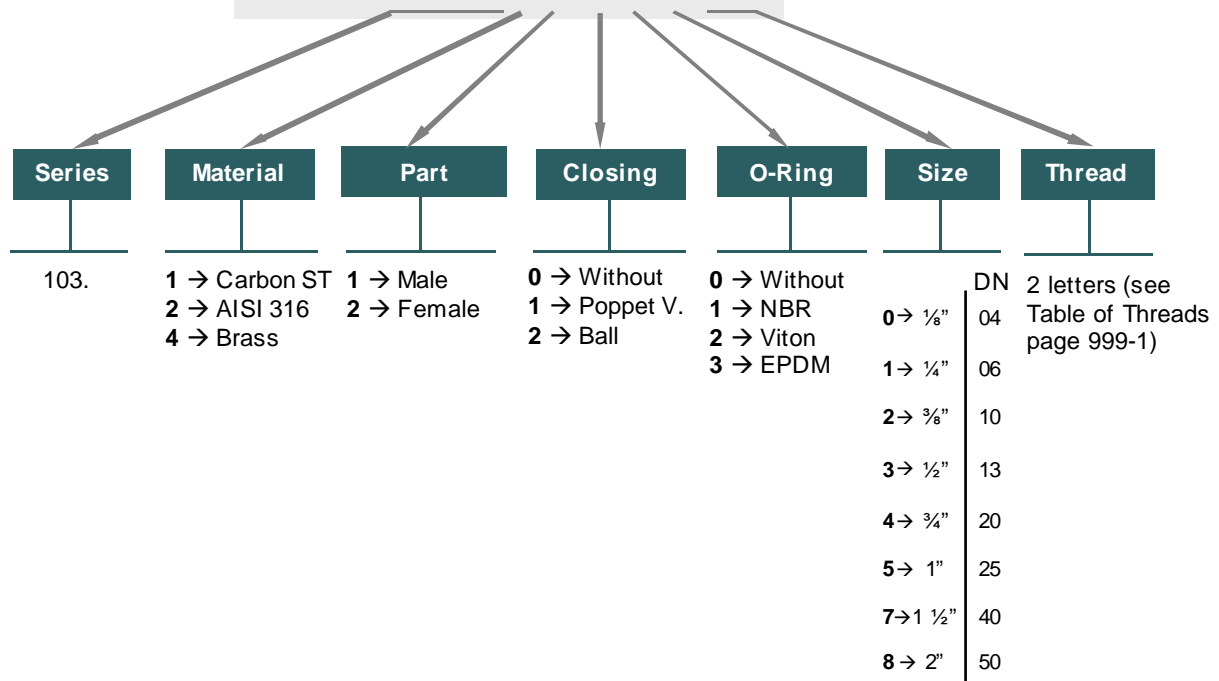

103-1





103 SERIES

ISO-B

CARBON STEEL /
AISI 316

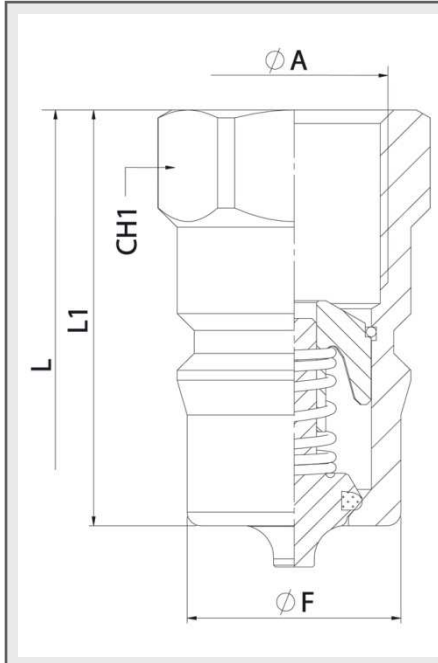

MALE				
DN	CH1	L1	ØF	L
04	14	30	10,90	60
06	19	36	14,20	72
10	24	40,50	19,10	81
13	27	46	23,55	92
20	36	56	31,45	112
25	41	63	37,80	126

STANDARD CARBON STEEL MODELS				
DN	ØA	MALE	FEMALE	
04	1/8" BSP	103.11110AA	103.12110AA	400Bar
	1/8" NPTF	103.11110BA	103.12110BA	
06	1/4" BSP	103.11111AB	103.12111AB	380Bar
	1/4" NPTF	103.11111BB	103.12111BB	
10	3/8" BSP	103.11112AC	103.12112AC	350Bar
	3/8" NPTF	103.11112BC	103.12112BC	
	3/4" - 16ORB	103.11112GF	103.12112GF	
13	1/2" BSP	103.11113AD	103.12113AD	320Bar
	1/2" NPTF	103.11113BD	103.12113BD	
	3/4" - 16ORB	103.11113GF	103.12113GF	
	7/8" 14ORB	103.11113GH	103.12113GH	
20	3/4" BSP	103.11114AE	103.12114AE	300Bar
	3/4" NPTF	103.11114BE	103.12114BE	
	1 1/16" - 12ORB	103.11114GK	103.12114GK	
25	1" BSP	103.11115AF	103.12115AF	280Bar
	1" NPTF	103.11115BF	103.12115BF	
	1 5/16" - 12ORB	103.11115GO	103.12115GO	

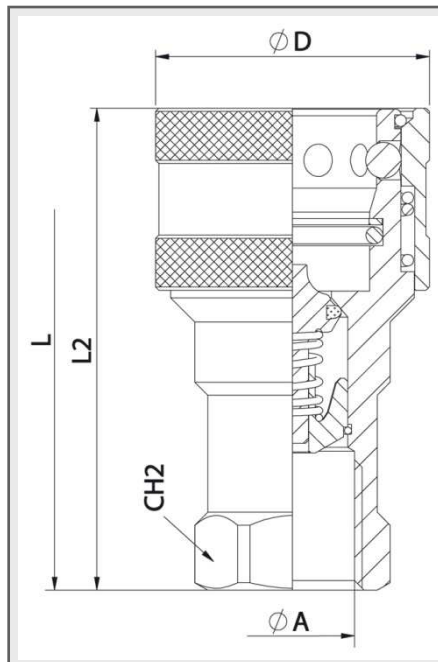

FEMALE				
DN	CH2	L2	ØD	L
04	14	49	22	60
06	19	57,70	27	72
10	24	65,50	35	81
13	27	74	42	92
20	36	90	52	112
25	41	103	60	126

STANDARD AISI 316 MODELS				
DN	ØA	MALE	FEMALE	
04	1/8" BSP	103.21120AA	103.22120AA	320Bar
	1/8" NPTF	103.21120BA	103.22120BA	
06	1/4" BSP	103.21121AB	103.22121AB	280Bar
	1/4" NPTF	103.21121BB	103.22121BB	
10	3/8" BSP	103.21122AC	103.22122AC	260Bar
	3/8" NPTF	103.21122BC	103.22122BC	
	3/4" - 16ORB	Upon request		
13	1/2" BSP	103.21123AD	103.22123AD	260Bar
	1/2" NPTF	103.21123BD	103.22123BD	
	3/4" - 16ORB	Upon request		
	7/8" 14ORB	Upon request		
20	3/4" BSP	103.21124AE	103.22124AE	210Bar
	3/4" NPTF	103.21124BE	103.22124BE	
	1 1/16" - 12ORB	Upon request		
25	1" BSP	103.21125AF	103.22125AF	210Bar
	1" NPTF	103.21125BF	103.22125BF	
	1 5/16" - 12ORB	Upon request		



103 SERIES

ISO-B CARBON STEEL



TECHNICAL DATA

DN	Rated Flow	Min Burst Pressure (bar)			Max. Working Pressure *
		Male	Female	Coupled	
04	7 l/m	1650	1750	1600	400 bar
06	15 l/m	1650	1800	1520	380 bar
10	35 l/m	1580	1580	1400	350 bar
13	47 l/m	1310	1450	1280	320 bar
20	93 l/m	1310	1380	1200	300 bar
25	118 l/m	1200	1400	1120	280 bar
40	480 l/m	550	560	560	140 bar
50	890 l/m	370	410	400	100 bar

* Safety factor 1:4
Data of Carbon Steel models

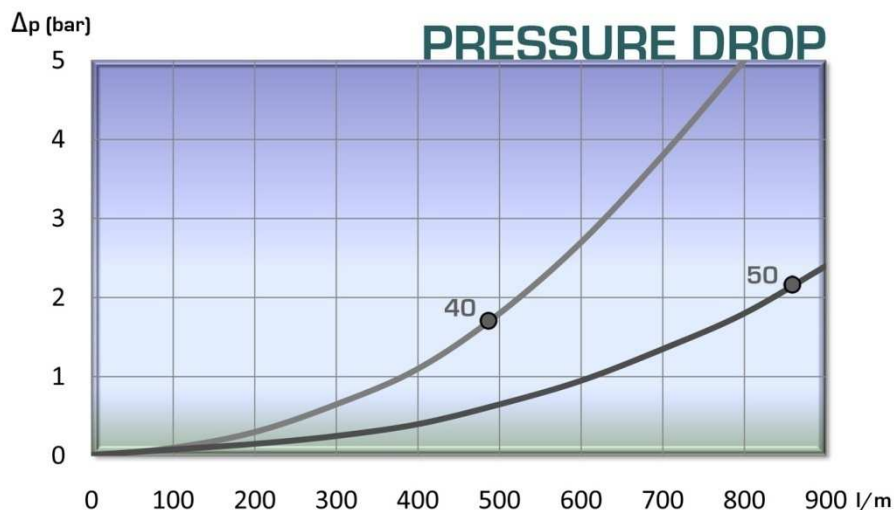
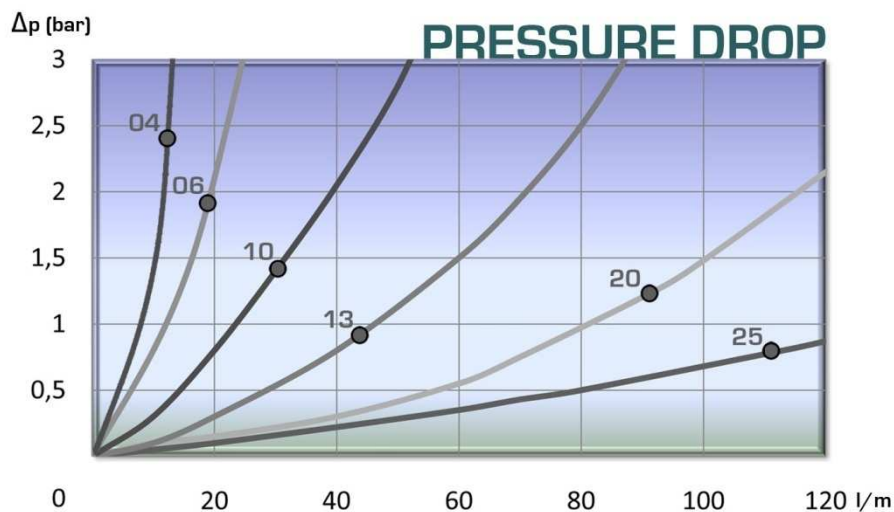

103-3





103 SERIES

ISO-B BRASS

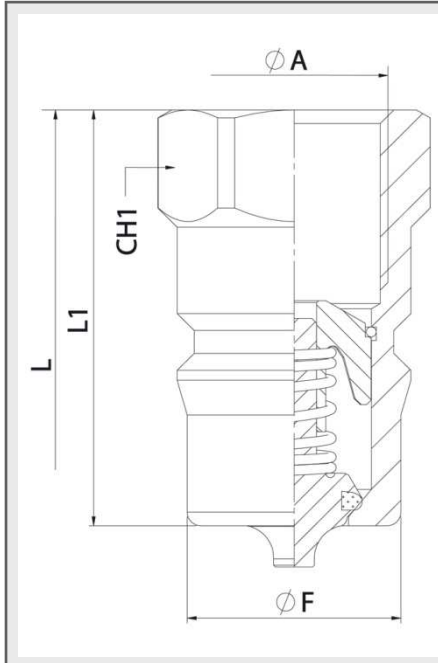

MALE				
DN	CH1	L1	ØF	L
04	14	30	10,90	60
06	19	36	14,20	72
10	24	40,50	19,10	81
13	27	46	23,55	92
20	36	56	31,45	112
25	41	63	37,80	126

STANDARD BRASS MODELS				
DN	ØA	MALE	FEMALE	
04	1/8" BSP	103.41120AA	103.42120AA	250Bar
	1/8" NPTF	103.41120BA	103.42120BA	
06	1/4" BSP	103.41121AB	103.42121AB	200Bar
	1/4" NPTF	103.41121BB	103.42121BB	
10	3/8" BSP	103.41122AC	103.42122AC	200Bar
	3/8" NPTF	103.41122BC	103.42122BC	
	3/4"-16ORB	Upon request		
	1/2" BSP	103.41123AD	103.42123AD	
13	1/2" NPTF	103.41123BD	103.42123BD	200Bar
	3/4" - 16ORB	Upon request		
	7/8" 14ORB	Upon request		
20	3/4" BSP	103.41124AE	103.42124AE	150Bar
	3/4" NPTF	103.41124BE	103.42124BE	
25	1 1/16"-12ORB	Upon request		150Bar
	1" BSP	103.41125AF	103.42125AF	
	1" NPTF	103.41125BF	103.42125BF	
	1 5/16"-12ORB	Upon request		

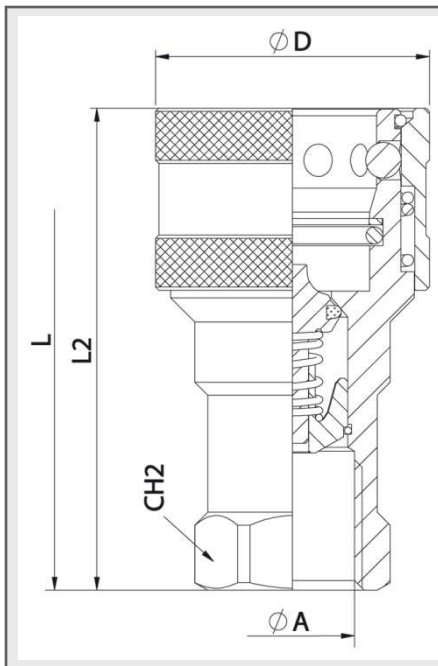

FEMALE				
DN	CH2	L2	ØD	L
04	14	49	22	60
06	19	57,70	27	72
10	24	65,50	35	81
13	27	74	42	92
20	36	90	52	112
25	41	103	60	126



103 SERIES

ISO-B PLUGS & CAPS





ISO B SERIES PLUGS/ CAPS have been designed to protect FEMALE (coupler) or MALE (nipple) parts while they are disconnected.
Manufactured according to ISO 7241-B norm

MODEL STRUCTURE

Example;

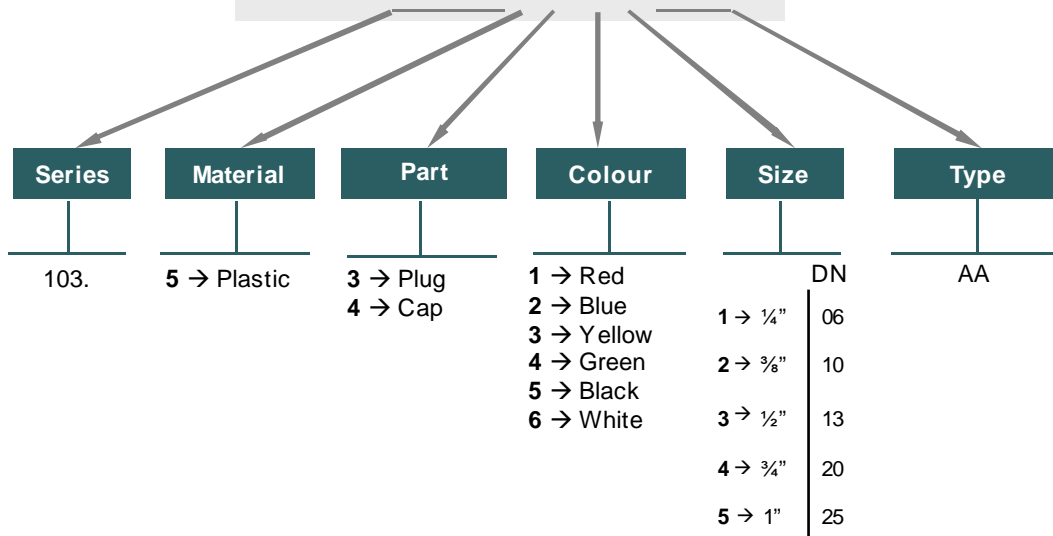
103.5321 AA





PLUG						
DN	RED	BLUE	YELLOW	GREEN	BLACK	WHITE
04	*	103.5320AA	*	*	*	*
06	*	103.5321AA	*	*	*	*
10	*	103.5322AA	*	*	*	*
13	*	103.5323AA	*	*	*	*
20	*	103.5324AA	*	*	*	*
25	*	103.5325AA	*	*	*	*

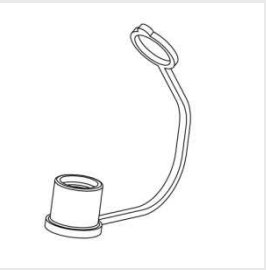

CAP						
DN	RED	BLUE	YELLOW	GREEN	BLACK	WHITE
04	*	103.5420AA	*	*	*	*
06	*	103.5421AA	*	*	*	*
10	*	103.5422AA	*	*	*	*
13	*	103.5423AA	*	*	*	*
20	*	103.5424AA	*	*	*	*
25	*	103.5425AA	*	*	*	*

* NOT AVAILABLE



103 SERIES

ISO-B

DN 40 / DN 50
SIZES

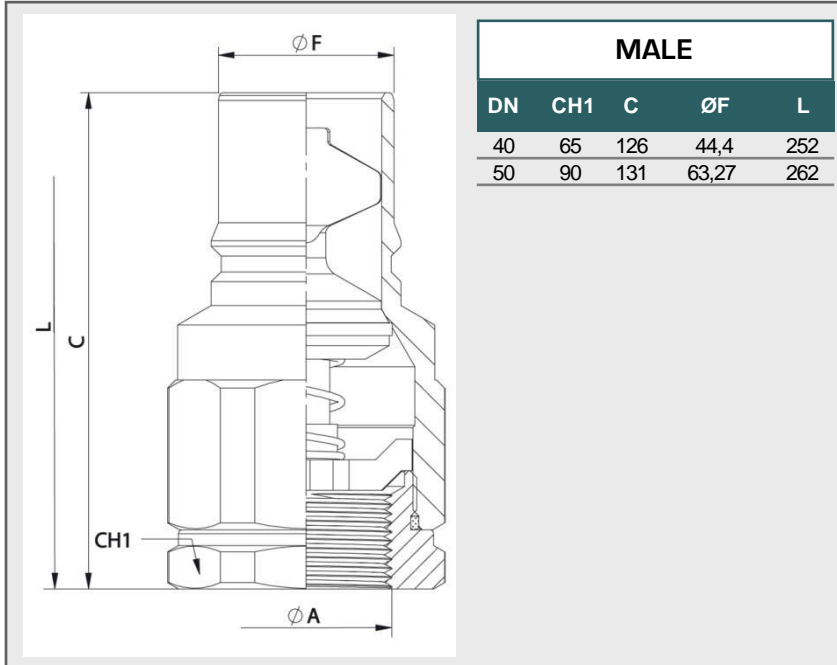

STANDARD CARBON STEEL MODELS			
DN	ØA	MALE	FEMALE
40	1 ¼" BSP	103.11117AG	103.12117AG
	1 ¼" NPTF	103.11117BG	103.12117BG
	1 ½" BSP	103.11117AH	103.12117AH
	1 ½" NPTF	103.11117BH	103.12117BH
	2" BSP	103.11118AI	103.12118AI
50	2" NPTF	103.11118BI	103.12118BI
	2 ½" BSP	103.11118AJ	103.12118AJ
	2 ½" NPTF	103.11118BJ	103.12118BJ
	3" BSP	103.11118AK	103.12118AK
	3" NPTF	103.11118BK	103.12118BK

STANDARD STAINLESS STEEL MODELS			
DN	ØA	MALE	FEMALE
40	1 ¼" BSP	103.21127AG	103.22127AG
	1 ¼" NPTF	103.21127BG	103.22127BG
	1 ½" BSP	103.21127AH	103.22127AH
	1 ½" NPTF	103.21127BH	103.22127BH
	2" BSP	103.21128AI	103.22128AI
50	2" NPTF	103.21128BI	103.22128BI
	2 ½" BSP	103.21128AJ	103.22128AJ
	2 ½" NPTF	103.21128BJ	103.22128BJ
	3" BSP	103.21128AK	103.22128AK
	3" NPTF	103.21128BK	103.22128BK

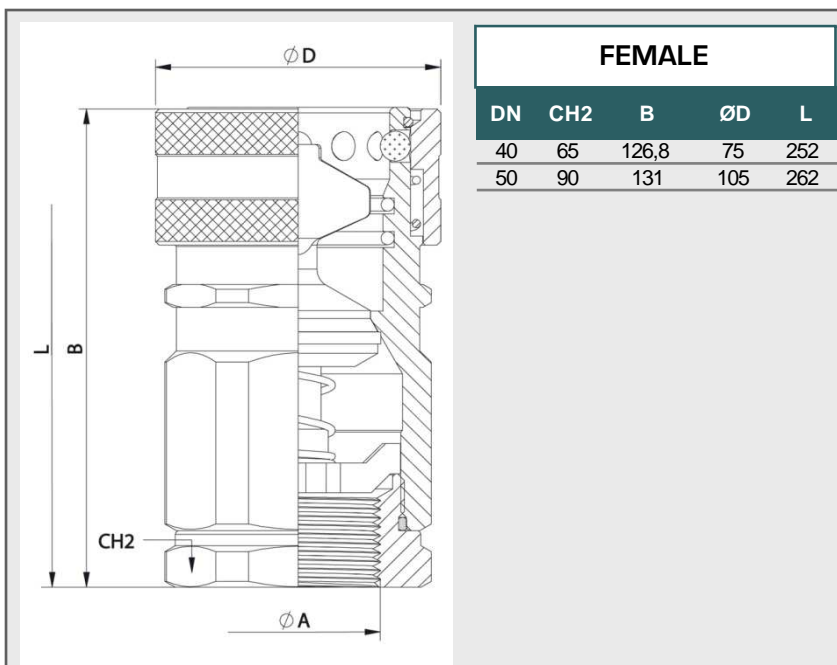

STANDARD BRASS MODELS			
DN	ØA	MALE	FEMALE
40	1 ¼" BSP	103.41127AG	103.42127AG
	1 ¼" NPTF	103.41127BG	103.42127BG
	1 ½" BSP	103.41127AH	103.42127AH
	1 ½" NPTF	103.41127BH	103.42127BH
	2" BSP	103.41128AI	103.42128AI
50	2" NPTF	103.41128BI	103.42128BI
	2 ½" BSP	103.41128AJ	103.42128AJ
	2 ½" NPTF	103.41128BJ	103.42128BJ
	3" BSP	103.41128AK	103.42128AK
	3" NPTF	103.41128BK	103.42128BK





103 SERIES

ISO-B PLUGS & CAPS



ISO B SERIES PLUGS/ CAPS have been designed to protect FEMALE (coupler) or MALE (nipple) parts while they are disconnected.
Manufactured according to ISO 7241-B norm.

MODEL STRUCTURE

Example;

103.6308 AA

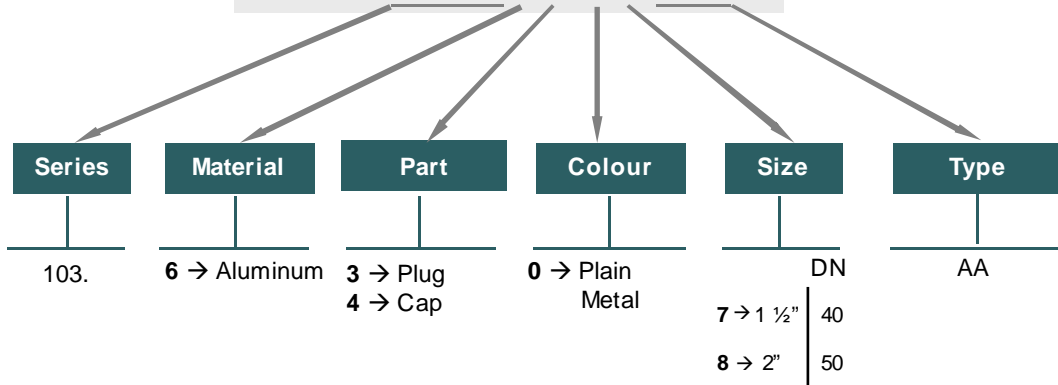

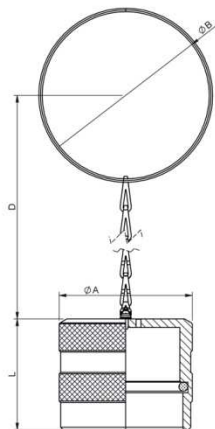

CAP					
DN	ØA	REF.	ØB	L	D
40	60	103.6407AA	70	60	609,5
50	78	103.6408AA	98	65	575,5

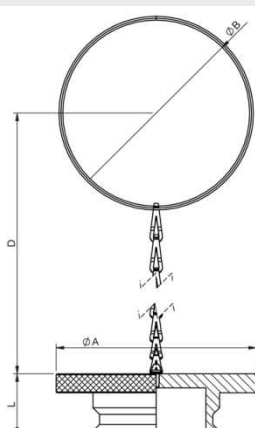

PLUG					
DN	ØA	REF.	ØB	L	D
40	75	103.6307AA	68	26	609,5
50	105	103.6308AA	98	32,4	575,5



104 SERIES DIN



Manufactured according to ISO 5675 norm, DN13 size meets also ISO 7241-A requirements.
 Poppet Valve or Ball closing system.
 BSP, NPTF, SAE/ORB threads. Others available upon request.

• Materials

Body: Carbon Steel EN-10277-3, AISI 303 / AISI 316 / BRASS DIN EN-12164

Seals: NBR, Viton or EPDM

Back-Up-Ring: PTFE

Balls: AISI 1010/1015

Springs: Carbon Steel
 DIN 17233/84(B)

• Working temperature (Seals)

	NBR	Viton	EPDM
+	+100°C	+200°C	+150°C
-	-30°C	-10°C	-40°C

• **Applications:** Designed for Oil hydraulic Applications according to European Directive 97.23.EC

• Equivalence

FASTER NV-NS
 AEROQUIP FD76
 PARKER 4000
 SNAP-TITE 60

• **Sectors:** Industrial, Agricultural



MODEL STRUCTURE

Example;

104.11122 AC

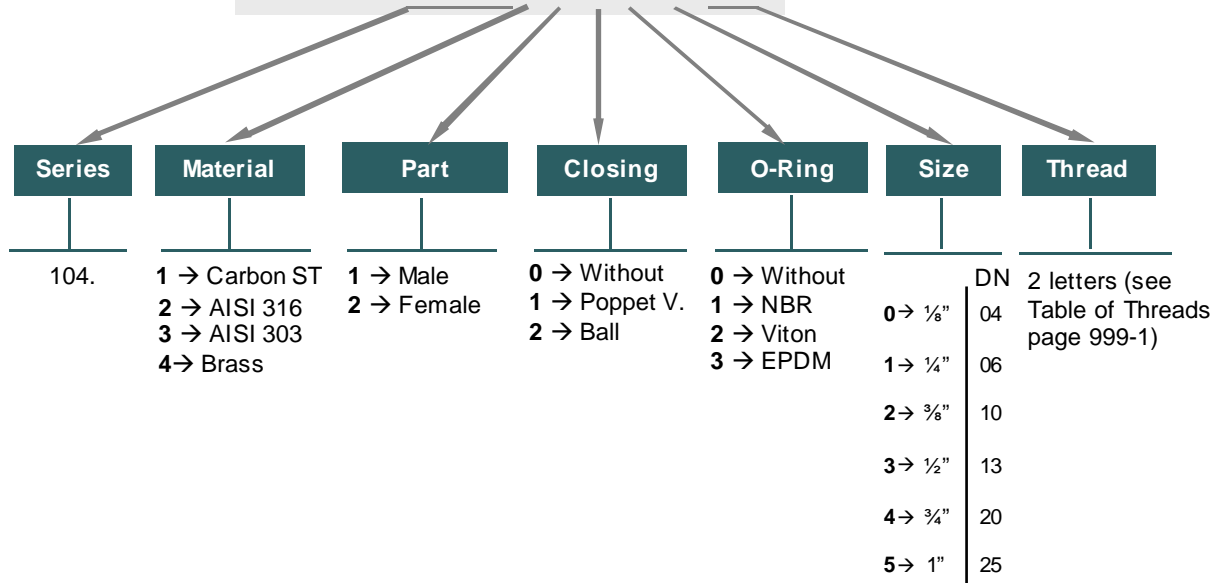

104-1



104 SERIES DIN

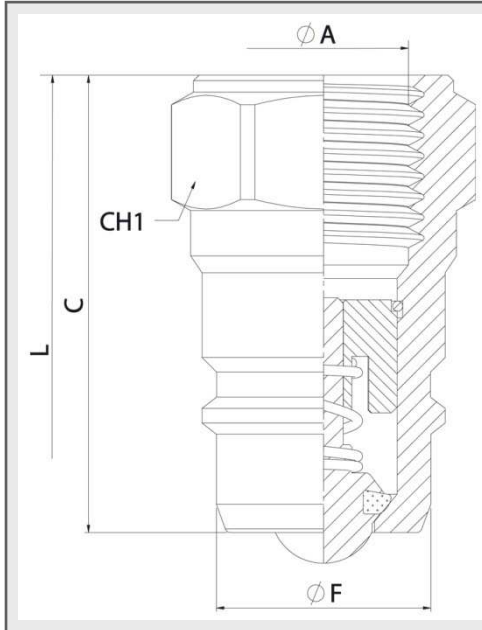

MALE				
DN	CH1	C	ØF	L
06	19	36	14,20	72
10	24	40,50	18,95	81
13	27	46	20,56	87,50
	30	50		91,50
20	36	56	27,95	112
25	41	63	31,30	126

STANDARD MODELS (POPPET)				
DN	ØA	MALE	FEMALE	
06	1/4" BSP	104.11111AB	104.12111AB	350Bar
	1/4" NPTF	104.11111BB	104.12111BB	
	9/16" 18ORB	104.11111GC	104.12111GC	
10	3/8" BSP	104.11112AC	104.12112AC	300Bar
	3/8" NPTF	104.11112BC	104.12112BC	
13	1/2" BSP	101.11113AD	101.12113AD	300Bar
	1/2" NPTF	101.11113BD	101.12113BD	
	3/4" - 16ORB	101.11113GF	101.12113GF	
20	7/8" - 14ORB	101.11113GH	101.12113GH	250Bar
	3/4" BSP	104.11114AE	104.12114AE	
25	3/4" NPTF	104.11114BE	104.12114BE	220Bar
	1" BSP	104.11115AF	104.12115AF	
	1" NPTF	104.11115BF	104.12115BF	

Manufactured according to ISO 5675 norm

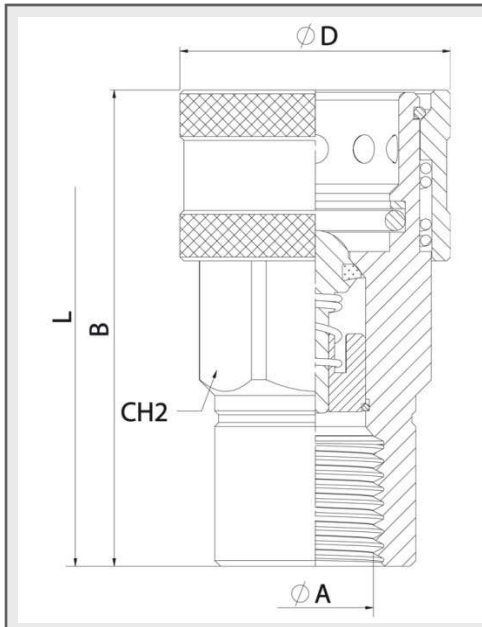

FEMALE				
DN	CH2	B	ØD	L
06	22	53,50	27	72
10	27	61	35	81
13	30	63,50	38	89,50
				91,50
20	38	85	48	112
25	46	96,50	55	126

STANDARD MODELS (BALL)				
DN	ØA	MALE	FEMALE	
06	1/4" BSP	104.11211AB	104.12211AB	350Bar
	1/4" NPTF	104.11211BB	104.12211BB	
	9/16" 18ORB	104.11211GC	104.12211GC	
10	3/8" BSP	104.11212AC	104.12212AC	300Bar
	3/8" NPTF	104.11212BC	104.12212BC	
13	1/2" BSP	101.11213AD	101.12213AD	300Bar
	1/2" NPTF	101.11213BD	101.12213BD	
	3/4" - 16ORB	101.11213GF	101.12213GF	
20	7/8" - 14ORB	101.11213GH	101.12213GH	250Bar
	3/4" BSP	104.11214AE	104.12214AE	
25	3/4" NPTF	104.11214BE	104.12214BE	220Bar
	1" BSP	104.11215AF	104.12215AF	
	1" NPTF	104.11215BF	104.12215BF	

Manufactured according to ISO 5675 norm



104 SERIES DIN



TECHNICAL DATA

DN	Rated Flow	Min Burst Pressure (bar)			Max. Working Pressure *
		Male	Female	Coupled	
06	15 l/m	1650	1800	1400	350 bar
10	35 l/m	1250	1350	1200	300 bar
13	45 l/m	1200	1300	1200	300 bar
20	74 l/m	1030	1200	1000	250 bar
25	100 l/m	950	980	920	220 bar

* Safety factor 1:4
Data of Carbon Steel models

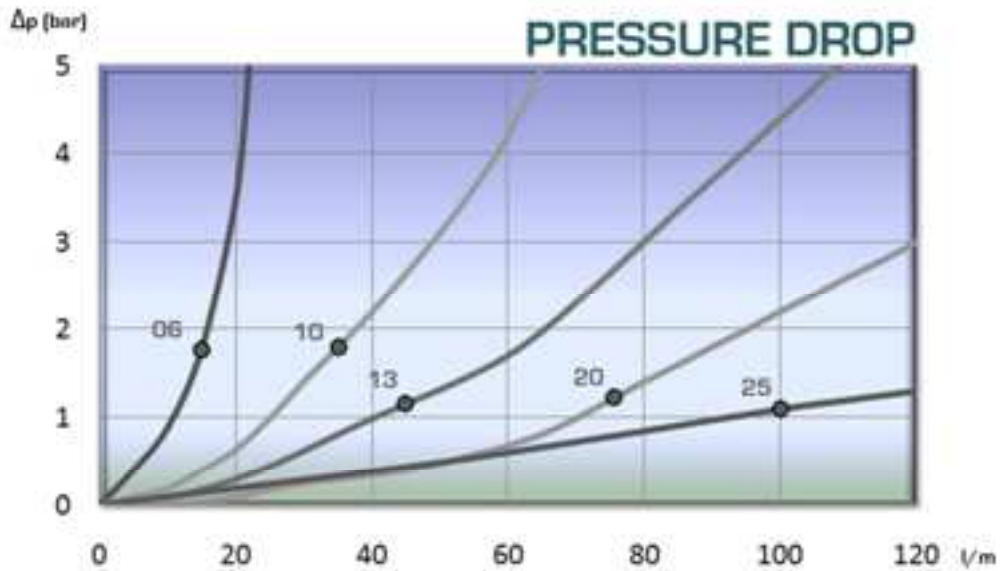

104-3





104 SERIES

DIN

PLUGS &
CAPS





DIN SERIES PLUGS/ CAPS have been designed to protect FEMALE (coupler) or MALE (nipple) parts while they are disconnected.
They have been manufactured according to ISO 5675 norm, DN13 size meets also ISO7241-A requirements

MODEL STRUCTURE For plugs and caps

Example;

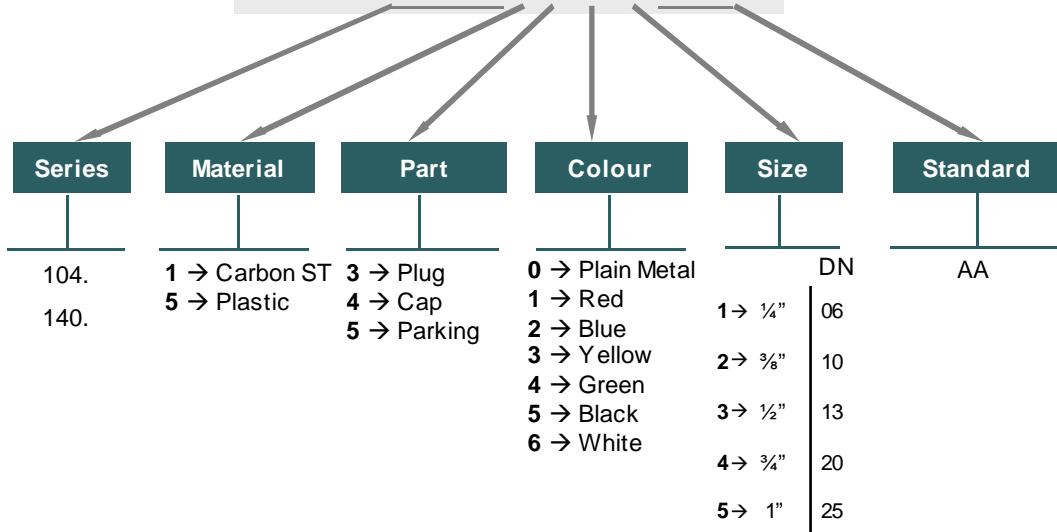
104.5353 AA





PLUG						
DN	RED	BLUE	YELLOW	GREEN	BLACK	WHITE
06	*	*	*	*	104.5351AA	*
10	*	*	*	*	104.5352AA	*
13	*	*	*	*	101.5353AA	*
20	*	*	*	*	104.5354AA	*
25	*	*	*	*	104.5355AA	*

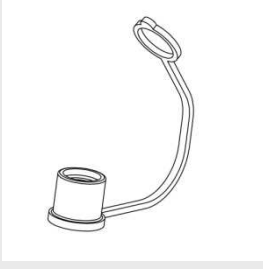

CAP						
DN	RED	BLUE	YELLOW	GREEN	BLACK	WHITE
06	*	*	*	*	104.5451AA	*
10	*	*	*	*	104.5452AA	*
13	*	*	*	*	101.5453AA	*
20	*	*	*	*	104.5454AA	*
25	*	*	*	*	104.5455AA	*

* NOT AVAILABLE





104 SERIES

DIN PARKINGS



PARKING 3B			
DN	REF.	ØA	L
13	101.1533AA	32	34

PARKING 1T			
DN	REF.	ØA	L
13	101.1533AC	30	38

PARKING 6B			
DN	REF.	ØA	L
13	101.1533AB	34	38



105 SERIES PSH



Manufactured according to ISO 7241-A and ISO 5675 norms.
 Poppet Valve or Ball closing system.
 BSP, NPTF, SAE/ORB threads. Other threads available upon request.

• Materials

Carbon Steel EN -10277-3
 Seals: NBR, Viton or EPDM
 Back-Up-Ring: PTFE
 Balls: AISI 1010/1015
 Springs: Carbon Steel
 DIN 17233/84(B)

• Working temperature (Seals)

	NBR o-rings	Viton o-rings	EPDM o-rings
+	+100°C	+200°C	+150°C
-	-30°C	-10°C	-40°C

• **Applications:** Designed for Oil hydraulic Applications according to European Directive 97.23.EC

• **Sectors:** Industrial, Agricultural

• Equivalence

FASTER PV / CPV
 ARGUS SVK
 PARKER 4200



MODEL STRUCTURE

Example;

105.11113BD

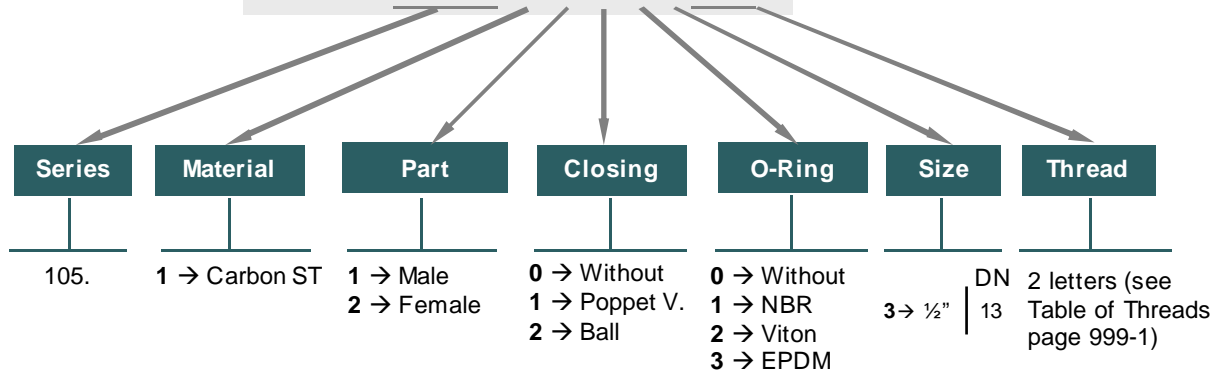

105-1





105 SERIES PSH

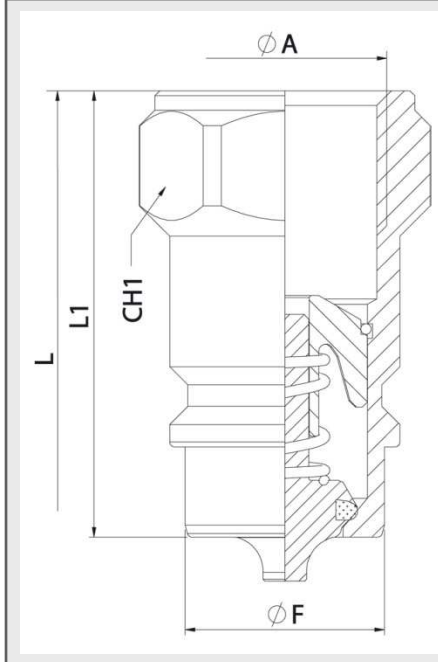

MALE				
DN	CH1	L1	ØF	L
13	27	46	20,56	87,50
		48		89,50
	30	50	91,50	

STANDARD MALE MODELS			
DN	ØA	MALE	
13	1/2" BSP	101.11113AD	300Bar
	1/2" NPTF	101.11113BD	
	M22x1,5	101.11113NG	
	3/4" - 16ORB	101.11113GF	
	7/8" 14ORB	101.11113GH	

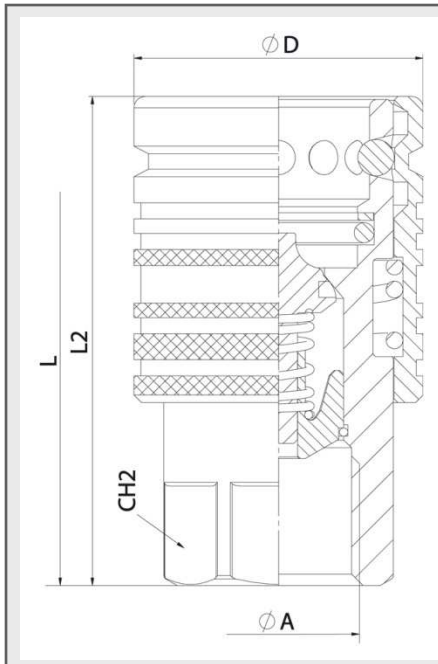

FEMALE				
DN	CH2	L2	ØD	L
13	27	63,50	37,80	87,50

STANDARD FEMALE MODELS			
DN	ØA	FEMALE	
13	1/2" BSP	105.12113AD	300Bar
	1/2" NPTF	105.12113BD	
	M22x1,5	105.12113NG	



105 SERIES

PSH

PLUGS &
CAPS





PSH SERIES PLUGS/ CAPS have been designed to protect FEMALE (coupler) or MALE (nipple) parts while they are disconnected.

Manufactured according to ISO 7241-A norm, DN13 size meets as well ISO 5675 requirements.

MODEL STRUCTURE

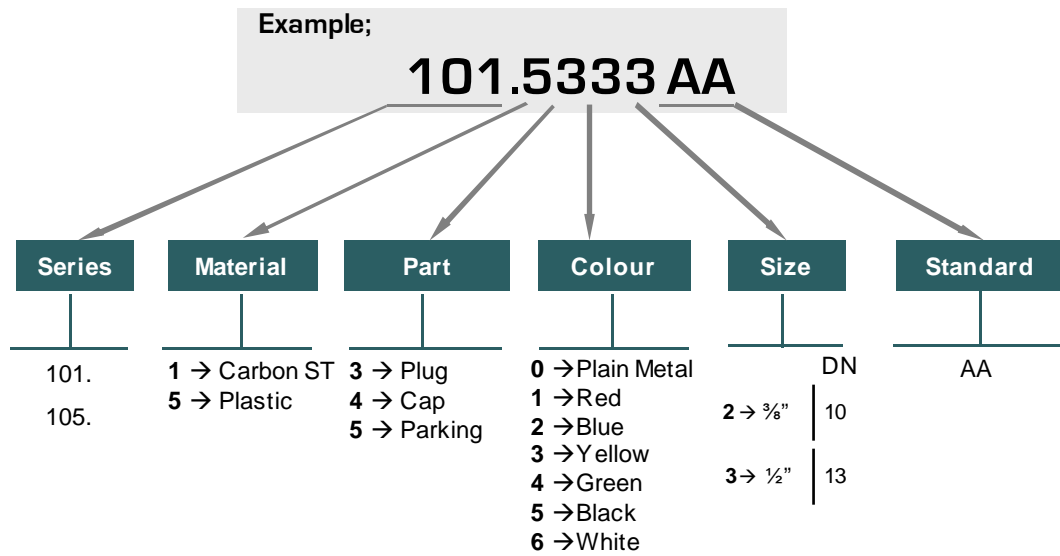
For plugs/caps and parking parts





PLUG						
DN	RED	BLUE	YELLOW	GREEN	BLACK	WHITE
10	101.5312AA	101.5322AA	101.5332AA	101.5342AA	101.5352AA	101.5362AA
13	101.5313AA	101.5323AA	101.5333AA	101.5343AA	101.5353AA	101.5363AA

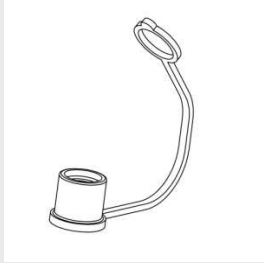

CAP						
DN	RED	BLUE	YELLOW	GREEN	BLACK	WHITE
10	101.5412AA	101.5422AA	101.5432AA	101.5442AA	101.5452AA	101.5462AA
13	101.5413AA	101.5423AA	101.5433AA	101.5443AA	101.5453AA	101.5463AA



105 SERIES

PSH PARKINGS



	<p>PARKING 3B</p> <table border="1"> <thead> <tr> <th>DN</th> <th>REF.</th> <th>ØA</th> <th>L</th> </tr> </thead> <tbody> <tr> <td>13</td> <td>101.1563AA</td> <td>32</td> <td>34</td> </tr> </tbody> </table>	DN	REF.	ØA	L	13	101.1563AA	32	34
DN	REF.	ØA	L						
13	101.1563AA	32	34						
	<p>PARKING 1T</p> <table border="1"> <thead> <tr> <th>DN</th> <th>REF.</th> <th>ØA</th> <th>L</th> </tr> </thead> <tbody> <tr> <td>13</td> <td>101.1563AC</td> <td>30</td> <td>38</td> </tr> </tbody> </table>	DN	REF.	ØA	L	13	101.1563AC	30	38
DN	REF.	ØA	L						
13	101.1563AC	30	38						
	<p>PARKING 6B</p> <table border="1"> <thead> <tr> <th>DN</th> <th>REF.</th> <th>ØA</th> <th>L</th> </tr> </thead> <tbody> <tr> <td>13</td> <td>101.1563AA</td> <td>34</td> <td>38</td> </tr> </tbody> </table>	DN	REF.	ØA	L	13	101.1563AA	34	38
DN	REF.	ØA	L						
13	101.1563AA	34	38						
	<p>PARKING PSH</p> <table border="1"> <thead> <tr> <th>DN</th> <th>REF.</th> <th>ØA</th> <th>L</th> </tr> </thead> <tbody> <tr> <td>13</td> <td>105.1563AB</td> <td>37,80</td> <td>40</td> </tr> </tbody> </table>	DN	REF.	ØA	L	13	105.1563AB	37,80	40
DN	REF.	ØA	L						
13	105.1563AB	37,80	40						



106 SERIES DIA



Manufactured according to ISO 5675 norm.
 Special product for American market.
 Poppet Valve or Ball closing system.
 BSP, NPTF, SAE/ORB threads. Other threads available upon request.

• Materials

Carbon Steel EN -10277-3
 Seals: NBR, Viton or EPDM
 Back-Up-Ring: PTFE
 Balls: AISI 1010/1015
 Springs: Carbon Steel
 DIN 17233/84(B)

• Working temperature (Seals)

	NBR	Viton	EPDM
+	+100°C	+200°C	+150°C
-	-30°C	-10°C	-40°C

• **Applications:** Designed for Oil hydraulic Applications according to European Directive 97.23.EC
 Special for American market

• **Sectors:** Industrial, Agricultural



• Equivalence

FASTER NV-NS
 AEROQUIP FD76
 PARKER 4000
 SNAP-TITE 60

MODEL STRUCTURE

Example;

106.11114 BE

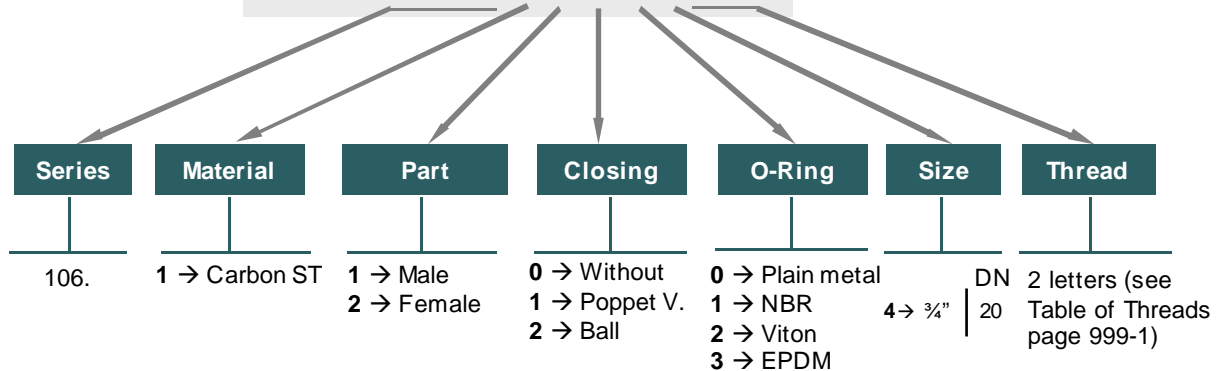



106 SERIES DIA

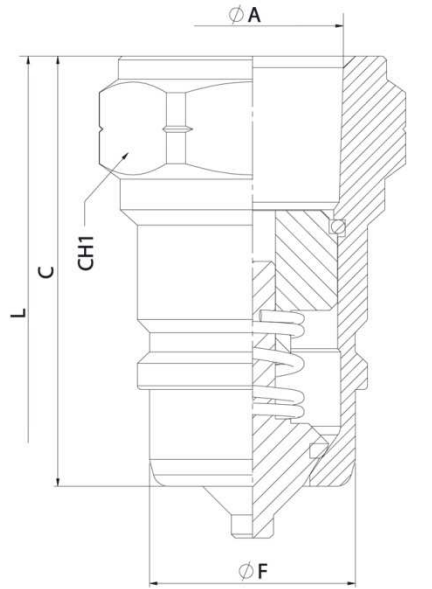

STANDARD MALE MODEL

DN	ØA	REF.		CH1	C	ØD	L
20	¾" NPTF	106.11114BE	250Bar	36	56	26,85	112
20	¾" NPTF	106.11214BE*	250Bar	36	56	26,85	112

* Ball Valve Style

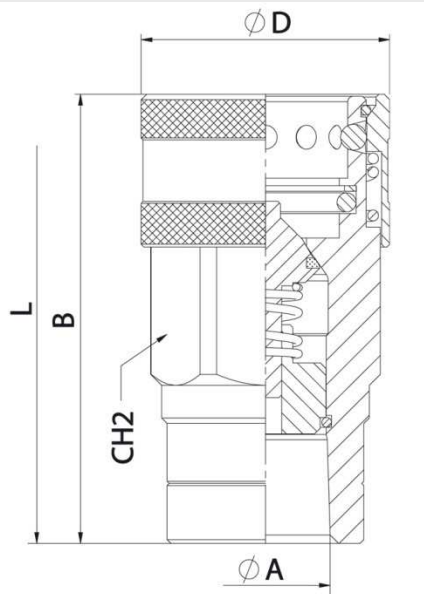

STANDARD FEMALE MODEL

DN	ØA	REF.		CH2	B	ØF	L
20	¾" NPTF	106.12114BE	250Bar	38	82	45,50	112
20	¾" NPTF	106.12214BE*	250Bar	38	82	45,50	112

* Ball Valve Style



107 SERIES PSM

DIN2353 Threads
DIN2353 Bulkhead
DIN3852 BSP/NPTF/ORB

Manufactured according to ISO 7241-A and ISO 5675 norms.
Poppet Valve or Ball closing system.
DIN2353 threads. Other threads available upon request.

• Materials

Carbon Steel EN -10277-3
Seals: NBR
Back-Up-Ring: PTFE
Balls: AISI 1010/1015
Springs: Carbon Steel
DIN 17233/84(B)

• **Applications:** Designed for Oil hydraulic Applications according to European Directive 97.23.EC

• Equivalence

FASTER PV 9 CPV
ARGUS SVK
PARKER 4200

• Working temperature (Seals)

	NBR	Viton	EPDM
+	+100°C	+200°C	+150°C
-	-30°C	-10°C	-40°C

• **Sectors:** Industrial, Agricultural



MODEL STRUCTURE

Example;

107.12113KF

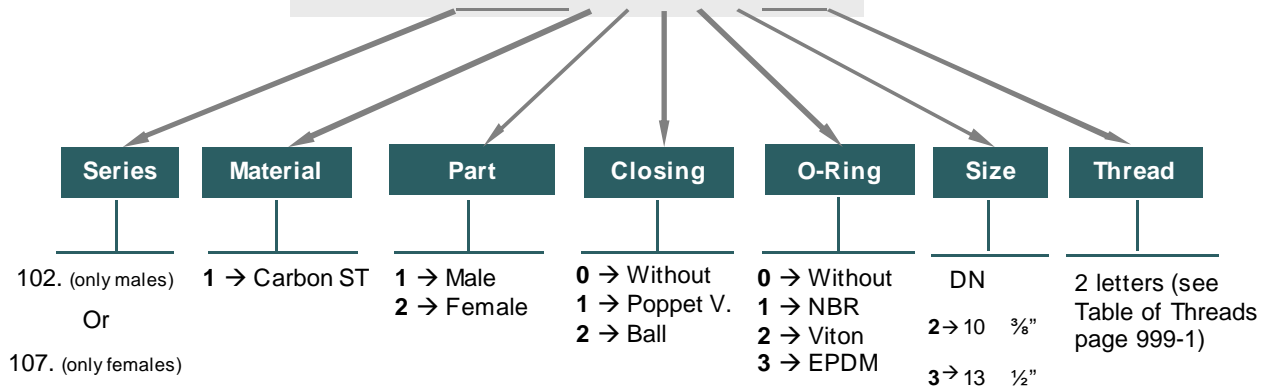

107-1



107 SERIES

PSM

DIN2353
Threads

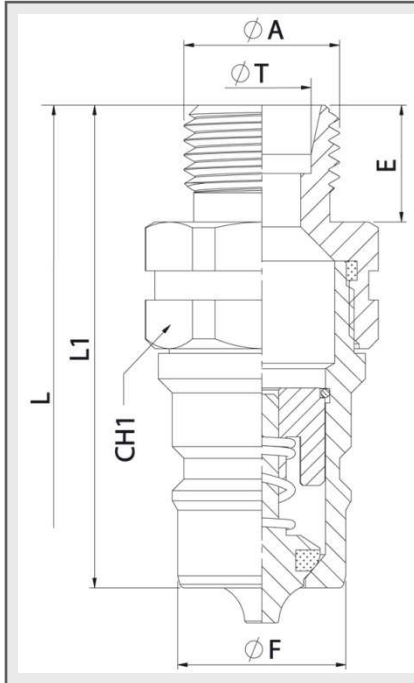

MALE					
DN	CH1	L1	ØF	L	E
10	22	49,57	17,30	97,07	12
13	27 30	56 79	20,56	105,80 151,80	12 35

* DN10 MALE drawing

STANDARD MALE MODELS

DN	ØA	ØT	REF.	
10	M12x1,5	6L	102.11112JB	270Bar
	M14x1,5	8L	102.11112JC	
	M16x1,5	10L	102.11112JD	
	M18x1,5	12L	102.11112JE	
	M16x1,5	8S	102.11112KD	
	M18x1,5	10S	102.11112KE	
	M20x1,5	12S	102.11112KF	
13	3/8" BSP	-	102.11112AN	250Bar
	M14x1,5	8L	102.11113JC	
	M16x1,5	10L	102.11113JD	
	M18x1,5	12L	102.11113JE	
	M22x1,5	15L	102.11113JG	
	M26x1,5	18L	102.11113JI	
	M18x1,5	10S	102.11113KE	
	M20x1,5	12S	102.11113KF	
	M22x1,5	14S	102.11113KG	
	M24x1,5	16S	102.11113KH	
M30x2	20S	102.11113KJ		

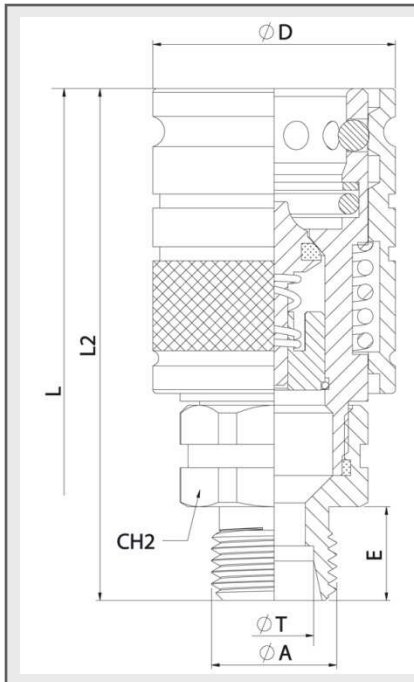

FEMALE					
DN	CH2	L2	ØD	L	E
10	22	65,50	31	97,07	12
13	27 30	71,80 94,80	37,80	105,80 151,80	12 35

* DN10 FEMALE drawing

STANDARD FEMALE MODELS

DN	ØA	ØT	REF.	
10	M12x1,5	6L	107.12112JB	270Bar
	M14x1,5	8L	107.12112JC	
	M16x1,5	10L	107.12112JD	
	M18x1,5	12L	107.12112JE	
	M16x1,5	8S	107.12112KD	
	M18x1,5	10S	107.12112KE	
	M20x1,5	12S	107.12112KF	
13	3/8" BSP	-	107.12112AN	250Bar
	M14x1,5	8L	107.12113JC	
	M16x1,5	10L	107.12113JD	
	M18x1,5	12L	107.12113JE	
	M22x1,5	15L	107.12113JG	
	M26x1,5	18L	107.12113JI	
	M18x1,5	10S	107.12113KE	
	M20x1,5	12S	107.12113KF	
	M22x1,5	14S	107.12113KG	
	M24x1,5	16S	107.12113KH	
M30x2	20S	107.12113KJ		

107 SERIES

PSM

DIN2353
Bulkhead



MALE					
DN	CH1	CH2	L1	ØD	L
10	22	19	71,57	17,30	141,07
		22			
		24			
		24			
13	27	19	78	20,56	149,80
		30	79		151,80
		24	68		129,80
		27	79		151,80
		30	56		105,80
		24	68		129,80
		27	79		151,80
		27	79		151,80
		30	79		151,80
		30	36		79

* DN13 MALE drawing

STANDARD MALE MODELS			
DN	ØA	ØT	REF.
10	M12x1,5	6L	102.11112LB
	M14x1,5	8L	102.11112LC
	M16x1,5	10L	102.11112LD
	M18x1,5	12L	102.11112LE
	M16x1,5	8S	102.11112MD
	M18x1,5	10S	102.11112ME
13	M20x1,5	12S	102.11112MF
	M14x1,5	8L	102.11113LC
	M16x1,5	10L	102.11113LD
	M18x1,5	12L	102.11113LE
	M22x1,5	15L	102.11113LG
	M26x1,5	18L	102.11113LJ
	M18x1,5	10S	102.11113ME
	M20x1,5	12S	102.11113MF
	M22x1,5	14S	102.11113MG
	M24x1,5	16S	102.11113MH
M30x2	20S	102.11113MJ	

FEMALE					
DN	CH2	CH3	L2	ØD	L
10	22	19	87,5	31	141,07
		22			
		24			
		24			
13	27	19	78	37,80	149,80
		30	79		151,80
		24	68		129,80
		27	79		151,80
		30	56		105,80
		24	68		129,80
		27	79		151,80
		27	79		151,80
		30	79		151,80
		30	36		79

* DN13 FEMALE drawing

STANDARD FEMALE MODELS			
DN	ØA	ØT	REF.
10	M12x1,5	6L	107.12112LB
	M14x1,5	8L	107.12112LC
	M16x1,5	10L	107.12112LD
	M18x1,5	12L	107.12112LE
	M16x1,5	8S	107.12112MD
	M18x1,5	10S	107.12112ME
13	M20x1,5	12S	107.12112MF
	M14x1,5	8L	107.12113LC
	M16x1,5	10L	107.12113LD
	M18x1,5	12L	107.12113LE
	M22x1,5	15L	107.12113LG
	M26x1,5	18L	107.12113LJ
	M18x1,5	10S	107.12113ME
	M20x1,5	12S	107.12113MF
	M22x1,5	14S	107.12113MG
	M24x1,5	16S	107.12113MH
M30x2	20S	107.12113MJ	



107 SERIES

PSM

DIN 3852
BSP/NPTF/ORB

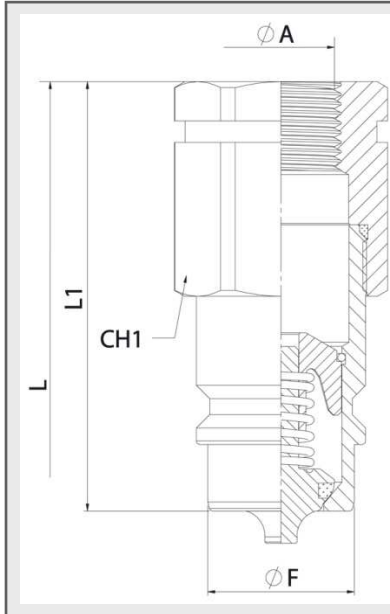

MALE					
DN	ØA	CH1	L1	ØF	L
10	1/4" BSP	22	50,57	17,30	99,07
	1/4" NPTF	22			
	3/8" BSP	22			
	3/8" NPTF	22			
	M16x1,5	22			
	M18x1,5	22			
13	3/8" BSP	27	20,56		113,80
	1/2" BSP	27			
	3/4" NPTF	30			
	M14x1,5	27			
	M16x1,5	27			
	M18,1,5	27			
	M22x1,5	27			
	3/4" -16ORB	27			
	7/8" -14ORB	27			
	* 3/4" -16ORB	27			

* DN13 MALE drawing

STANDARD MALE MODELS

DN	ØA	REF.	
10	1/4" BSP	102.11112AB	270Bar
	1/4" NPTF	102.11112BB	
	3/8" BSP	102.11112AC	
	3/8" NPTF	102.11112BC	
	M16x1,5	102.11112ND	
	M18x1,5	102.11112NE	
13	3/8" BSP	102.11113AC	250Bar
	1/2" BSP	102.11113AD	
	3/4" NPTF	102.11113BE	
	M14x1,5	102.11113NC	
	M16x1,5	102.11113ND	
	M18x1,5	102.11113NE	
	M22x1,5	102.11113NG	
	3/4" -16ORB	102.11113GF	
7/8" -14ORB	102.11113GH		
* 3/4" -16ORB	102.11113GFA		

* This reference is habitually provided in the Spanish market, being the head cylindrical instead of 27mm hexagonal

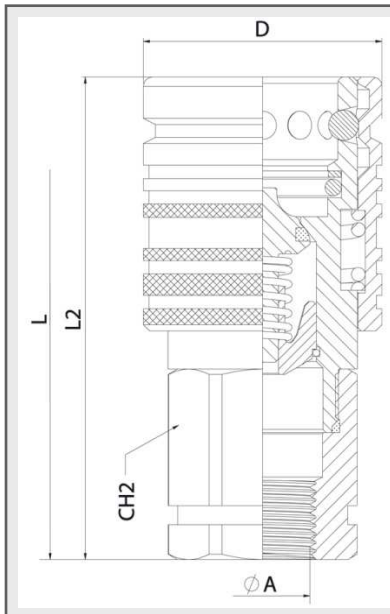

FEMALE					
DN	ØA	CH2	L2	ØD	L
10	1/4" BSP	22	66,5	31	99,07
	1/4" NPTF	22			
	3/8" BSP	22			
	3/8" NPTF	22			
	M16x1,5	22			
	M18x1,5	22			
13	3/8" BSP	27	37,80		113,80
	1/2" BSP	27			
	3/4" NPTF	30			
	M14x1,5	27			
	M16x1,5	27			
	M18,1,5	27			
	M22x1,5	27			
	3/4" -16ORB	27			
	7/8" -14ORB	27			
	* 3/4" -16ORB	27			

* DN13 FEMALE drawing

STANDARD FEMALE MODELS

DN	ØA	REF.	
10	1/4" BSP	107.12112AB	270Bar
	1/4" NPTF	107.12112BB	
	3/8" BSP	107.12112AC	
	3/8" NPTF	107.12112BC	
	M16x1,5	107.12112ND	
	M18x1,5	107.12112NE	
13	3/8" BSP	107.12113AC	250Bar
	1/2" BSP	107.12113AD	
	3/4" NPTF	107.12113BE	
	M14x1,5	107.12113NC	
	M16x1,5	107.12113ND	
	M18,1,5	107.12113NE	
	M22x1,5	107.12113NG	
	3/4" -16ORB	107.12113GF	
7/8" -14ORB	107.12113GH		
* 3/4" -16ORB	107.12113GFA		

* This reference is habitually provided in the Spanish market, being the head cylindrical instead of 27mm hexagonal



107 SERIES

PSM

PLUGS &
CAPS



PSM SERIES PLUGS/CAPS have been designed to protect FEMALE (coupler) or MALE (nipple) parts while they are disconnected.
Manufactured according to ISO 7241-A norm, DN13 size meets also ISO 5675 requirements.

MODEL STRUCTURE

For plugs/caps and parking parts

Example;

101.5313 AA

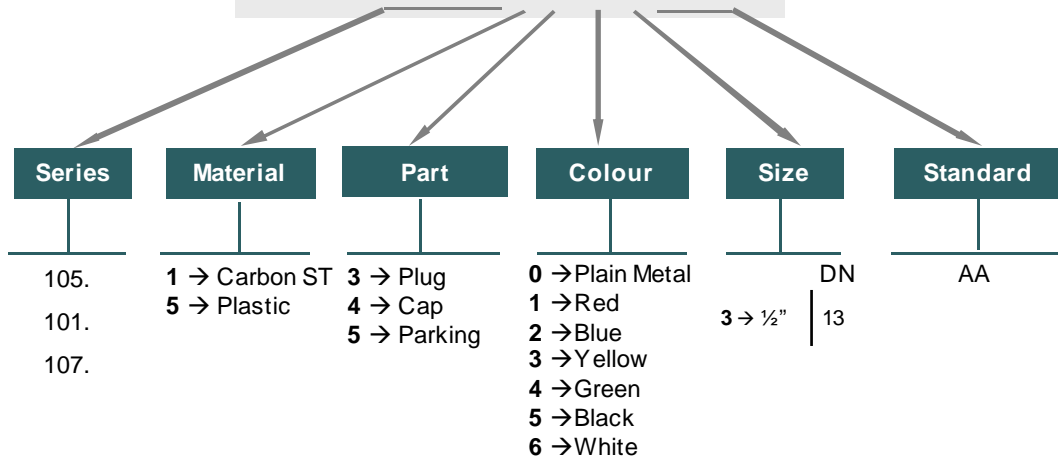



PLUG						
DN	RED	BLUE	YELLOW	GREEN	BLACK	WHITE
13	101.5313AA	*	*	*	*	*

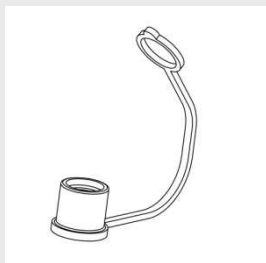

CAP						
DN	RED	BLUE	YELLOW	GREEN	BLACK	WHITE
13	101.5413AA	*	*	*	*	*



107 SERIES

PSM PARKING



PSM SERIES PARKINGS have been designed to protect FEMALE (coupler) or MALE (nipple) parts while they are disconnected. 4 TYPES available in 1/2", 3B, 1T, 6B and PSH.

	<p>PARKING 3B</p> <table border="1"> <thead> <tr> <th>DN</th> <th>REF.</th> <th>ØA</th> <th>L</th> </tr> </thead> <tbody> <tr> <td>13</td> <td>101.1533AA</td> <td>32</td> <td>34</td> </tr> </tbody> </table>	DN	REF.	ØA	L	13	101.1533AA	32	34
DN	REF.	ØA	L						
13	101.1533AA	32	34						
	<p>PARKING 1T</p> <table border="1"> <thead> <tr> <th>DN</th> <th>REF.</th> <th>ØA</th> <th>L</th> </tr> </thead> <tbody> <tr> <td>13</td> <td>101.1533AC</td> <td>38</td> <td>30</td> </tr> </tbody> </table>	DN	REF.	ØA	L	13	101.1533AC	38	30
DN	REF.	ØA	L						
13	101.1533AC	38	30						
	<p>PARKING 6B</p> <table border="1"> <thead> <tr> <th>DN</th> <th>REF.</th> <th>ØA</th> <th>L</th> </tr> </thead> <tbody> <tr> <td>13</td> <td>101.1533AB</td> <td>34</td> <td>38</td> </tr> </tbody> </table>	DN	REF.	ØA	L	13	101.1533AB	34	38
DN	REF.	ØA	L						
13	101.1533AB	34	38						
	<p>PARKING PSH</p> <table border="1"> <thead> <tr> <th>DN</th> <th>REF.</th> <th>ØA</th> <th>L</th> </tr> </thead> <tbody> <tr> <td>13</td> <td>105.1533AA</td> <td>37,50</td> <td>40</td> </tr> </tbody> </table>	DN	REF.	ØA	L	13	105.1533AA	37,50	40
DN	REF.	ØA	L						
13	105.1533AA	37,50	40						



120 SERIES

IFR

DIN 2353, DIN3852 / BSP
DIN 2353 SAE/ORB



Manufactured according ISO 5676 / ISO / TC23 / NFU 16006 norms.
BSP, DIN2353, DIN3852, SAE/ORB threads, other threads available upon request.

• Materials

Carbon Steel EN 10277-3
Seals: NBR, Viton or EPDM
Balls: AISI 316W 14401
Springs: Carbon Steel DIN 17233/84(B)

• Working temperature (Seals)

	NBR	Viton	EPDM
	+100°C	+200°C	+150°C
	-30°C	-10°C	-40°C

• **Applications:** Designed for Oil hydraulic Applications according to European Directive 97.23.EC

• **Sectors:** Agricultural



• Equivalence

FASTER VF
GROMELLE Q-9000

MODEL STRUCTURE

Example;

120.11113JE

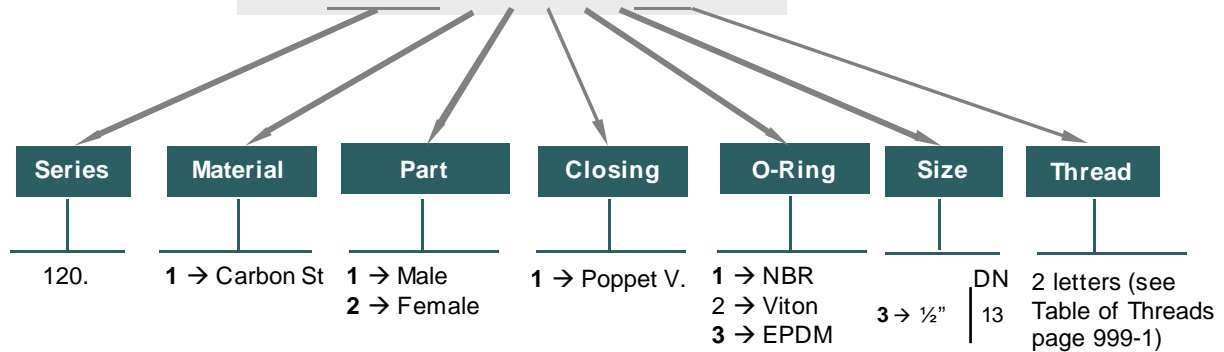



120 SERIES

IFR

DIN 2353 SAE
DIN 3852 / BSP



MALE							
DN	CH1	CH3	C	ØF	E	L	
13	32	$\frac{24}{27}$	51	29	23	*	

• The nut is included in the Bulkhead version

• Manufactured according to ISO 5676 / ISO/TC23 NFU 16006 norms.

★ SPECIAL OPTIONS:

Male with plastic Cap 120.5433AC incorporated, add to base code 010. (Minimum quantity: 250units)

STANDARD MALE MODELS			
DN	ØA	ØT	REF.
13	M18x1,5	12L	120.11113JE
	M20x1,5	Ø13,5	120.11113KFA
	M22x15	15L	120.11113JG
	½" BSP M.	-	120.11113AO
	½" BSP	-	120.11113AD

150Bar

MALE						
DN	CH1	C	ØF	E	L	
13	32	43	29	15	*	

MALE						
DN	CH1	CH2	C	ØF	E	L
13	32	$\frac{24}{27}$	51	29	31	*

FEMALE				
DN	CH2	B	ØD	L
13	27	57	45	*

• Metal parking parts is included in all female parts

STANDARD FEMALE MODELS		
DN	ØA	REF.
13	⅜" BSP	120.12113AC
	½" BSP	120.12113AD
	M18x1.5	120.12113NE
	M20x1.5	120.12113NF

150 Bar





120 SERIES

IFR

DIN 2353
DIN3852 / BSP



• Manufactured according to ISO 5676 / ISO/TC23 NFU 16006 norms.

MALE								
DN	ØA	CH1	C	ØF	E	L	REF.	
13	¾"-16UNF M. (without 37° cone)	32	47,50	29	19,50	*	120.11113HFA	150Bar

MALE								
DN	ØA	CH1	C	ØF	E	L	REF.	
13	¾"-16UNF M. Prolonged	32	90	29	62	*	120.11113GFA	150Bar

MALE											
DN	ØA	ØA1	ØT	CH1	CH2	C	ØF	E	L	REF.	
13	M16x1,5 M20x1,5	M36x2	10L	32	27	54	29	26	*	120.11113JDA	150Bar

• The nut is included in the Bulkhead version

MALE									
DN	ØA	ØT	CH1	C	ØF	E	L	REF.	
13	M22x1,5 Prolonged	15L	32	61,50	29	35	*	120.11113JGA	150Bar

• The nut is included in the Bulkhead version

MALE										
DN	ØA	ØT	CH1	CH2	C	ØF	E	L	REF.	
13	M22x1,5 Bulkhead Prolonged	15L	32	27	77,50	29	49,50	*	120.11113LGA	150Bar

• The nut is included in the Bulkhead version

SPECIAL OPTIONS:
Male with plastic cap
120.5433AC included,
add to base code 010.
(Min. quantity: 250units)



120 SERIES IFR



TECHNICAL DATA

DN	Rated Flow	Min Burst Pressure (bar)			Max. Working Pressure
		Male	Female	Coupled	
13	24 l/m	1360	640	1260	150

* Safety Factor 1:4

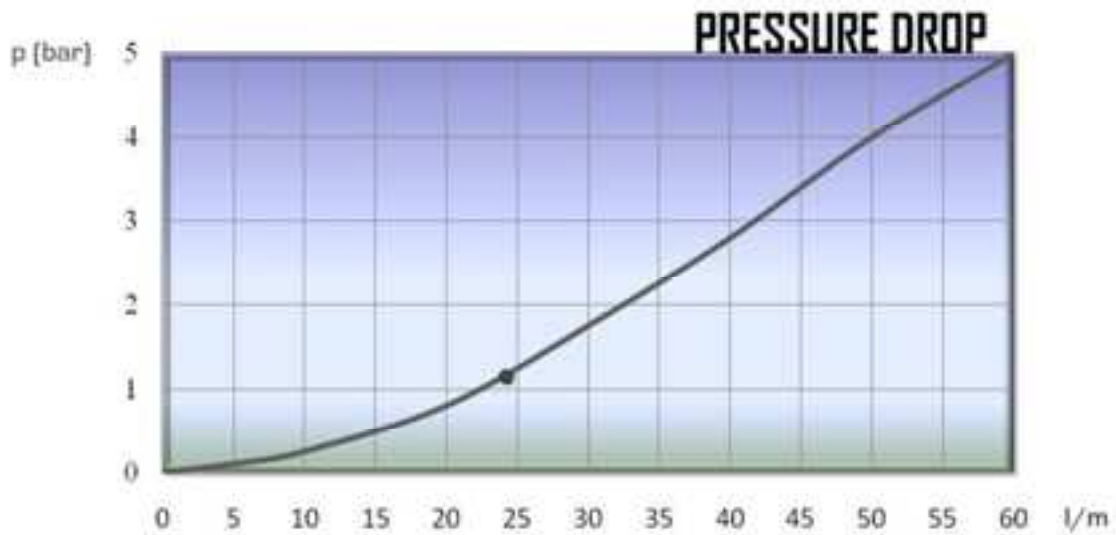



120 SERIES

IFR

CAP &
PARKING

IFR SERIES CAPS have been designed to protect FEMALE parts during disconnection. They have been manufactured according to ISO 5675 / ISO/TC23 / NFU16006 requirements.

MODEL STRUCTURE

For caps and parking parts

Example;

120.5433 AA

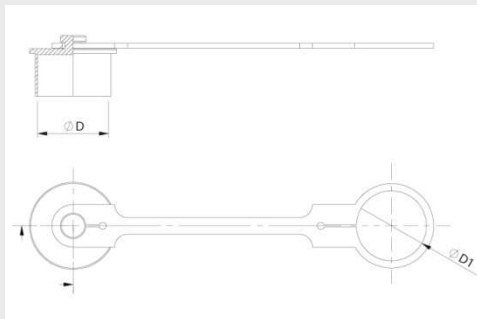
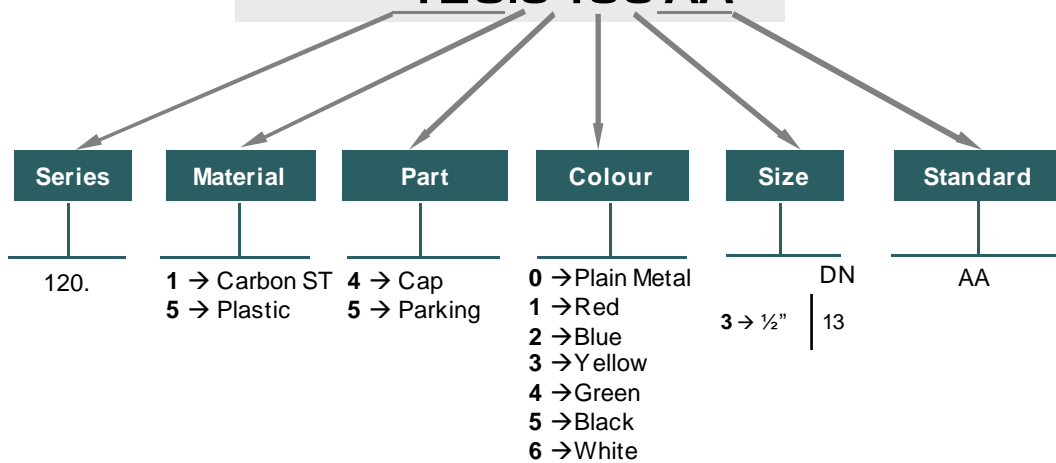

DN	REF.	ØD	ØD1
13	120.5433AA	30	30

Standard in yellow

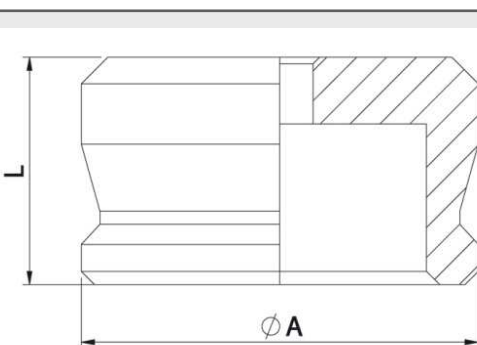

DN	REF.	L	ØA
13	120.1503AA	17	29,80

120-5





122 SERIES

AGR

DIN 2353
DIN3852 / BSP



Designed to connect hydraulic systems of tractor and trailer.
BSP, DIN3852, SAE/ORB thread, other available upon request

• Materials

Carbon Steel EN 10277-3
Seals: NBR, Viton or EPDM
Balls: AISI 316W 14401
Springs: Carbon Steel DIN 17233/84(B)

• Working temperature (Seals)

	NBR	Viton	EPDM
	+100°C	+200°C	+150°C
	-30°C	-10°C	-40°C

• **Applications:** Designed to connect hydraulic systems of a tractor and a trailer. Designed for Oil hydraulic. Applications according to European Directive 97.23.EC

• **Sectors:** Agricultural



• Equivalence

GROMELLE K-8000

MODEL STRUCTURE

Example;

122.11113NE

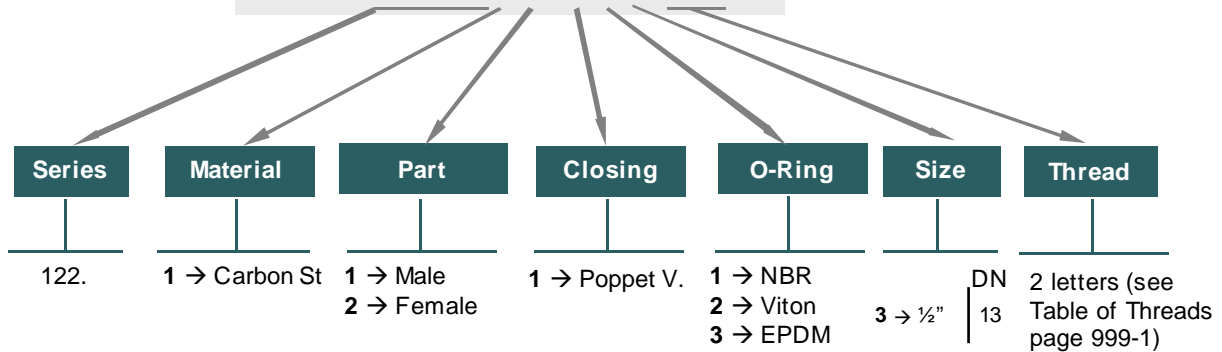



122 SERIES

AGR

DIN 2353
DIN3852 / BSP



• Manufactured according to ISO 5676 / ISO/TC23 NFU 16006 norms.

MALE										
DN	ØA	ØT	CH1	CH2	C	ØA2	E	L	REF.	
13	M18x1,5	12L	36	24	50,50	36	23	*	122.11113JE	250Bar
	M20x1,5	Ø13,5		27					122.11113KFA	
	M22x1,5	15L		122.11113JG						

• The nut is included in the Bulkhead version

MALE								
DN	ØA	CH1	C	ØA2	E	L	REF.	
13	½" BSP M	36	42,50	M36x2	15	*	122.11113AO	250Bar

MALE								
DN	ØA	CH1	CH2	C	ØA2	L	REF.	
13	½" BSP H	36	30	54	M36x2	*	122.11113AD	250Bar

FEMALE							
DN	ØA	CH2	CH4	B	L	REF.	
13	M18x1,5	24	41	58,50	*	122.12113NE	250Bar

• The METAL PARKING is included in all female parts.

FEMALE							
DN	ØA	CH2	CH4	B	L	REF.	
13	½" BSP M Without 60° cone	24	41	42,50	*	122.12113AOA	250Bar

• The METAL PARKING is included in all female parts.

SPECIAL OPTIONS:
Male with plastic cap
120.5433AC included,
add to base code 010.
(Min. quantity: 250units)



122 SERIES

AGR

DIN 2353
SAE/ORB



SPECIAL OPTIONS:
Male with plastic cap
120.5433AC included,
add to base code 010.
(Min. quantity: 250units)

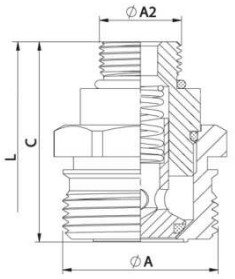

MALE

DN	ØA2	CH1	C	ØA	L	REF.	
13	3/4 "-16UNF M Without 37° cone	36	47	M36x2	*	122.11113HFA	250Bar

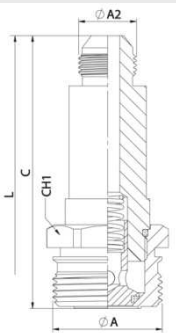

MALE

DN	ØA2	CH1	C	ØA	L	REF.	
13	3/4 "-16UNF M Prolonged	36	89,50	M36x2	*	122.11113GFA	250Bar

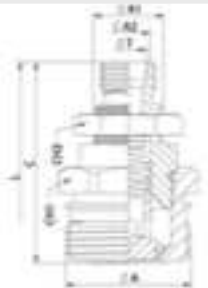

MALE

DN	ØA1	ØA2	ØT	CH1	CH2	C	ØA	L	REF.	
13	M16x1,5	M20x1,5	10L	36	27	53,50	M36x2	*	122.11113JDA	250Bar

• The nut is included in the Bulkhead version

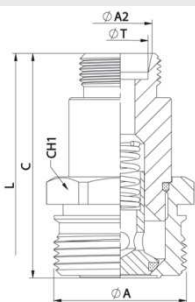

MALE

DN	ØA2	ØT	CH1	C	ØA	L	REF.	
13	M22x1,5 Prolonged	10L	36	61	M36x2	*	122.11113JGA	250Bar

• The nut is included in the Bulkhead version

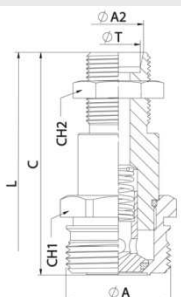

MALE

DN	ØA2	ØT	CH1	CH2	C	ØA	L	REF.	
13	M16x1,5 Prolonged Bulkhead	10L	36	27	77	M36x2	*	122.11113LGA	250Bar

• The nut is included in the Bulkhead version

122-3





122 SERIES AGR CAPS

AGR SERIES CAPS have been designed to protect FEMALE parts during disconnection.

MODEL STRUCTURE For caps and parking parts

Example;

122.5433 AA

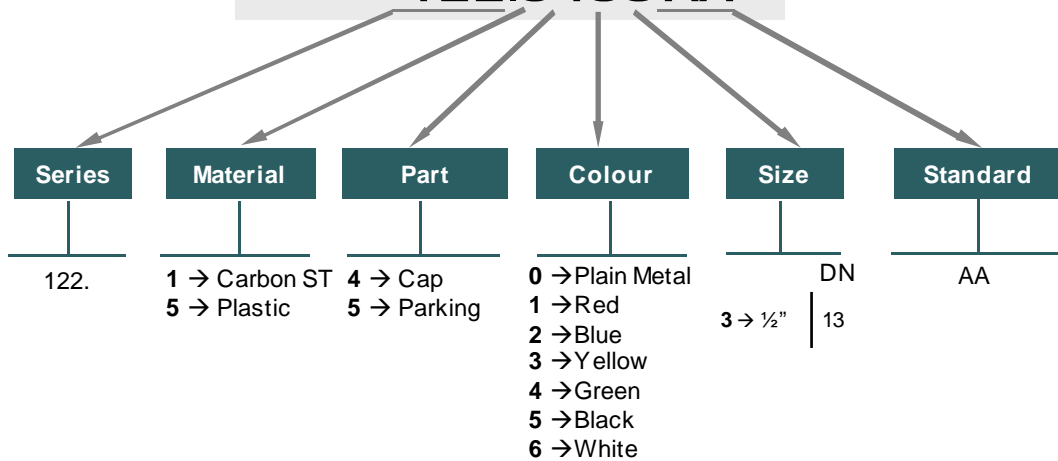

DN	REF.	ØD	ØD1
13	122.5433AA	M36x2	30

Standard in yellow

DN	REF.	L	ØA
13	122.5533AA	17	29,80



123 SERIES AGR+ISO-A



Designed to connect hydraulic systems of tractor and trailer

• Materials

Carbon Steel EN -10277-3
 Seals: NBR, Viton or EPDM
 Balls: AISI 1010/1015
 Springs: Carbon Steel
 DIN 17233/84(B)

• Working temperature (Seals)

	NBR	Viton	EPDM
+	+100°C	+200°C	+150°C
-	-30°C	-10°C	-40°C

• **Applications:** Designed for Oil hydraulic. Applications according to European Directive 97.23EC

• **Sectors:** Agricultural



• Equivalence

GROMELLE K-8000

MODEL STRUCTURE

Example;

123.11113 C

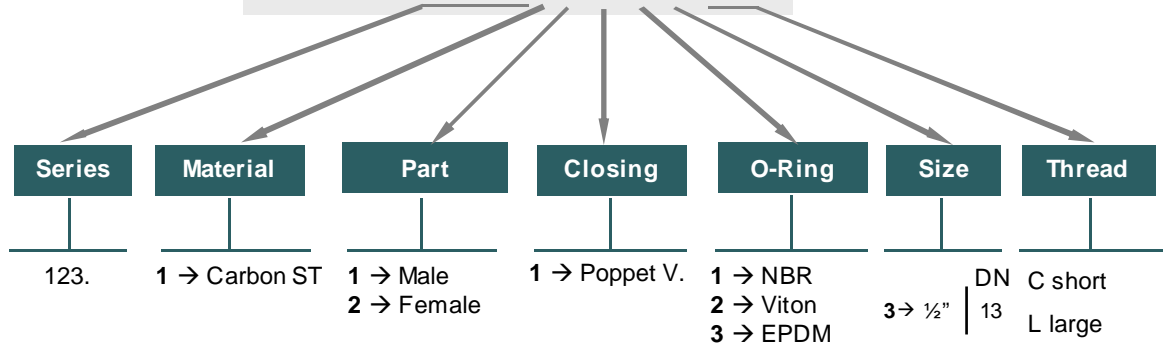





123 SERIES AGR+ISO-A



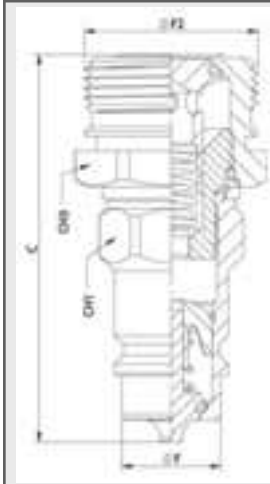

SPECIAL OPTIONS:

Male with plastic cap 122.5433AC included, add 010 at the end of base code. (Min. quantity: 250 units)

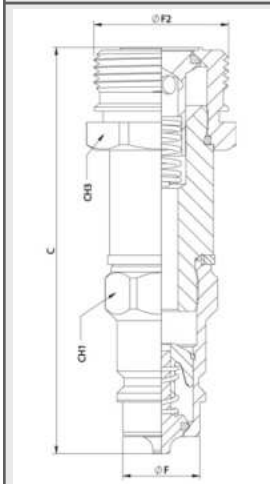

MALE							
DN	CH1	CH3	ØF	ØF2	C	REF.	
13	27	36	20,56	36	76	123.11113C	250Bar



MALE							
DN	CH1	CH3	ØF	ØF2	C	REF.	
13	27	36	20,56	36	104	123.11113L	250Bar

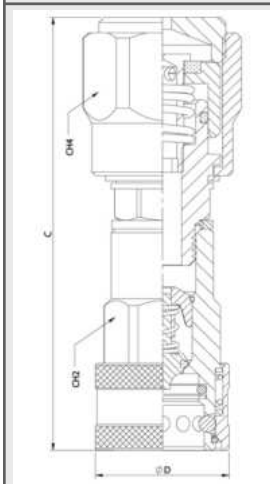

FEMALE						
DN	CH2	CH4	C	ØD	REF.	
13	30	41	124,3	38	123.12113C	250Bar



125 SERIES TFH



Poppet valve or CURP closing system.
BSPT, NPTF, DIN 2353, DIN 3852, SAE/ORB and other threads upon request
AISI 316 available only by minimum quantities

• Materials

Carbon Steel EN -10277-3 / AISI 316L / Brass

Seals: NBR, Viton or EPDM

Back-up-ring: PTFE

Balls: AISI 1010/1015

Springs: Carbon Steel DIN 17233/84(B)

• Working temperature (Seals)

	NBR	Viton	EPDM
+	+100°C	+200°C	+150°C
-	-30°C	-10°C	-40°C

• **Applications:** Designed for Oil hydraulic Applications according to European Directive 97.23.EC

• **Sectors:** Industrial



• Equivalence

RECTUS TEMA T - Series

CEJN Series 525

MODEL STRUCTURE

Example;

125.42315 AF

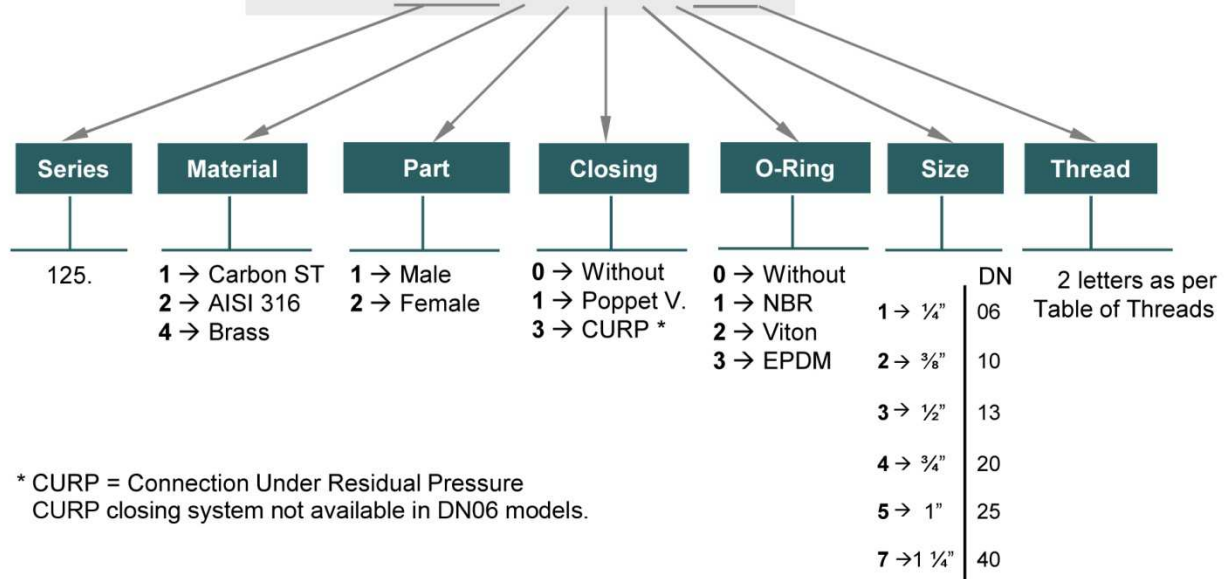

* CURP = Connection Under Residual Pressure
CURP closing system not available in DN06 models.

125-1





125 SERIES

TFH

Carbon Steel



1/4" DN06 (CURP not available)

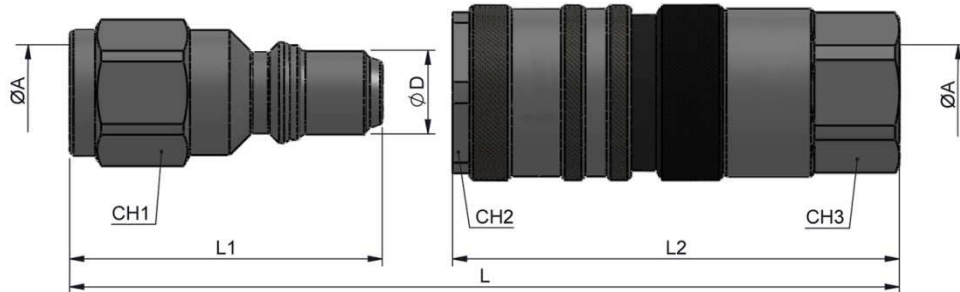

STANDARD MALE MODELS

DN	ØA	REF.		CH1	ØD	L1	L
06	1/4" BSP	125.11111AB	450Bar	19	11,9	45	81

STANDARD FEMALE MODELS

DN	ØA	REF.		CH2	CH3	L2	L
06	1/4" BSP	125.12111AB	450Bar	22	21	64	81

3/8" DN10

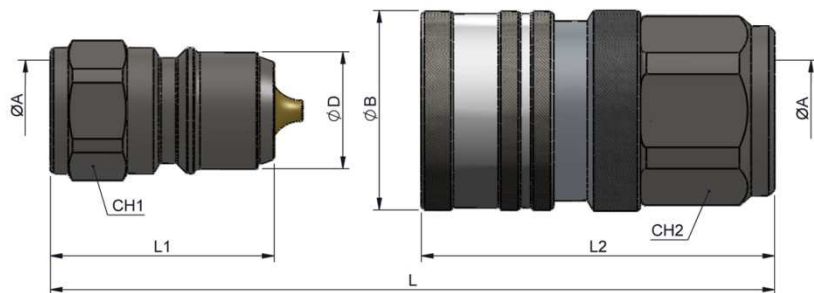

STANDARD MALE MODELS

DN	ØA	REF.		CH1	ØD	L1	L
10	3/8" BSP	125.11112AC	350Bar	22	19,85	38	74

STANDARD FEMALE MODELS

DN	ØA	REF.		CH2	ØB	L2	L
10	3/8" BSP	125.12112AC	350Bar	30	34	60	74

1/2" DN13

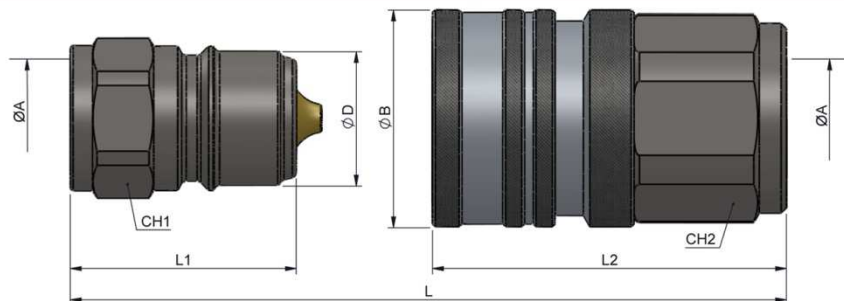

STANDARD MALE MODELS

DN	ØA	REF.		CH1	ØD	L1	L
13	1/2" BSP	125.11113AD	300Bar	27	24,7	41,5	82

STANDARD FEMALE MODELS

DN	ØA	REF.		CH2	ØB	L2	L
13	1/2" BSP	125.12113AD	300Bar	36	40	65	82



125 SERIES

TFH

Carbon Steel



3/4" DN20

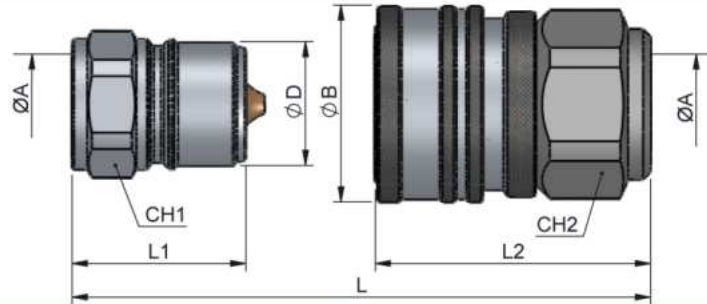

STANDARD MALE MODELS

DN	ØA	REF.	CH1	ØD	L1	L
20	3/4" BSP	125.11114AE 280Bar	36	32,7	46	91

STANDARD FEMALE MODELS

DN	ØA	REF.	CH2	ØB	L2	L
20	3/4" BSP	125.12114AE 280Bar	46	52	72	91

1" DN25

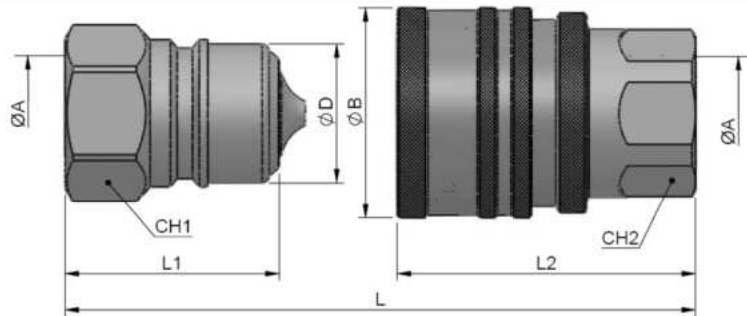

STANDARD MALE MODELS

DN	ØA	REF.	CH1	ØD	L1	L
25	1" BSP	125.11115AF 250Bar	46	40,8	63	115,4

STANDARD FEMALE MODELS

DN	ØA	REF.	CH2	ØB	L2	L
25	1" BSP	125.12115AF 250Bar	46	62	88	115,4

1 1/2" DN40

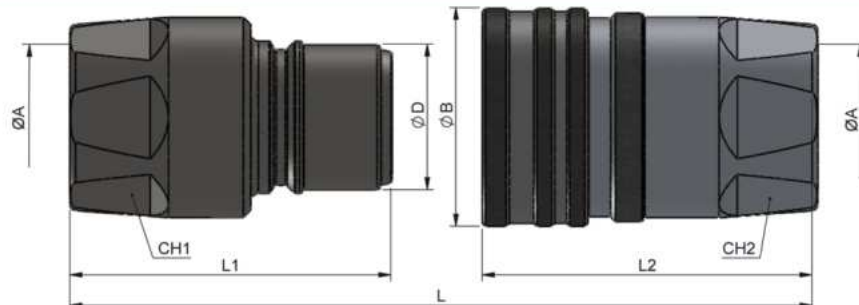

STANDARD MALE MODELS

DN	ØA	REF.	CH1	ØD	L1	L
40	1 1/2" BSP	125.11117AH 200Bar	60	48,5	107	173

STANDARD FEMALE MODELS

DN	ØA	REF.	CH2	ØB	L2	L
40	1 1/2" BSP	125.12117AH 200Bar	60	73	112	173





125 SERIES TFH

PLUGS
& CAPS



TFH SERIES PLUGS/ CAPS have been designed to protect FEMALE (coupler) or MALE (nipple) parts while they are disconnected.
Manufactured according to ISO 7241-A norm, DN13 size meets as well ISO 5675 requirements.

Example;

125.5373 AA

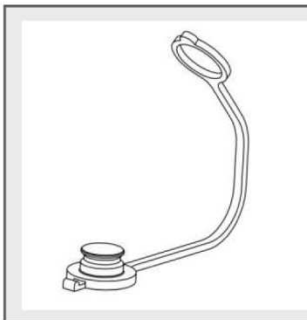
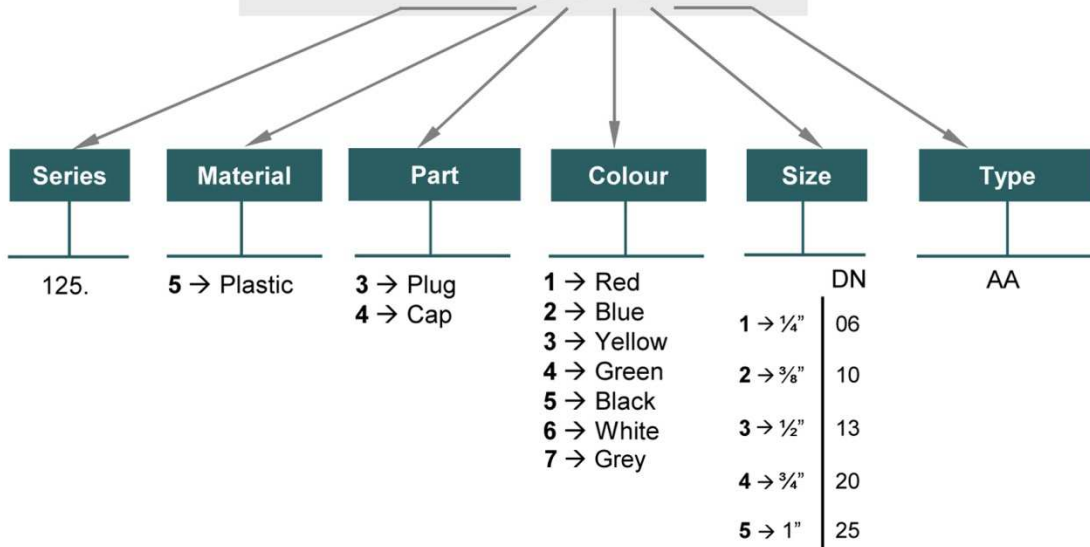

PLUG							
DN	RED	BLUE	YELLOW	GREEN	BLACK	WHITE	GREY
06	*	*	*	*	*	*	125.5371AA
10	*	*	*	*	*	*	125.5372AA
13	*	*	*	*	*	*	125.5373AA
20	*	*	*	*	*	*	125.5374AA
25	*	*	*	*	*	*	125.5375AA

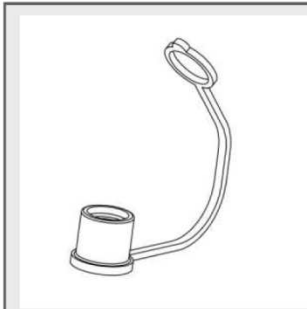

CAP							
DN	RED	BLUE	YELLOW	GREEN	BLACK	WHITE	GREY
06	*	*	*	*	*	*	125.5471AA
10	*	*	*	*	*	*	125.5472AA
13	*	*	*	*	*	*	125.5473AA
20	*	*	*	*	*	*	125.5474AA
25	*	*	*	*	*	*	125.5475AA

* Standard models in color Grey.

Other colors upon request and minimum quantities.

Ask for minimum quantities.





125 SERIES TFH



GRAPHICS

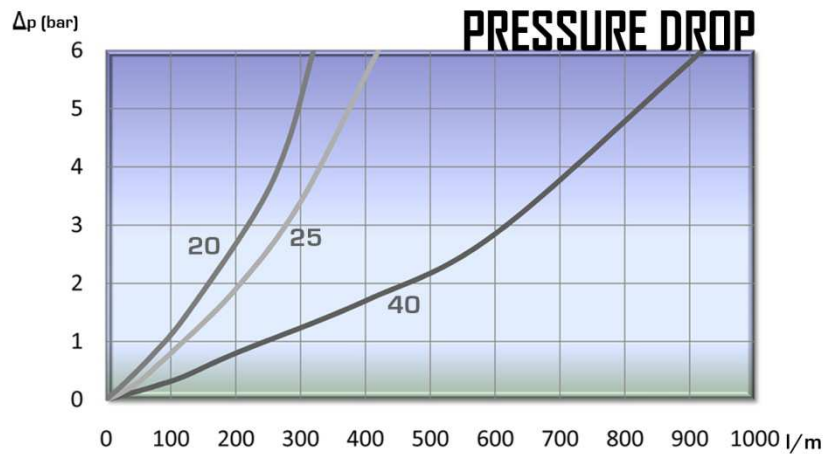
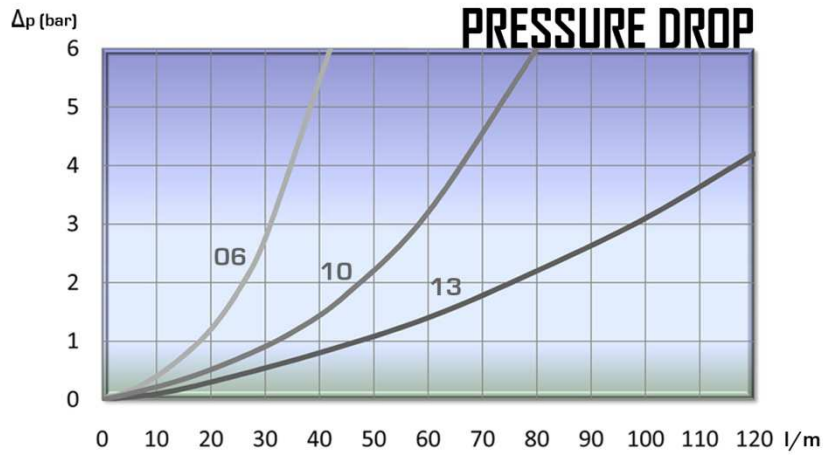

TECHNICAL DATA

DN	Min Burst Pressure (bar)			Max. Working Pressure*
	Male	Female	Coupled	
06	1650	1700	1800	450 bar
10	1320	1400	1400	350 bar
13	1100	1200	1200	300 bar
20	1050	1100	1120	280 bar
25	980	1050	1000	250 bar
40	750	780	800	200 bar

* Safety factor 1:4

125-5





125 SERIES TFH



COSMOS FLOW

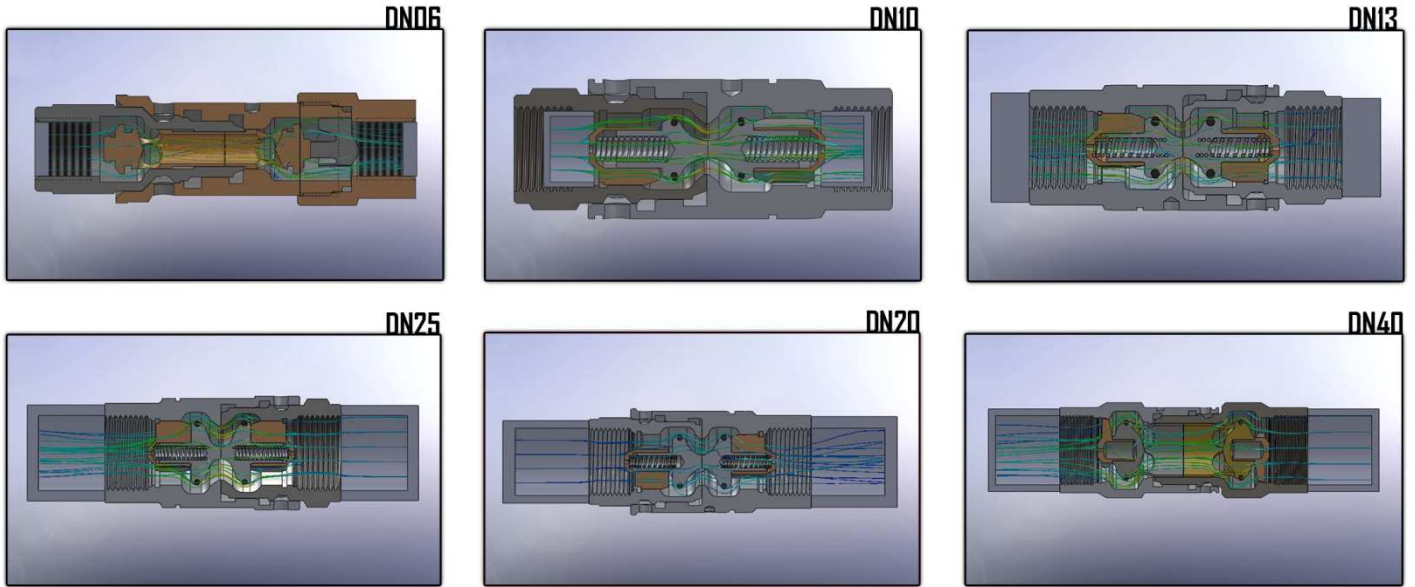

CURP CLOSING SYSTEM

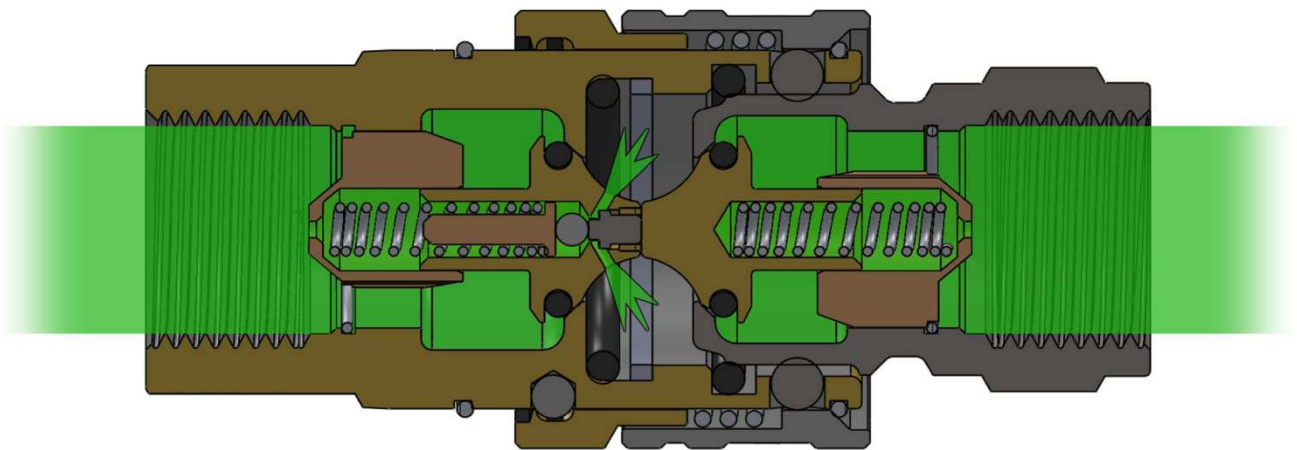

This system allows an easy connection under residual pressure.

125-6



126 SERIES TPL



Big flow and reduced drop pressure.
Available only without valve, free flow

• Materials

Carbon Steel *EN -10277-3, AISI316, Brass DIN-EN 12164*

Seals: *Viton*

Balls: *As version*

Springs: *As version*

• Working temperature (Seals)

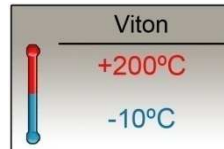

• **Applications:** Designed for Oil and Hot Water. Applications according to European Directive 97.23.EC

• **Sectors:** High pressure cleaning systems

• Equivalence

3/8" TEMA 3800
KEW



MODEL STRUCTURE

Example;

126.12022 AC

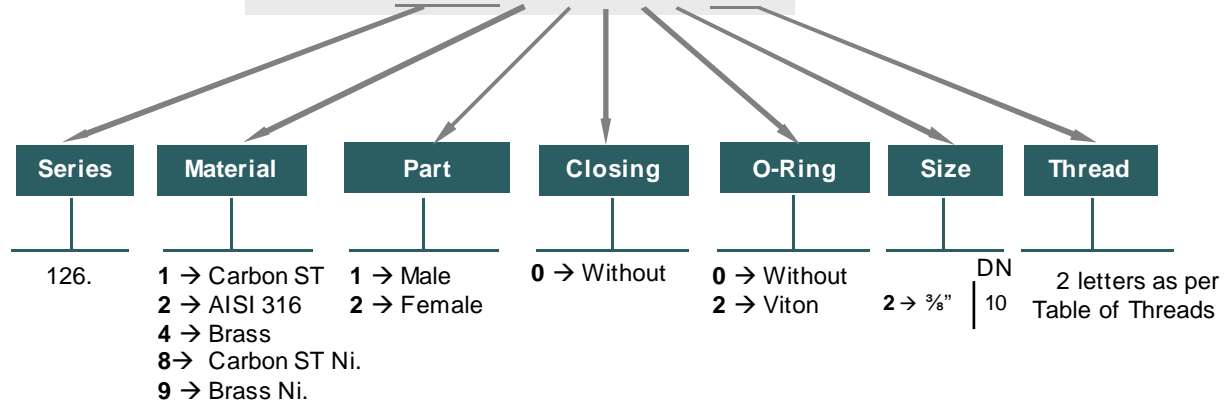



126-1





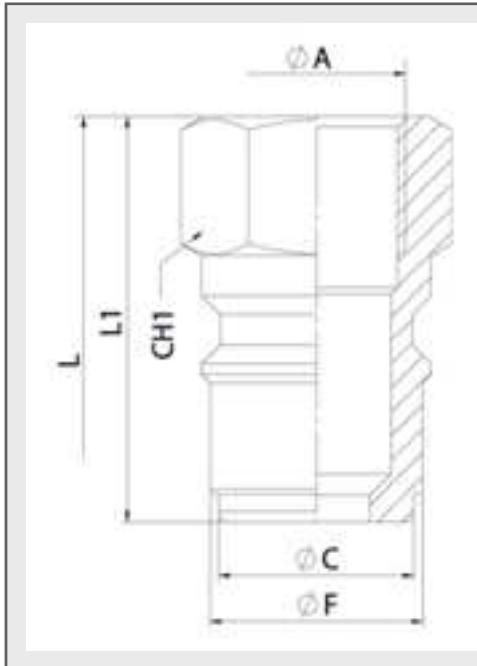

126 SERIES TPL

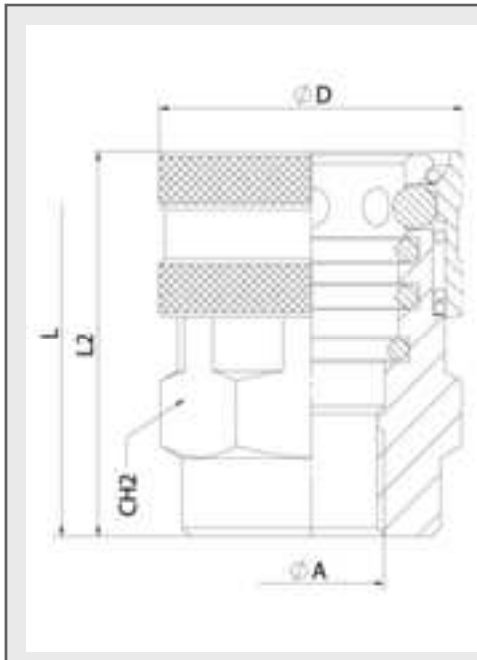

MALE									
DN	ØA	CH1	L1	ØF	ØC	L	MATERIAL	REF.	
10	3/8" BSP	22	38	19,90	18,25	58	White Cr ₃ Passivation (Cr ₆ Free)	126.11002AC	350Bar
							Nickel-plated Carbon Steel	126.81002AC	
							AISI 316	126.21002AC	300 Bar



FEMALE									
DN	ØA	CH2	L2	ØD	L	MATERIAL	REF.		
10	3/8" BSP	30	44	35	58	Nickel-plated Carbon Steel	126.82022AC	350Bar	
						Brass	126.21002AC		90 Bar
						Nickel-plated Brass	126.92022AC		
						AISI316	126.22022AC	300 Bar	



126 SERIES

TPL

PLUGS
& CAPS





TPL SERIES PLUGS/ CAPS have been designed to protect FEMALE (coupler) or MALE (nipple) parts while they are disconnected.

ManUfactured according to ISO 7241-A norm , DN13 size meets as well ISO 5675 requirements.

Example;

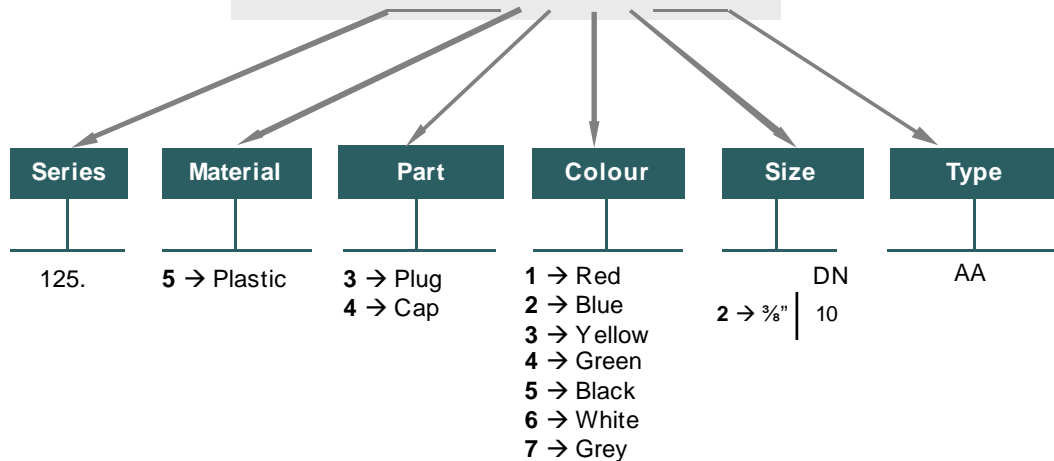
125.5372 AA





PLUG							
DN	RED	BLUE	YELLOW	GREEN	BLACK	WHITE	GREY
10	*	*	*	*	*	*	125.5372AA

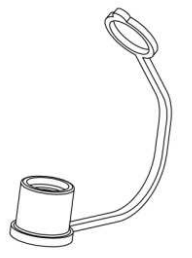

CAP							
DN	RED	BLUE	YELLOW	GREEN	BLACK	WHITE	GREY
10	*	*	*	*	*	*	125.5472AA

- Standard models in color Grey.
- Other colors upon request and minimum quantities.
- Ask for minimum quantities.

126-3





127 SERIES JAP



Specially designed for the Japanese market
Poppet Valve closing system

• Materials

Carbon Steel *EN -10277-3*,

Seals: NBR, Viton or EPDM

Back-up-ring: PTFE

Balls: *AISI 1010/1015*

Springs: *Carbon Steel DIN 17233/84(B)*

• **Applications:** Designed for Oil hydraulic Applications according to European Directive 97.23EC

• Equivalence

FASTER HNVY

• Working temperature (Seals)

	NBR	Viton	EPDM
+	+100°C	+200°C	+150°C
-	-30°C	-10°C	-40°C

• **Sectors:** Agricultural, Industrial



MODEL STRUCTURE

Example;

127.11115AF

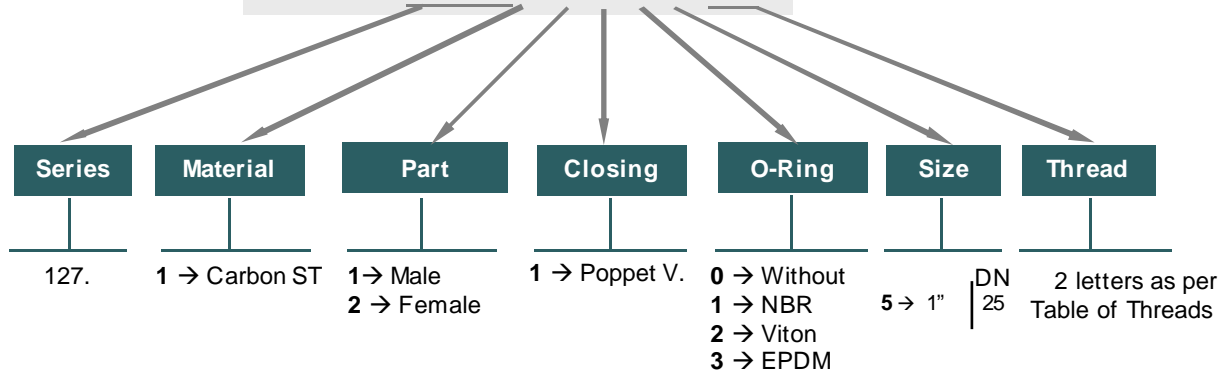



127-1





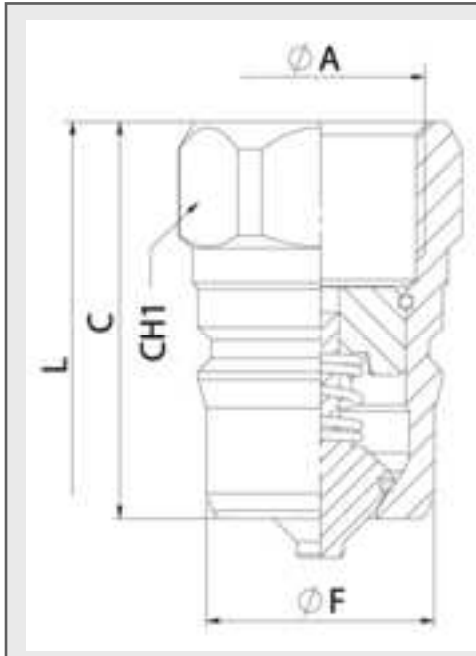

127 SERIES JAP

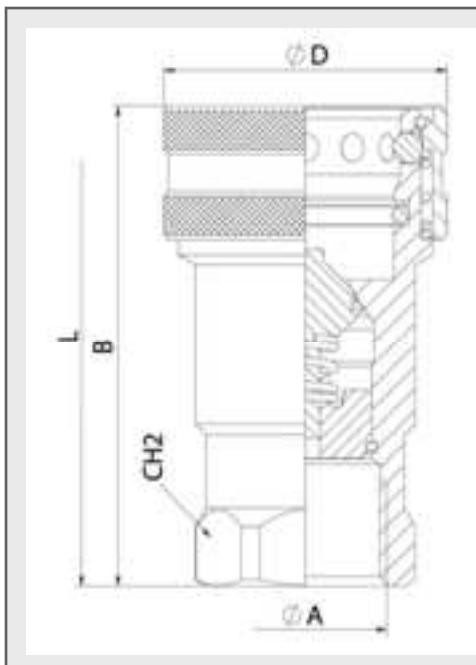

MALE							
DN	ØA	CH1	C	ØF	L	REF.	
25	1" BSP	41	63	36,20	126	127.11115AF	250Bar



FEMALE							
DN	ØA	CH2	B	ØD	L	REF.	
25	1" BSP	41	98	58	126	127.12115AF	250 Bar



128 SERIES TVZ



Manufactured according to the requirements of the most important truck manufacturer.

• Materials

Carbon Steel *EN -10277-3*,

Seals: NBR, Viton or EPDM

Back-up-ring: PTFE

Balls: *AISI 1010/1015*

Springs: *Carbon Steel DIN 17233/84(B)*

• **Applications:** Designed for Oil hydraulic Applications according to European Directive 97.23.EC

• Equivalence

TALLERES ARIZA

• Working temperature (Seals)

	NBR	Viton	EPDM
	+100°C	+200°C	+150°C
	-30°C	-10°C	-40°C

• **Sectors:** Agricultural, Industrial

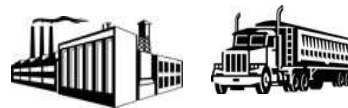

MODEL STRUCTURE

Example;

128.11215AF

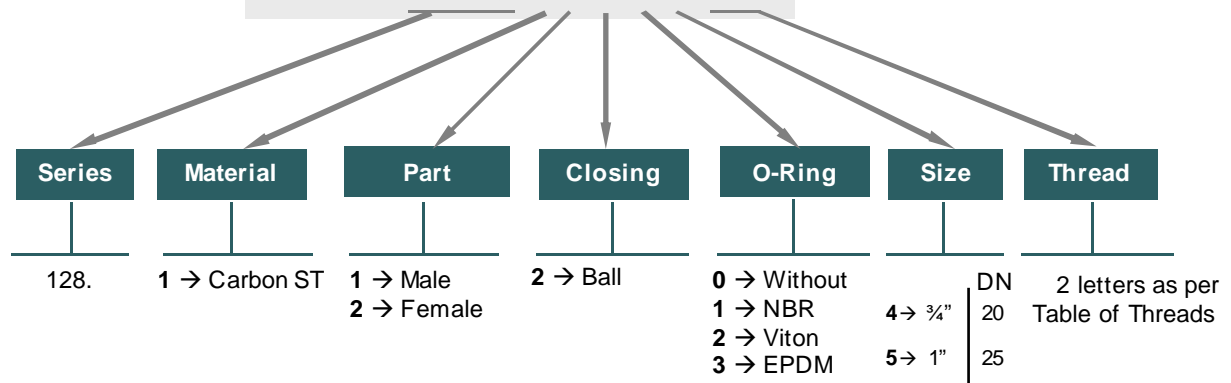



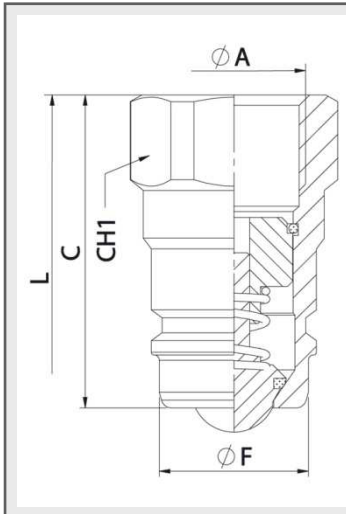

128 SERIES TVZ

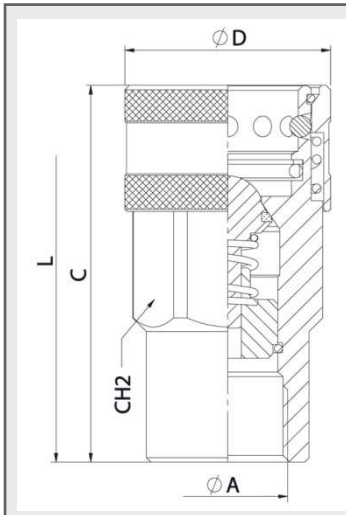

MALE							
DN	$\varnothing A$	CH1	C	$\varnothing F$	L	REF.	
20	3/4" BSP	36	59	28	117,50	128.11214AE	250Bar
25	1" BSP	41	72	36,50	138	128.11215AF	230Bar



FEMALE							
DN	$\varnothing A$	CH2	C	$\varnothing D$	L	REF.	
20	3/4" BSP	38	83,50	45,50	117,50	128.12214AE	250Bar

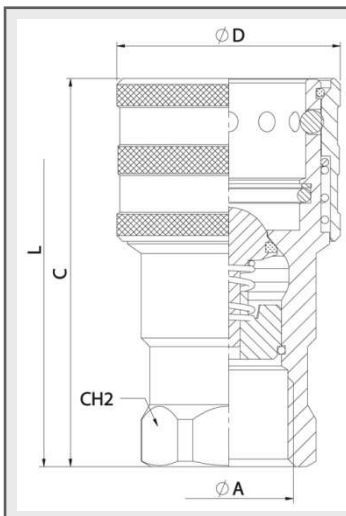

FEMALE							
DN	$\varnothing A$	CH2	C	$\varnothing D$	L	REF.	
25	1" BSP	41	105	57,50	138	128.12215AF	230Bar



129 SERIES

ISO-A SAFETY SLEEVE



Manufactured according to ISO 7241-A norm, DN13 size meets also ISO 5675 requirements. Poppet Valve or Ball closing system.
BSP, NPTF, SAE / ORB threads. Other threads available upon request.

• Materials

Body: *Carbon Steel EN -10277-3, AISI 316, AISI 303, Brass*
 Seals: *NBR, Viton or EPDM*
 Back-Up-Ring: *PTFE*
 Balls: *AISI 1010/1015*
 Springs: *Carbon Steel*
DIN 17233/84(B)

• Working temperature (Seals)

	NBR	Viton	EPDM
+	+100°C	+200°C	+150°C
-	-30°C	-10°C	-40°C

• **Applications:** Designed for Oil hydraulic Applications according to European Directive 97.23.EC

• **Sectors:** Industrial, Agricultural



• Equivalence

FASTER ANV
 AEROQUIP FD56
 PARKER 6600
 SNAP-TITE 61

MODEL STRUCTURE

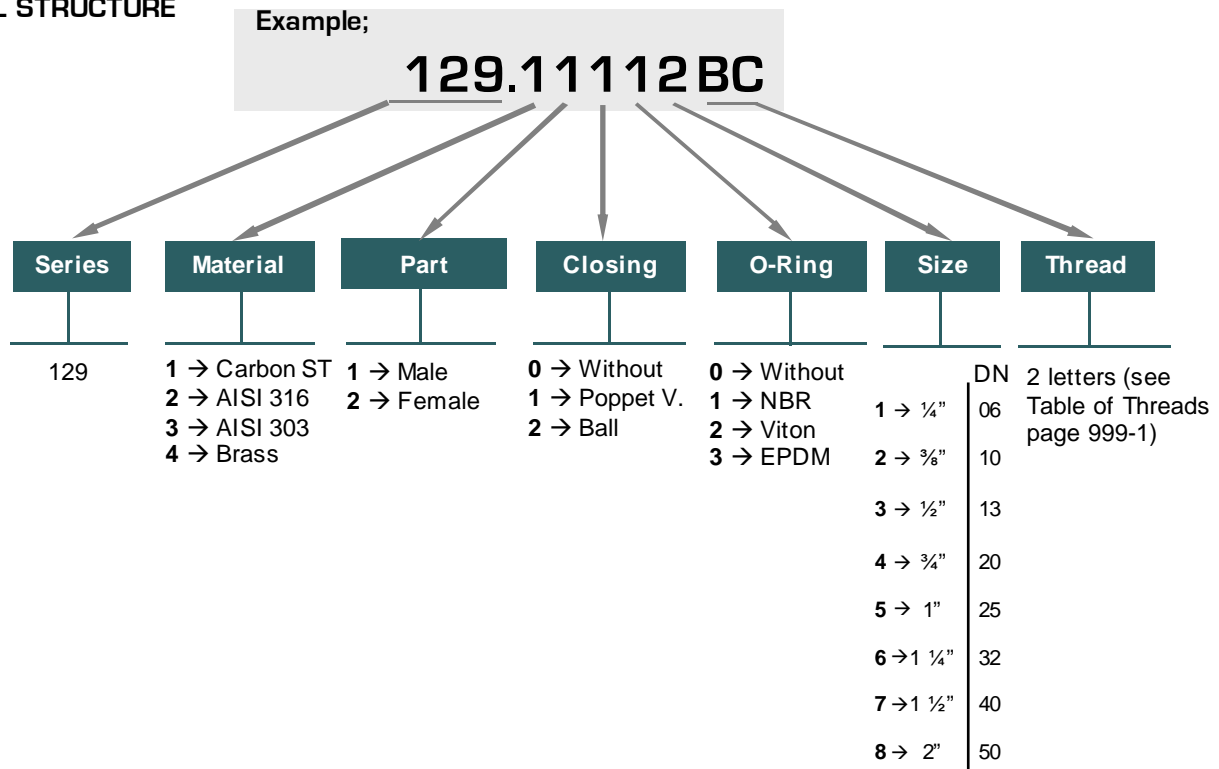

129-1





129 SERIES

ISO-A SAFETY SLEEVE

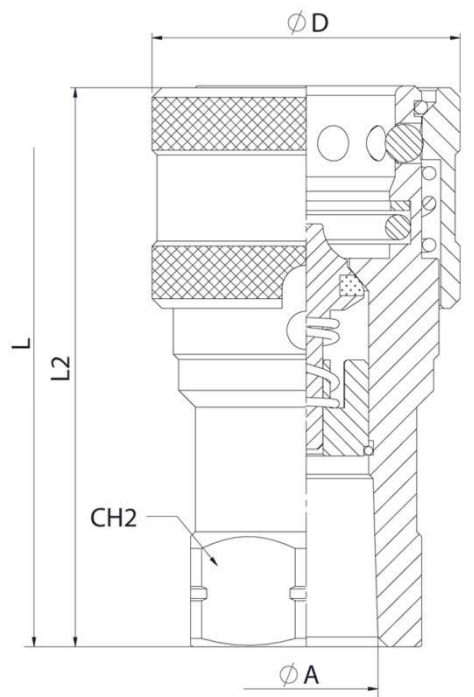

STANDARD MODEL

DN	ϕA	REF.		CH2	L2	ϕD	L
06	1/4" BSP	129.12111AB	350Bar	19	51	26	72
	1/4" NPTF	129.12111BB					
10	3/8" BSP	129.12112AC	300Bar	24	58,50	32	81
	3/8" NPTF	129.12112BC					
	3/8" BSPT	129.12112DC					
13	1/2" BSP	129.12113AD	300Bar	30	63,50	38	87,50
	1/2" NPTF	129.12113BD					
	1/2" BSPT	129.12113DD					
20	3/4" BSP	129.12114AE	250Bar	38	83,50	46	112
	3/4" NPTF	129.12114BE					
25	1" BSP	129.12115AF	230Bar	46	97	55	126
	1" NPTF	129.12115BF					
32	1 1/4" BSP	129.12116AG	230Bar	50	117	70	150
	1 1/4" NPTF	129.12116BG					
40	1 1/2" BSP	129.12117AH	200Bar	60	133	84,50	167
	1 1/2" NPTF	129.12117BH					
50	2" BSP	129.12118AI	130Bar	75	165	100	210
	2" NPTF	129.12118BI					

Manufactured according to ISO 7241-A norm, DN13 size meets as well ISO 5675 requirements



131 SERIES CPR



Manufactured according ISO 16028 norm.
Flat Poppet Valve which avoids fluid leakages during the connection and disconnection.

• Materials

Carbon Steel *EN -10277-3 / AISI 316L*

Seals: NBR. Viton or EPDM

Back-up-ring: PTFE

Balls: *AISI 1010/1015*

Springs: *Carbon Steel DIN 17233/84(B)*

• **Applications:** Designed for Oil hydraulic Applications according to European Directive 97.23.EC

• Equivalence

FASTER 2FFI
PARKER FEM
AEROQUIP FD89
SNAP-TITE 74

• Working temperature (Seals)

	NBR	Viton	EPDM
	+100°C	+200°C	+150°C
	-30°C	-10°C	-40°C

• **Sectors:** Industrial, Building Machinery



MODEL STRUCTURE

Example;

131.11113AD

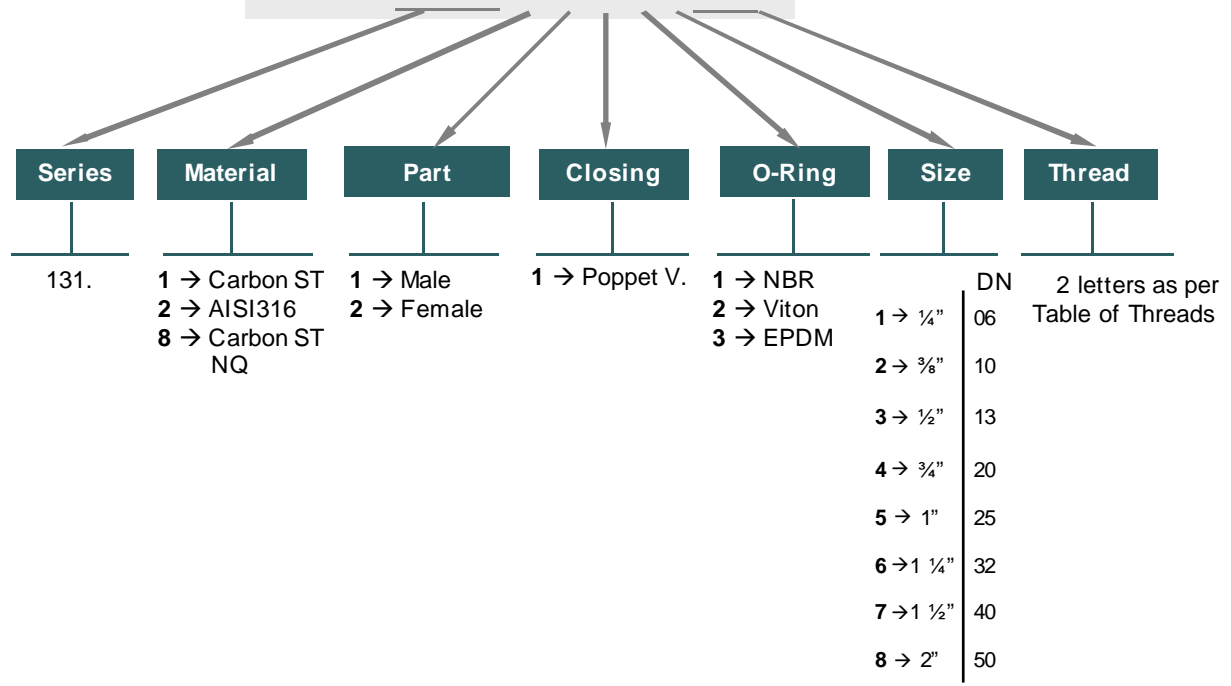

131-1





131 SERIES CPR

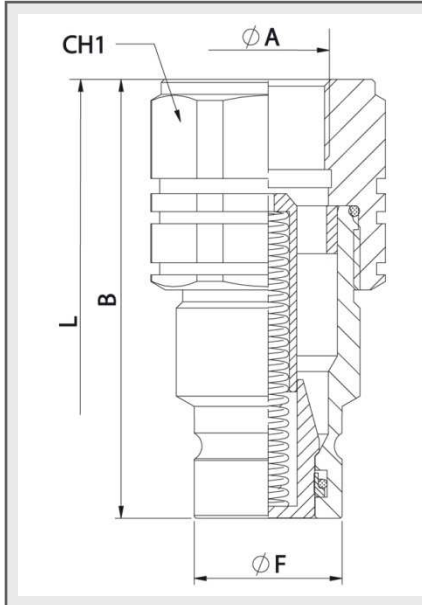

MALE				
DN	CH1	B	ØF	L
07	22	48	16,20	85,50
09	24	62,50	19,80	116,50
13	27	62,50	24,50	134,50
15	36	70,50	27	132
17	45	82,50	30	154
21	55	90	36	173
30	70	111	57	215
45	75	125	73	

STANDARD MODELS

DN	ØA	MALE	FEMALE	
07	1/4" BSP	131.11111AB	131.12111AB	500Bar
		131.11111BB	131.12111BB	
09	3/8" BSP	131.11112AC	131.12112AC	350Bar
		131.11112BC	131.12112BC	
	1/2" BSP	131.11112AD	131.12112DC	
		131.11112BD	131.12112BD	
13	3/4" -16ORB	131.11112GF	131.12112GF	350Bar
		131.11112GH	131.12112GH	
	1/2" BSP	131.11113AD	131.12113AD	
		131.11113BD	131.12113BD	
15	3/4" BSP	131.11113AE	131.12113AE	350Bar
		131.11113BE	131.12113BE	
	3/8" -14ORB	131.11113GH	131.12113GH	
		131.11113GK	131.12113GK	
17	1" BSP	131.11114AE	131.12114AE	350Bar
		131.11114BE	131.12114BE	
	1 1/16"-12ORB	131.11114GK	131.12114GK	
21	1" NPTF	131.11115AF	131.12115AF	350Bar
		131.11115BF	131.12115BF	
	1 5/16"-12ORB	131.11115GO	131.12115GO	
30	1 1/4" BSP	131.11116AG	131.12116AG	350Bar
		131.11116BG	131.12116BG	
45	1 1/2" BSP	131.11117AH	131.12117AH	350Bar
		131.11117BH	131.12117BH	
45	2" BSP	131.11118AI	131.12118AI	250Bar

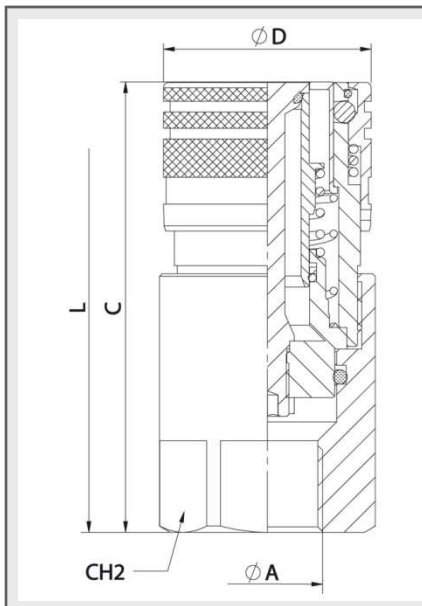

FEMALE				
DN	CH2	C	ØD	L
07	22	48	28	85,50
09	27	64,50	32	116,50
13	32	80,50	38	134,50
15	36	78	42	132
17	45	92,50	48	154
21	55	105	55	173
30	65	132,50	80	215
45	80	165	100	





131 SERIES

CPR

DIN2353

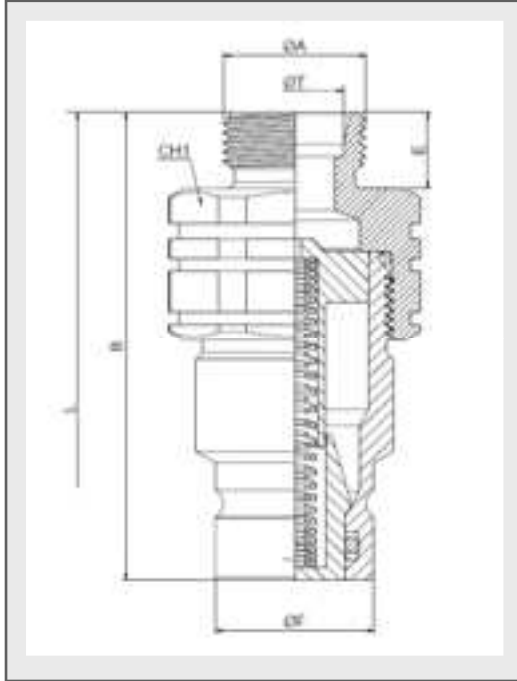

STANDARD MALE MODELS

DN	ØA	ØT	REF.	500 Bar	CH1	B	ØF	E	L				
07	M12x1,5	6L	131.1111JB	500 Bar	22	55	16,2	12	106,2				
	M14x1,5	8L	131.1111JC			54		11	104,2				
	% BSP M.	*	131.1112AN			62,5		12	124,4				
09	M14x1,5	8L	131.1112JC	350 Bar	30	61,5	19,79	11	122,2				
	M16x1,5	10L	131.1112JD			62,5		12	124,4				
	M16x1,5	8S	131.1112KD										
	M18x1,5	10S	131.1112KE										
	M20x1,5	12S	131.1112KF										
	13	M14x1,5	8L			131.1113JC		350 Bar	36	73	24,58	11	134,9
M16x1,5		10L	131.1113JD										
M18x1,5		12L	131.1113JE										
M22x1,5		15L	131.1113JG										
M26x1,5		18L	131.1113JI	74	12	136,9							
M18x1,5		10S	131.1113KE										
M20x1,5		12S	131.1113KF										
M22x1,5		14S	131.1113KG										
M24x1,5		16S	131.1113KH										
15		M18x1,5	12L	131.1114JE	350 Bar	36	74			27,08		12	139,5
	M22x1,5	15L	131.1114JG										
	M26x1,5	18L	131.1114JI										
	M30x2	22L	131.1114JJ	80			18	151,5					
	M22x1,5	14S	131.1114KG										
	M24x1,5	16S	131.1114KH										
	M30x2	20S	131.1114KJ	80			18	151,5					
	M26x1,5	18L	131.1115JI										
	17	M30x2	22L	131.1115JJ			350 Bar	41	88		30	18	164,2
		M36x2	28L	131.1115JK					81			18	157,2
M45x2		35L	131.1115JM										
M30x2		20S	131.1115KJ	46	16	151,2							
M36x2		25S	131.1115KK										
M42x2		30S	131.1115KL	46	18	163,2							
M52x2		38S	131.1115KN										
					55	81			20	153,2			

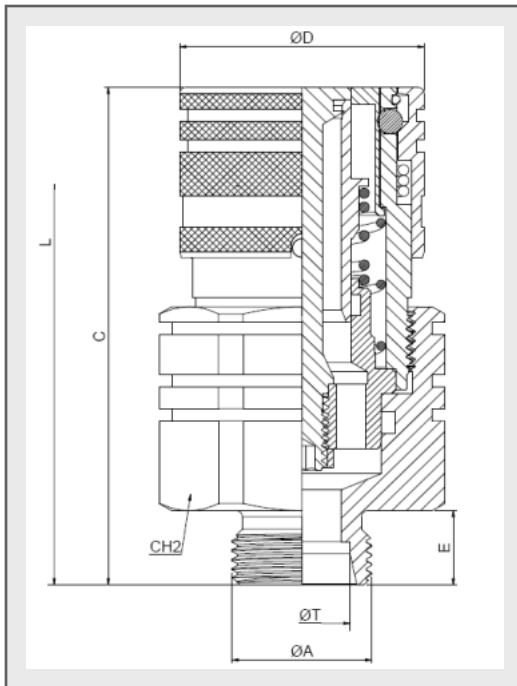

STANDARD FEMALE MODELS

DN	ØA	ØT	REF.	500 Bar	CH2	C	ØD	E	L				
07	M12x1,5	6L	131.1211JB	500 Bar	27	62	27,5	12	106,2				
	M14x1,5	8L	131.1211JC			63		11	104,2				
	% BSP M.	*	131.1212AN			77,5		12	124,4				
09	M14x1,5	8L	131.1212JC	350 Bar	30	76,5	33	11	122,2				
	M16x1,5	10L	131.1212JD			77,5		12	124,4				
	M16x1,5	8S	131.1212KD										
	M18x1,5	10S	131.1212KE										
	M20x1,5	12S	131.1212KF										
	13	M14x1,5	8L			131.1213JC		350 Bar	41	79,5	38,5	11	134,9
M16x1,5		10L	131.1213JD										
M18x1,5		12L	131.1213JE										
M22x1,5		15L	131.1213JG										
M26x1,5		18L	131.1213JI	80,5	12	136,9							
M18x1,5		10S	131.1213KE										
M20x1,5		12S	131.1213KF										
M22x1,5		14S	131.1213KG										
M24x1,5		16S	131.1213KH										
15		M18x1,5	12L	131.1214JE	350 Bar	41	83,1			42		12	139,5
	M22x1,5	15L	131.1214JG										
	M26x1,5	18L	131.1214JI										
	M30x2	22L	131.1214JJ	89,1			18	151,5					
	M22x1,5	14S	131.1214KG										
	M24x1,5	16S	131.1214KH										
	M30x2	20S	131.1214KJ	89,1			18	151,5					
	M26x1,5	18L	131.1215JI										
	17	M30x2	22L	131.1215JJ			350 Bar	46	92		30	12	152,2
		M36x2	28L	131.1215JK					98			18	164,2
M45x2		35L	131.1215JM										
M30x2		20S	131.1215KJ	99	16	151,2							
M36x2		25S	131.1215KK										
M42x2		30S	131.1215KL	96	18	163,2							
M52x2		38S	131.1215KN										
					55	94			20	153,2			



131 SERIES CPR

DIN2353

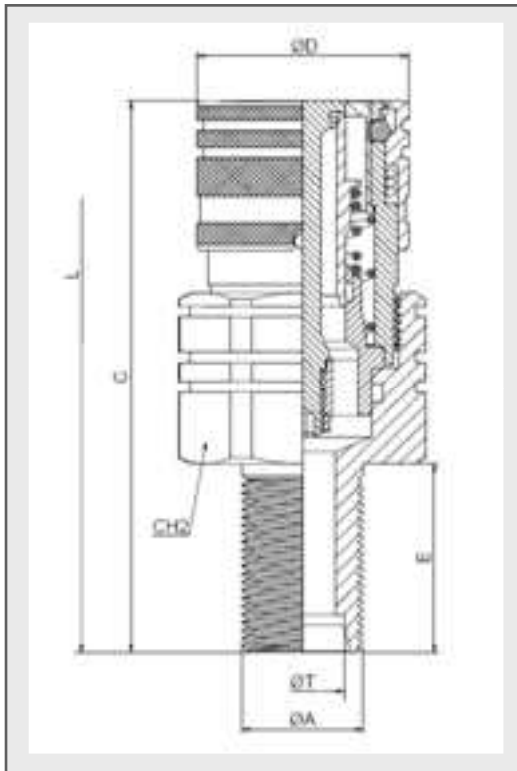
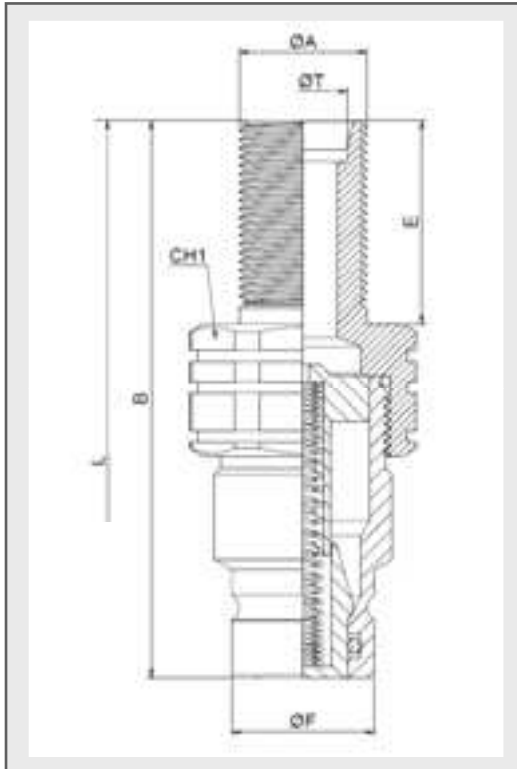

STANDARD MALE MODELS

DN	ØA	ØT	REF.		CH1	B	ØF	E	L									
07	M12x1,5	6L	131.1111LB	500Bar	22	68	16,2	25	132,2									
	M14x1,5	8L	131.1111LC			77				34	150,2							
	M14x1,5	8L	131.11112LC			84,5				34	168,2							
09	M16x1,5	10L	131.11112LD	350Bar	30	85,5	19,79	35	170,2									
	M16x1,5	8S	131.11112MD			76,5				26	152,2							
	M18x1,5	10S	131.11112ME			77,5				27	154,2							
13	M20x1,5	12S	131.11112MF	350Bar	36	85,5	24,58	35	170,2									
	M14x1,5	8L	131.11113LC			97				183								
	M16x1,5	10L	131.11113LD															
	M18x1,5	12L	131.11113LE															
	M22x1,5	15L	131.11113LG			97				182								
	M26x1,5	18L	131.11113LI								350Bar	36	96	24,58	35	181		
	M18x1,5	10S	131.11113ME															
	M20x1,5	12S	131.11113MF															
	M22x1,5	14S	131.11113MG			97				182								
	M24x1,5	16S	131.11113MH															
M18x1,5	12I	131.11114LE	350Bar	36	96		27,08	35	183,5									
M22x1,5	15L	131.11114LG																
M26x1,5	18L	131.11114LI																
15	M30x2	22L	131.11114LJ	350Bar	41	106	27,08	35	183,5									
	M24x1,5	16S	131.11114MH							97	184,5							
	M30x2	20S	131.11114MJ															
	M26x1,5	18L	131.11115LI															
	M30x2	22L	131.11115LJ							41	199,2							
	M36x2	28L	131.11115LK															
	M45x2	35L	131.11115LM															
	17	M30x2	20S							131.11115MJ	350Bar	46	106	30	34	190,2		
		M36x2	25S							131.11115MK							41	205,2
		M42x2	30S							131.11115ML								
M52x2		38S	131.11115MN															

STANDARD FEMALE MODELS

DN	ØA	ØT	REF.		CH2	C	ØD	E	L									
07	M12x1,5	6L	131.12111LB	500Bar	27	75	27,5	25	132,2									
	M14x1,5	8L	131.12111LC			84				34	150,2							
	M14x1,5	8L	131.12112LC			99,5				34	168,2							
09	M16x1,5	10L	131.12112LD	350Bar	30	100,5	33	35	170,2									
	M16x1,5	8S	131.12112MD			91,5				26	152,2							
	M18x1,5	10S	131.12112ME			92,5				27	154,2							
13	M20x1,5	12S	131.12112MF	350Bar	41	100,5	38,5	35	170,2									
	M14x1,5	8L	131.12113LC			102,5				182								
	M16x1,5	10L	131.12113LD															
	M18x1,5	12L	131.12113LE															
	M22x1,5	15L	131.12113LG			103,5				183								
	M26x1,5	18L	131.12113LI								350Bar	41	102,5	38,5	35	181		
	M18x1,5	10S	131.12113ME															
	M20x1,5	12S	131.12113MF															
	M22x1,5	14S	131.12113MG			103,5				182								
	M24x1,5	16S	131.12113MH															
M18x1,5	12I	131.12114LE	350Bar	41	105,1		42	35	183,5									
M22x1,5	15L	131.12114LG																
M26x1,5	18L	131.12114LI																
15	M30x2	22L	131.12114LJ	350Bar	46	115	48,5	35	184,5									
	M24x1,5	16S	131.12114MH							106,1	185,5							
	M30x2	20S	131.12114MJ															
	M26x1,5	18L	131.12115LI															
	M30x2	22L	131.12115LJ							114	199,2							
	M36x2	28L	131.12115LK															
	M45x2	35L	131.12115LM															
	17	M30x2	20S							131.12115MJ	350Bar	46	114	48,5	34	190,2		
		M36x2	25S							131.12115MK							108	186,2
		M42x2	30S							131.12115ML								
M52x2		38S	131.12115MN															





131 SERIES

CPR

STAINLESS STEEL
AISI 316



Manufactured according ISO 16028 norm.
Flat Poppet Valve which avoids fluid leakages during the connection and disconnection.

• Materials

Stainless steel AISI 316
Seals: NBR, Viton or EPDM
Back-up-ring: PTFE
Balls: AISI 1010/1015
Springs: AISI302 DIN17224

• Working temperature (Seals)

	NBR	Viton	EPDM
	+100°C	+200°C	+150°C
	-30°C	-10°C	-40°C

• **Applications:** Designed for Oil hydraulic Applications according to European Directive 97.23.EC Special for American market

• **Sectors:** Industrial, Chemical



MODEL STRUCTURE

Example;

131.21123AD

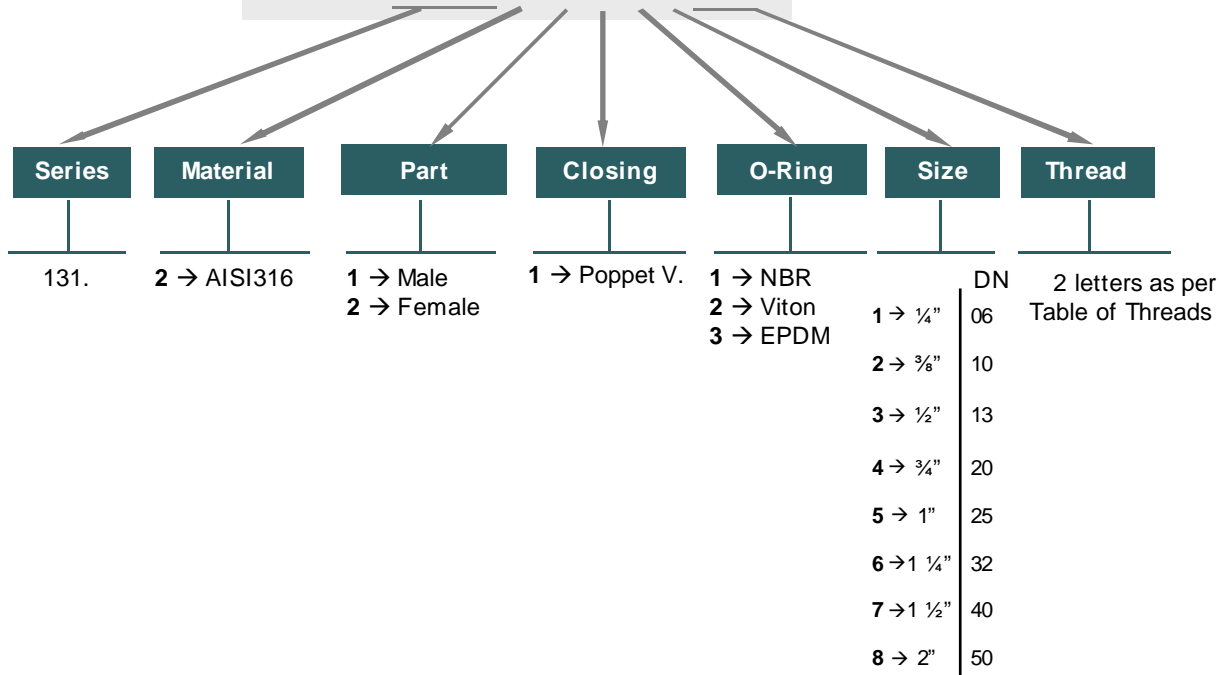

131-5





131 SERIES

CPR

STAINLESS STEEL
AISI 316

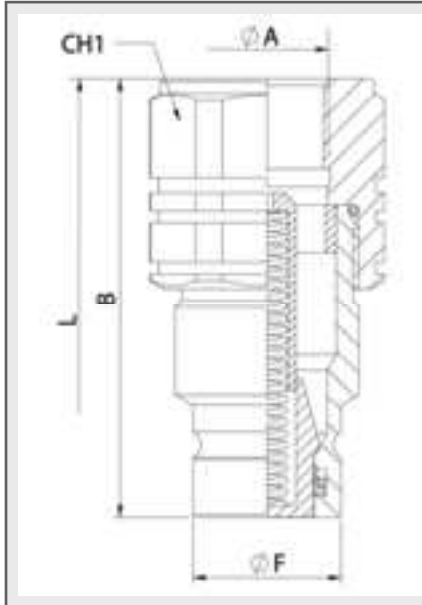

MALE				
DN	CH1	B	ØF	L
07	22	48	16,20	85,50
09	24	62,50	19,80	116,50
13	27	62,50	24,50	134,50
15	36	70,50	27	132
17	45	82,50	30	154
21	55	90	36	173
30	70	111	57	215
45	75	125	73	

STANDARD MODELS

DN	ØA	MALE	FEMALE	
07	1/4" BSP	131.21121AB	131.22121AB	350Bar
	1/4" NPTF	131.21121BB	131.22121BB	
	3/8" BSP	131.21122AC	131.22122AC	
09	3/8" NPTF	131.21122BC	131.22122BC	250Bar
	1/2" BSP	131.21122AD	131.22122DC	
	1/2" NPTF	131.21122BD	131.22122BD	
	3/4" -16ORB	131.21122GF	131.22122GF	
13	7/8" -14ORB	131.21122GH	131.22122GH	250Bar
	1/2" BSP	131.21123AD	131.22123AD	
	1/2" NPTF	131.21123BD	131.22123BD	
	3/4" BSP	131.21123AE	131.22123AE	
	3/4" NPTF	131.21123BE	131.22123BE	
15	7/8" -14ORB	131.21123GH	131.22123GH	250Bar
	1 1/16" 12ORB	131.21123GK	131.22123GK	
	3/4" BSP	131.21124AE	131.22124AE	
17	3/4" NPTF	131.21124BE	131.22124BE	250Bar
	1 1/16" -12ORB	131.21124GK	131.22124GK	
21	1" BSP	131.21125AF	131.22125AF	250Bar
	1" NPTF	131.21125BF	131.22125BF	
	1 5/16" -12ORB	131.21125GO	131.22125GO	
30	1 1/4" BSP	131.21126AG	131.22126AG	250Bar
	1 1/4" NPTF	131.21126BG	131.22126BG	
45	1 1/2" BSP	131.21127AH	131.22127AH	250Bar
	1 1/2" NPTF	131.21127BH	131.22127BH	
45	2" BSP	131.21128AI	131.22128AI	100Bar

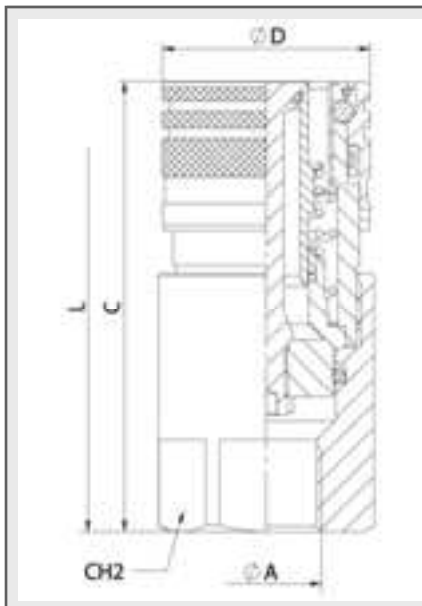

FEMALE				
DN	CH2	C	ØD	L
07	22	48	28	85,50
09	27	64,50	32	116,50
13	32	80,50	38	134,50
15	36	78	42	132
17	45	92,50	48	154
21	55	105	55	173
30	65	132,50	80	215
45	80	165	100	





131 SERIES CPR



TECHNICAL DATA

DN	Rated Flow	Min Burst Pressure (bar)			Max. Working Pressure *
		Male	Female	Coupled	
07	18 l/m	1950	1890	2000	500 bar
09	45 l/m	1300	1200	1400	350 bar
13	75 l/m	1300	1200	1400	350 bar
15	150 l/m	1250	1180	1400	350 bar
17	200 l/m	1200	1150	1400	350 bar
21	220 l/m	1150	1150	1400	350 bar
30	240 l/m	1080	1100	1400	350 bar

* Safety factor 1:4
Carbon Steel Models

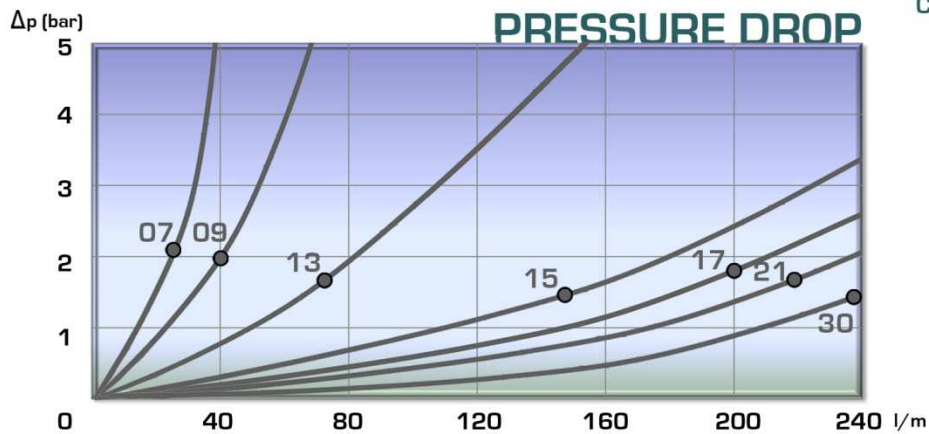

TECHNICAL DATA

DN	Rated Flow	Min Burst Pressure (bar)			Max. Working Pressure
		Male	Female	Coupled	
07	18 l/m	1450	1400	1400	350 bar
09	45 l/m	1020	1100	1000	250 bar
13	75 l/m	1000	980	1000	250 bar
15	150 l/m	950	970	1000	250 bar
17	200 l/m	950	940	1000	250 bar
21	220 l/m	930	900	1000	250 bar
30	240 l/m	930	890	1000	250 bar

* Safety factor 1:4
Stainless Steel Models

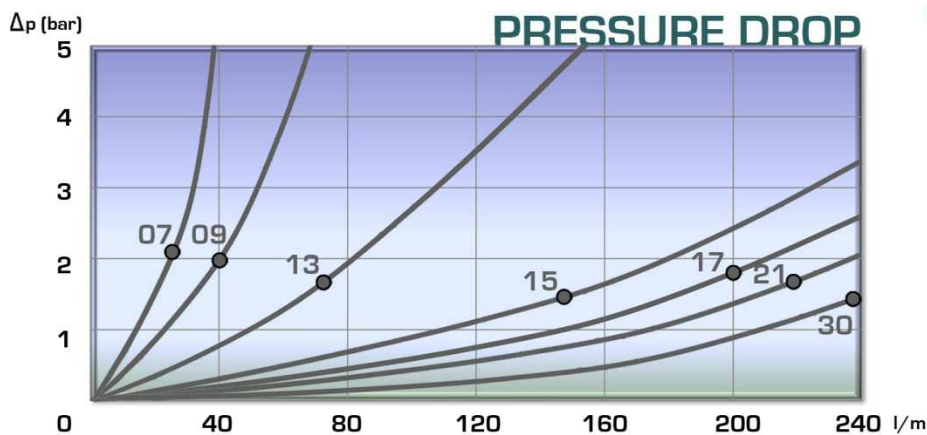



131-7



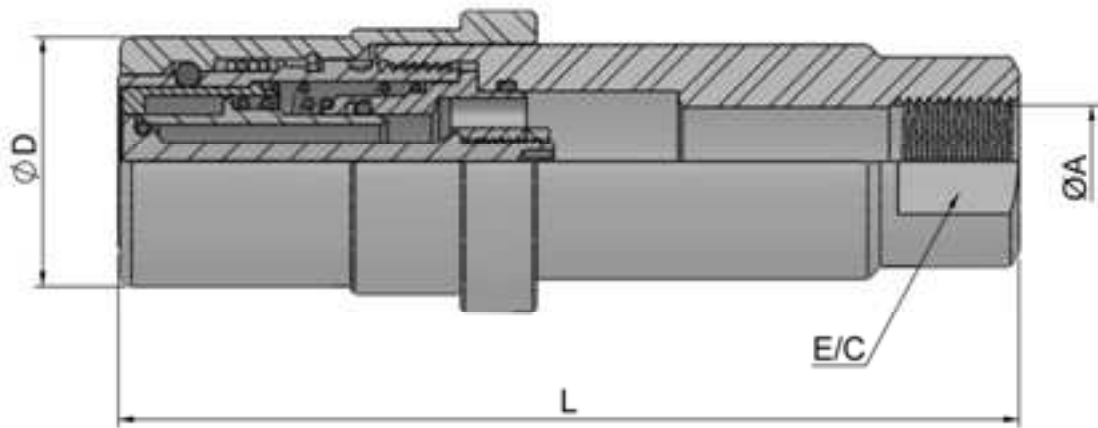
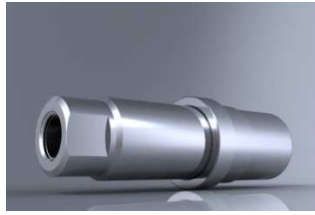

131 SERIES CPR



STANDARD MODEL CARBON STEEL						
DN	ØA	REF.		E/C	ØD	L
09	3/8" BSP	131B.12112AC	350	24	33	119

TECHNICAL DATA					
DN	Nominal Flow	Min. Burst Pressure			Max. Working Pressure
		Male	Female	Coupled	
09	45 l/m	1300	1200	1400	350 bar

Designation

DN-09 FLAT FACE FEMALE 3/8" high pressure to lift trash containers

Features:

- ✓ Developed for use in working with high frequency pulsating pressure and water hammer.
- ✓ Pressure: 350 bar.
- ✓ Connectable with a residual mean pressure.
- ✓ Nickel plated outer body chemical, very corrosion resistant to ensure durability under the most extreme
- ✓ Ergonomically shaped for easy connection and disconnection.
- ✓ Compact flat face that eliminates leaks and contamination of the circuit.
- ✓ Manufactured under ISO 16028.

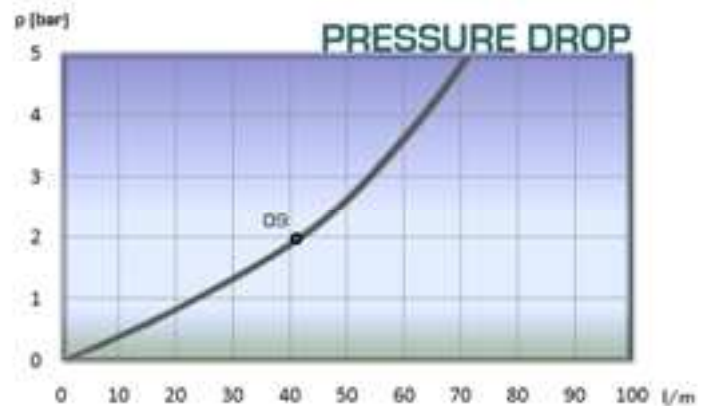



131 SERIES

CPR CAPS



CPR SERIES CAPS have been designed to protect FEMALE (coupler) or MALE (nipple) parts while they are disconnected.
Manufactured according to ISO 16028 norm.

MODEL STRUCTURE

For caps

Example;

131.5313 AA

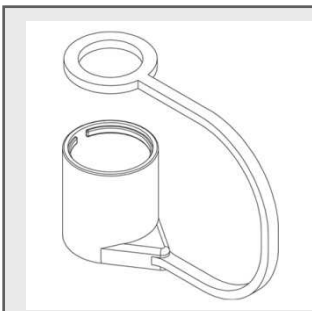
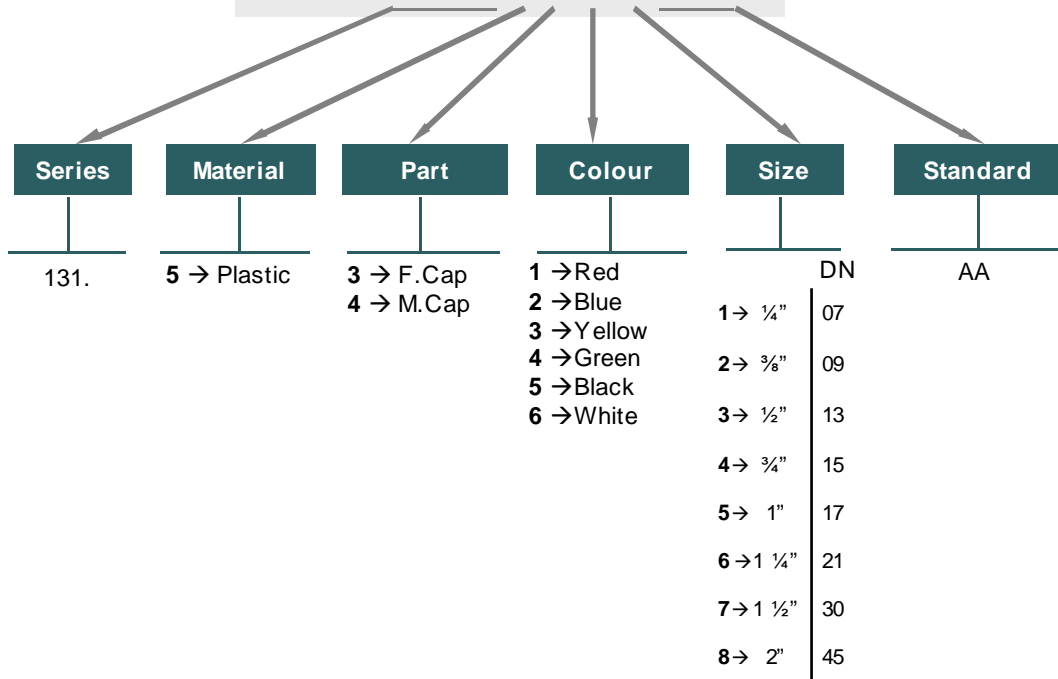

FEMALE CAP						
DN	RED	BLUE	YELLOW	GREEN	BLACK	WHITE
07	131.5311AA	*	*	*	*	*
09	131.5312AA	*	*	*	*	*
13	131.5313AA	*	*	*	*	*
15	131.5314AA	*	*	*	*	*
17	131.5315AA	*	*	*	*	*

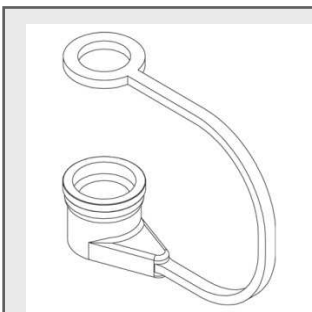

MALE CAP						
DN	RED	BLUE	YELLOW	GREEN	BLACK	WHITE
07	131.5411AA	*	*	*	*	*
09	131.5412AA	*	*	*	*	*
13	131.5413AA	*	*	*	*	*
15	131.5414AA	*	*	*	*	*
17	131.5415AA	*	*	*	*	*

* Available upon request

* Use 131 instead of 130 in reference to ask for CPR Caps

131-9





140 SERIES CVF



Free flow (without valve)
BSP Threads, other threads available upon request.

• Materials

Carbon Steel *EN -10277-3 / AISI 316L / Brass*

Seals: NBR, Viton or EPDM

Back-up-ring: PTFE

Balls: *AISI 1010 / 1015*

Springs: *Carbon Steel DIN 17233 / 84(B)*

• **Applications:** Designed for Oil hydraulic Applications according to European Directive 97.23EC

• Equivalence

GROMELLE 7000

• Working temperature (Seals)

	NBR	Viton	EPDM
	+100°C	+200°C	+150°C
	-30°C	-10°C	-40°C

• **Sectors:** Industrial, High pressure cleaning systems

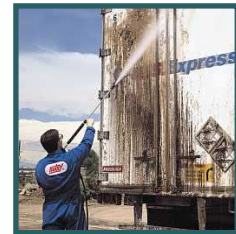

MODEL STRUCTURE

Example;

140.11001 AB

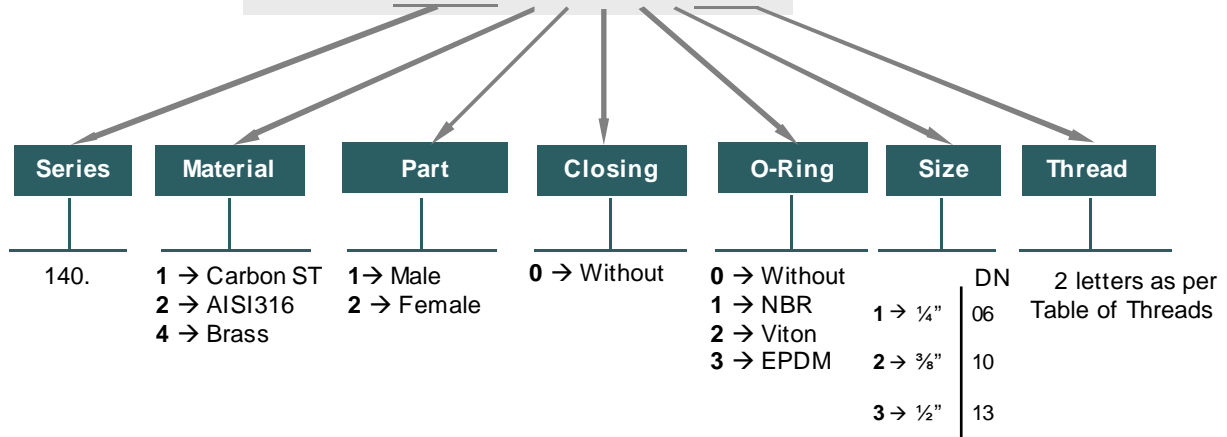

140-1





140 SERIES CVF



Quick couplings upon request and subjected to minimum quantities.
Nickel-palated product → add 011 at the end of the reference.

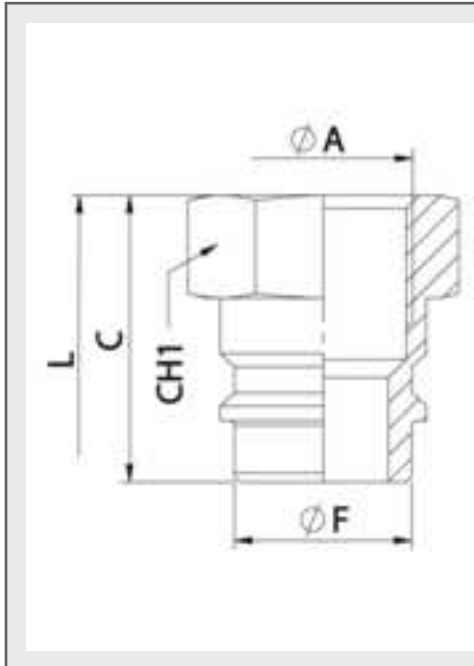

MALE (<i>CARBON ST.</i>)							
DN	ØA	CH1	C	ØF	L	REF.	
06	¼" BSP	19	25	14,10	45,10	140.11001AB	700 Bar
10	⅜" BSP	22	28	18,90	48,50	140.11002AC	600 Bar
13	½" BSP	27	33	20,40	55,50	140.11003AD	500 Bar

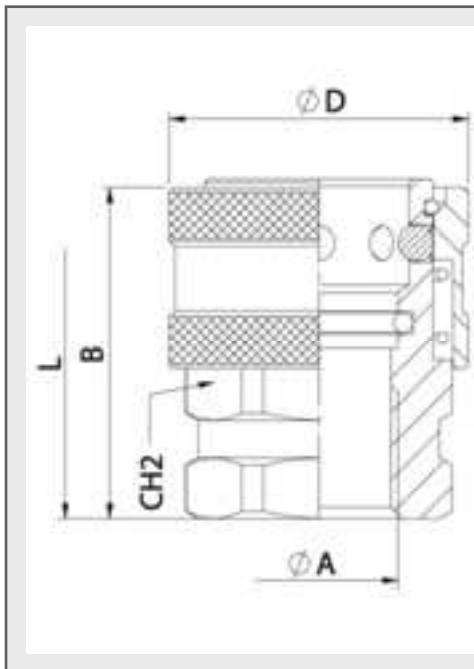

FEMALE (<i>CARBON ST.</i>)							
DN	ØA	CH2	B	ØD	L	REF.	
06	¼" BSP	22	35	29,50	45,10	140.12011AB	700 Bar
10	⅜" BSP	27	38	34	48,50	140.12012AC	600 Bar
13	½" BSP	32	45	39,50	55,50	140.12013AD	500 Bar



140 SERIES

CVF

PLUGS &
CAPS





DIN SERIES PLUGS/ CAPS have been designed to protect FEMALE (coupler) or MALE (nipple) parts while they are disconnected.
They have been manufactured according to ISO 5675 norm, DN13 size meets also ISO7241-A requirements

MODEL STRUCTURE
For plugs and caps

Example;

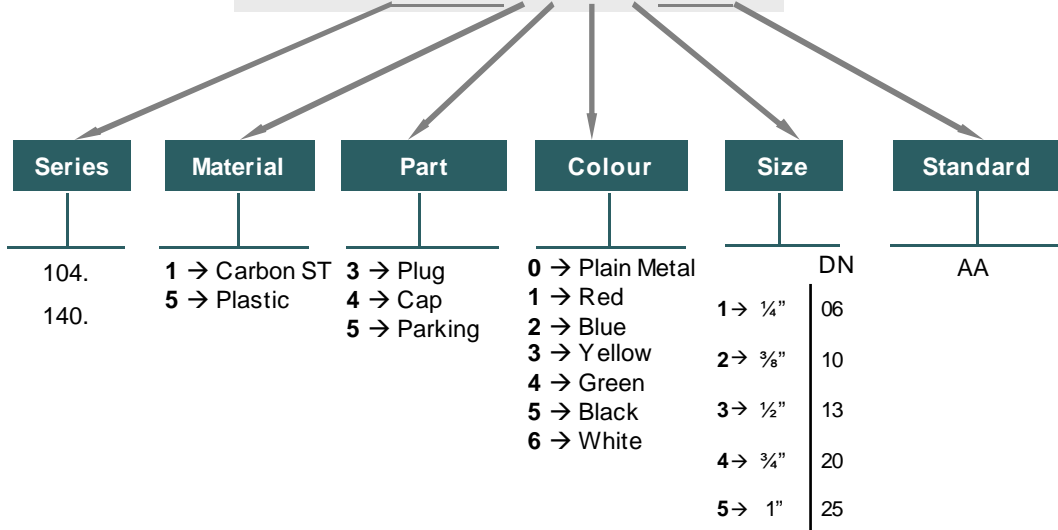
104.5353 AA





PLUG						
DN	RED	BLUE	YELLOW	GREEN	BLACK	WHITE
06	*	*	*	*	104.5351AA	*
10	*	*	*	*	104.5352AA	*
13	*	*	*	*	101.5353AA	*
20	*	*	*	*	104.5354AA	*
25	*	*	*	*	104.5355AA	*



CAP						
DN	RED	BLUE	YELLOW	GREEN	BLACK	WHITE
06	*	*	*	*	104.5451AA	*
10	*	*	*	*	104.5452AA	*
13	*	*	*	*	101.5453AA	*
20	*	*	*	*	104.5454AA	*
25	*	*	*	*	104.5455AA	*

* NOT AVAILABLE





190 SERIES RBP



Designed for low working pressure up to 35Bar.
Only available without valve (free-flow)

• Materials

Brass DIN-EN 12164

Seals: Silicone

Balls: *AISI 316W 14401*

Springs: *AISI302 DIN 17224*

• Working temperature (Seals)

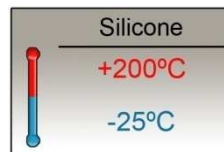

• **Applications:** Designed for Hot water Applications according to European Directive 97.23EC
Special for American market

• **Sectors:** Cooling system for moulds

MODEL STRUCTURE

Example;

190.41001 AN

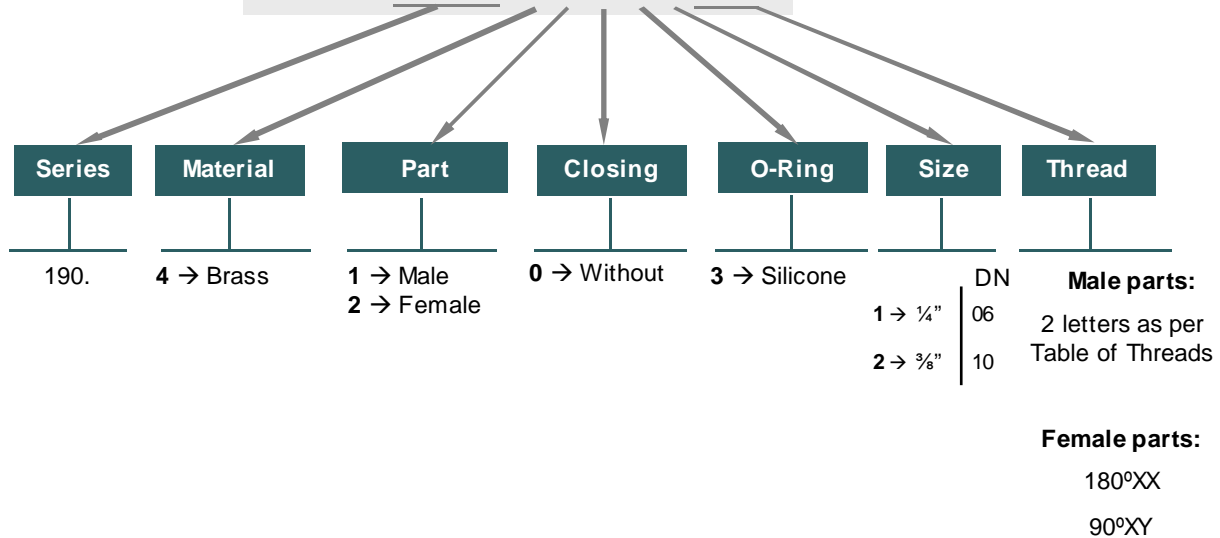

190-1





190 SERIES RBP



MALE						
DN	ØA	CH1	ØF	ØP	L	REF.
2/38	1/4" BSP M.	14	9,60	6	26	190.41001AM
3/17	1/4" BSP M.					190.41002AM
	3/8" BSP M.	27	13,30	8	31	190.41002AN

MALE						
DN	ØA	CH1	ØF	ØP	L	REF.
2/38	1/4" BSP M.	19	9,60	6	26	190.41001AB
3/17	1/4" BSP	17	13,30	8	31	190.41002AB
	3/8" BSP M.	27			34	190.41002AC

FEMALE						
DN	ØD	B	ØC	ØP	L	REF.
2/38	17	56	10	6	71,50	190.42031XX
3/17	23,50	57	13,30	8	82	190.42032XX

FEMALE							
DN	ØD	B1	B2	ØC	ØP	L	REF.
2/38	*	*	*	*	*	*	190.42031XY
3/17	24	42	48	13,30	8	60	190.42032XY



201 SERIES VCR



Designed for elevation systems on trucks.
Reduced drop pressure.
Poppet Valve closing system.

• Materials

Carbon Steel EN10277-3

Seals: NBR, Viton or EPDM

Springs: Carbon Steel DIN 17233/84(B)

• Working temperature (Seals)

	NBR	Viton	EPDM
	+100°C	+200°C	+150°C
	-30°C	-10°C	-40°C

• **Applications:** Designed for Oil hydraulic Applications according to European Directive 97.23.EC Special for American market

• Sectors: Industrial



• **Equivalence:** FASTER CVE
EDBRO

MODEL STRUCTURE

Example;

201.11114AE

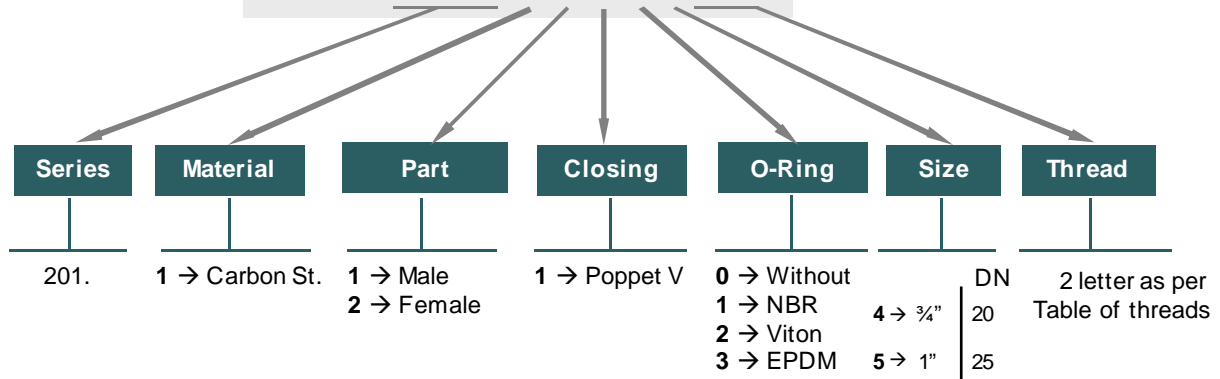



201-1





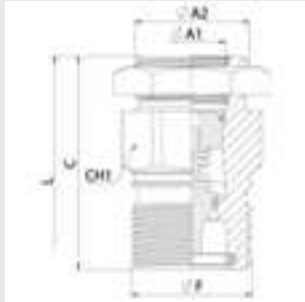

201 SERIES VCR

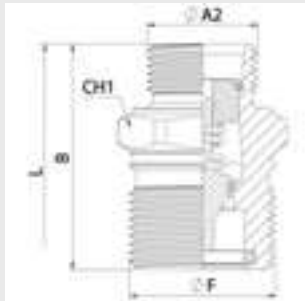

MALE								
DN	ØA1	ØA2	CH1	C	ØF	L	REF.	
20	¾" BSP	1 ¼"	46	78	44	138	201.11114AE	350 Bar
25	1" BSP	BSP	55	83	53,60	148	201.11115AF	300 Bar



MALE								
DN	ØA2	CH1	B	ØF	L	REF.		
20	1" BSP	46	68	44	118,50	201.11114AQ	350 Bar	

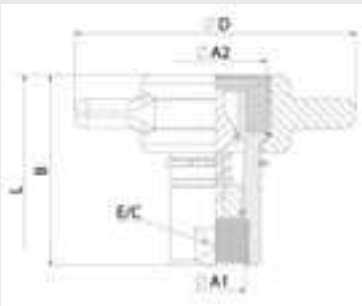

FEMALE								
DN	ØA1	ØA2	E/C	B	ØD	L	REF.	
20	¾" BSP	41,50	33	78	115	138	201.12114AE	350 Bar
25	1" BSP	51	40	83	115	148	201.12115AF	300 Bar

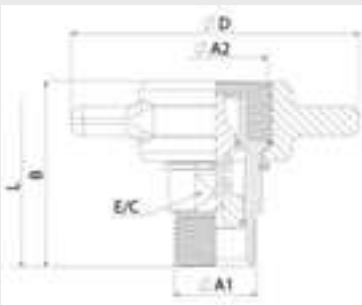

FEMALE								
DN	ØA1	E/C	ØA2	B	ØD	L	REF.	
20	1" BSP	33	41,50	74	115	118,50	201.12114AQ	350 Bar



201 SERIES VCR



TECHNICAL DATA

DN	Rated Flow	Min Burst Pressure (bar)			Max. Working Pressure
		Male	Female	Coupled	
20	120 l/m	1100	1300	1325	350 bar
25	160 l/m	1200	900	1325	300 bar

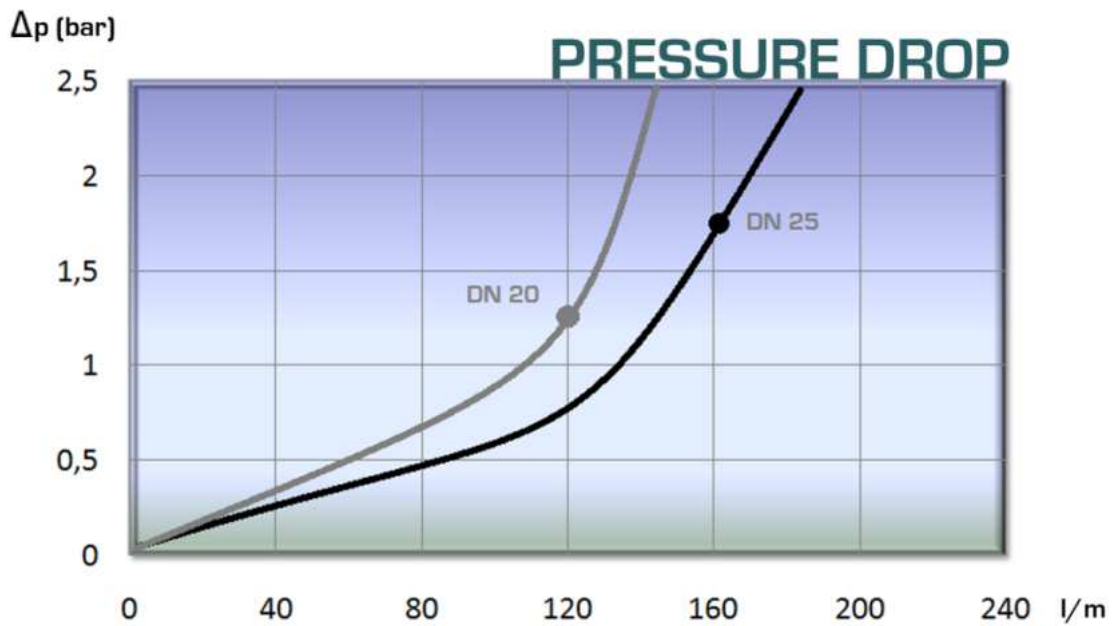

201-3





201 SERIES VCR

PLUGS &
CAPS



MODEL STRUCTURE

For plugs/caps and parking parts

Example;

201.6304 AA

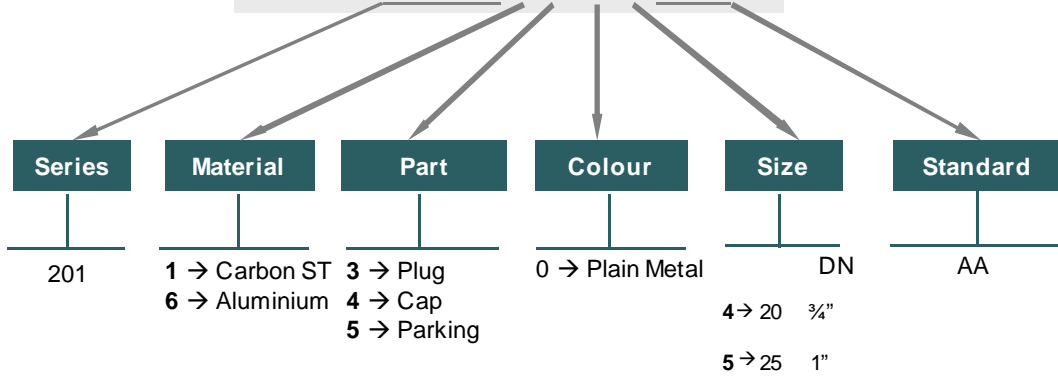
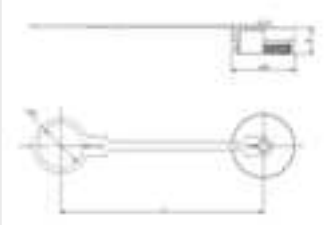
DN	REF.	ØA	L	B	ØD
20	201.6304AA	50	200	25	37,5
25	201.6305AA	60	191	25	42

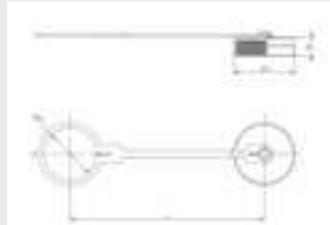

DN	REF.	ØA	L	B	ØD
20	201.6404AA	48	191	13	42
25	201.6405AA	60	191	18	52

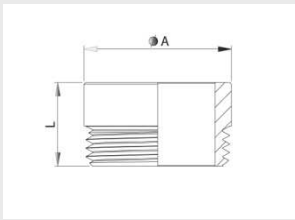

DN	REF.	ØA	L
20	201.1504AA	45	25
25	201.1505AA	55	25



202 SERIES HPA

Designed for cylinders, hand pumps and similar high hydraulic applications.
Ball or Poppet valve closing system available.
NPTF Threads. Other threads upon request.

• Materials

	CARBON STEEL	STAINLESS STEEL
Body	Carbon Steel EN-10277-3	AISI 316L
Seals	NBR, Viton or EPDM	NBR, Viton or EPDM
Balls	AISI 1010/1015	AISI316 W. 14401
Springs	Carbon Steel DIN 17233/84(B)	AISI302 DIN 17224

• Working temperature (Seals)

	NBR	Viton	EPDM
	+100°C	+200°C	+150°C
	-30°C	-10°C	-40°C

• **Applications:** Designed for Oil hydraulic Applications according to European Directive 97.23.EC

• Equivalence:

ENERPAC C-604

CEJN 230

PARKER 3000

• Sectors: Industrial

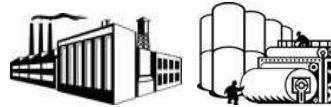

MODEL STRUCTURE

Example;

202. 12242 BN

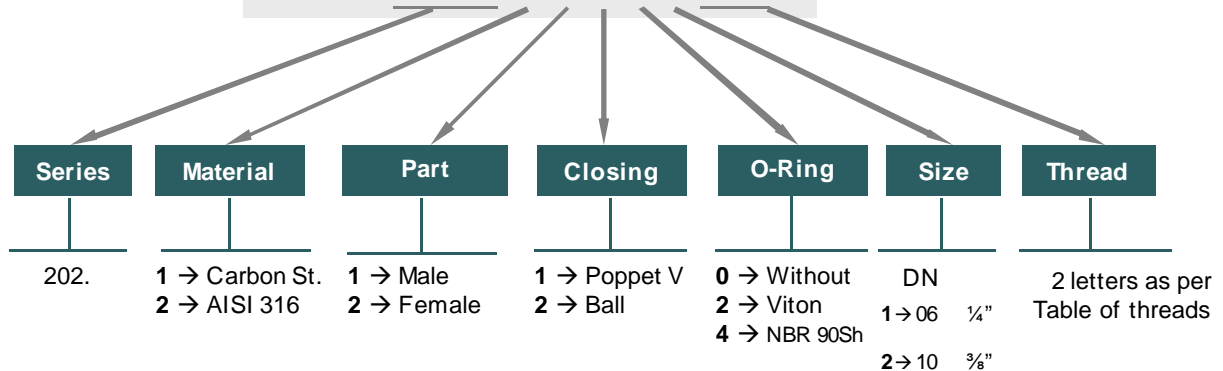

202-1





202 SERIES

HPA POPPET VALVE

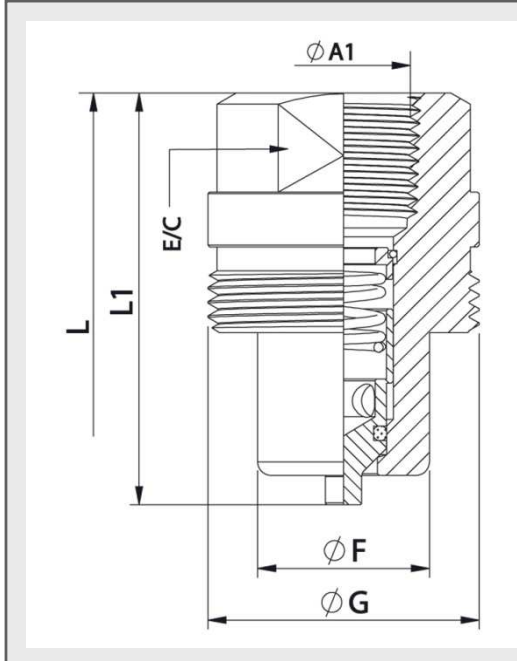

STANDARD MALE MODELS

DN	$\phi A1$	REF.		E/C	ϕG	L1	ϕF	L
06	1/4" NPTF	202.11141BB	1200Bar	*	*	*	*	*
10	3/8" NPTF	202.11142BC	1200Bar	24	1 3/16" UN	38,88	18,99	72,75

STAINLESS STEEL MALE MODELS

DN	$\phi A1$	REF.		E/C	ϕG	L1	ϕF	L
06	1/4" NPTF	202.21121BB	1200Bar	*	*	*	*	*
10	3/8" NPTF	202.21122BC	1200Bar	24	1 3/16" UN	42,50	18,99	72,75

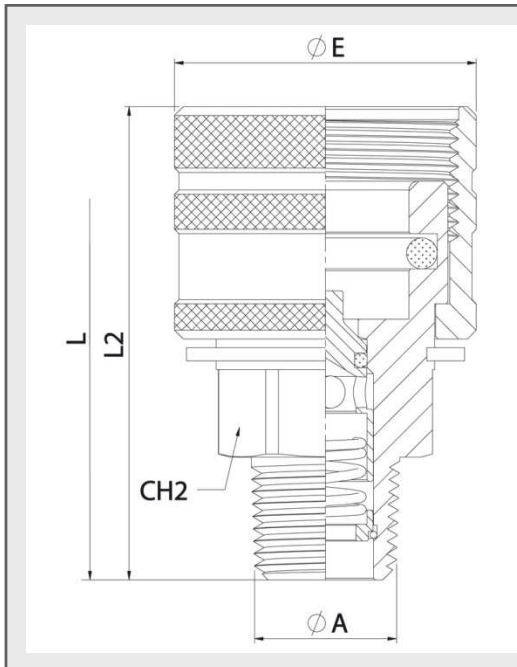

STANDARD FEMALE MODELS

DN	ϕA	REF.		CH2	L2	ϕE	L
06	1/4" NPTF M.	202.12141BM	1200Bar	*	*	*	*
10	3/8" NPTF M.	202.12142BN	1200Bar	22	45,50	34,50	72,75

STAINLESS STEEL FEMALE MODELS

DN	ϕA	REF.		CH2	L2	ϕE	L
06	1/4" NPTF M.	202.22121BM	1200Bar	*	*	*	*
10	3/8" NPTF M.	202.22122BN	1200Bar	22	45,50	34,50	72,75



202 SERIES

HPA BALL VALVE

BALL VALVE

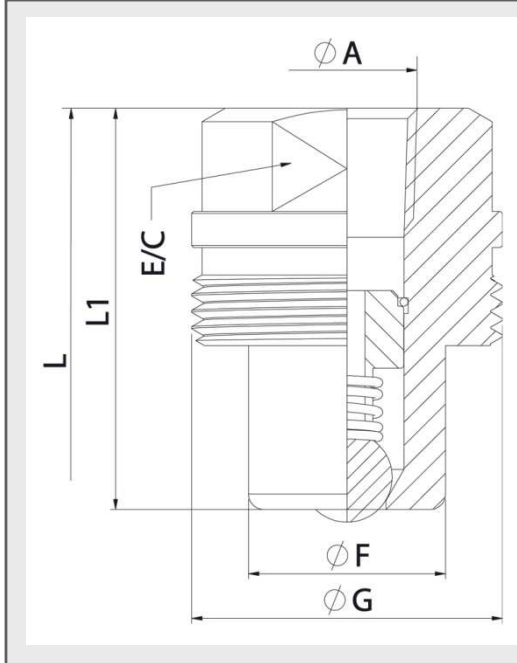

STANDARD MALE MODELS

DN	ØA	REF.		E/C	ØG	L1	ØF	L
06	1/4" NPTF	202.11201BB	700Bar	19	1" UN	34	15,85	75,5
10	3/8" NPTF	202.11202BC	700Bar	24	1 3/16" UN	38,88	18,99	87,14

STAINLESS STEEL MALE MODELS

DN	ØA	REF.		E/C	ØG	L1	ØF	L
06	1/4" NPTF	202.21201BB	700Bar	19	1" UN	34	15,85	75,5
10	3/8" NPTF	202.21202BC	700Bar	24	1 3/16" UN	38,88	18,99	87,14

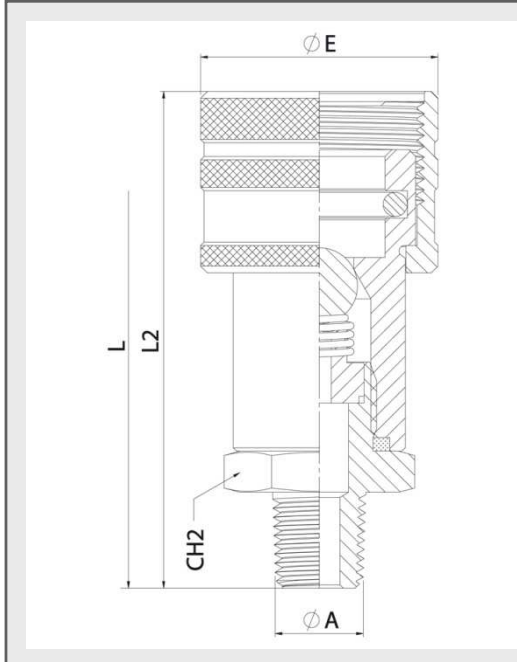

STANDARD FEMALE MODELS

DN	ØA	REF.		CH2	L2	ØD	L
06	1/4" NPTF M.	202.12241BM	700Bar	19	53	30	75,5
10	3/8" NPTF M.	202.12242BN	700Bar	24	64	34,50	87,14

STAINLESS STEEL FEMALE MODELS

DN	ØA	REF.		CH2	L2	ØD	L
06	1/4" NPTF M.	202.22221BM	700Bar	19	53	30	75,5
10	3/8" NPTF M.	202.22222BN	700Bar	24	64	34,50	87,14



202 SERIES HPA

PLUGS
& CAPS

HPA SERIES PLUGS and CAPS have been designed to protect FEMALE (coupler) or MALE (nipple) parts while they are disconnected.

MODEL STRUCTURE

Example;

202.6302 AA

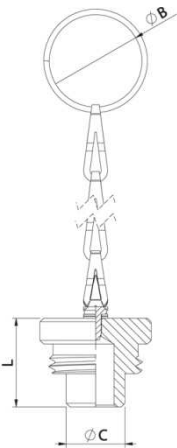
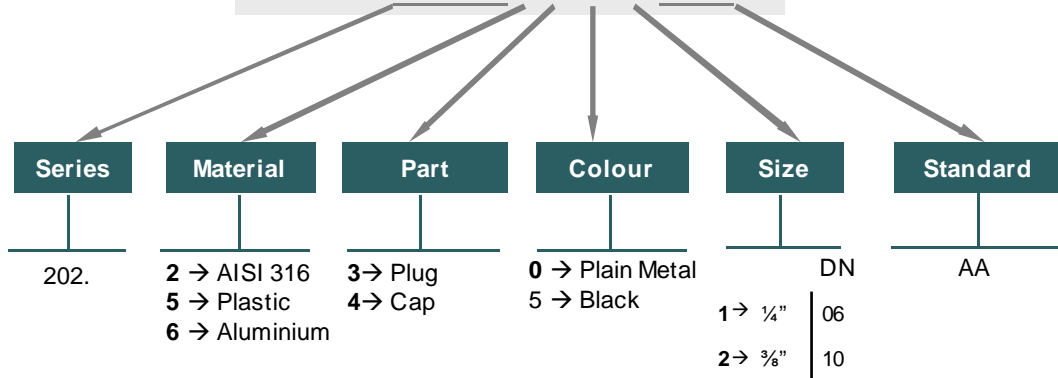

METAL PLUG

DN	ALUMINIUM	AISI 316	ØC	L	ØB
06	202.6301AA	202.2301AA	15,85	24	25
10	202.6302AA	202.2302AA	19	28	30

PLASTIC PLUG

DN	PLASTIC	ØC	L	ØB
06	202.5351AA	15,7	24	25
10	202.5352AA	19	28	30

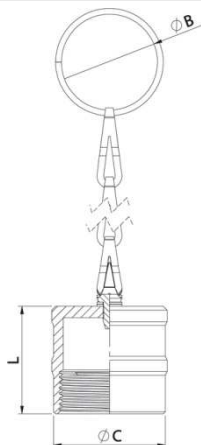

METAL CAP

DN	ALUMINIUM	AISI 316	ØC	L	ØB
06	202.6401AA	202.2401AA	29	28	25
10	202.6402AA	202.2402AA	34	34	30

PLASTIC PLUG

DN	PLASTIC	ØC	L	ØB
06	202.5451AA	15,7	24	25
10	202.5452AA	19	28	30



203 SERIES TGW



Designed for high pressure applications.
Poppet Valve closing system.
BSP, NPTF threads and other upon request.

• Materials

Carbon Steel *EN -10277-3, AISI 316 and AISI 303*

Seals: NBR, Viton or EPDM

Back-up-ring: PTFE

Springs: *Carbon Steel DIN 17233/84(B)*

• Working temperature (Seals)

	NBR	Viton	EPDM
	+100°C	+200°C	+150°C
	-30°C	-10°C	-40°C

• **Applications:** Designed for Oil hydraulic Applications according to European Directive 97.23EC
Special for American market

• Equivalence

GROMELLE 6000
TUTHILL 6000

• Sectors: Industrial



MODEL STRUCTURE

Example;

203.11115AF

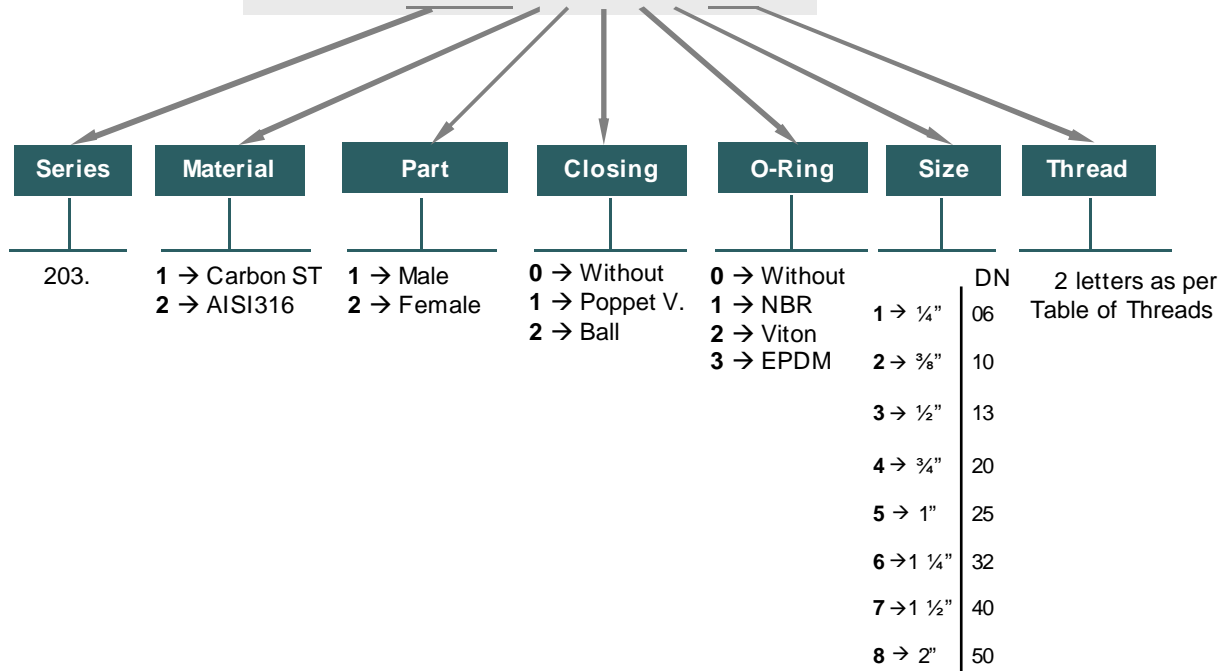

203-1





203 SERIES TGW



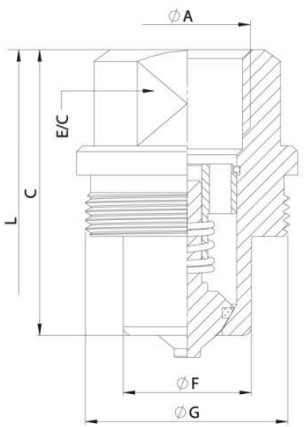

MALE					
DN	E/C	C	ØF	ØG	L
06	19	36	14,90	M27x1,5	72
10	22	40,50	18,95	M30x1,5	81
13	27	46	22	M35x1,5	92
20	35	56	28,95	M45x1,5	112
25	41	63	36	M54x1,5	126
32	58	75	49,80	M70x2	150
40	61	83,50	55	M78x2	167
50	71	118	69,40	M92x2	237

STANDARD MODELS				
DN	ØA	MALE	FEMALE	
06	¼" BSP	203.11111AB	203.12111AB	950Bar
	¼" NPTF	203.11111BB	203.12111BB	
10	⅜" BSP	203.11112AC	203.12112AC	750Bar
	⅜" NPTF	203.11112BC	203.12112BC	
13	½" BSP	203.11113AD	203.12113AD	750Bar
	½" NPTF	203.11113BD	203.12113BD	
20	¾" BSP	203.11114AE	203.12114AE	650Bar
	¾" NPTF	203.11114BE	203.12114BE	
25	1" BSP	203.11115AF	203.12115AF	450Bar
	1" NPTF	203.11115BF	203.12115BF	
32	1 ¼" BSP	203.11116AG	203.12116AG	450Bar
	1 ¼" NPTF	203.11116BG	203.12116BG	
40	1 ½" BSP	203.11117AH	203.12117AH	300Bar
	1 ½" NPTF	203.11117BH	203.12117BH	
50	2" BSP	203.11118AI	203.12118AI	300Bar
	2" NPTF	203.11118BI	203.12118BI	

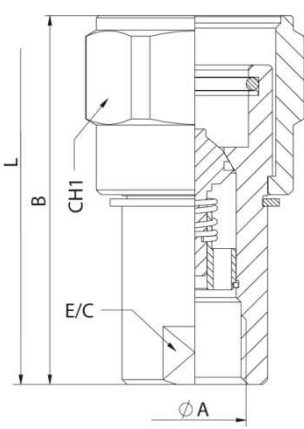

FEMALE				
DN	E/C	B	CH1	L
06	19	59	32	72
102	22	67	36	81
13	27	73,50	41	92
20	35	89,50	50	112
25	41	105,50	65	126
32	58	130,50	80	150
40	61	143,50	85	167
50	71	203,50	105	237



203 SERIES TGW



TECHNICAL DATA

DN	Rated Flow	Min Burst Pressure (bar)			Max. Working Pressure
		Male	Female	Coupled	
06	18 l/m	3650	3500	3800	950 bar
10	38 l/m	3000	2900	3000	750 bar
13	62 l/m	2950	3000	3000	750 bar
20	116 l/m	2520	2500	2600	650 bar
25	194 l/m	1800	1650	1800	450 bar
32	290 l/m	1700	1650	1800	450 bar
40	318 l/m	1100	1250	1200	300 bar
50	365 l/m	1100	1100	1200	300 bar

* Safety factor 1:4
Carbon Steel Models

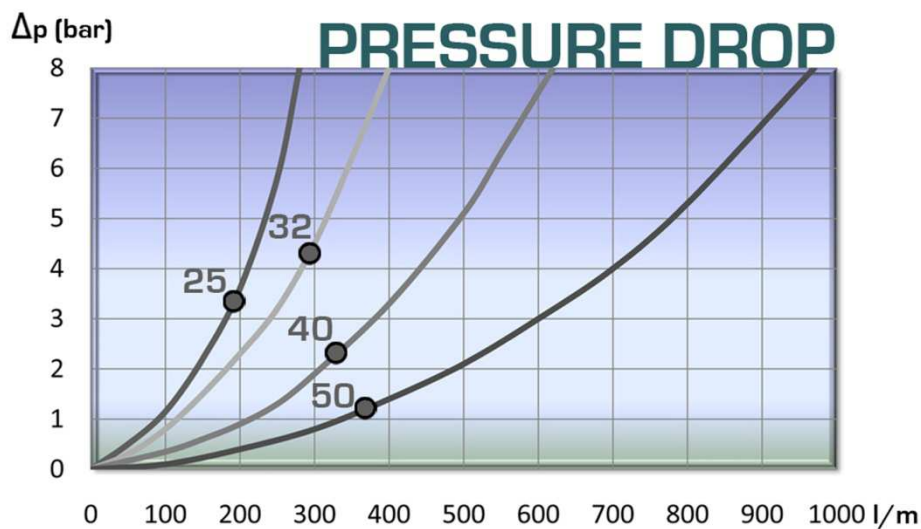
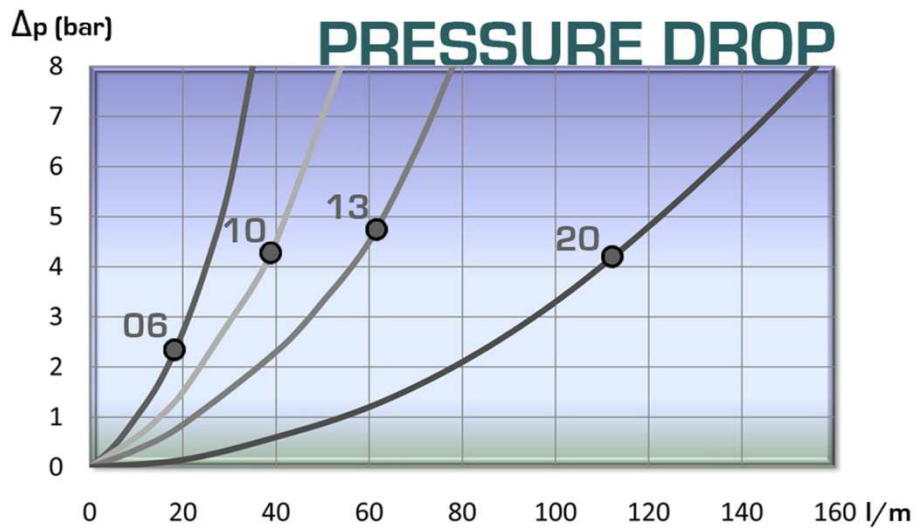

203-3





203 SERIES

TGW PLUGS & CAPS



TGW SERIES PLUGS, CAPS and have been designed to protect FEMALE (coupler) or MALE (nipple) parts while they are disconnected.

MODEL STRUCTURE

Example;

203.6404 AA

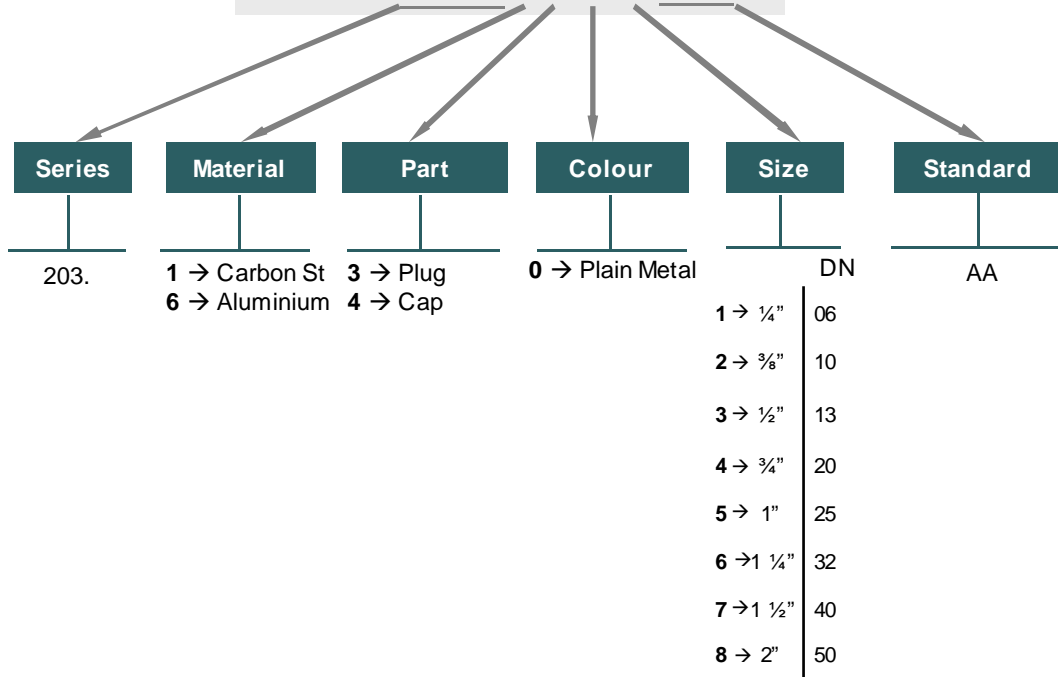

PLUG				
DN	REF.	ØA	L	ØB
06	203.6301AA	32	18,50	25
10	203.6302AA	35	20,50	30
13	203.6303AA	40	20,50	30
20	203.6304AA	50	25,50	42
25	203.6305AA	60	27	42
32	203.6306AA	75	39	50
40	203.6307AA	85	41	50
50	203.6308AA	99	43	50



CAP				
DN	REF.	ØA	L	ØB
06	203.6401AA	32	30	25
10	203.6402AA	35	37	30
13	203.6403AA	40	38	30
20	203.6404AA	50	46	42
25	203.6405AA	60	55	42
32	203.6406AA	75	77	50
40	203.6407AA	85	74	50
50	203.6408AA	100	121	50



204 SERIES AEV



Designed for Spanish market.
Poppet Valve closing system.
BSP threads and other available upon request.

• Materials

Carbon Steel *EN -10277-3*

Seals: NBR, Viton or EPDM

Springs: *Carbon Steel DIN 17233/84[B]*

• Working temperature (Seals)

	NBR	Viton	EPDM
	+100°C	+200°C	+150°C
	-30°C	-10°C	-40°C

- **Applications:** Designed for Oil hydraulic Applications according to European Directive 97.23.EC Special for American market

• Sectors: Agricultural



MODEL STRUCTURE

Example;

204.12113AD

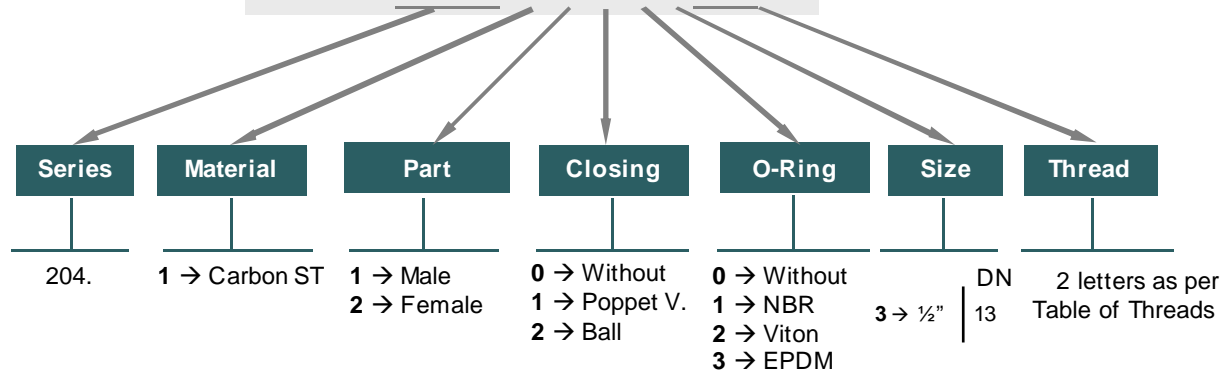

204-1





204 SERIES AEV

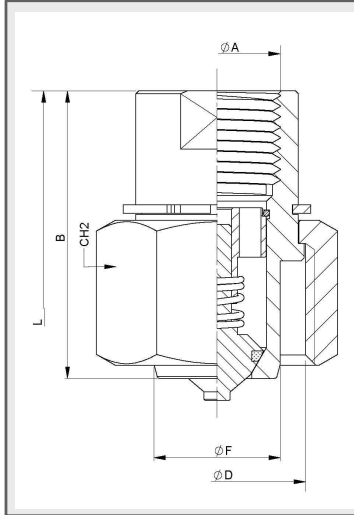

MALE

DN	ØA	E/C	CH2	B	ØF	ØD	L	REF.	
13	½" BSP	25	36	49,5	21,80	30,50	88	204.1113AD	400 Bar

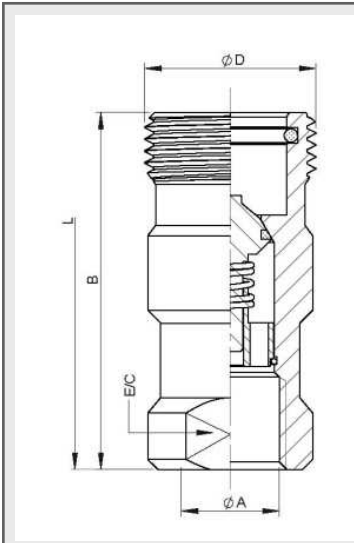

FEMALE

DN	ØA	E/C	B	ØD	L	REF.	
13	½" BSP	27	69,5	33	88	204.12113AD	400Bar



204 SERIES

AEV CAPS



MODEL STRUCTURE

Example;

204.1303 AA

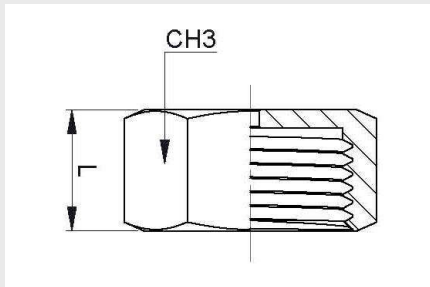
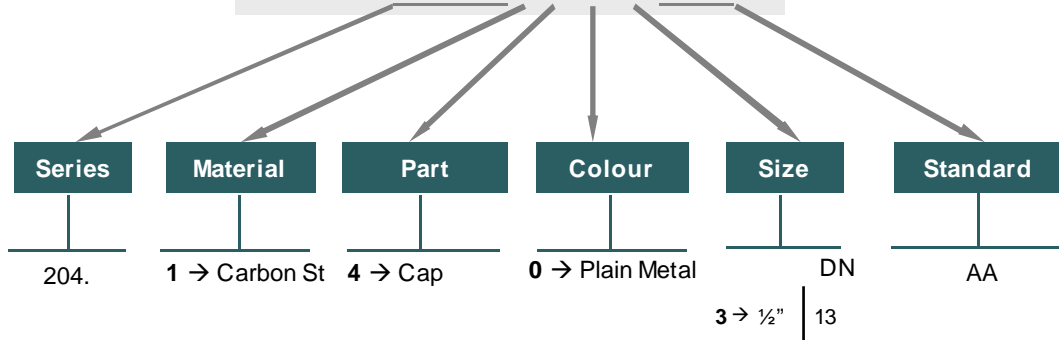

CAP			
DN	REF.	CH3	L
13	204.1303AA	36	20



205 SERIES STG

BSP / NPTF
DIN3852 / SAE



Poppet valve closing system
BSP, NPTF, DIN2353, DIN3852, SAE/ORB and other threads upon request.
AISI 316 available only by minimum quantities.

• Materials

Carbon Steel *EN-10277-3 / AISI 316L*

Seals: NBR, Viton or EPDM

Back-up-ring: PTFE

Springs: *Carbon Steel DIN 17233/84(B)*

• **Applications:** Designed for Oil hydraulic Applications according to European Directive 97.23.EC Special for American market

• Equivalence

FASTER CVV
ARGUS HD
VOSWINKEL HS

• Working temperature (Seals)

	NBR	Viton	EPDM
+	+100°C	+200°C	+150°C
-	-30°C	-10°C	-40°C

• **Sectors:** Industrial, Agricultural, Construction machinery.



MODEL STRUCTURE

Example;

205.12115AF

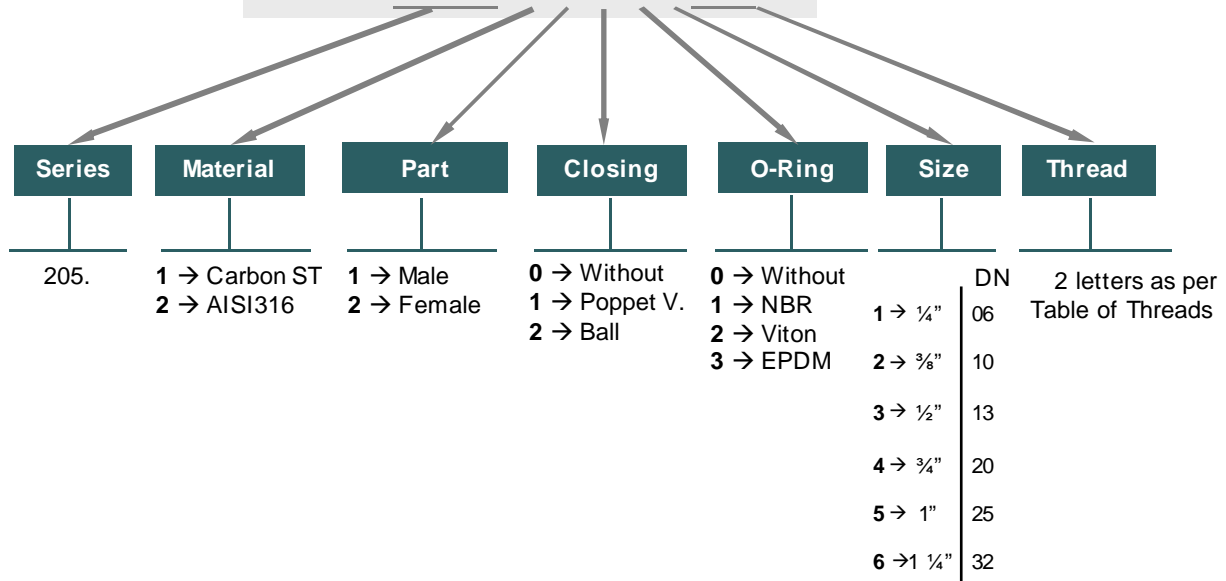

205-1





205 SERIES

STG

BSP / NPTF
DIN3852 / SAE

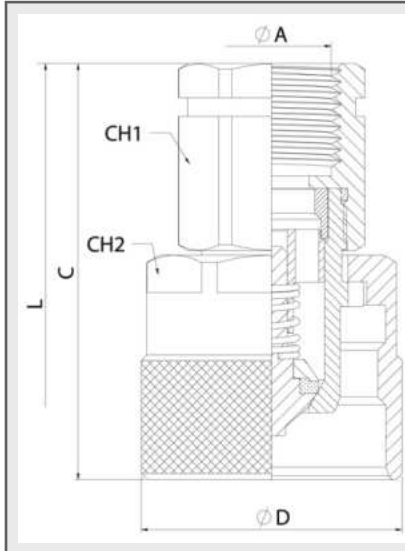

MALE						
DN	CH1	CH2	C	ØD	ØA	L
06	19	30	59,30	34	34	94
10	22	30	61,20	34	34	98
13	27	36	67,50	41,80	41,80	109
20	36	41	80	48	48	135
25	41	55	87,5	59,80	59,80	152
32	50	75	142	79,80	79,80	241,80

STANDARD MODELS				
DN	ØA	MALE	FEMALE	
06	1/4" BSP	205.11111AB	205.12111AB	450Bar
	1/4" NPTF	205.11111BB	205.12111BB	
	M14x1,5	205.11111NC	205.12111NC	
10	1/4" BSP	205.11112AB	205.12112AB	450Bar
	3/8" BSP	205.11112AC	205.12112AC	
	3/8" NPTF	205.11112BC	205.12112BC	
13	M16x1,5	205.11112ND	205.12112ND	400Bar
	3/8" BSP	205.11113AC	205.12113AC	
	1/2" BSP	205.11113AD	205.12113AD	
	1/2" NPTF	205.11113BD	205.12113BD	
	M18x1,5	205.11113NE	205.12113NE	
	M22x1,5	205.11113NG	205.12113NG	
20	3/4" -16ORB	205.11113GF	205.12113GF	400Bar
	7/8" -14ORB	205.11113GH	205.12113GH	
	3/4" BSP	205.11114AE	205.12114AE	
25	3/4" NPTF	205.11114BE	205.12114BE	300Bar
	M22x1,5	205.11114NG	205.12114NG	
	3/4" BSP	205.11115AE	205.12115AE	
32	1" BSP	205.11115AF	205.12115AF	300Bar
	1" NPTF	205.11115BF	205.12115BF	
	1 1/4" BSP	205.11116AG	205.12116AG	
32	1 1/4" NPTF	205.11116BG	205.12116BG	300Bar
	1 1/2" BSP	205.11116AH	205.12116AH	
	1 1/2" NPTF	205.11116BH	205.12116BH	

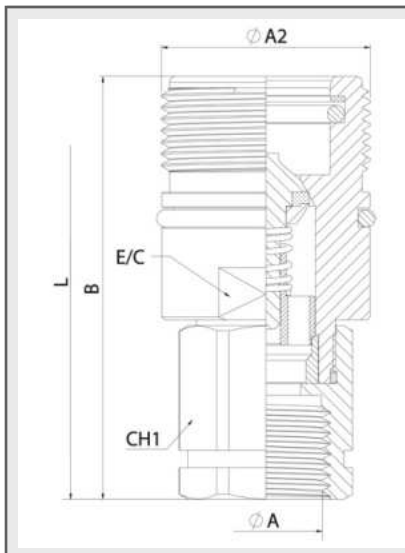

FEMALE						
DN	CH1	E/C	B	ØA2	ØA	L
06	19	22	60	Rd 24x2	34	94
10	22	24	64	Rd 28x2	34	98
13	27	32	70	Rd 36x2	41,80	109
20	36	36	86	Rd 42x2	48	135
25	41	41	100	Rd 48x3	59,80	152
32	50	60	150	Rd 70x3	79,80	241,80

SPECIAL EDITION

For request with hexagonal nut use reference 215 instead of 205.



205 SERIES STG

BSP / NPTF
DIN3852 / SAE



TECHNICAL DATA

DN	Rated Flow	Min Burst Pressure (bar)			Max. Working Pressure *
		Male	Female	Coupled	
06	12 l/min	1580	1500	1800	450 bar
10	32 l/min	1750	1680	1800	450 bar
13	75 l/min	1580	1500	1600	400 bar
20	145 l/min	1520	1400	1600	400 bar
25	255 l/min	1200	1150	1200	300 bar
32	440 l/min	1450	1520	1650	410 bar

* Safety factor 1:4
Carbon Steel Models

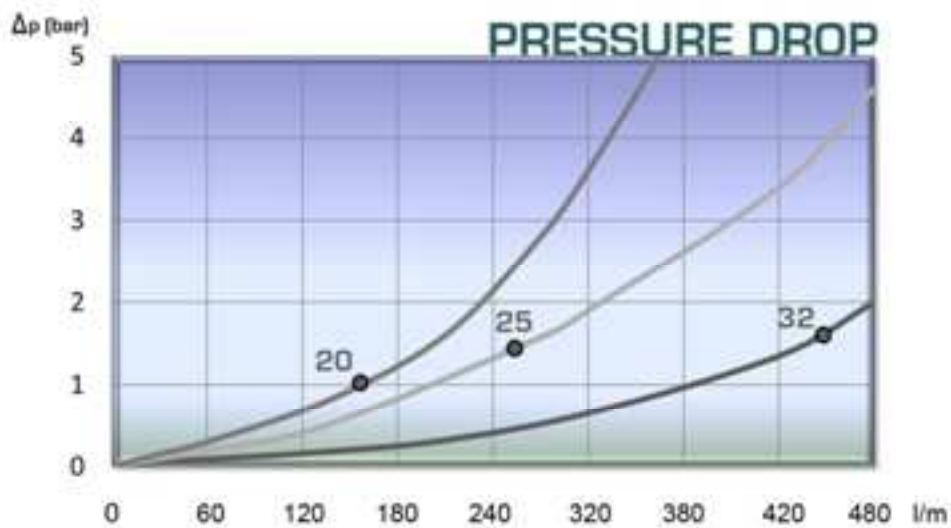

205-3



205 SERIES

STG

DIN2353

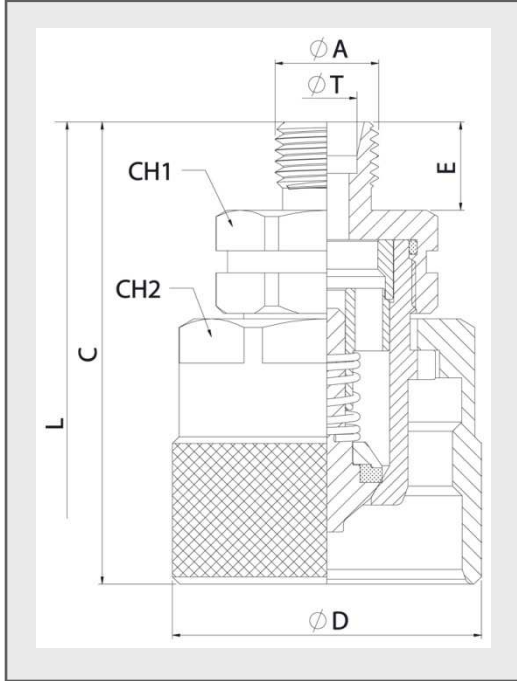

STANDARD MALE MODELS										
DN	ØA	ØT	REF.		CH1	CH2	C	ØD	E	L
06	M12x1,5	6L	205.11111JB	450Bar	19	30	49,30	34	12	93,80
	M14x1,5	8L	205.11111JC							
	M18x1,5	12L	205.11112JE							
10	M14x1,5	8L	205.11112JC	450Bar	22	30	60,20	34	12	96
	M16x1,5	10L	205.11112JD							
	M16x1,5	8S	205.11112KD							
	M18x1,5	10S	205.11112KE							
	M20x1,5	12S	205.11112KF							
	M14x1,5	8L	205.11113JC							
13	M16x1,5	10L	205.11113JD	400Bar	27	36	63,50	41,80	12	101
	M18x1,5	12L	205.11113JE							
	M22x1,5	15L	205.11113JG							
	M26x1,5	18L	205.11113JI							
	M18x1,5	10S	205.11113KE							
	M20x1,5	12S	205.11113KF							
	M22x1,5	14S	205.11113KG							
	M24x1,5	16S	205.11113KH							
	M18x1,5	12L	205.11114JE							
	M22x1,5	15L	205.11114JG							
20	M26x1,5	18L	205.11114JI	400Bar	36	41	72	48	12	119
	M30x2	22L	205.11114JJ							
	M22x1,5	14S	205.11114KG							
	M24x1,5	16S	205.11114KH							
	M30x2	20S	205.11114KJ							
	M26x1,5	18L	205.11115JI							
25	M30x2	22L	205.11115JJ	300Bar	41	55	70,50	59,80	12	146
	M36x2	28L	205.11115JK							
	M45x2	35L	205.11115JM							
	M30x2	20S	205.11115KJ							
	M36x2	25S	205.11115KK							
	M42x2	30S	205.11115KL							
	M52x2	38S	205.11115KN							
	M42x2	30S	205.11116KL							
32	M42x2	30S	205.11116KL	300Bar	55	75	143	79,80	20	243,80
	M52x2	38S	205.11116KN							

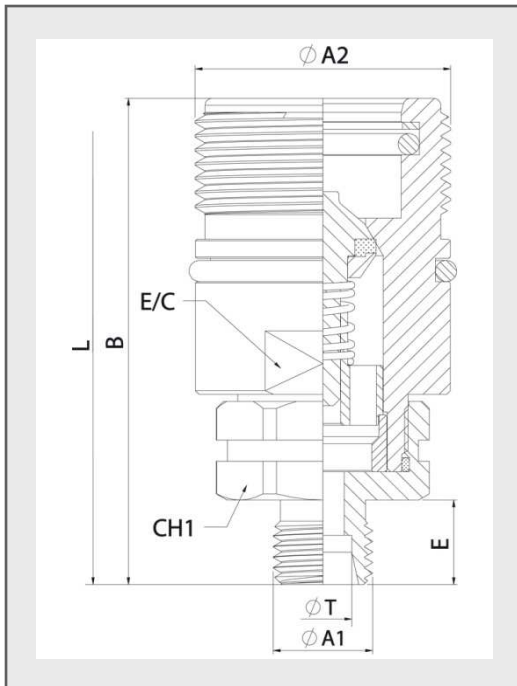

STANDARD FEMALE MODELS										
DN	ØA	ØT	REF.		CH1	E/C	B	ØA2	E	L
06	M12x1,5	6L	205.12111JB	450Bar	19	22	59	Rd 24x2	12	93,80
	M14x1,5	8L	205.12111JC							
	M18x1,5	12L	205.12112JE							
10	M14x1,5	8L	205.12112JC	450Bar	22	24	63	Rd 28x2	12	96
	M16x1,5	10L	205.12112JD							
	M16x1,5	8S	205.12112KD							
	M18x1,5	10S	205.12112KE							
	M20x1,5	12S	205.12112KF							
	M14x1,5	8L	205.12113JC							
13	M16x1,5	10L	205.12113JD	400Bar	27	32	66	Rd 36x2	12	101
	M18x1,5	12L	205.12113JE							
	M22x1,5	15L	205.12113JG							
	M26x1,5	18L	205.12113JI							
	M18x1,5	10S	205.12113KE							
	M20x1,5	12S	205.12113KF							
	M22x1,5	14S	205.12113KG							
	M24x1,5	16S	205.12113KH							
	M18x1,5	12L	205.12114JE							
	M22x1,5	15L	205.12114JG							
20	M26x1,5	18L	205.12114JI	400Bar	36	36	78	Rd 42x2	12	119
	M30x2	22L	205.12114JJ							
	M22x1,5	14S	205.12114KG							
	M24x1,5	16S	205.12114KH							
	M30x2	20S	205.12114KJ							
	M26x1,5	18L	205.12115JI							
25	M30x2	22L	205.12115JJ	300Bar	41	41	91	Rd 48x3	12	146
	M36x2	28L	205.12115JK							
	M45x2	35L	205.12115JM							
	M30x2	20S	205.12115KJ							
	M36x2	25S	205.12115KK							
	M42x2	30S	205.12115KL							
	M52x2	38S	205.12115KN							
	M42x2	30S	205.12116KL							
32	M42x2	30S	205.12116KL	300Bar	55	60	151	Rd 70x3	20	243,80
	M52x2	38S	205.12116KN							





205 SERIES

STG

DIN2353

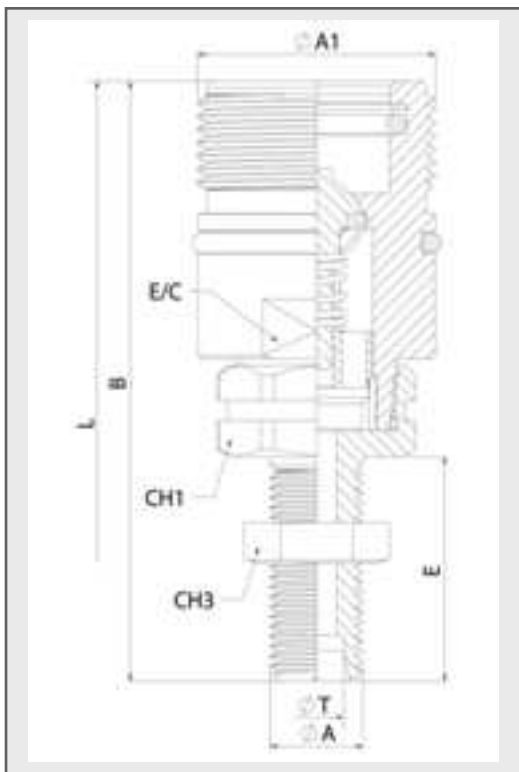
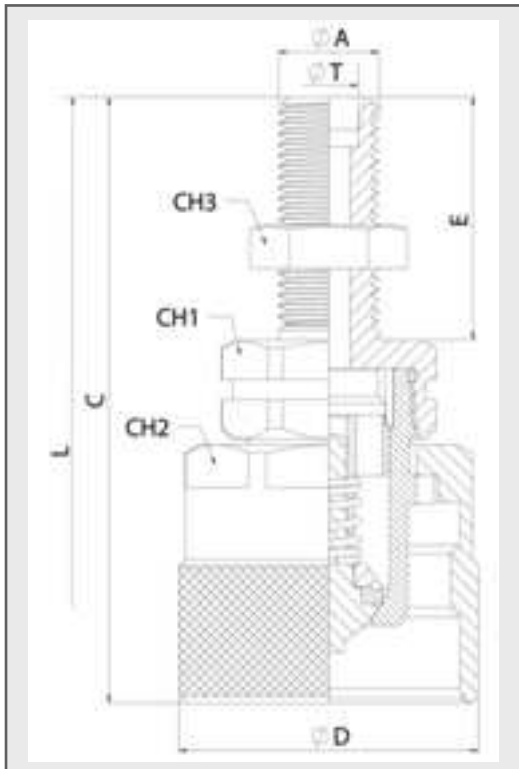

STANDARD MALE MODELS

DN	ØA	ØT	REF.		CH1	CH2	CH3	C	ØD	E	L	
06	M12x1,5	6L	205.11111LB	450Bar	19	30	19	71,30	34	25	128,80	
	M14x1,5	8L	205.11111LC					80,30		34	146,80	
	M14x1,5	8L	205.11112LC					19		81,50	34	151,50
10	M16x1,5	10L	205.11112LD	450Bar	22	30	22	65,20	34	26	127,50	
	M16x1,5	8S	205.11112MD					75,20		27	138,20	
	M18x1,5	10S	205.11112ME									
13	M20x1,5	12S	205.11112MF	400Bar	27	36	30	86,50	41,80	33	157,50	
	M14x1,5	8L	205.11113LC					19		85,50	34	156,50
	M16x1,5	10L	205.11113LD					22		86,50	35	157,50
20	M18x1,5	12L	205.11113LE	400Bar	36	41	30	75,50	48	24	136,50	
	M22x1,5	15L	205.11113LG					27		86,50	35	157,50
	M26x1,5	18L	205.11113LI					30				
25	M18x1,5	10S	205.11113ME	300Bar	41	55	36	75,50	59,80	24	136,50	
	M20x1,5	12S	205.11113MF					22		86,50	35	157,50
	M22x1,5	14S	205.11113MG					27				
32	M24x1,5	16S	205.11113MH	300Bar	50	75	50	86,50	143	30	199,50	
	M18x1,5	12I	205.11114LE					24		86	26	157
	M22x1,5	15L	205.11114LG					27		93	33	171
20	M26x1,5	18L	205.11114LI	400Bar	36	41	30	93	48	33	171	
	M30x2	22L	205.11144LJ					36		94	34	173
	M24x1,5	16S	205.11114MH					30		89	29	173
25	M30x2	20S	205.11114MJ	300Bar	41	55	36	96	59,80	36	163	
	M26x1,5	18L	205.11115LI					30		99,50	33	185,50
	M30x2	22L	205.11115LJ					36		100,50	34	187,50
25	M36x2	28L	205.11115LK	300Bar	41	55	41	100,50	59,80	34	187,50	
	M45x2	35L	205.11115LM					55		102,50	36	191,50
	M30x2	20S	205.11115MJ					36		101,50	35	189,50
32	M36x2	25S	205.11115MK	300Bar	50	75	50	104,50	143	38	195,50	
	M42x2	30S	205.11115ML					50		106,50	40	199,50
	M52x2	38S	205.11115MN					65		106,50	40	199,50
32	M42x2	30S	205.11116ML	300Bar	50	75	50	143	40	284		

STANDARD FEMALE MODELS

DN	ØA	ØT	REF.		CH1	E/C	CH3	B	ØA1	E	L	
06	M12x1,5	6L	205.12111LB	450Bar	19	22	19	72	Rd 24x2	25	128,80	
	M14x1,5	8L	205.12111LC					81		34	146,80	
	M14x1,5	8L	205.12112LC					19		85	34	151,50
10	M16x1,5	10L	205.12112LD	450Bar	22	24	22	77	Rd 28x2	26	127,50	
	M16x1,5	8S	205.12112MD					780		27	138,20	
	M18x1,5	10S	205.12112ME									
13	M20x1,5	12S	205.12112MF	400Bar	27	32	30	88	Rd36x2	34	156,50	
	M14x1,5	8L	205.12113LC					19		88	35	157,50
	M16x1,5	10L	205.12113LD					22		89	35	157,50
20	M18x1,5	12L	205.12113LE	400Bar	36	36	30	78	Rd 42x2	24	136,50	
	M22x1,5	15L	205.12113LG					27		88	35	157,50
	M26x1,5	18L	205.12113LI					30				
25	M18x1,5	10S	205.12113ME	300Bar	41	41	36	78	Rd 48x3	24	136,50	
	M20x1,5	12S	205.12113MF					22		88	35	157,50
	M22x1,5	14S	205.12113MG					27				
32	M24x1,5	16S	205.12113MH	300Bar	50	60	50	88	171	30	199,50	
	M18x1,5	12I	205.12114LE					24		92	26	157
	M22x1,5	15L	205.12114LG					27		93	33	171
20	M26x1,5	18L	205.12114LI	400Bar	36	36	30	93	Rd 42x2	33	171	
	M30x2	22L	205.12114LJ					36		99	34	173
	M24x1,5	16S	205.12114MH					30		100	29	173
25	M30x2	20S	205.12114MJ	300Bar	41	41	36	95	Rd 48x3	36	163	
	M26x1,5	18L	205.12115LI					30		112	33	185,50
	M30x2	22L	205.12115LJ					36		113	34	187,50
32	M36x2	28L	205.12115LK	300Bar	50	60	50	113	171	34	187,50	
	M45x2	35L	205.12115LM					55		115	36	191,50
	M30x2	20S	205.12115MJ					36		114	35	189,50
25	M36x2	25S	205.12115MK	300Bar	50	60	50	117	171	38	195,50	
	M42x2	30S	205.12115ML					50		119	40	199,50
	M52x2	38S	205.12115MN					65		119	40	199,50
32	M42x2	30S	205.12116ML	300Bar	50	60	50	171	40	284		





205 SERIES STG

PLUGS
& CAPS



STG SERIES PLUGS, CAPS and have been designed to protect FEMALE (coupler) or MALE (nipple) parts while they are disconnected.

MODEL STRUCTURE

Example;

205.5414 AA

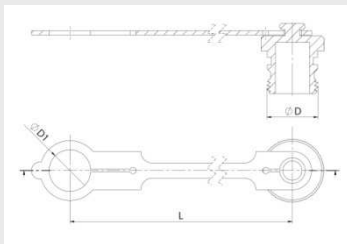
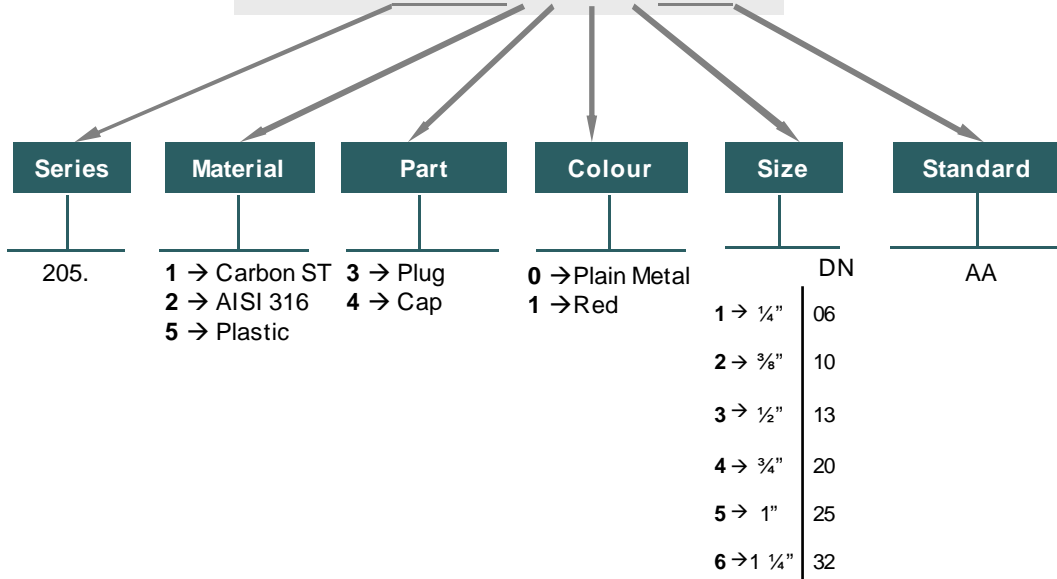

PLUG				
DN	REF.	ØD	ØD1	L
06	205.5311AA	Rd 24x2	20	90
10	205.5312AA	Rd 28x2	24	100
13	205.5313AA	Rd 36x2	29,50	135
20	205.5314AA	Rd 42x2	37	187
25	205.5315AA	Rd 48x3	41	145
32	205.5316AA	Rd 70x2	55	200

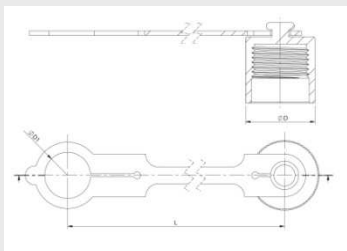

CAP				
DN	REF.	ØD	ØD1	L
06	205.5411AA	Rd 24x2	20	90
10	205.5412AA	Rd 28x2	24	100
13	205.5413AA	Rd 36x2	29,50	135
20	205.5414AA	Rd 42x2	37	187
25	205.5415AA	Rd 48x3	41	145
32	205.5416AA	Rd 70x2	55	200



206 SERIES

SRK

DIN 2353



DIN2353 and other threads available upon request.
AISI 316 available but only for minimum quantities.

• Materials

Carbon Steel *EN -10277-3 / AISI 316L*

Seals: NBR, Viton or EPDM

Back-up-ring: PTFE

Springs: *Carbon Steel DIN 17233/84(B)*

• **Applications:** Designed for Oil hydraulic Applications according to European Directive 97.23.EC

• **Equivalence:** Voswinkel Serie RS
Argus Serie RK

• Working temperature (Seals)

	NBR	Viton	EPDM
	+100°C	+200°C	+150°C
	-30°C	-10°C	-40°C

• **Sectors:** Industrial, Agricultural, Construction machinery.

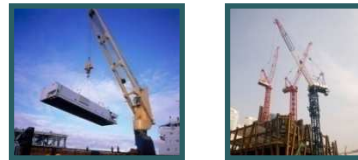

MODEL STRUCTURE

Example;

206.12115AF

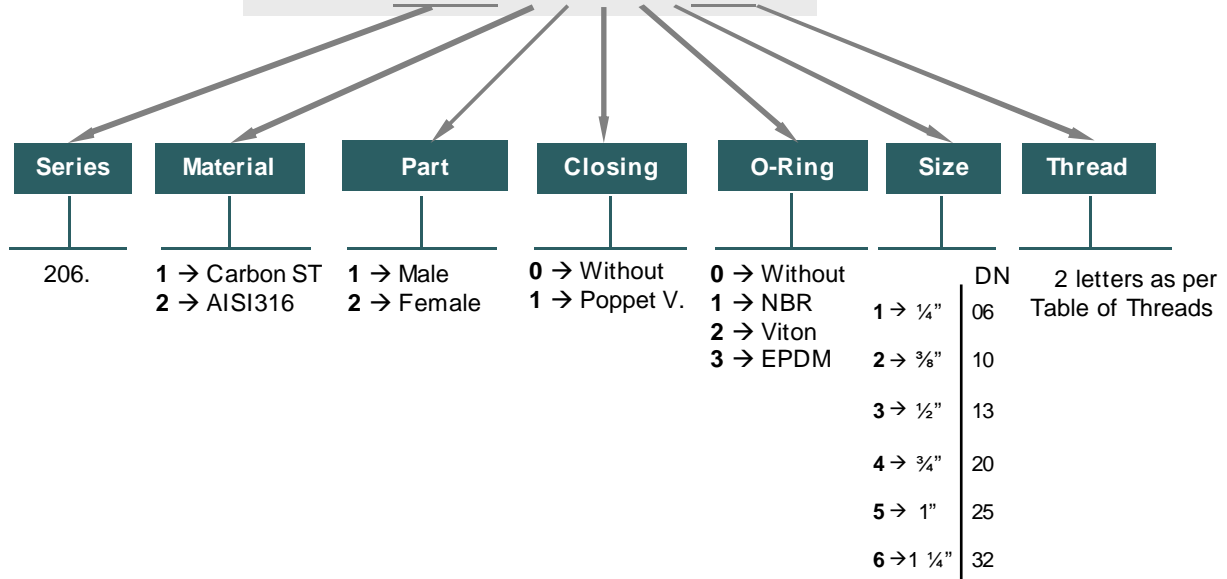

206-1







206 SERIES

SRK

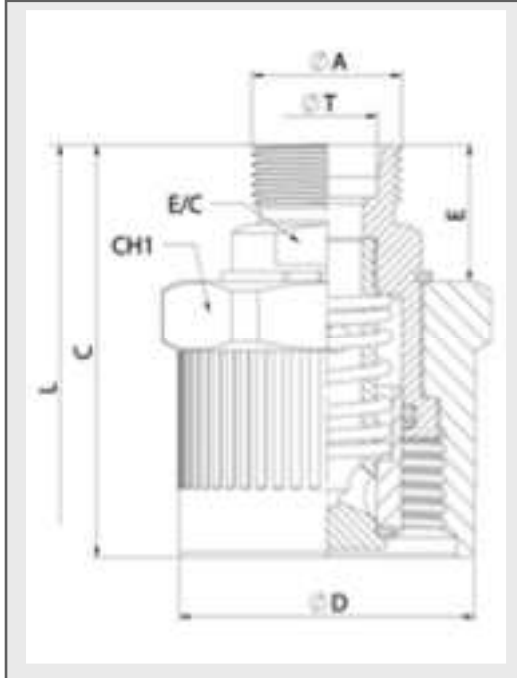
DIN 2353



STANDARD MALE MODELS

DN	ØA	ØT	REF.		CH1	E/C	C	ØD	E	L
10	M14x1,5	8L	206.11112JC	400 Bar	32	22	62,5	39	21,5	103,5
	M16x1,5	10L	206.11112JD							
	M18x1,5	12L	206.11112JE							
	M18x1,5	10S	206.11112KE							
	M20x1,5	12S	206.11112KF							
	M22x1,5	15L	206.11112JG							
	M24x1,5	16S	206.11112KH							
13	M18x1,5	12L	206.11113JE	300 Bar	46	24	70	45	20	119
	M22x1,5	15L	206.11113JG							
	M22x1,5	14S	206.11113KG							
	M24x1,5	16S	206.11113KH							
	M26x1,5	18L	206.11113JI							
20	M30x2	22L	206.11114JJ	320 Bar	60	32	83	59,1	27,4	140
	M30x2	20S	206.11114KJ							
	M36x2	25S	206.11114KK							
	M30x2	22L	206.11115JJ							
25	M30x2	20S	206.11115KJ	300 Bar	55	41	105	63,9	35	144
	M36x2	28L	206.11115JK							
	M36x2	25S	206.11115KK							
	M42x2	30S	206.11115KL							
32	M45x2	35L	206.11116JM	420 Bar	*	55	133	90	38	227
	M52x2	38S	206.11116KN							

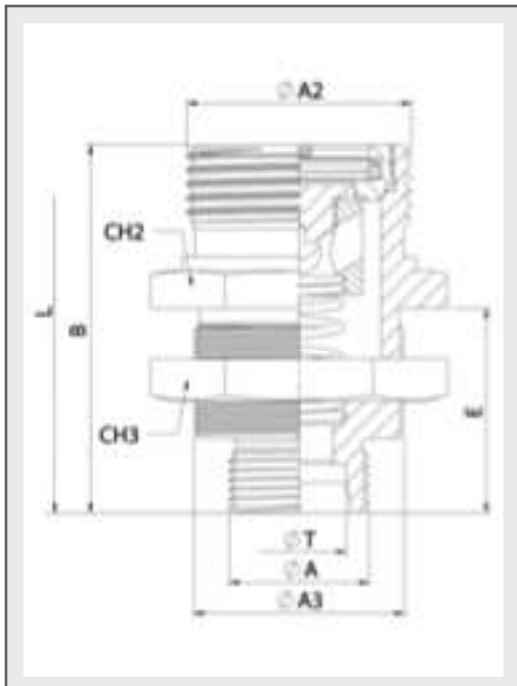

STANDARD FEMALE MODELS

DN	ØA	ØT	REF.		ØA2	ØA3	CH2	CH3	E	B	L
10	M14x1,5	8L	206.12112JC	400 Bar	Rd 32x3	M30x1	36	36	31	55	103,5
	M16x1,5	10L	206.12112JD								
	M18x1,5	12L	206.12112JE								
	M18x1,5	10S	206.12112KE								
	M20x1,5	12S	206.12112KF								
	M22x1,5	15L	206.12112JG								
	M24x1,5	16S	206.12112KH								
13	M22x1,5	14S	206.12113KG	300 Bar	Rd 36x3	M36x1	41	41	37,5	65	119
	M24x1,5	16S	206.12113KH								
	M26x1,5	18L	206.12113JI								
	M26x1,5	18L	206.12114JI								
	M30x2	22L	206.12114JJ								
20	M30x2	20S	206.12114KJ	320 Bar	Rd 48x3	M45x1,5	55	55	44	79	140
	M36x2	25S	206.12114KK								
	M30x2	22L	206.12115JJ								
	M30x2	20S	206.12115KJ								
25	M36x2	28L	206.12115JK	300 Bar	Rd 54x4	M54x1,5	55	60	46	89	144
	M36x2	25S	206.12115KK								
	M42x2	30S	206.12115KL								
	M45x2	35L	206.12116JM								
32	M52x2	38S	206.12116KN	420 Bar	Rd 79x4	*	55	133	90	38	227



206 SERIES SRK

DIN2353



TECHNICAL DATA					
DN	Rated Flow	Min Burst Pressure [bar]			Max. Working Pressure *
		Male	Female	Coupled	
10	29 l/min	1500	1580	1600	400 bar
13	72 l/min	1200	1150	1200	300 bar
20	135 l/min	1250	1300	1280	320 bar
25	250 l/min	1200	1150	1200	300 bar
32	430 l/min	1550	1600	1680	420 bar

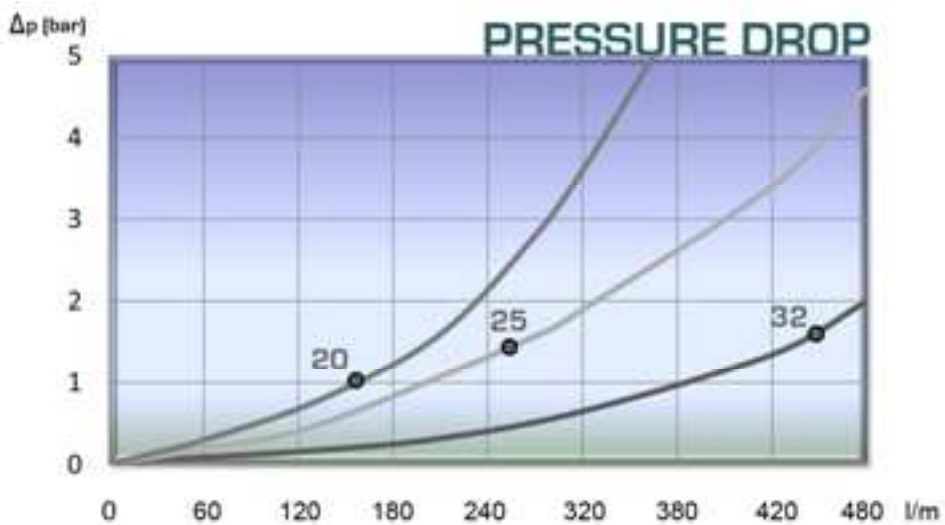



206 SERIES SRK

PLUGS
& CAPS



SRK SERIES PLUGS, CAPS and have been designed to protect FEMALE (coupler) or MALE (nipple) parts while they are disconnected.

MODEL STRUCTURE

Example;

206.6403 AA

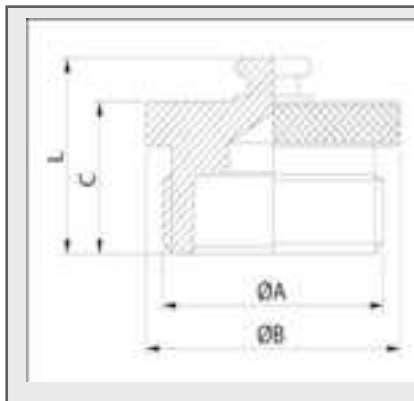
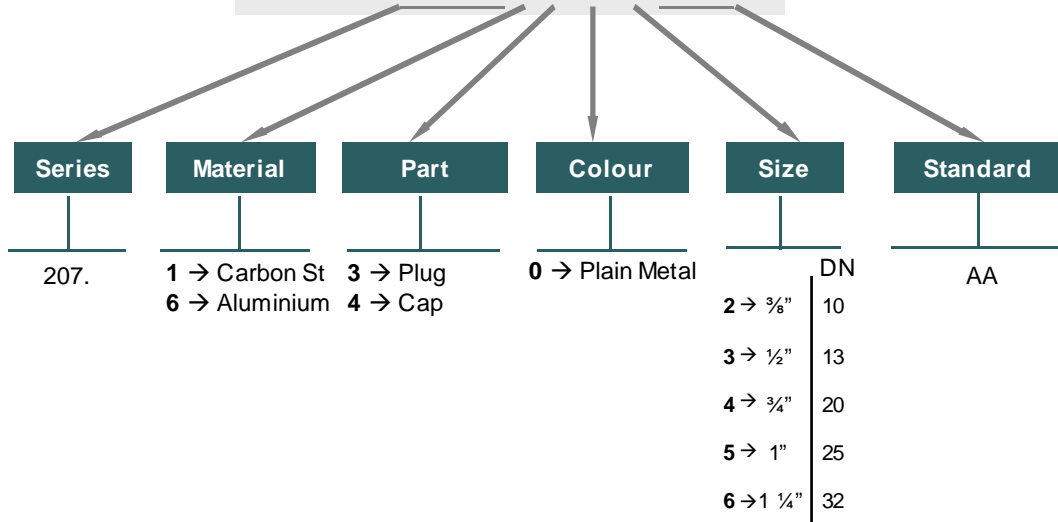

PLUG					
DN	REF.	ØA	ØB	C	L
10	206.6302AA	32x3	39	25	31
13	206.6303AA	36x3	44,5	25	31
20	206.6304AA	48x3	59	32	38
25	206.6305AA	54x4	64	39	45
32	206.6306AA	79x4	89,5	44	50

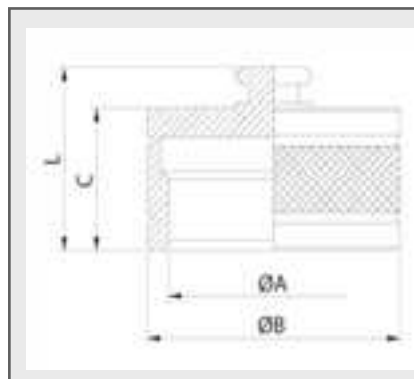

CAP					
DN	REF.	ØA	ØB	C	L
10	206.6402AA	32x3	39	26	32
13	206.6403AA	36x3	44,5	24	30
20	206.6404AA	48x3	59	34	40
25	206.6405AA	54x4	64	42	48
32	206.6406AA	79x4	89,5	74	80



207 SERIES CAT



DIN3852 and other threads available upon request.
AISI 316 available but only for minimum quantities.

• **Materials**

Carbon Steel *EN -10277-3 / AISI 316L*
Seals: NBR, Viton or EPDM
Back-up-ring: PTFE
Springs: *Carbon Steel DIN 17233/84(B)*

• **Applications:** Designed for Oil hydraulic Applications according to European Directive 97.23.EC

• **Equivalence:** DNP VAV

• **Working temperature (Seals)**

	NBR	Viton	EPDM
	+100°C	+200°C	+150°C
	-30°C	-10°C	-40°C

• **Sectors:** Industrial, Agricultural, Construction machinery.

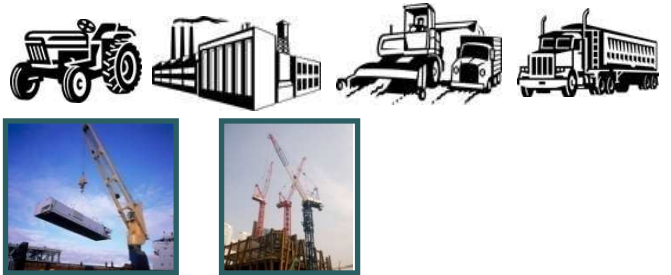

MODEL STRUCTURE

Example;

207.12113 NG

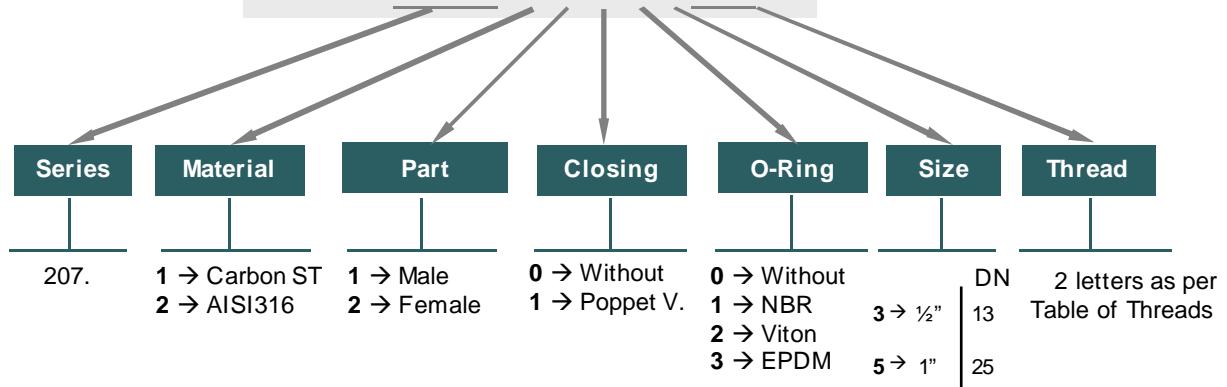



207 SERIES CAT

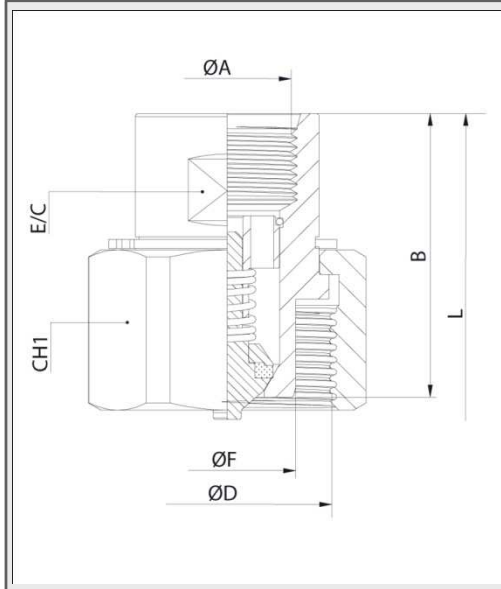

MALE								
DN	ØA	E/C	CH1	B	ØF	ØD	L	REF.
13	M22x1,5	27	41	46	22,25	Rd 35x2	92	207.11113NG 400 Bar
25	M30x1,5	36	65	68	38	Rd 54x3	134	207.11115NS 360 Bar

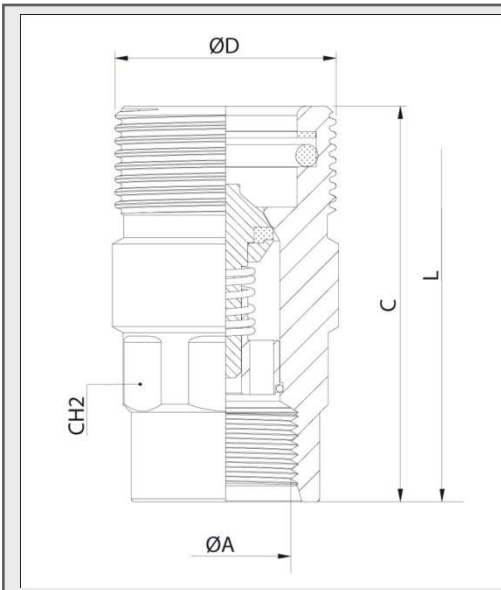

FEMALE							
DN	ØA	CH2	C	ØD	L	REF.	
13	M22x1,5	30	62	Rd 35x2	92	207.12113NG	400Bar
25	M30x1,5	46	96	Rd 54x3	134	207.12115NS	360 Bar



207 SERIES CAT

PLUGS
& CAPS



CAT SERIES PLUGS, CAPS and have been designed to protect FEMALE (coupler) or MALE (nipple) parts while they are disconnected.

MODEL STRUCTURE

Example;

207.6403 AA

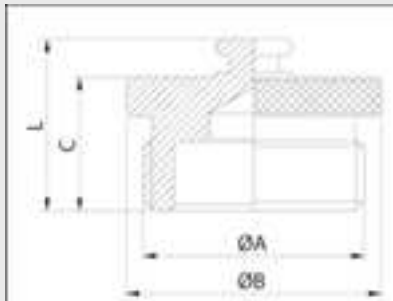
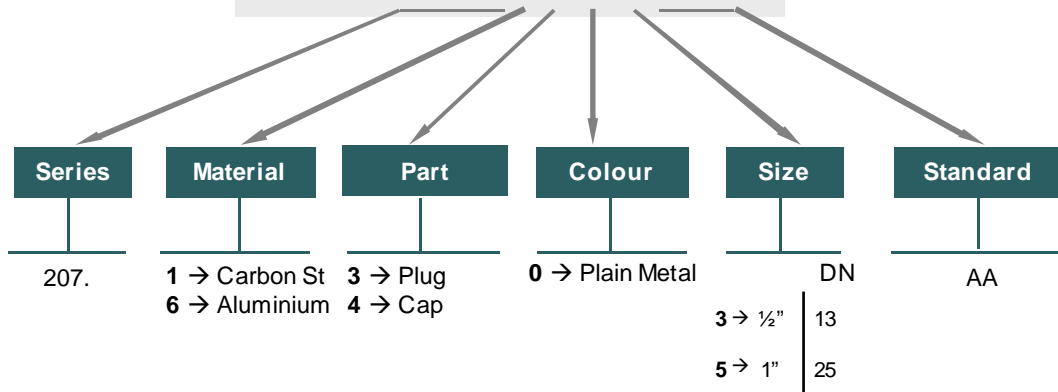

PLUG

DN	REF.	ØA	ØB	C	L
13	207.6303AA	Rd 35x2	40	21	27
25	207.6305AA	Rd 54x3	60	37,5	43,5

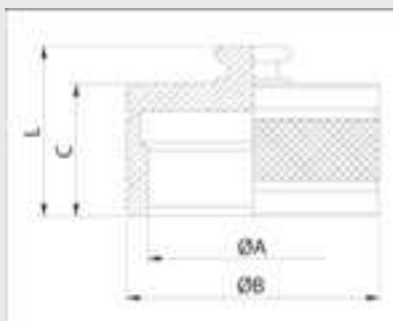

CAP

DN	REF.	ØA	ØB	C	L
13	207.6403AA	Rd 35x2	40	21	27
25	207.6405AA	Rd 54x3	60	29	35

207-3





402 SERIES

V2RH

BSP / NPTF
ORB / SAE



Calibrated steel manufacturing.
Available with or without mounting holes.
Thread combination available upon request of minimum quantities.

• Materials

Carbon Steel *EN -10277-3 / AISI 316L / AISI 303*

Seals: NBR, Viton or EPDM

Seating Ball: P.O.M (Delrin®)

Handle: ZAMAK-5

• **Applications:** Designed for Oil hydraulic Applications according to European Directive 97.23.EC Special for American market

• Equivalence

PISTER BKH
MHA BKH
HYDAC KHB
DMIC DVH

• Working temperature (Seals)

	NBR	Viton	EPDM
+	+100°C	+200°C	+150°C
-	-30°C	-10°C	-40°C

• **Sectors:** Industrial, Agricultural.



MODEL STRUCTURE

Example;

402.1015 AF

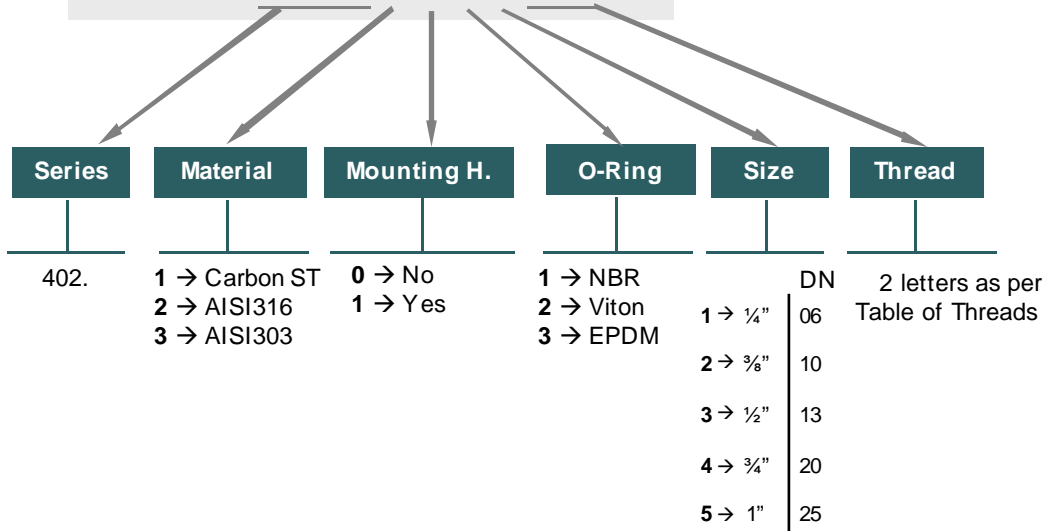

402-1





402 SERIES

V2RH BSP / NPTF
ORB / SAE

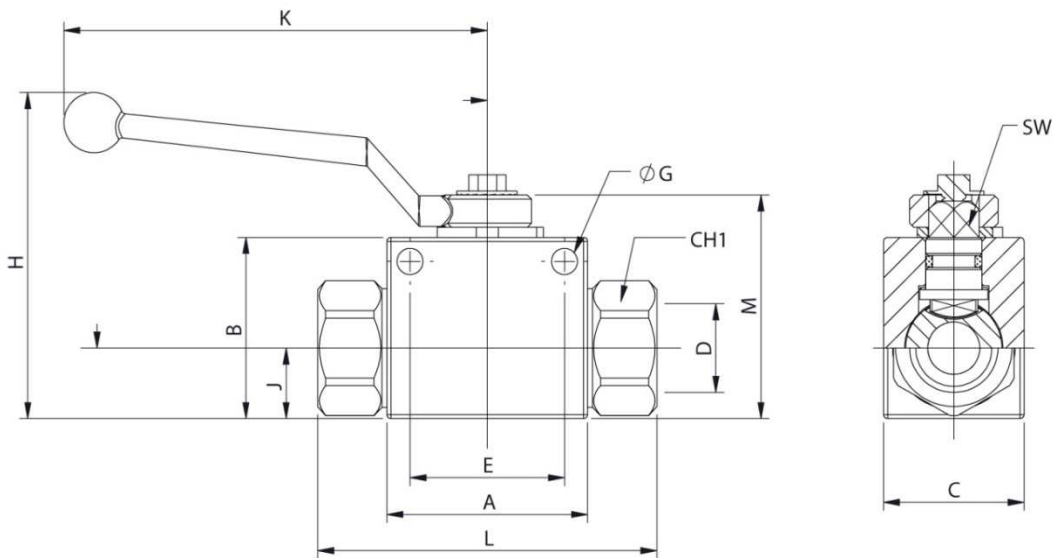

STANDARD MODELS

DN	D	With M.H.	Without M.H.		CH1	L	A	B	M	K	H	J	C	SW	G	E
06	1/4" BSP	402.1111AB	402.1011AB	500Bar	22	72,60	40	35	45,50	105,50	71	13	26	8,90	4,50	31,50
	1/4" NPTF	402.1111BB	402.1011BB													
	7/16"-20ORB	402.1111GA	402.1011GA													
10	3/8" BSP	402.1112AC	402.1012AC	500Bar	27	75,40	45	40	50,50	105,50	76	16	32	8,90	5,20	31,50
	3/8" NPTF	402.1112BC	402.1012BC													
	9/16" ORB	402.1112GC	402.1012GC													
13	1/2" BSP	402.1113AD	402.1013AD	500Bar	30	84,50	50	45	55,50	105,50	81	17,50	35	8,90	6,50	38,50
	1/2" NPTF	402.1113BD	402.1013BD													
	3/4" - 16ORB	402.1113GF	402.1013GF													
20	3/4" BSP	402.1114AE	402.1014AE	400Bar	41	93,40	60	58	73	159,50	108	23	50	13,90	6,50	48,50
	3/4" NPTF	402.1114BE	402.1014BE													
	1 1/16"-12ORB	402.1114GK	402.1014GK													
25	1" BSP	402.1115AF	402.1015AF	350Bar	50	114,50	65	65	80	159,50	115	27,50	57	13,90	8,50	50,50
	1" NPTF	402.1115BF	402.1015BF													
	1 1/4" BSP	402.1115AG	402.1015AG													
	1 1/4" NPTF	402.1115BG	402.1015BG													
	1 1/2" BSP	402.1115AH	402.1015AH													
	1 1/2" NPTF	402.1115BH	402.1015BH													
	1 5/16"-12ORB	402.1115GO	402.1015GO													



402 SERIES

V2RH Mining Industry



Special threads for mining industry
 Calibrated steel manufacturing.
 Available with or without mounting holes.

• Materials

Carbon Steel *EN-10277-3*

Seals: NBR, Viton or EPDM

Seating Ball: P.O.M (Delrin®)

Handle: ZAMAK-5

• Working temperature (Seals)

	NBR	Viton	EPDM
+	+100°C	+200°C	+150°C
-	-30°C	-10°C	-40°C

- **Applications:** Designed for Oil hydraulic Applications according to European Directive 97.23EC Special for American market

• Sectors: Mining industry



MODEL STRUCTURE

Example;

402.1013 MIN3

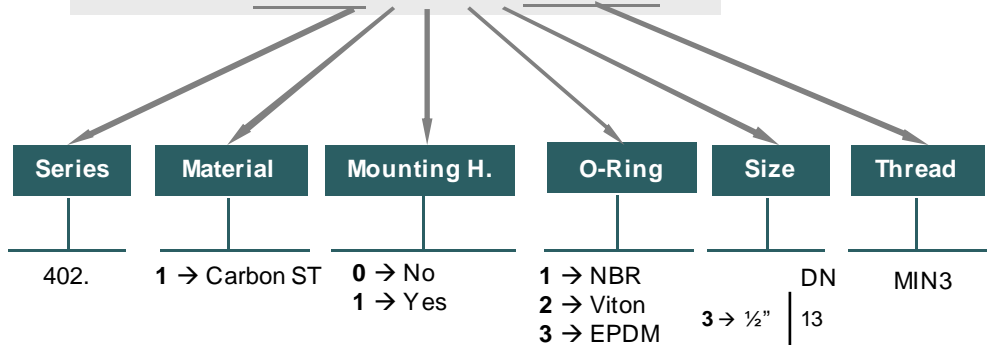

402-3





402 SERIES

V2RH Mining Industry

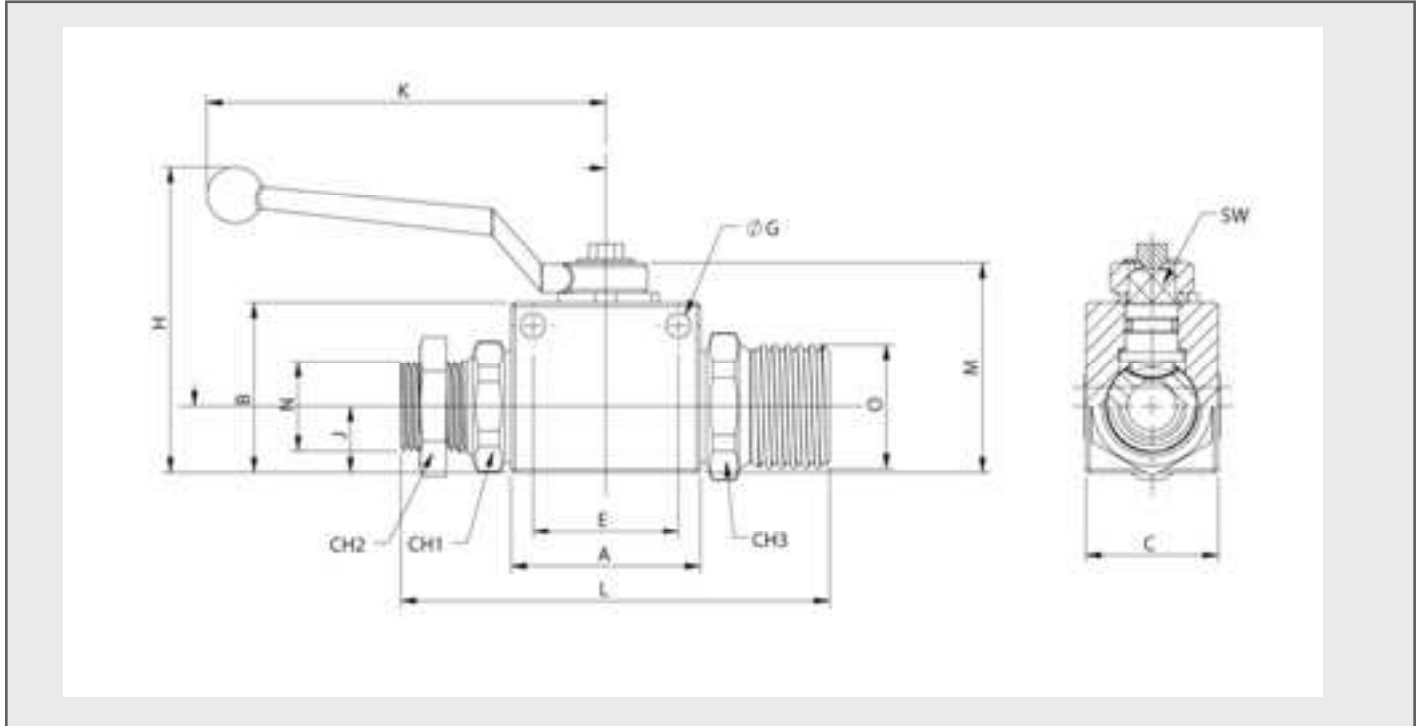

STANDARD MODELS

DN	O	N	With M.H.	Without M.H.		CH1	L	A	B	M	K	H	J	C	SW	G	E
13	Rd 33x3,18	^{3/4"} (Special Mining industry)	402.1013MIN3	402.1113MIN3	500Bar	80	140	100	110	129	214	191	52	100	16,98	*	*

402-4





402 SERIES

V2MT DIN 2353



Calibrated steel manufacturing.
Available with or without mounting holes.
Thread combination available upon request of minimum quantities.

• Materials

Carbon Steel *EN -10277-3 / AISI 316L*

Seals: NBR, Viton or EPDM

Seating Ball: P.O.M (Delrin®)

Handle: ZAMAK-5

• **Applications:** Designed for Oil hydraulic Applications according to European Directive 97.23.EC
Special for American market

• Equivalence

PISTER BKH
MHA BKH
HYDAC KHB

• Working temperature (Seals)

	NBR	Viton	EPDM
	+100°C	+200°C	+150°C
	-30°C	-10°C	-40°C

• **Sectors:** Industrial, Agricultural.



MODEL STRUCTURE

Example;

402.1113 JG

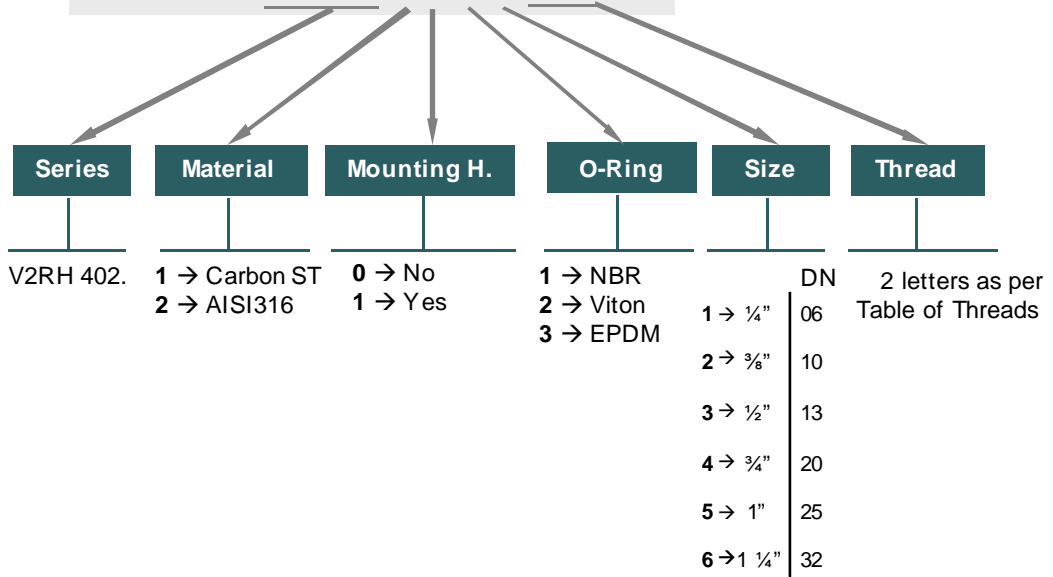

402-5





402 SERIES

V2MT DIN 2353

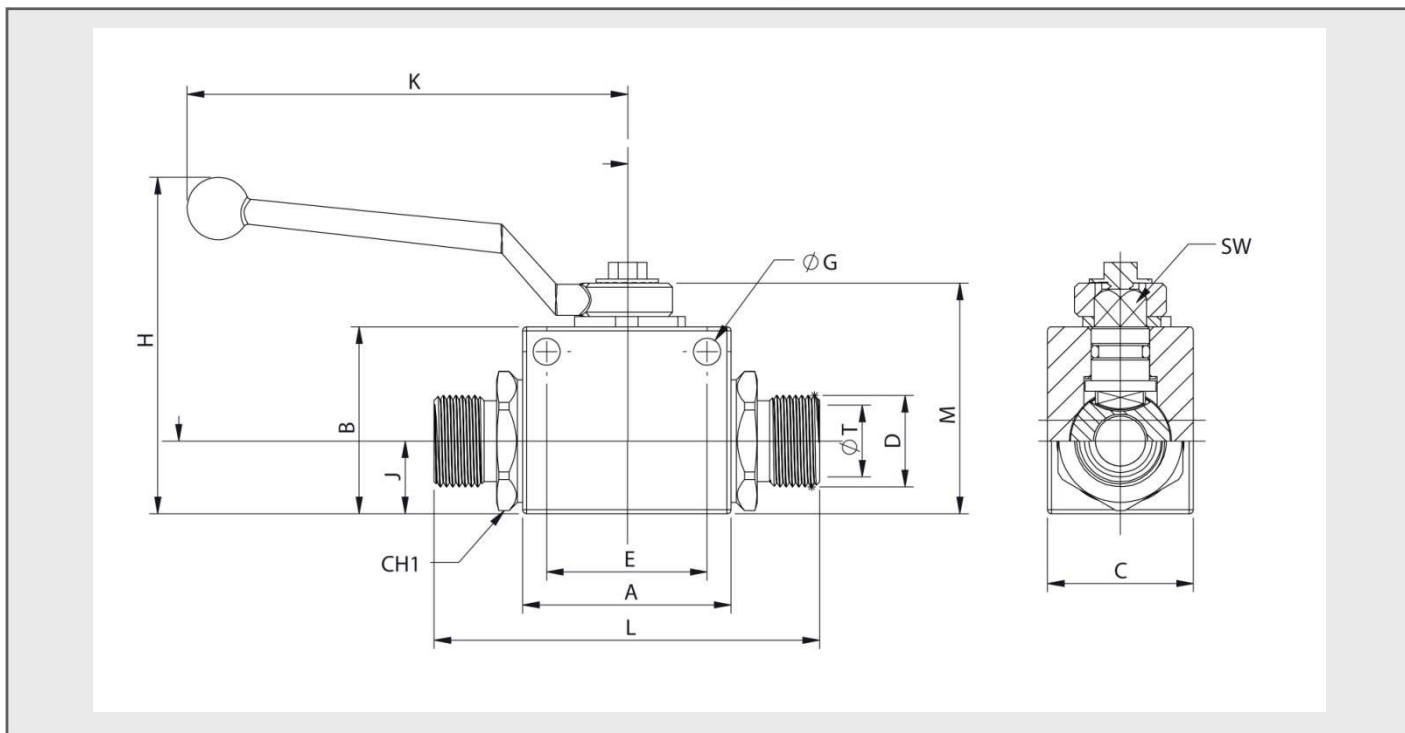

STANDARD MODELS

DN	D	ØT	With M.H.	Without M.H.	CH1	L	A	B	M	K	H	J	C	SW	ØG	E	
06	M12x1,5	6L	402.1111JB	402.1011JB	500Bar	22	78,60										
	M14x1,5	8L	402.1111JC	402.1011JC		79,60	40	35	45,50	105,50	71	13	26	8,90	4,50	31,50	
	M16x1,5	8S	402.1111KD	402.1011KD													
	M18x1,5	10S	402.1111KE	402.1011KE													
10	M16x1,5	10L	402.1112JD	402.1012JD	500Bar	27	79,40	45	35	50,50	105,50	76	16	32	8,90	5,20	31,50
	M18x1,5	12L	402.1112JE	402.1012JE													
	M22x1,5	15L	402.1112JG	402.1012JG													
	M20x1,5	12S	402.1112KF	402.1012KF													
13	M22x1,5	14S	402.1112KG	402.1012KG	500Bar	30	92,50	50	45	55,50	105,50	81	17,50	35	8,90	6,50	38,50
	M22x1,5	15L	402.1113JG	402.1013JG													
	M26x1,5	18L	402.1113JI	402.1013JI													
	M24x1,5	16S	402.1113KH	402.1013KH													
20	M30x2	20S	402.1113KJ	402.1013KJ	400Bar	41	108,40	60	58	73	159,50	108	23	50	13,90	6,50	48,50
	M30x2	22L	402.1114JJ	402.1014JJ													
	M30x2	20S	402.1114KJ	402.1014KJ													
	M36x2	25S	402.1114KK	402.1014KK													
25	M36x2	28L	402.1115JK	402.1015JK	350Bar	46	113,50	65	65	80	159,50	115	27,50	57	13,90	8,50	50,50
	M42x2	30S	402.1115KL	402.1015KL				128,50									

402-6





412 SERIES

V2RD

BSP / NPTF / SAE / ORB
STAINLESS STEEL



Calibrated steel manufacturing.
Thread combination available upon request of minimum quantities.

• Materials

Carbon Steel *EN -10277-3*, Stainless Steel *AISI 316L*,

Stainless Steel *AISI 303*

Seals: NBR, Viton or EPDM

Seating Ball: P.O.M (Delrin®)

Handle: ZAMAK-5

• **Applications:** Designed for Oil hydraulic Applications according to European Directive 97.23.EC

• Equivalence

PISTER BKH

MHA BKH

HYDAC BKH

DMIC BVH

• Working temperature (Seals)

	NBR	Viton	EPDM
	+100°C	+200°C	+150°C
	-30°C	-10°C	-40°C

• **Sectors:** Industrial, Agricultural.



MODEL STRUCTURE

Example;

412.2014 GK

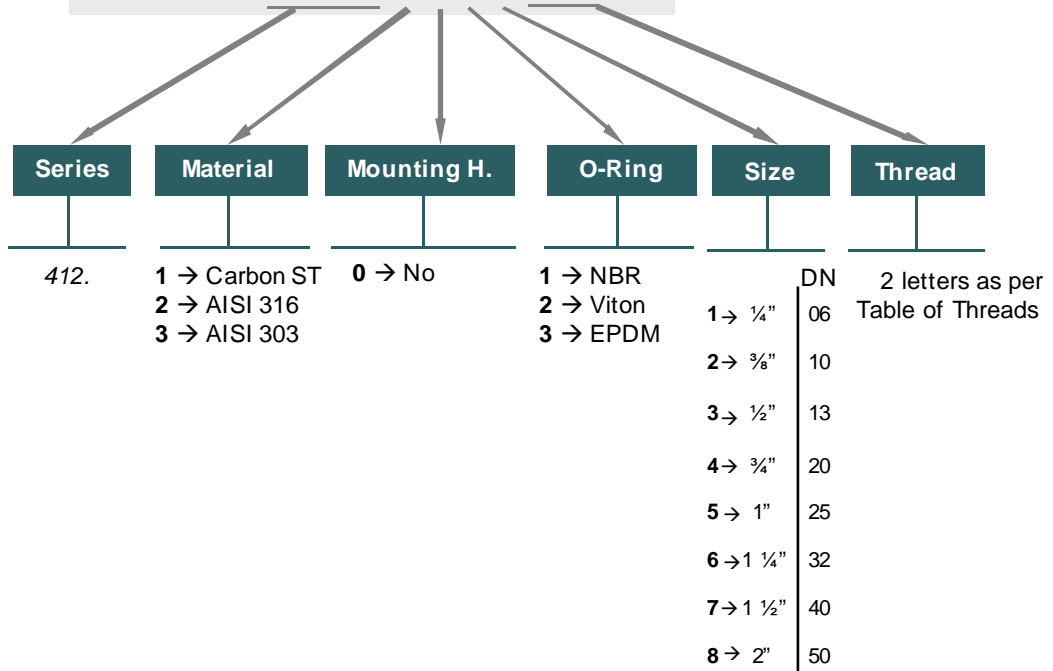

412-1





412 SERIES

V2RD

BSP / NPTF / SAE / ORB
STAINLESS STEEL

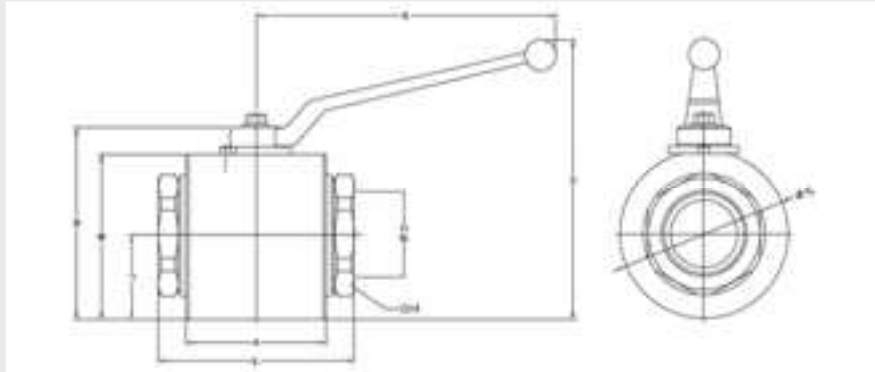

DN	CH1	L	A	M	K	H	J	B	ØC
06	22	74,50	40	45,50	105,50	71	13	35	38
10	27		45	50,50		76	16	40	45
13	30	84,50	50	55,50	159,50	81	17,50	45	48
20	41	93,40	60	73		108	50	59,5	65
25	46	114,50	65	80	214	115	27,50	65	70
	50	136,50							
	55	146,50							
32	55	110	80	100	214	135	41	85,75	90
40	65	120	85	114		176	44,50	105	110
50	80	140	100	129	214	191	52	115	120

STANDARD MODELS (AISI 316)

DN	Ø D	REF.	
06	1/4" BSP	412.2021AB	500Bar
	1/4" NPTF	412.2021.BB	
	7/16"-20ORB	412.2021GA	
10	3/8" BSP	412.2022AC	500Bar
	3/8" NPTF	412.2022BC	
	9/16"-18ORB	412.2022GC	
13	1/2" BSP	412.2023AD	500Bar
	1/2" NPTF	412.2023BD	
	3/4" - 16ORB	412.2023GF	
20	3/4" BSP	412.2024.AE	400Bar
	3/4" NPTF	412.2024BE	
	1 1/16"-12ORB	412.2024GK	
25	1" BSP	412.2025AF	350Bar
	1" NPTF	412.2025BF	
	1 1/4" BSP	412.2025AG	
	1 1/4" NPTF	412.2025BG	
	1 1/2" BSP	412.2025AH	
32	1 1/2" NPTF	412.2025BH	320Bar
	1 5/16"-12ORB	412.2025GO	
	1 1/4" BSP	412.2026AG	
40	1 1/4" NPTF	412.2026BG	320Bar
	1 5/8"-12ORB	412.2026GT	
	1 1/2" BSP	412.2027AH	
50	1 1/2" NPTF	412.2027BH	320Bar
	2" BSP	412.2028AI	
	2" NPTF	412.2028BI	

Safety pressure factor 1:4

STANDARD MODELS (AISI 316)

DN	D	ØT	REF.	
06	M12x1,5	6L	412.2021JB	500Bar
	M14x1,5	8L	412.2021JC	
	M16x1,5	8S	412.2021KD	
	M18x1,5	10S	412.2021KE	
10	M16x1,5	10L	412.2022JD	500Bar
	M18x1,5	12L	412.2022JE	
	M22x1,5	15L	412.2022JG	
	M20x1,5	12S	412.2022KF	
	M22x1,5	14S	412.2022KG	
13	M22x1,5	15L	412.2023JG	500Bar
	M26x1,5	18L	412.2023JI	
	M24x1,5	16S	412.2023KH	
	M30x2	20S	412.2023KJ	
20	M30x2	22L	412.2024JJ	400Bar
	M30x2	20S	412.2024KJ	
	M36x2	25S	412.2024KK	
25	M36x2	28L	412.2025JK	350Bar
	M42x2	30S	412.2025KL	
32	M45x2	35L	412.2026JM	320Bar
	M52x2	38S	412.2026KN	

412-2





412 SERIES

V2RD BSP / NPTF / SAE / ORB
CARBON STEEL

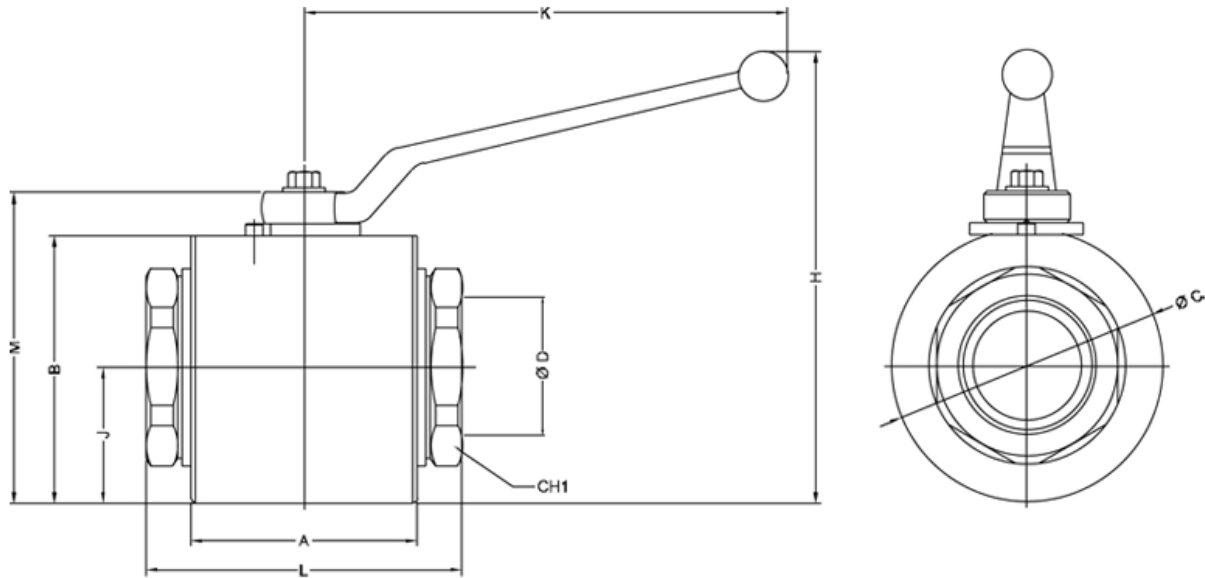

DN	CH1	L	A	M	K	H	J	B	ØC
32	55	110	80	100	159,50	135	41	85,75	90
40	65	120	85	114	214	176	44,50	105	110
50	80	140	100	129		191	52	115	120

STANDARD MODELS (CARBON STEEL)

DN	D	ØT	REF.	
32	M45x2	35L	412.1016JM	320Bar
	M52x2	38S	412.1016KN	

STANDARD MODELS (CARBON STEEL)

DN	Ø D	REF.	
32	1 ¼" BSP	412.1016AG	320Bar
	1 ¼" NPTF	412.1016BG	
	1 5/8"-12ORB	412.1016GT	
40	1 ½" BSP	412.1017AH	320Bar
	1 ½" NPTF	412.1017BH	
50	2" BSP	412.1018AI	320Bar
	2" NPTF	412.1018BI	





432 SERIES

V3RH

BSP / NPTF
ORB / SAE



Calibrated steel manufacturing.
Available with or without mounting holes.
Thread combination available upon request of minimum quantities.

• Materials

Carbon Steel *EN -10277-3*
Seals: NBR, Viton or EPDM
Seating Ball: P.O.M (Delrin®)
Handle: ZAMAK-5

• **Applications:** Designed for Oil hydraulic Applications according to European Directive 97.23.EC Special for American market

• Equivalence

PISTER BK3
MHA BK3
HYDAC KHB3K

• Working temperature (Seals)

	NBR	Viton	EPDM
+	+100°C	+200°C	+150°C
-	-30°C	-10°C	-40°C

• **Sectors:** Industrial, Agricultural.



MODEL STRUCTURE

Example;

432.1113 AD

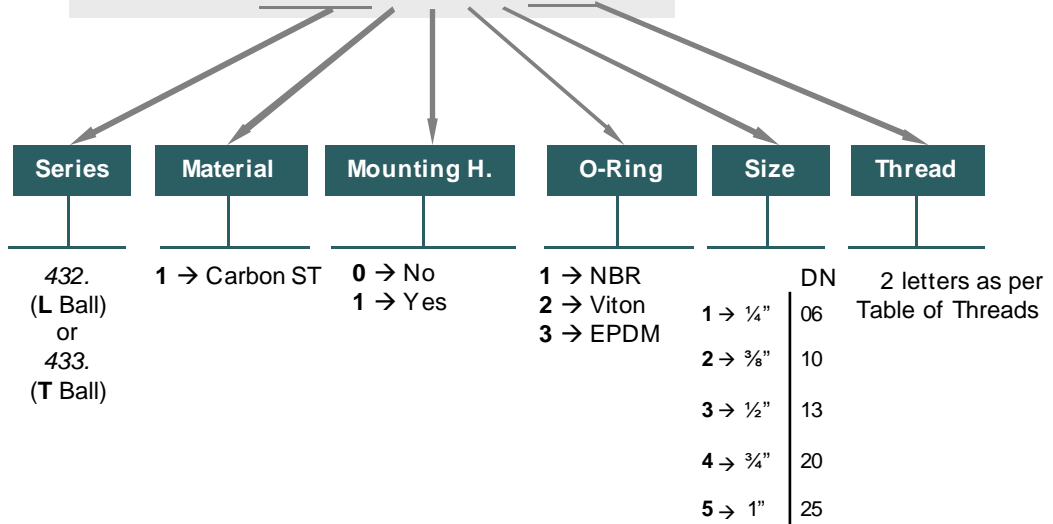

432-1





432 SERIES

V3RH BSP / NPTF
ORB / SAE

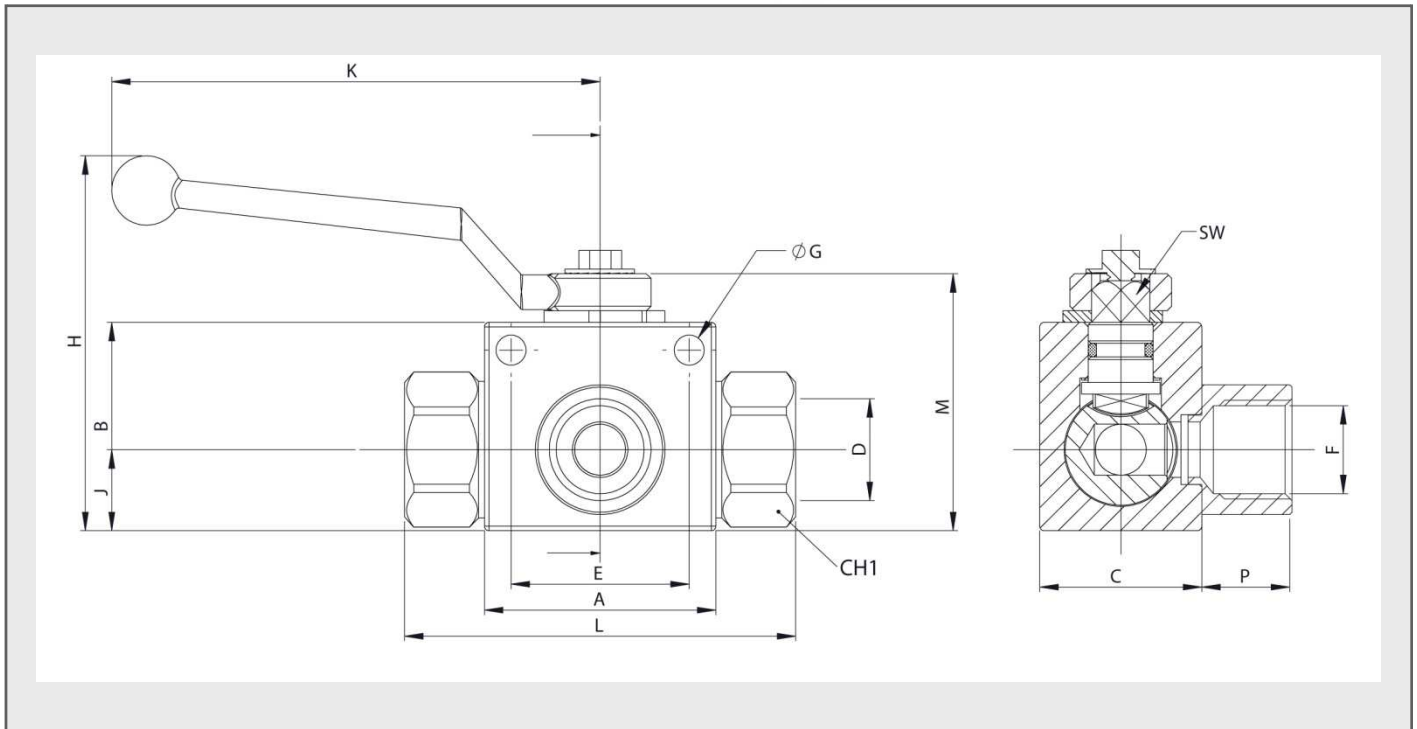

(A dimension)

STANDARD MODELS

DN	D / F	With M.H.	Without M.H.		CH1	L	A	B	M	K	H	J	C	SW	Ø G	E	P
06	1/4" BSP	432.1111AB	432.1011AB	500Bar	22	72,60	40	35	45,50	105,50	71	13	26	8,90	4,50	31,50	13
	1/4" NPTF	432.1111BB	432.1011BB														14
	7/16"-20ORB	432.1111GA	432.1011GA														14
10	3/8" BSP	432.1112AC	432.1012AC	500Bar	27	75,40	45	40	50,50	105,50	76	16	32	8,90	5,20	31,50	15
	3/8" NPTF	432.1112BC	432.1012BC														16
	9/16" ORB	432.1112GC	432.1012GC														16
13	1/2" BSP	432.1113AD	432.1013AD	500Bar	30	84,50	50	45	55,50	105,50	81	17,50	35	8,90	6,50	38,50	19,50
	1/2" NPTF	432.1113BD	432.1013BD														19,50
	3/4" - 16ORB	432.1113GF	432.1013GF														19,50
20	3/4" BSP	432.1114AE	432.1014AE	400Bar	41	93,40	60	60	73	159,50	108	23	50	13,90	6,50	48,50	21
	3/4" NPTF	432.1114BE	432.1014BE														21
	1 1/16"-12ORB	432.1114GK	432.1014GK														21
25	1" BSP	432.1115AF	432.1015AF	350Bar	46	114,50	65	65	80	159,50	115	27,50	57	13,90	8,50	50,50	25
	1" NPTF	432.1115BF	432.1015BF		25												
	1 1/4" BSP	432.1115AG	432.1015AG		31												
	1 1/4" NPTF	432.1115BG	432.1015BG		25												
	1 1/2" BSP	432.1115AH	432.1015AH		32												
	1 1/2" NPTF	432.1115BH	432.1015BH		25												
	1 5/16" -12ORB	432.1115GO	432.1015GO		25												

TYPE "L" BALL

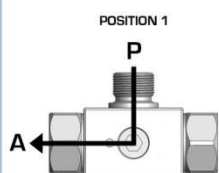

B

POSITION 2

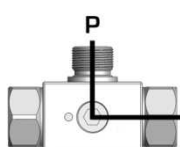

A

TYPE "T" BALL

POSITION 1

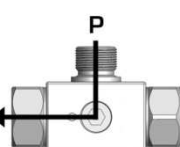

B

POSITION 2

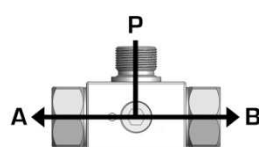

A

432-2





432 SERIES

V3MT DIN 2353



Calibrated steel manufacturing.
Available with or without mounting holes.
Thread combination available upon request of minimum quantities.

• Materials

Carbon Steel *EN-10277-3*
Seals: NBR, Viton or EPDM
Seating Ball: P.O.M (Delrin®)
Handle: ZAMAK-5

• **Applications:** Designed for Oil hydraulic Applications according to European Directive 97.23.EC Special for American market

• Equivalence

PISTER BK3
MHA BK3
HYDAC KHB3k

• Working temperature (Seals)

	NBR	Viton	EPDM
	+100°C	+200°C	+150°C
	-30°C	-10°C	-40°C

• **Sectors:** Industrial, Agricultural.



MODEL STRUCTURE

Example;

432.1013 KD

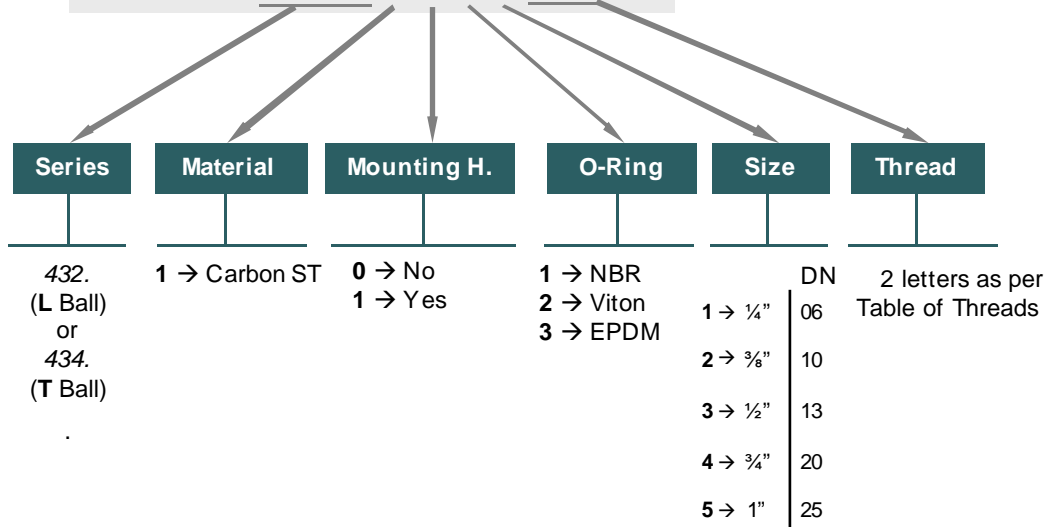

432-3





432 SERIES

V3MT DIN 2353

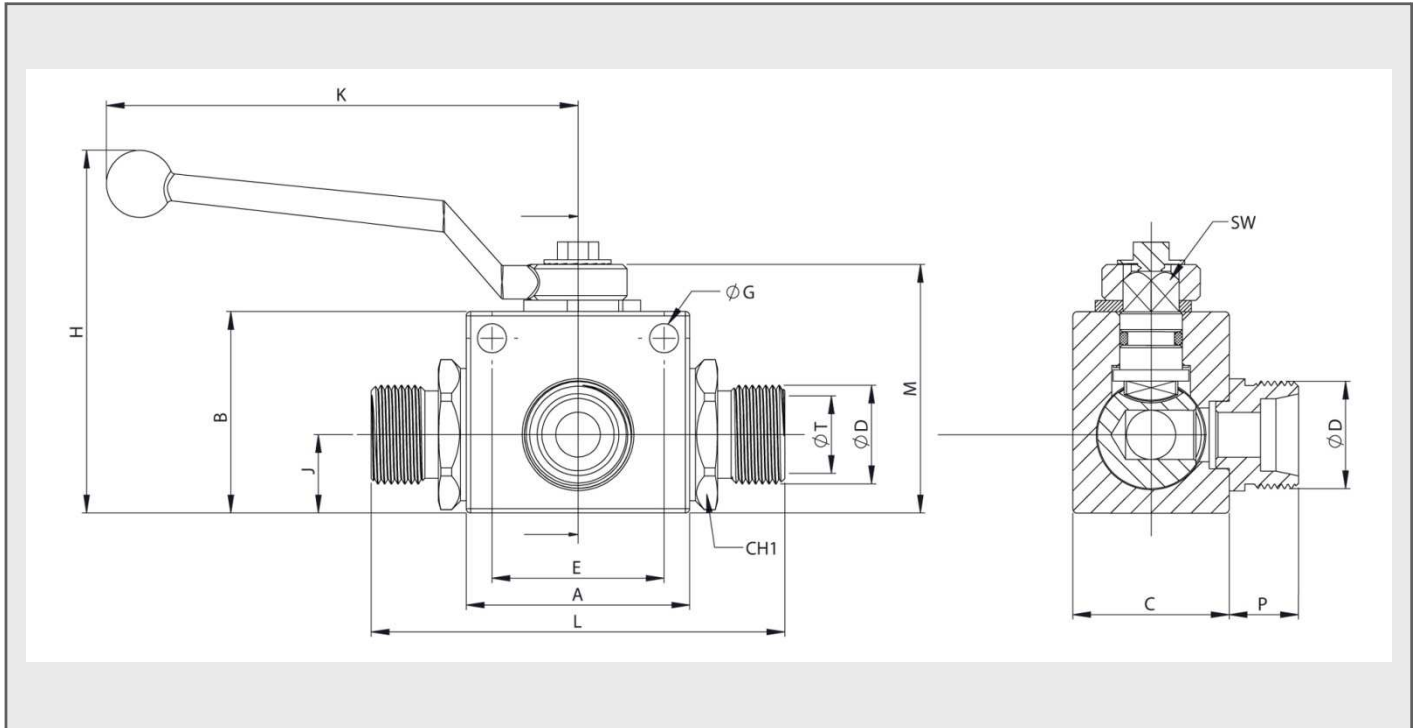

(A dimension)

STANDARD MODELS

DN	D	ØT	With M.H.	Without M.H.		CH1	L	A	B	M	K	H	J	C	SW	ØG	E	P
06	M12x1,5	6L	432.1111JB	432.1011JB	500Bar	22	78,60	40	35	45,50	105,50	71	13	26	8,90	4,50	31,50	13
	M14x1,5	8L	432.1111JC	432.1011JC			79,60											
	M16x1,5	10L	432.1111JD	432.1011JD			78,60											
	M16x1,5	8S	432.1111KD	432.1011KD			79,60											
	M18x1,5	10S	432.1111KE	432.1011KE			79,60											
10	M16x1,5	10L	432.1112JD	432.1012JD	500Bar	27	77,40	45	40	50,50	105,50	76	16	32	8,90	5,20	31,50	15
	M18x1,5	12L	432.1112JE	432.1012JE			77,40											
	M22x1,5	15L	432.1112JG	432.1012JG			79,40											
	M20x1,5	12S	432.1112KF	432.1012KF			79,40											
	M22x1,5	14S	432.1112KG	432.1012KG			79,40											
13	M22x1,5	15L	432.1113JG	432.1013JG	500Bar	30	92,50	50	45	55,50	105,50	81	17,50	35	8,90	6,50	38,50	15,50
	M26x1,5	18L	432.1113JI	432.1013JI			92,50											
	M24x1,5	16S	432.1113KH	432.1013KH			92,50											
	M30x2	20S	432.1113KJ	432.1013KJ			98,50											
	M30x2	22L	432.1114JJ	432.1014JJ			108,40											
20	M30x2	20S	432.1114KJ	432.1014KJ	400Bar	41	114,40	60	58	73	159,50	108	23	50	13,90	6,50	48,50	17
	M36x2	25S	432.1114KK	432.1014KK			114,40											
	M36x2	28L	432.1115JK	432.1015JK			114,40											
25	M36x2	28L	432.1115JK	432.1015JK	350Bar	46	128,50	65	65	80	159,50	115	27,50	57	13,90	8,50	50,50	25
	M42x2	30S	432.1115KL	432.1015KL			128,50											

TYPE "L" BALL

TYPE "T" BALL

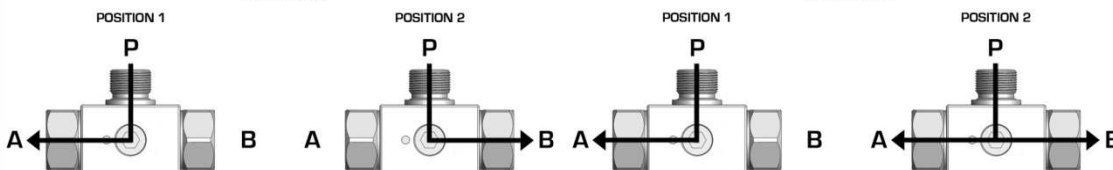

432-4





433 SERIES

V3RH

BSP
F-M-F



Calibrated steel manufacturing.
Available with or without mounting holes.
Thread combination available upon request of minimum quantities.

• Materials

Carbon Steel *EN -10277-3*
Seals: NBR, Viton or EPDM
Seating Ball: P.O.M (Delrin®)
Handle: ZAMAK-5

• Working temperature (Seals)

	NBR	Viton	EPDM
+	+100°C	+200°C	+150°C
-	-30°C	-10°C	-40°C

• **Applications:** Designed for Oil hydraulic Applications according to European Directive 97.23.EC Special for American market

• **Sectors:** Industrial, Agricultural.



MODEL STRUCTURE

Example;

433.1115 AG

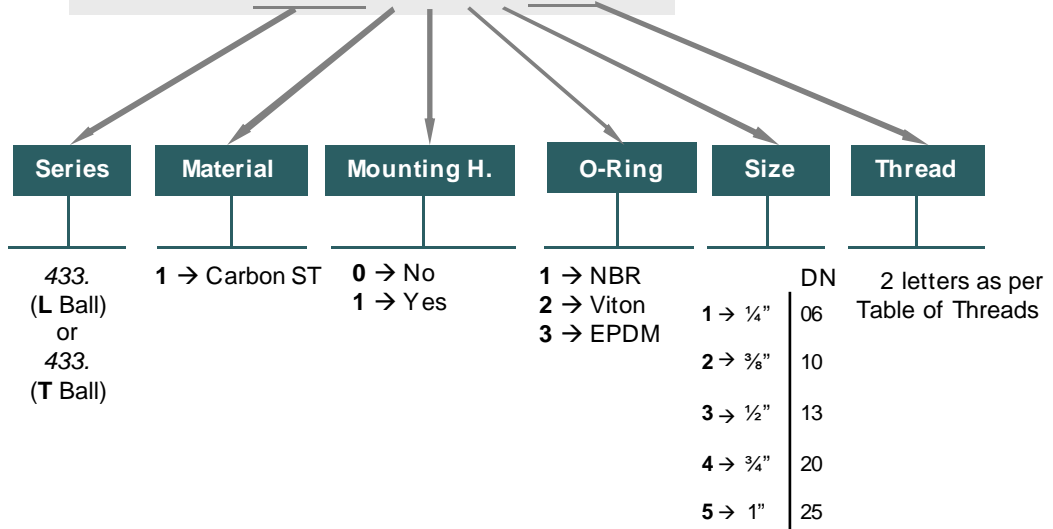

433-1





433 SERIES

V3RH BSP
F-M-F

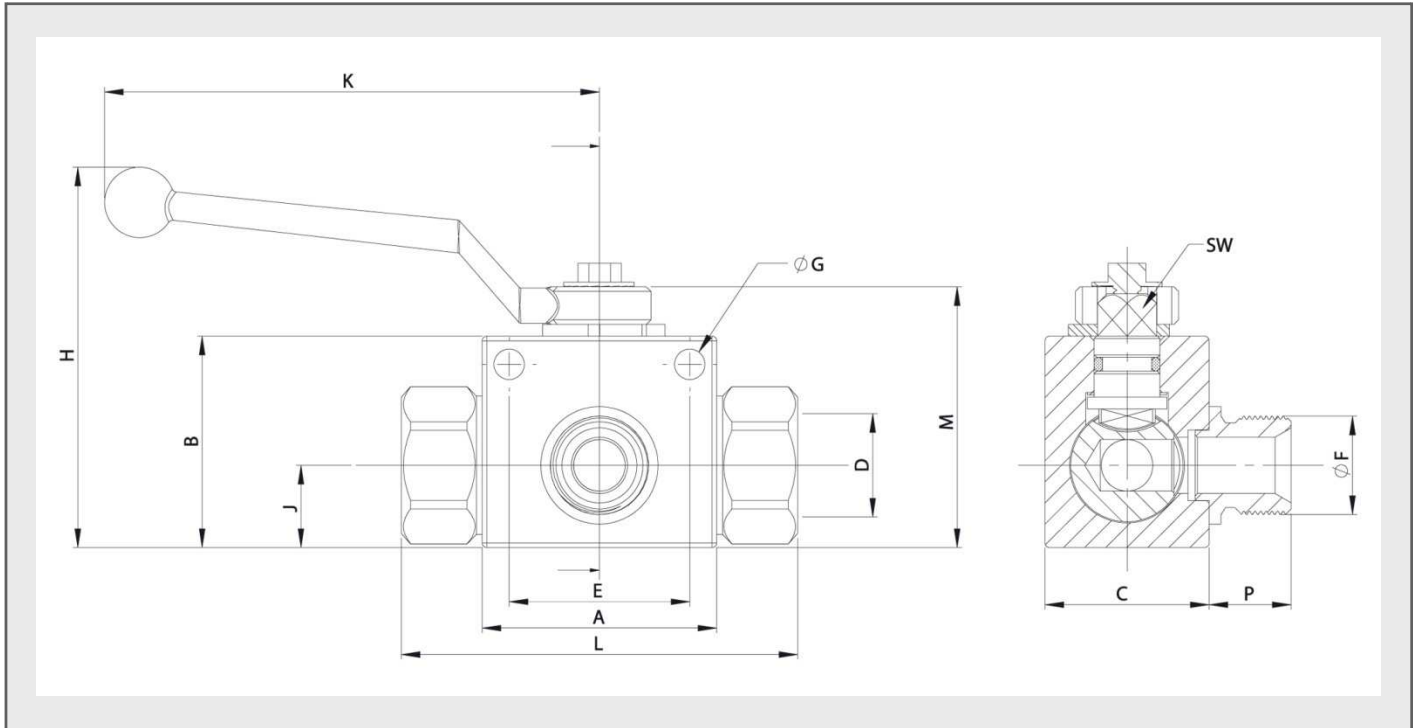

(A dimension)

STANDARD MODELS

DN	D / F	With M.H.	Without M.H.	CH1	L	A	B	M	K	H	J	C	SW	G	E	P	
06	¼" BSP	433.1111AB	433.1011AB	500Bar	22	72,60	40	35	45,50	105,50	71	13	26	8,90	4,50	31,50	13
10	⅜" BSP	433.1112AC	433.1012AC		27	75,40	45	40	50,50	105,50	76	16	32	8,90	5,20	31,50	15
13	½" BSP	433.1113AB	433.1013AB		30	84,50	50	45	55,50	105,50	81	17,50	35	8,90	6,50	38,50	17,50
20	¾" BSP	433.1114AE	433.1014AE	400Bar	41	93,40	60	60	73	159,50	108	23	50	13,90	6,50	48,50	19
	1" BSP	433.1115AF	433.1015AF		46	114,50											25
25	1 ¼" BSP	433.1115AG	433.1015AG	350Bar	50	136,50	65	65	80	159,50	115	27,50	57	13,90	8,50	50,50	28
	1 ½" BSP	433.1115AH	433.1015AH		55	146,50											

TYPE "L" BALL

TYPE "T" BALL

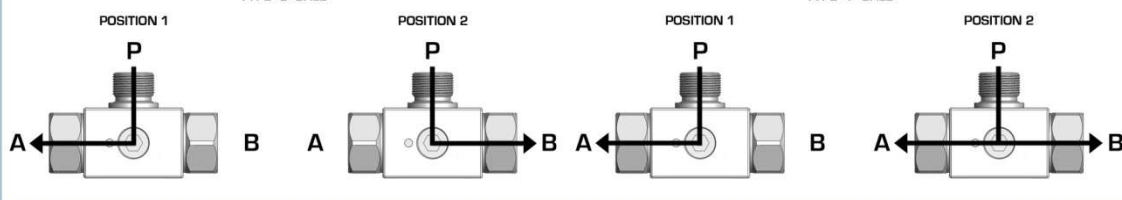

433-2





452 SERIES

V2CR BSP / NPTF SAE /
ORB DIN2353



Calibrated steel manufacturing.
With bulkhead thread and nut to assembly in panels
Thread combination available upon request of minimum quantities.

• Materials

Carbon Steel *EN -10277-3*
Seals: NBR, Viton or EPDM
Seating Ball: P.O.M (Delrin®)
Handle: ZAMAK-5

• **Applications:** Designed for Oil hydraulic Applications according to European Directive 97.23.EC
Special for American market

• Equivalence

INTEVA STANDARD

• Working temperature (Seals)

	NBR	Viton	EPDM
+	+100°C	+200°C	+150°C
-	-30°C	-10°C	-40°C

• **Sectors:** Industrial, Agricultural.



MODEL STRUCTURE

Example;

452.1112 KF

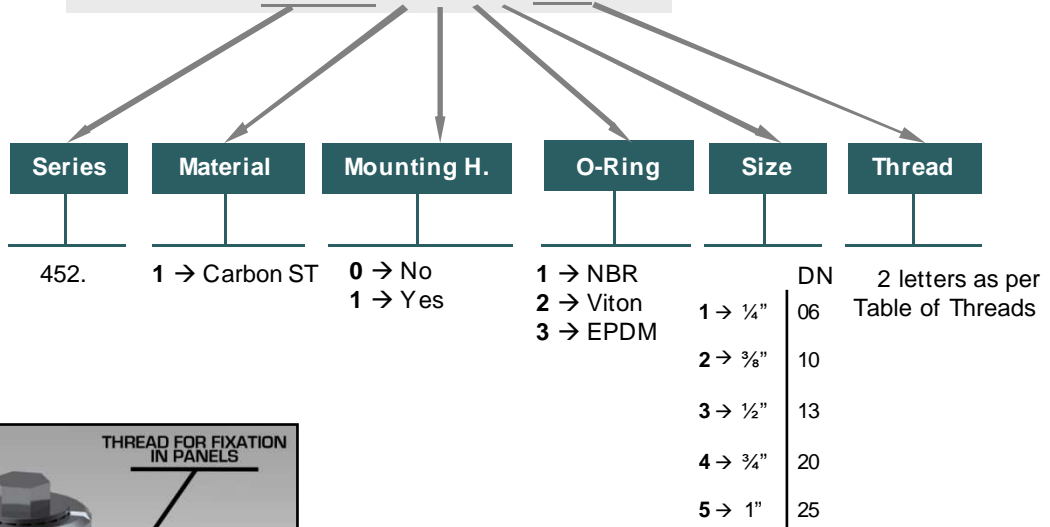

452-1





452 SERIES

V2CR BSP / NPTF SAE /
ORB DIN2353

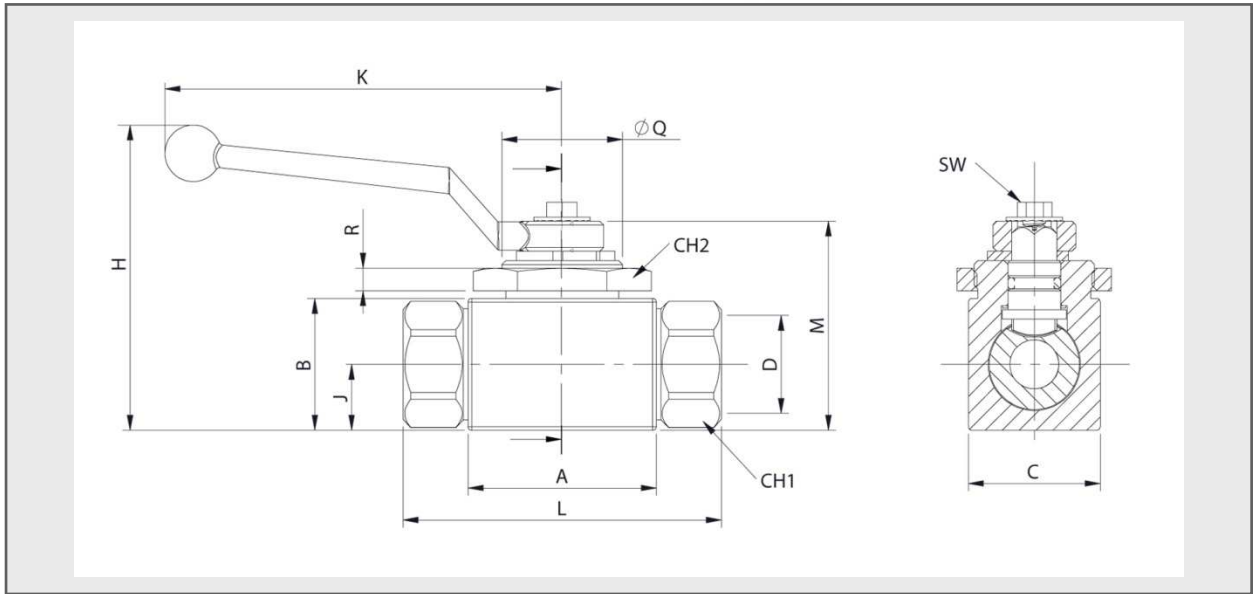

STANDARD MODELS

DN	D	REF.		CH1	CH2	L	A	B	M	K	H	J	C	SW	R	Ø Q
	1/4" BSP	452.1011AB														
	1/4" NPTF	452.1011BB				72,60										
	7/16" -12ORB	452.1011GA														
06	M12x1,5 6L	452.1011JB		22	30	78,60	40	35	45,50	105,50	71	13	26	8,90	6	M32x1,5
	M14x1,5 8L	452.1011JC														
	M16x1,5 10L	452.1011JD				79,60										
	M16x1,5 8S	452.1011KD														
	3/8" BSP	452.1012AC														
	3/8" NPTF	452.1012BC				75,40										
	9/16" -18ORB	452.1012GC														
10	M16x1,5 10L	452.1012JD	500Bar	27	41	77,40	45	40	50,50	105,50	76	16	32	8,90	6	M32x1,5
	M18x1,5 12L	452.1012JE														
	M22x1,5 15L	452.1012JG				79,40										
	M20x1,5 12S	452.1012KF														
	M22x1,5 14S	452.1012KG														
	1/2" BSP	452.1013AD														
	1/2" NPTF	452.1013BD				84,50										
	3/4" -16ORB	452.1013GF														
13	M22x1,5 15L	452.1013JG		30	41		50	45	55,50	105,50	81	17,50	35	8,90	6	M32x1,5
	M26x1,5 18L	452.1013JI														
	M24x1,5 16S	452.1013KH				92,50										
	M30x2 20S	452.1013KJ														
	3/4" BSP	452.1014AE														
	3/4" NPTF	452.1014BE				93,40										
20	1 1/16" -12ORB	452.1014GK	400Bar	41	50		60	58	73	159,50	108	23	50	13,90	6	M45x1,5
	M30x2 22L	452.1014JJ				108,40										
	M30x2 20S	452.1014KJ														
	M36x2 25S	452.1014KK				114,40										
	1" BSP	452.1015AF														
25	1" NPTF	452.1015BF	350Bar	46	50	114,50	65	65	80	159,50	115	27,50	57	13,90	6	M45x1,5
	1 2/16" -12ORB	452.1015GO														
	M36x2 28L	452.1015JK				113,50										





453 SERIES

V3CR

BSP
F-M-F



Calibrated steel manufacturing.
Available with and without mounting holes.
Thread combination available upon request of minimum quantities.

• Materials

Carbon Steel *EN -10277-3*
Seals: NBR, Viton or EPDM
Seating Ball: P.O.M (Delrin®)
Handle: ZAMAK-5

• Working temperature (Seals)

	NBR	Viton	EPDM
	+100°C	+200°C	+150°C
	-30°C	-10°C	-40°C

• **Applications:** Designed for Oil hydraulic Applications according to European Directive 97.23.EC Special for American market

• **Sectors:** Industrial, Agricultural.



MODEL STRUCTURE

Example;

453.1014 AE

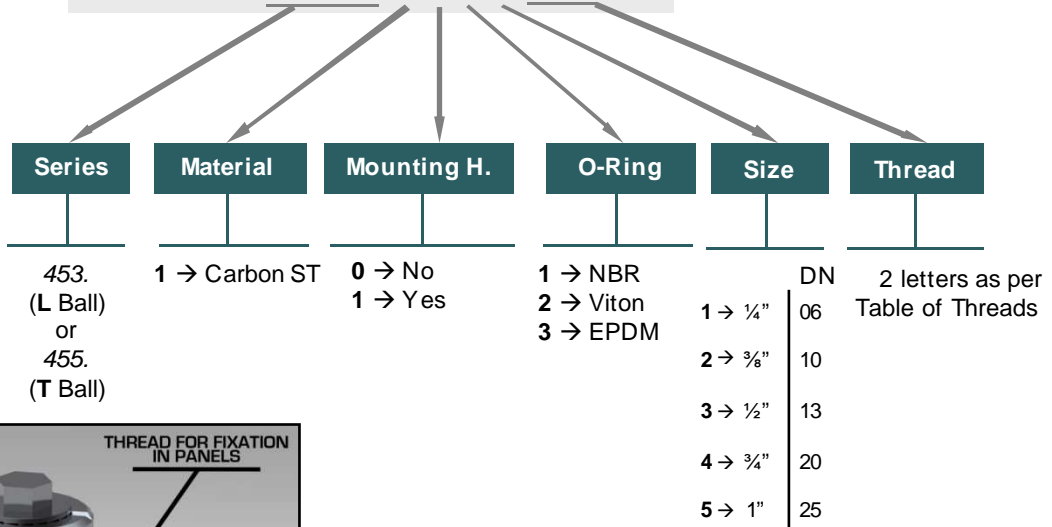

453-1





453 SERIES

V3CR BSP
F-M-F

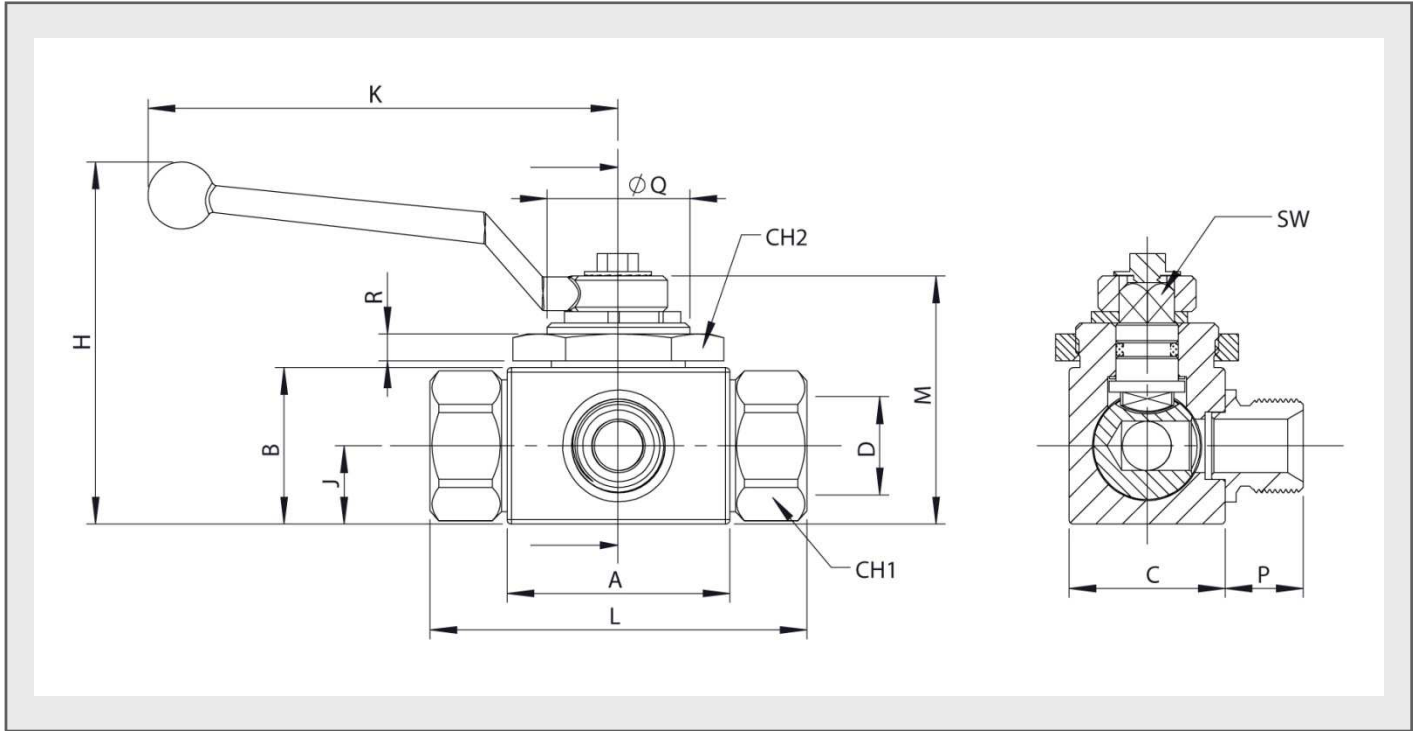

STANDARD MODELS

DN	D	REF.		CH1	CH2	L	A	B	M	K	H	J	C	SW	R	Q	P
06	1/4" BSP	453.1011AB	500Bar	22	30	72,60	40	35	45,50	105,50	71	13	26	8,90	6	M32x1,5	13
10	3/8" BSP	453.1012AC		27	41	75,40	45	40	50,50		76	16	32				
13	1/2" BSP	453.1013AD	400Bar	30	50	84,50	50	45	55,50	159,50	81	17,50	35	13,90		M32x1,5	17,5
20	3/4" BSP	453.1014AE		41	50	93,40	60	58	73		108	23	50				
25	1" BSP	453.1015AF	350Bar	46	50	114,50	65	65	80		115	27,50	57			M45x1,5	25

TYPE "L" BALL

TYPE "T" BALL

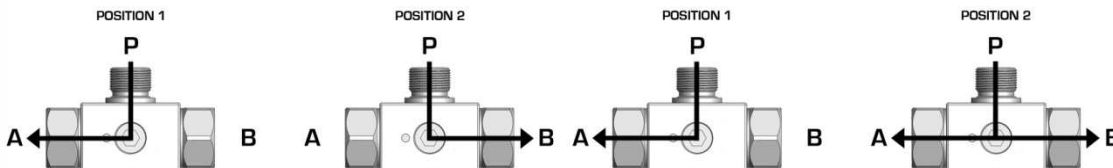

453-2





470 SERIES EK2

BSP
DIN2353

Calibrated steel manufacturing.
Thread combination available upon request of minimum quantities.

• Materials

Carbon Steel *EN -10277-3*

Seals: NBR, Viton or EPDM

Handle: ZAMAK-5

• Working temperature (Seals)

	NBR	Viton	EPDM
+	+100°C	+200°C	+150°C
-	-30°C	-10°C	-40°C

- **Applications:** Designed for Oil hydraulic Applications according to European Directive 97.23.EC Special for American market

- **Sectors:** Industrial, Agricultural.



MODEL STRUCTURE

Example;

470.1014 AE

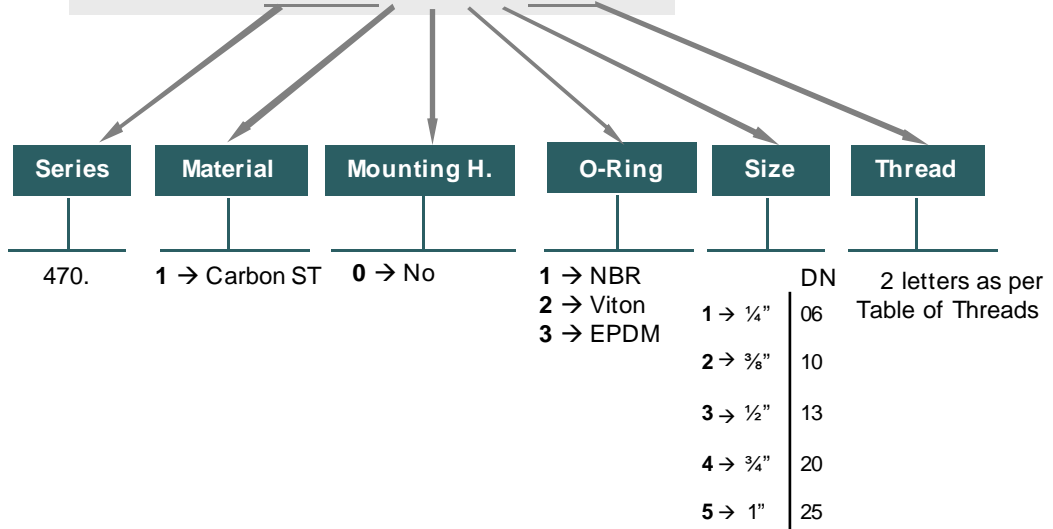

470-1





470 SERIES EK2

BSP
DIN2353

STANDARD MODEL

DN	Ø F	REF.		Ø A	B	C	D	E
10	3/8" BSP	470.1012AC	250Bar	36	56	26,85	112	53

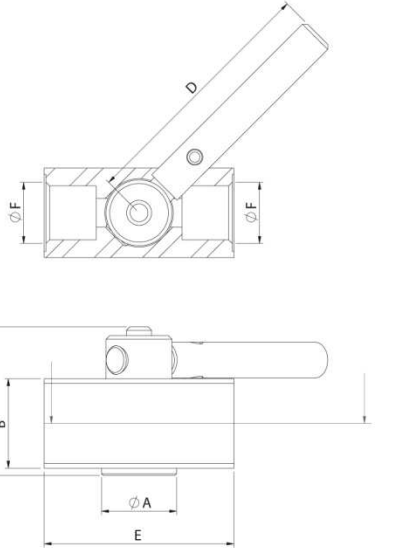

STANDARD MODEL

DN	Ø F	REF.		Ø A	B	C	D	E
10	M20x1,5	470.1012KFA	250Bar	36	56	26,85	112	53

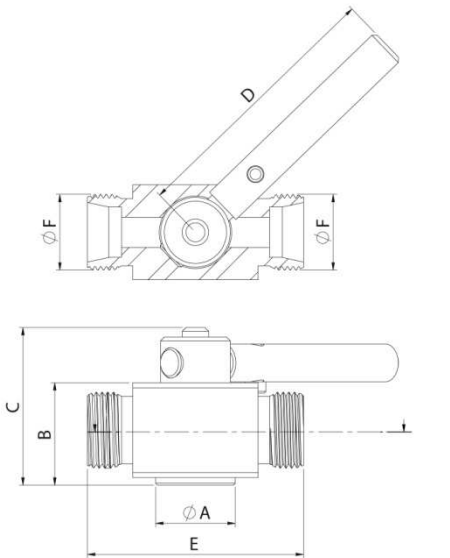

470-2



471 SERIES

EK3

BSP



Steel manufacturing.
Designed without inner ball. Spin movement allows opening and closing the valve.
BSP Threads, others available upon request.

• Materials

Carbon Steel *EN-10277-3*

Seals: NBR, Viton or EPDM

Handle: ZAMAK-5

• Working temperature (Seals)

	NBR	Viton	EPDM
+	+100°C	+200°C	+150°C
-	-30°C	-10°C	-40°C

- **Applications:** Designed for Oil hydraulic Applications according to European Directive 97.23.EC Special for American market

• Sectors: Industrial, Agricultural.



MODEL STRUCTURE

Example;

471.1114 AE

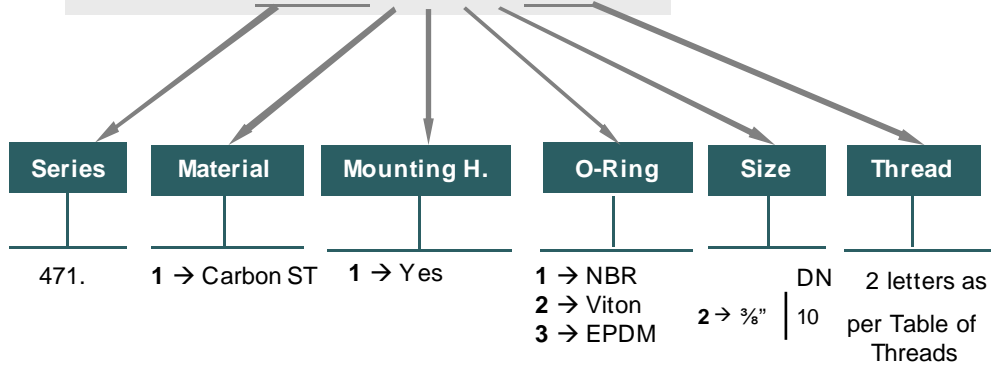

471-1







471 SERIES

EK3

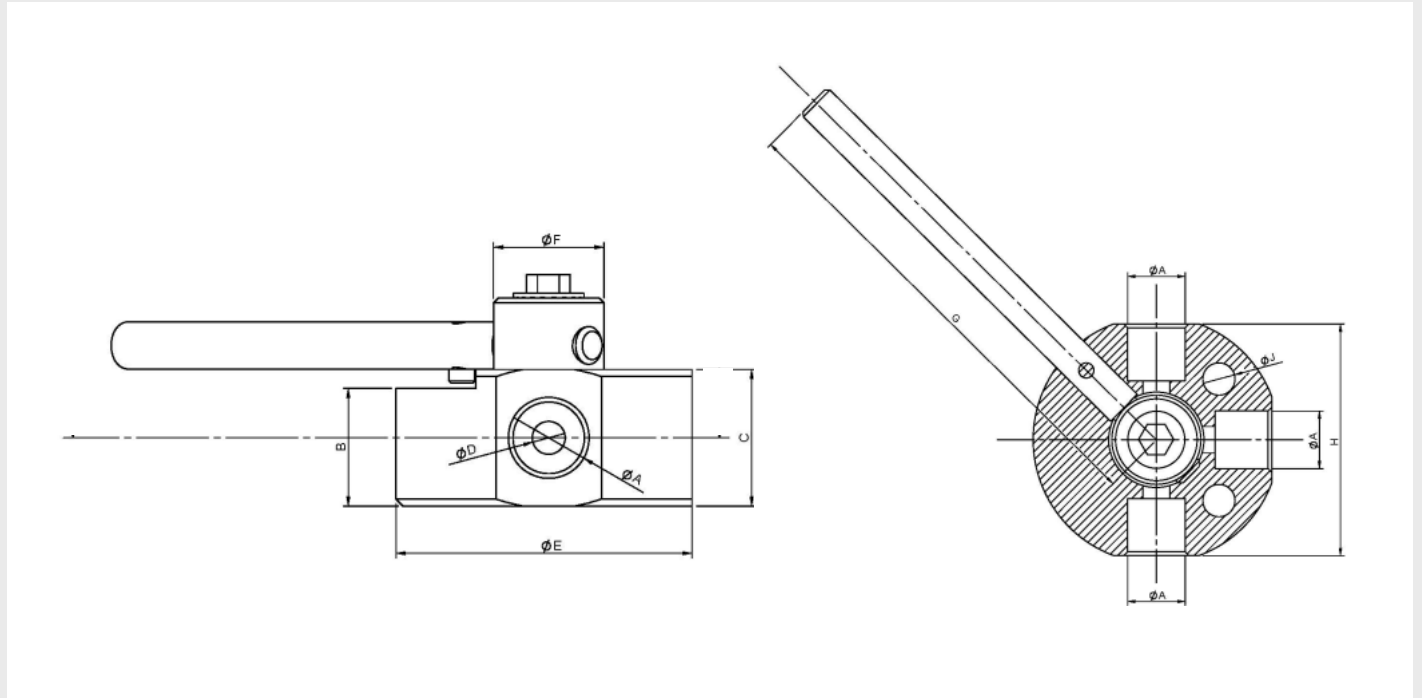
BSP



STANDARD MODEL

DN	F	REF.		Ø A	B	C	Ø D	Ø E	Ø F	G	H	I	Ø J
10	3/8" BSP	471.1112AC	190Bar	15,20	25	29	7	65	26,50	127,25	61	15,50	8,50

471-2





472 SERIES

VPN BSP



Aluminium manufacturing.
Designed for pneumatic systems in trucks.
BSP Threads, others upon request.

• Materials

Body: *Aluminium*

Inner parts: *Carbon Steel EN 10277-3*

Seals: *NBR*

Handle: *Carbon Steel EN 10277-3*

• Working temperature (Seals)

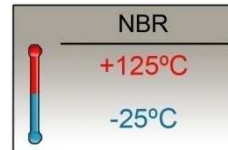

• **Applications:** Designed for Pneumatic Systems. Applications according to European Directive 97.23.EC

• **Sectors:** Trucks



MODEL STRUCTURE

Example;

472.611 AB

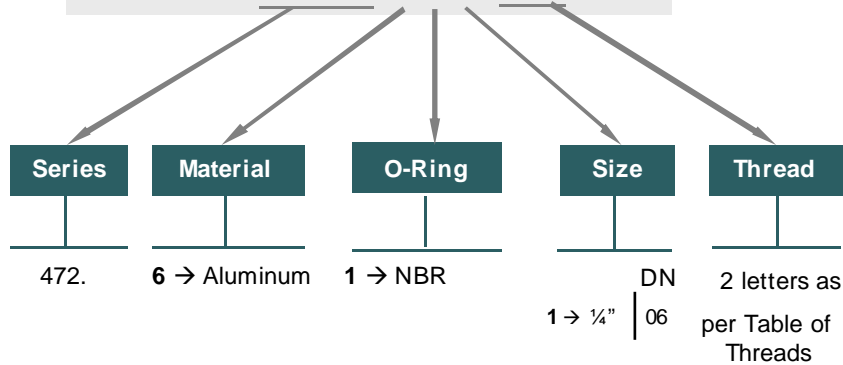

472-1





472 SERIES

VPN BSP

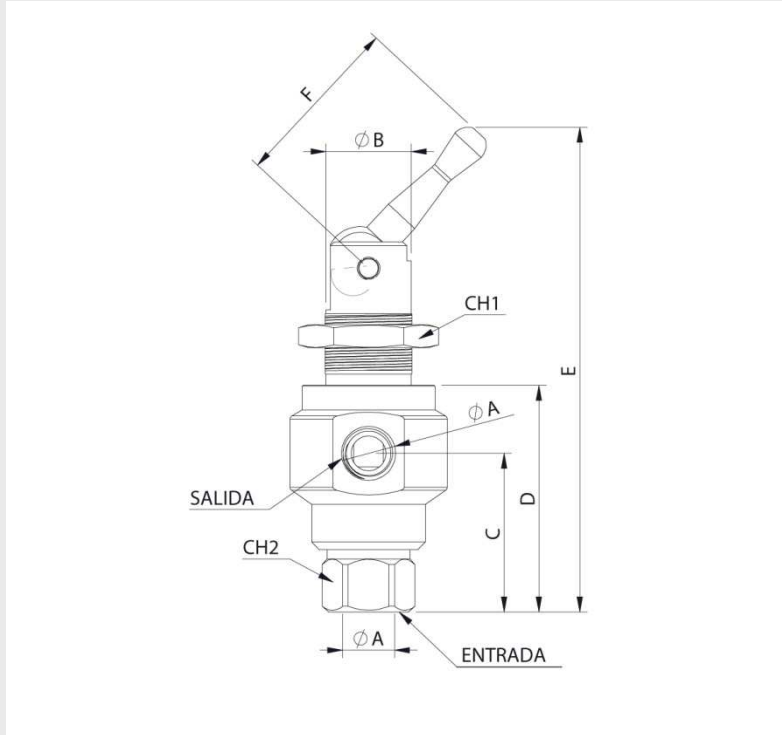

STANDARD MODEL

DN	Ø A	REF.		Ø B	C	D	E	F	CH2	CH1
06	1/4" BSP	472.611AB	15Bar	25	43	60,50	125	46	22	32

472-2





502 SERIES

VPC

BSP



Designed to act in case of hose breakage.
Block/Control charge's descent avoiding a sharp-fall pressure on the circuit.
BSP Threads, others available upon request.

• **Materials**

Carbon Steel EN -10277-3 / AISI 316L
Springs: Carbon Steel DIN 17233/84(B)

• **Sectors:** Industrial



• **Applications:** Designed for Oil hydraulic Applications according to European Directive 97.23.EC
Special for American market

MODEL STRUCTURE

Example;

502.19992AN

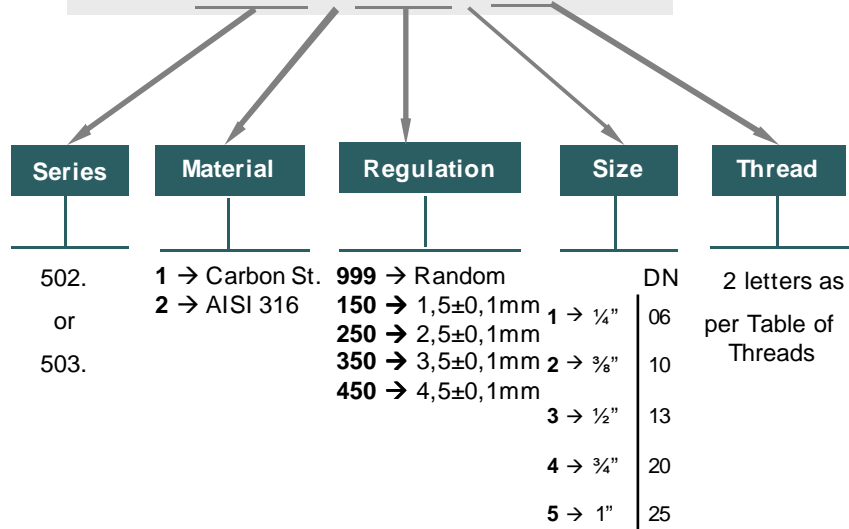

• Random regulation for VPC (999) although it is possible to regulate them upon request.





502 SERIES

VPC

BSP



OPERATION:

In normal position the disc is driven by the spring allowing fluid passage from Z to Z1.

In normal conditions, the fluid returns also free to tank from Z1 to Z.

When the fluid passage increases from Z1 to Z, and the reaction flow exceeds, the disc blocks the return to tank, preventing uncontrolled descent.

The user can adjust the reaction flow (T), according to specific needs of this safety valve.

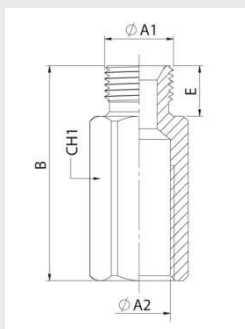

BODY M - F

DN	ØA1	ØA2	REF.	CH1	B	E
06	1/4" BSP M.	1/4" BSP	502.19991AM	19	50	12
10	3/8" BSP M.	3/8" BSP	502.19992AN	22	59	13
13	1/2" BSP M.	1/2" BSP	502.19993AO	27	65	15
20	3/4" BSP M.	3/4" BSP	502.19994AP	36	78	16
25	1" BSP M.	1" BSP	502.19995AQ	41	92	18



350Bar

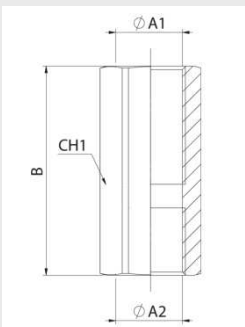

BODY F - F

DN	ØA1	ØA2	REF.	CH1	B
06	1/4" BSP	1/4" BSP	502.19991AB	19	48
10	3/8" BSP	3/8" BSP	502.19992AC	22	59
13	1/2" BSP	1/2" BSP	502.19993AD	27	62
20	3/4" BSP	3/4" BSP	502.19994AE	36	72
25	1" BSP	1" BSP	502.19995AF	41	86



350Bar

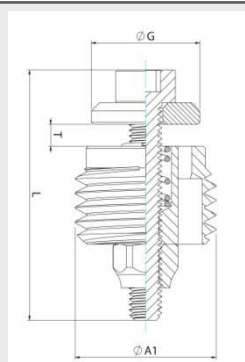

CARTRIDGE

DN	ØA1	REF.	ØG	L
06	1/4" BSP	503.19991AM	10	23
10	3/8" BSP	503.19992AN	13.80	23
13	1/2" BSP	503.19993AO	16	34
20	3/4" BSP	503.19994AP	20	34
25	1" BSP	503.19995AQ	24	43



350Bar

★ SPECIAL OPTIONS:

A hole for depressurization on the VPC valve can be delivered for minimum quantities upon request.

Adding a three number code at the end of the reference depending on the diameter of the hole.

Examples:

Ø6 mm → 060

Ø10 mm → 100



504 SERIES

ATR

CARBON STEEL / AISI 316
BSP / NPTF

Designed to avoid returns of the fluid inside the hydraulic circuit.

Metal closing system (without o-ring)

High pressure peak resistance.

Standard opening pressure 5psi. Special opening pressures available upon request.

• Materials

	CARBON STEEL	STAINLESS STEEL
Body	Carbon Steel EN-10277-3	AISI 316L
Seals	NBR, Viton or EPDM	NBR, Viton or EPDM
Springs	Carbon Steel DIN 17233/84(B)	AISI302 DIN 17224

• Working temperature (Seals)

	NBR	Viton	EPDM
+	+100°C	+200°C	+150°C
-	-30°C	-10°C	-40°C

• Sectors

Carbon Steel → Agricultural, Industrial.



Stainless Steel → Chemical, Industrial, Offshore.



• **Applications:** Designed for Oil hydraulic Applications according to European Directive 97.23/EC Special for American market

• Equivalence:

GROMELLE 4000

DMIC CVH

PARKER DC

SNAP TITE CPIFF

MODEL STRUCTURE

Example;

504. 110006 AG

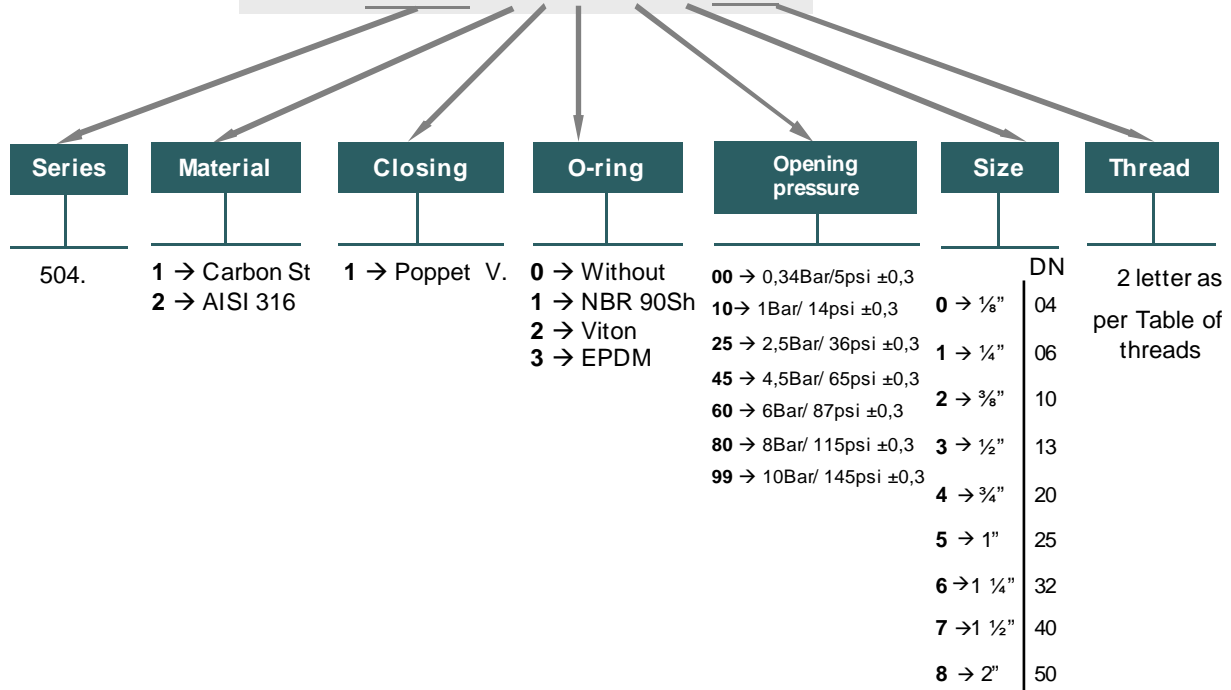

504-1





504 SERIES

ATR

CARBON STEEL / AISI 316
BSP / NPTF

STANDARD CARBON STEEL MODELS

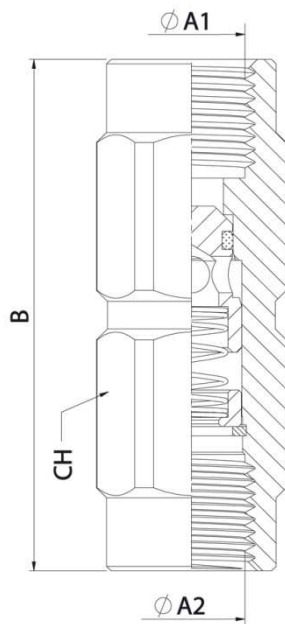

DN	ØA1/ ØA2	REF.		CH	B
04	1/8" BSP	504.110000AA	300Bar	14	44
	1/8" NPTF	504.110000BA			
06	1/4" BSP	504.110001AB		19	56
	1/4" NPTF	504.110001BB			
10	3/8" BSP	504.110002AC		22	70
	3/8" NPTF	504.110002BC			
13	1/2" BSP	504.110003AD		30	77
	1/2" NPTF	504.110003BD			
20	3/4" BSP	504.110004AE		36	90
	3/4" NPTF	504.110004BE			
25	1" BSP	504.110005AF		46	106
	1" NPTF	504.110005BF			
32	1 1/4" BSP	504.110006AG	55	125	
	1 1/4" NPTF	504.110006BG			
40	1 1/2" BSP	504.110007AH	60	140	
	1 1/2" NPTF	504.110007BH			
50	2" BSP	504.110008AI	75	160	
	2" NPTF	504.110008BI			

STANDARD STAINLESS STEEL MODELS

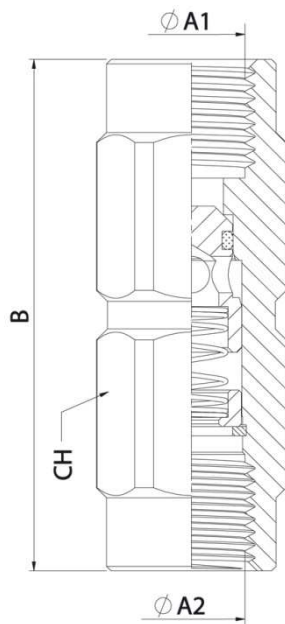

DN	ØA1/ ØA2	REF.		CH	B
04	1/8" BSP	504.210000AA	300Bar	14	44
	1/8" NPTF	504.210000BA			
06	1/4" BSP	504.210001AB		19	56
	1/4" NPTF	504.210001BB			
10	3/8" BSP	504.210002AC		22	70
	3/8" NPTF	504.210002BC			
13	1/2" BSP	504.210003AD		30	77
	1/2" NPTF	504.210003BD			
20	3/4" BSP	504.210004AE		36	90
	3/4" NPTF	504.210004BE			
25	1" BSP	504.210005AF		46	106
	1" NPTF	504.210005BF			
32	1 1/4" BSP	504.210006AG	55	125	
	1 1/4" NPTF	504.210006BG			
40	1 1/2" BSP	504.210007AH	60	140	
	1 1/2" NPTF	504.210007BH			
50	2" BSP	504.210008AI	75	160	
	2" NPTF	504.210008BI			

★ **SPECIAL OPTIONS:**

ATR Check Valves that require special opening pressures can be delivered upon request by minimum quantities.



504 SERIES

ATR

CARBON STEEL / AISI 316
BSP / NPTF

TECHNICAL DATA

DN	Max. Rated Flow	Working Pressure	Max. Working Pressure *
	l/m / GPM	bar / psi	bar / psi
04	8 / 2,11	300 / 4350	1200 / 17400
06	26 / 6,87	300 / 4350	1200 / 17400
10	44 / 11,6	300 / 4350	1200 / 17400
13	90 / 23,85	300 / 4350	1200 / 17400
20	152 / 40,2	300 / 4350	1200 / 17400
25	200 / 52,8	300 / 4350	1200 / 17400
32	370 / 97,8	300 / 4350	1200 / 17400
40	598 / 158	300 / 4350	1200 / 17400
50	875 / 231	200 / 2900	800 / 11600

* Safety factor 1:4

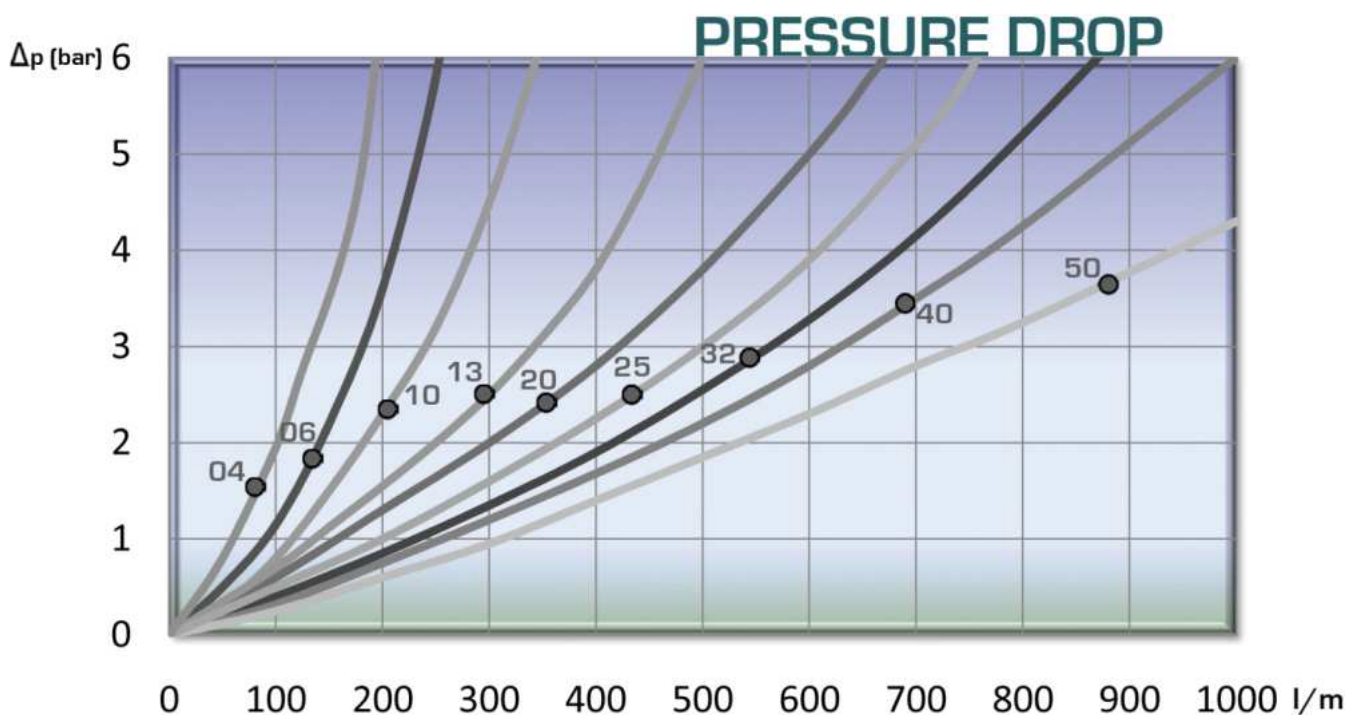

504-3



505 SERIES

ATR

BSP
M - F



Designed to avoid returns of the fluid inside the hydraulic circuit.

Metal closing system (without o-ring)

High pressure peak resistance.

Standard opening pressure 5psi. Special opening pressures available upon request.

• Materials

Carbon Steel EN10277-3 / Inox AISI 316L

Springs: Carbon Steel DIN 17233/84(B)

O-rings: NBR, Viton or EPDM

- **Applications:** Designed for Oil hydraulic Applications according to European Directive 97.23.EC Special for American market

• Equivalence:

GROMELLE 4000

DMIC CVH

PARKER DC

SNAP TITE CPIFF

• Working temperature (Seals)

	NBR	Viton	EPDM
	+100°C	+200°C	+150°C
	-30°C	-10°C	-40°C

- **Sectors:** Agricultural, Industrial.



MODEL STRUCTURE

Example;

505.210008 BI

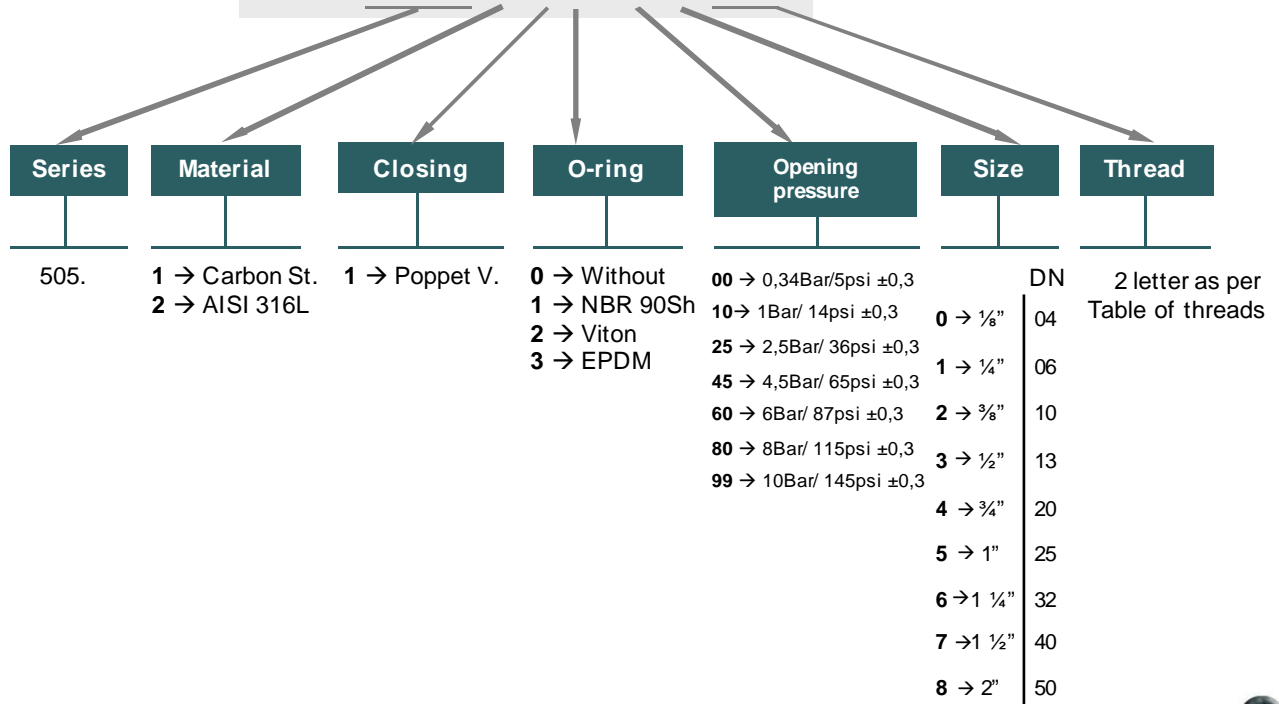

505-1







505 SERIES

ATR

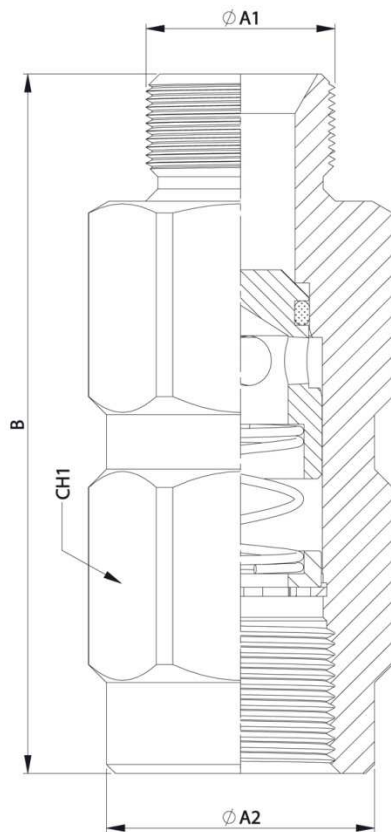
BSP
M - F



STANDARD MODELS

DN	ØA1	ØA2	REF.		CH1	B
04	1/8" BSP M.	1/8" BSP	505.110000AL	300Bar	14	44
06	1/4" BSP M.	1/4" BSP	505.110001AM		19	56
10	3/8" BSP M.	3/8" BSP	505.110002AN		22	70
13	1/2" BSP M.	1/2" BSP	505.110003AO		30	77
20	3/4" BSP M.	3/4" BSP	505.110004AP		36	90
25	1" BSP M.	1" BSP	505.110005AQ		46	106
32	1 1/4" BSP M.	1 1/4" BSP	505.110006AR		55	125
40	1 1/2" BSP M.	1 1/2" BSP	505.110007AS	60	140	
50	2" BSP M.	2" BSP	505.110008AT	200Bar	75	160

★ SPECIAL OPTIONS:

ATR Check Valves that require special opening pressures can be delivered upon request by minimum quantities.



505 SERIES

ATR

BSP
M - F



TECHNICAL DATA			
DN	Max. Rated Flow	Working Pressure	Max. Working Pressure *
04	8 / 2,11	300 / 4350	1200 / 17400
06	26 / 6,87	300 / 4350	1200 / 17400
10	44 / 11,6	300 / 4350	1200 / 17400
13	90 / 23,85	300 / 4350	1200 / 17400
20	152 / 40,2	300 / 4350	1200 / 17400
25	200 / 52,8	300 / 4350	1200 / 17400
32	370 / 97,8	300 / 4350	1200 / 17400
40	598 / 158	300 / 4350	1200 / 17400
50	875 / 231	200 / 2900	800 / 11600

* Safety factor 1:4

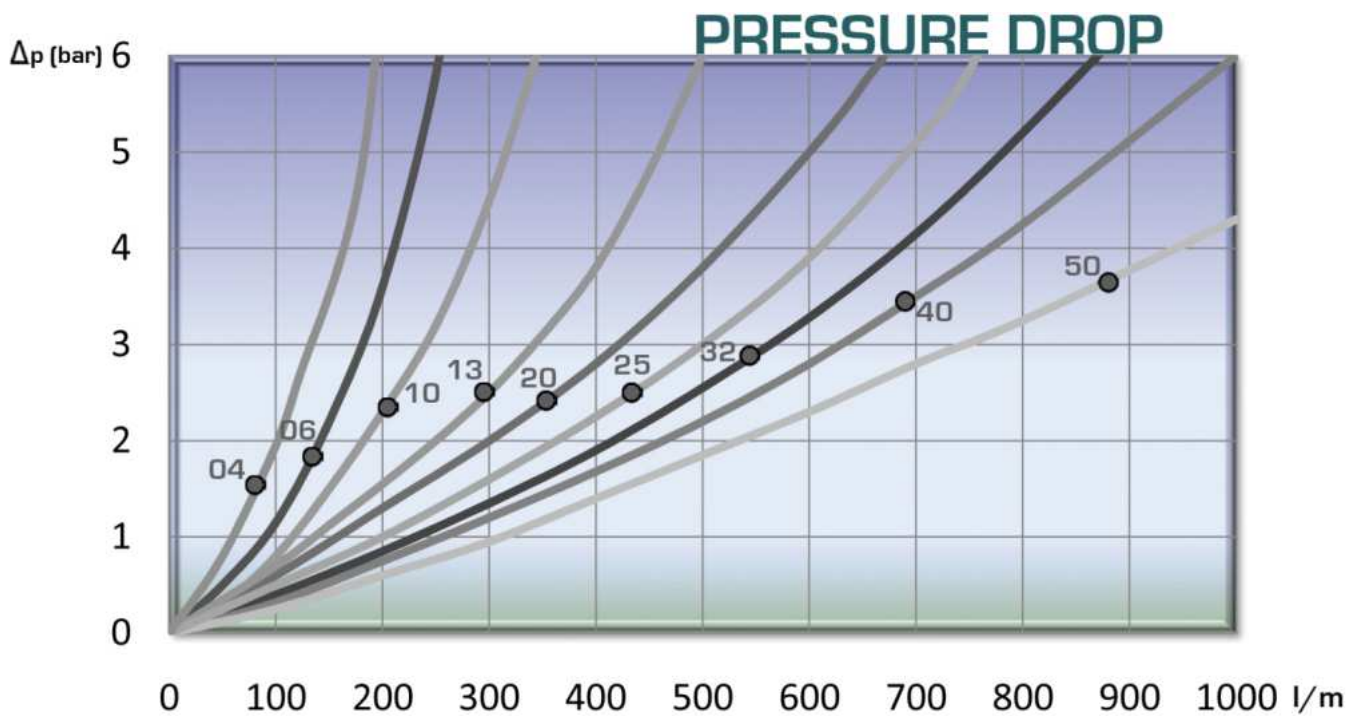

505-3





999 SERIES THREADS



BSP			NPTF			BSPT		
THREAD (inches)	FEMALE	MALE	THREAD (inches)	FEMALE	MALE	THREAD (inches)	FEMALE	MALE
1/8"	AA	AL	1/8"	BA	BL	1/8"	DA	DL
1/4"	AB	AM	1/4"	BB	BM	1/4"	DB	DM
3/8"	AC	AN	3/8"	BC	BN	3/8"	DC	DN
1/2"	AD	AO	1/2"	BD	BO	1/2"	DD	DO
3/4"	AE	AP	3/4"	BE	BP	3/4"	DE	DP
1"	AF	AQ	1"	BF	BQ	1"	DF	DQ
1 1/4"	AG	AR	1 1/4"	BG	BR	1 1/4"	DG	DR
1 1/2"	AH	AS	1 1/2"	BH	BS	1 1/2"	DH	DS
2"	AI	AT	2"	BI	BT	2"	DI	DT
2 1/2"	AJ	AU	2 1/2"	BJ	BU			
3"	AK	AV	3"	BK	BV			

BSP Bulkhead		DIN3852		UNF			SPECIALS	
THREAD		THREAD		THREAD	ORB FEMALE	MALE	THREAD	
1/8"	CL	M14x1,5	NC	7/16"-20UNF	GA	HA	KFA	M20x1,5 Ø13,5
1/4"	CM	M16x1,5	ND	9/16"-18UNF	GC	HC	KFB	M20x1,5 Cone 60°
3/8"	CN	M18x1,5	NE	11/16"-16UN	GE	HE	HFA	3/4"-16M. Without 37°
1/2"	CO	M20x1,5	NF	3/4"-16UNF	GF	HF	JDA	M16x1,5 Bulkhead M20x1,5
3/4"	CP	M22x1,5	NG	13/16"-16UN	GG	HG	GFA	3/4"-16UNF cylinder
1"	CQ	M24x1,5	NH	7/8"-14UNF	GH	HH	JGA	M22x1,5 Prolonged
1 1/4"	CR	M26x1,5	NI	1 1/16"-12UN	GK	HK	JGB	M22x1,5 15L Long. Hex 35mm
1 1/2"	CS	M30x2	NJ	1 3/16"-12UN	GM	HM	LGA	M22 Bulkhead Prolonged
2"	CT	M36x2	NK	1 5/16"-12UN	GO	HO		
		M42x2	NL	1 7/16"-12UN	GQ	HQ		
		M45x2	NM	1 5/8"-12UN	GT	HT		
		M52x2	NN	1 11/16"-12UN	GU	HU		
		M30x1,5	NS	1 7/8"-12UN	GV	HV		

DIN2353				DIN2353 Bulkhead			
THREAD	L	THREAD	S	THREAD	L	THREAD	S
M12x1,5 6L	JB	M16x1,5 8S	KD	M12x1,5 6L	LB	M16x1,5 8S	MD
M14x1,5 8L	JC	M18x1,5 10S	KE	M14x1,5 8L	LC	M18x1,5 10S	ME
M16x1,5 10L	JD	M20x1,5 12S	KF	M16x1,5 10L	LD	M20x1,5 12S	MF
M18x1,5 12L	JE	M22x1,5 14S	KG	M18x1,5 12L	LE	M22x1,5 14S	MG
M22x1,5 15L	JG	M24x1,5 16S	KH	M22x1,5 15L	LG	M24x1,5 16S	MH
M26x1,5 18L	JI	M30x2 20S	KJ	M26x1,5 18L	LI	M30x2 20S	MJ
M30x2 22L	JJ	M36x2 25S	KK	M30x2 22L	LJ	M36x2 25S	MK
M36x2 28L	JK	M42x2 30S	KL	M36x2 28L	LK	M42x2 30S	ML
M45x2 35L	JM	M52x2 38S	KN	M45x2 35L	LM	M52x2 38S	MN





C/ Berguedà nº 14-16 P.I. Can Bernadés Subirà
08130 Santa Perpètua de la Mogoda
BARCELONA (SPAIN)
Tel / Phone +34 93 560 79 43
Fax +34 93 574 30 94